

**ANALYSIS of the  
FOUR-BAR LINKAGE**

**Its Application to the  
Synthesis of Mechanisms**

from  
Design of Machinery 4ed  
by Robert L. Norton  
McGraw-Hill  
Copyright 2008

# ANALYSIS of the FOUR-BAR LINKAGE

## Its Application to the Synthesis of Mechanisms

---

*John A. Hrones*

PROFESSOR OF  
MECHANICAL ENGINEERING

*George L. Nelson*

ASSISTANT PROFESSOR OF  
MECHANICAL ENGINEERING

THE MASSACHUSETTS INSTITUTE OF TECHNOLOGY

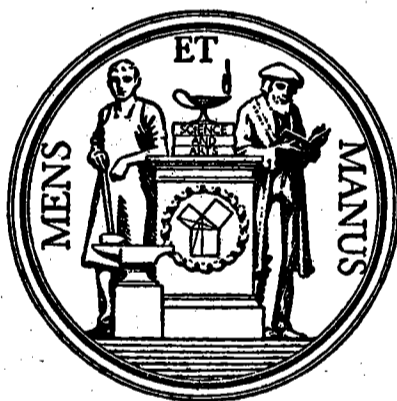

Published jointly by THE TECHNOLOGY PRESS of  
THE MASSACHUSETTS INSTITUTE of TECHNOLOGY  
and JOHN WILEY & SONS, INC., NEW YORK  
CHAPMAN & HALL, LIMITED, LONDON

from  
Design of Machinery 4ed  
by Robert L. Norton  
McGraw-Hill  
Copyright 2008

## The Four-Bar Linkage

Determinate linkage motion results when the number of independent input angular motions is two less than the number of links. All links are assumed to be rigid members and are pin-connected to one another. Freedom of relative angular motion exists between any two members at the pin joint. The minimum number of links which will permit relative motion between links is four. In the majority of applications one of the links (the line of centers) is stationary while a second link (the driving crank) is driven from an outside motion source. The motion of the remaining two links is a function of the geometry of the linkage and the motion of the driving crank and the line of centers.

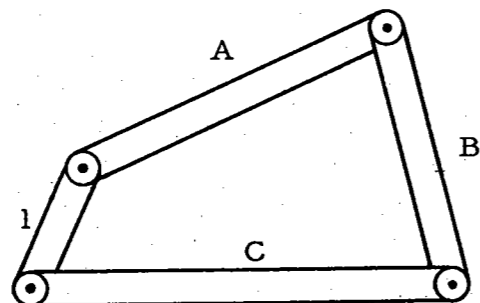

Four Bar Linkage

Fig. 1

A four-bar linkage is schematically shown in figure 1. It consists of the four links having pin-to-pin lengths of 1,  $A$ ,  $B$ , and  $C$ . The geometry of the linkage is determined by the three ratios  $A/1$ ,  $B/1$ , and  $C/1$ .

Up to this point the four-bar linkage has been represented as consisting of four lines. Actually, each member is a solid body which from purely theoretical aspects can be considered as being of indefinite extent (figure 6).

Manufacturing and design considerations place very real limitations on the size of the members. Within these limits a wide variety of motions are available. In this volume the points indicated in figure 6 on the connecting rod included within a rectangular boundary extending a distance equal to the driving crank length in directions parallel to and at right angles to the centerline of the connecting rod have been investigated and their trajectories and velocities presented. Thus, for each series of linkage ratios the behavior of the points indicated in figure 6 has been studied and the results published for class (a) type linkage operation.

### Classes of Linkage Operation

The basic four-bar linkage is shown in figure 1. The fixed member  $C$  is the line of centers. Pinned to the extremities of  $C$  are the cranks 1 and  $B$ . The moving ends of the cranks are joined by the fourth bar, the connecting rod  $A$ . The driving crank 1 and the follower crank  $B$  move in rotation about their fixed axes located on the line of centers  $C$ . The connecting rod  $A$  in general moves in combined translation and rotation.

The nature of the motion of the connecting rod  $A$  and the follower crank  $B$  relative to the line of centers  $C$  for a given input motion to the driving crank 1 is determined by the three basic link length ratios  $A/1$ ;  $B/1$ ;  $C/1$ , which will hereafter be designated by  $A$ ,  $B$ , and  $C$ . The shortest link will always be designated as unity. The remaining links will be labeled  $A$ ,  $B$ , and  $C$  in order around the linkage. It is convenient to separate the geometrically possible motions into three main categories of operation.

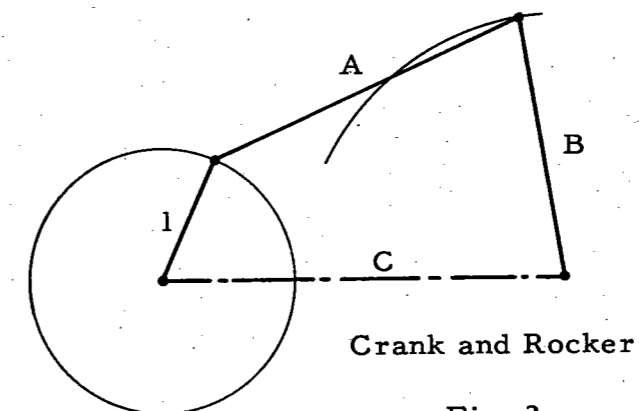

Crank and Rocker

Fig. 2

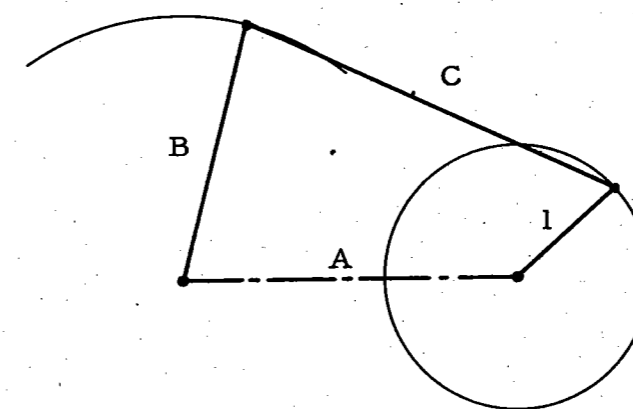

Crank and Rocker

Fig. 3

- Class (a) One crank is capable of rotation through a complete revolution while the second crank can only oscillate.
- Class (b) Both cranks are capable of rotating through 360°.
- Class (c) Both cranks oscillate, but neither can rotate through a complete revolution.

The above classifications arise from a consideration of the motions of the various links relative to the fixed link. As any link can be fixed arbitrarily the classification of a given linkage is dependent upon the choice of a fixed member. In figure 2, link *C* is fixed. Crank 1 can make a complete revolution while the crank *B* can only oscillate. The linkage is operating as a class (a) unit commonly known as a crank-and-rocker linkage. Similarly, if link *A* is fixed (figure 3), Class (a) operation results. If link 1 is fixed (figure 4), both cranks are capable of full 360° rotation and class (b) operation results. This linkage is often referred to as a drag link mechanism. If link *B* is fixed (figure 5), the two cranks *A* and *C* can only oscillate, hence class (c) operation takes place.

Though the above classifications are helpful in design, it is important to realize that the relative motion of any link to the remaining members of the linkage is the same, regardless of which member is fixed.

Criteria for determining the class of operation when link ratios are known are listed below.

Class (a) (crank and rocker mechanism).

- (1) Drive crank must be the shortest link (1).
- (2)  $C < (A + B - 1)$ .
- (3)  $C > (|A - B| + 1)$ .

Class (b) (drag link mechanism).

- (1) Line of centers must be the shortest link (1).
- (2)  $C < (A + B - 1)$ .
- (3)  $C > (|A - B| + 1)$ . Same as class (a).

Class (c) (double rocker mechanism).

- (1) All cases where the connecting rod is the shortest link (1).
- (2) All linkages in which (2) and (3) for classes (a) and (b) are not satisfied.

The above conditions have been graphically expressed in figure 7. The ratio *C* is the ordinate; ratio *B* is the abscissa; and values of ratio *A* are plotted as 45° lines. For a given value of *A*, if the point specified by the coordinates *B* and *C* falls inside the oblique rectangular space bounded by the lines of constant *A*, the linkage will operate in class (a) or (b): class (a) if the shortest link is made a crank; class (b) if the shortest link is made the line of centers. If the point determined by the coordinates

\* $|A - B|$  = absolute value of ( $A - B$ ).

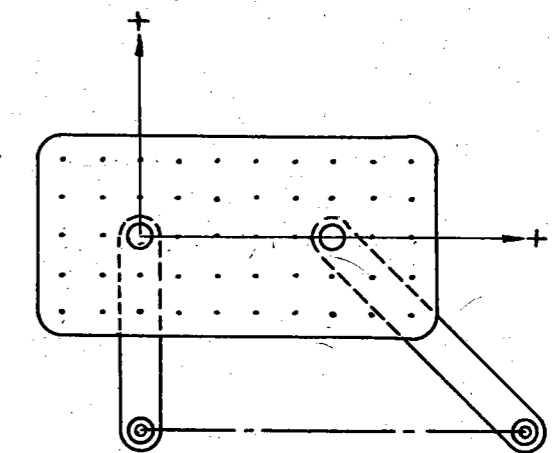
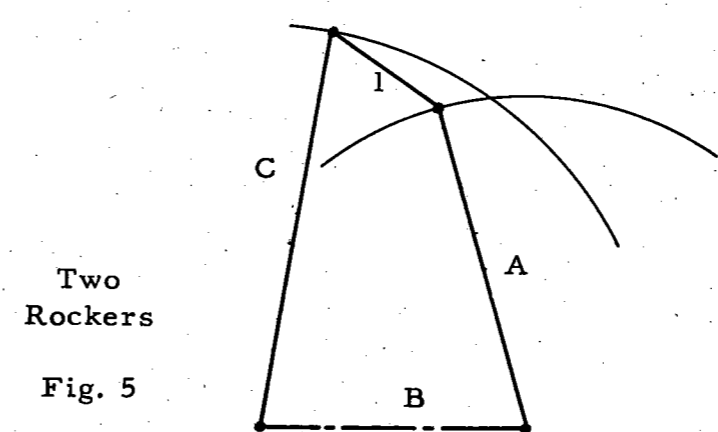
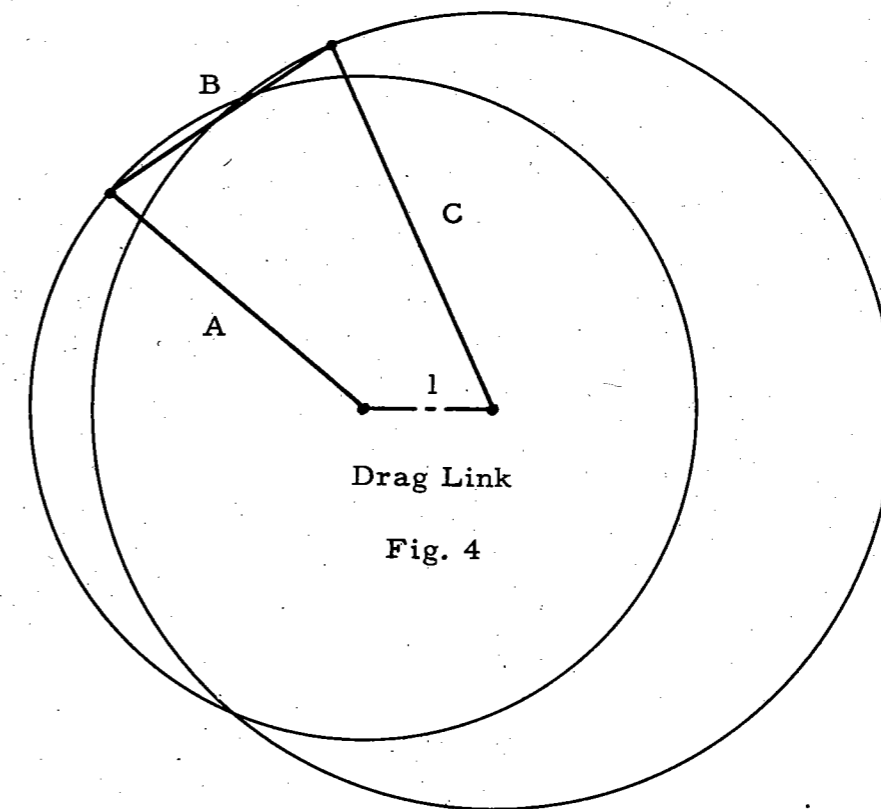

from  
 Design of Machinery 4ed  
 by Robert L. Norton  
 McGraw-Hill  
 Copyright 2008

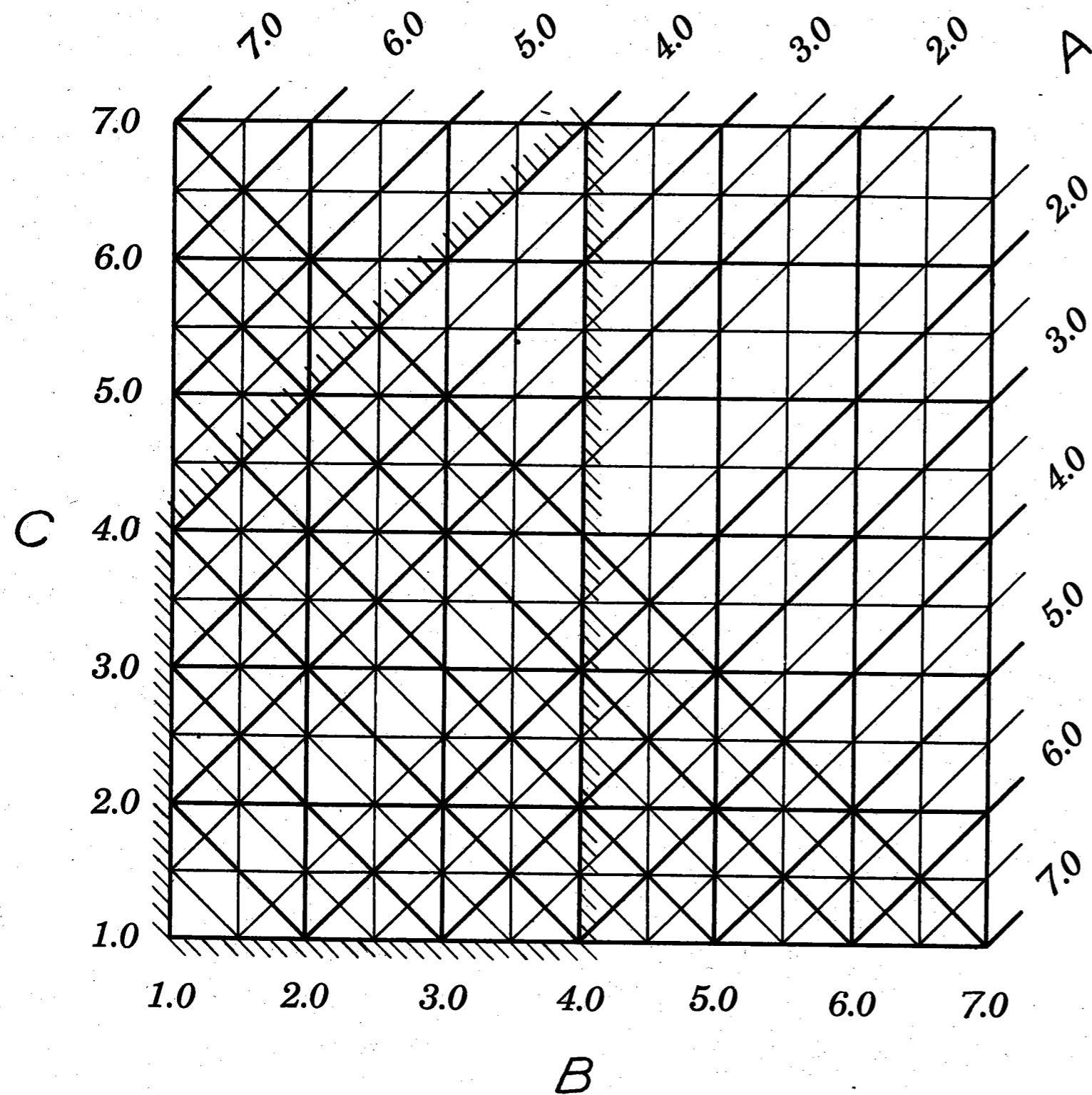

Fig. 7

FOUR-BAR LINKAGE CLASSIFICATION CHART

Linkage whose ratios *B* and *C* determine a point which lies in the oblique rectangular area bounded by lines of constant ratio *A* operates as a Crank and Rocker or as a Drag Link.

*B* and *C* falls outside the rectangular area bounded by the lines of constant *A*, class (c) operation is indicated. Crank and rocker linkages [class (a) operation] included in heavily outlined area are covered in this book.

**Example:**

Data: Drive crank = 4"; Connecting Rod = 10"  
Follower Crank = 8"; Line of Centers = 12"

- Find: (1) Class of operation.  
(2) Variation in link ratios possible without changing class of operation.

Solution (see figure 8):

$$A = \frac{10}{4} = 2.5; \quad B = \frac{8}{4} = 2; \quad C = \frac{12}{4} = 3.$$

Drive crank is the shortest link. Refer to figure 7. Point (*B* = 2, *C* = 3) falls within oblique rectangular area bounded by lines *A* = 2.5.

Therefore class (a) operation is indicated

- 1, *A* = 2.5, *B* = 2 *C* may be varied from 1.5 to 3.5
- 1, *A* = 2.5, *C* = 3 *B* may be varied from 1.5 to 4.5
- 1, *B* = 2, *C* = 3 *A* may be varied from 2 to 4

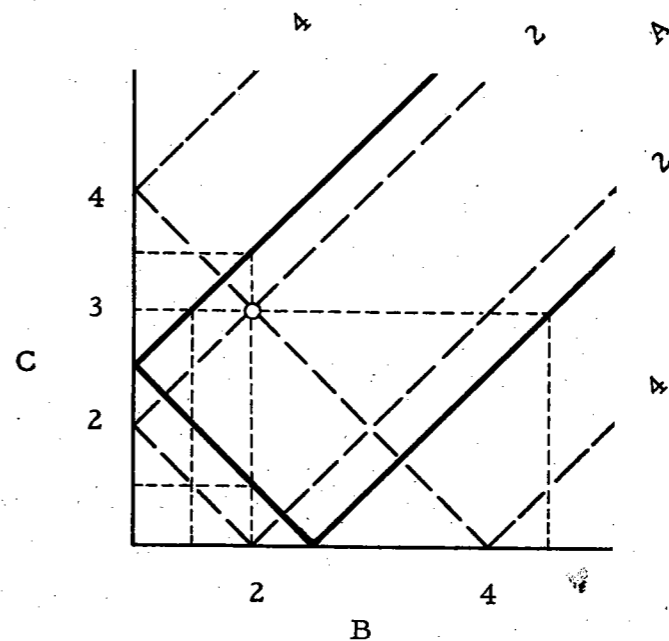

Fig. 8

### Mathematical Relationships

*Driver-Follower Crank.* (See figure 9.) The follower crank angular position is given by 4.

$$\begin{aligned}\psi &= a_1 + a_2 \\ a_1 &= \tan^{-1} \frac{\sin \theta}{C + \cos \theta} \\ a_2 &= \cos^{-1} \frac{K^2 + 2C \cos \theta}{2BL} \\ K^2 &= 1 + B^2 + C^2 - A^2 \\ L^2 &= 1 + C^2 + 2C \cos \theta \\ M^2 &= K^2 + 2C \cos \theta \\ S^2 &= \sqrt{4B^2L^2 - M^4} \\ \psi &= \tan^{-1} \frac{\sin \theta}{C + \cos \theta} + \cos^{-1} \frac{K^2 + 2C \cos \theta}{2BL}\end{aligned}\quad (1)$$

Differentiating equation 1 with respect to time yields the following equation for the velocity of the follower crank:

$$\frac{d\psi}{dt} = \frac{d\theta}{dt} \left[ \frac{1}{L^2} (C \cos \theta + 1) + \frac{C \sin \theta}{S^2} \left( 2 + \frac{M^2}{L^2} \right) \right]$$

A second differentiation yields an expression for the angular acceleration of the follower crank:

$$\begin{aligned}\frac{d^2\psi}{dt^2} &= \frac{d^2\theta}{dt^2} \left[ \frac{1}{L^2} (C \cos \theta + 1) + \frac{C \sin \theta}{S^2} \left( 2 + \frac{M^2}{L^2} \right) \right] \\ &+ \left[ \left( 2 + \frac{M^2}{L^2} \right) \left( \frac{2C^2 \sin^2 \theta (2B^2 - M^2)}{S^6} + \frac{C \cos \theta}{S^2} \right) \right. \\ &\left. - \frac{2C^2 \sin^2 \theta}{L^2 S^2} \left( 1 - \frac{M^2}{L^2} \right) - \frac{C \sin \theta}{L^2} \left( 1 - \frac{2(C \cos \theta + 1)}{L^2} \right) \right] \left( \frac{d\theta}{dt} \right)^2.\end{aligned}$$

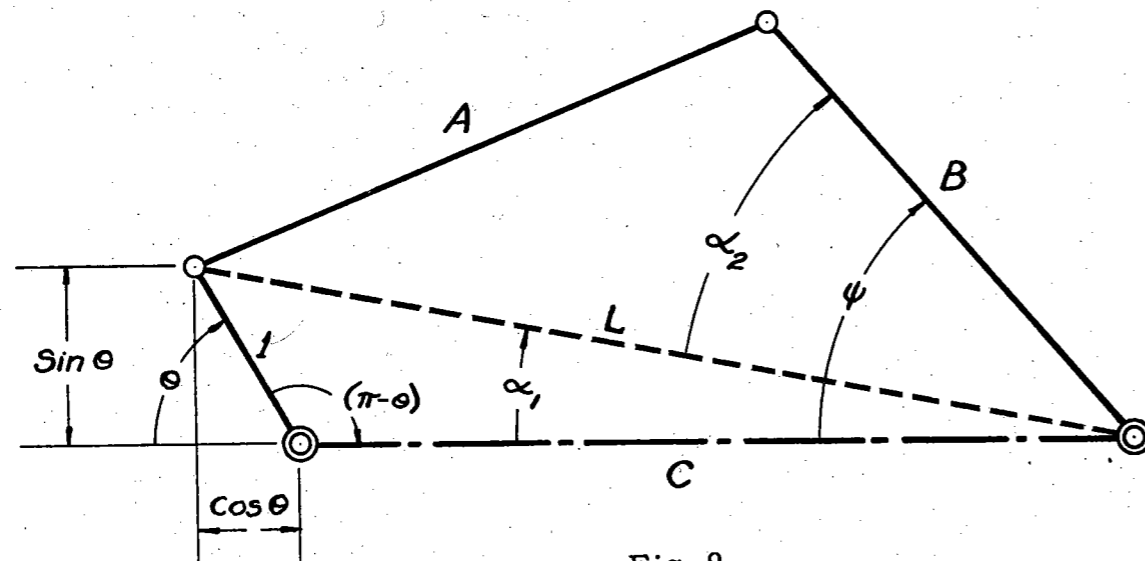

Fig. 9

*Motion of Points on Connecting Rod.* The relationships for displacement, velocity, and acceleration of a point located anywhere on the connecting rod are considerably more cumbersome than the above equations and are given in reference 1.

**Illustrative Examples.** (See reference 2.)

1. *Dwell Period from Straight-Line Path.* Figure 10 shows the path of a point on the connecting rod of a linkage which is approximately straight between points *a* and *b*. A rotation of  $55^\circ$  of the drive crank produces this straight portion. This is indicated by the eleven dashes which constitute the path lying between *a* and *b*.

If the point having this displacement path drives a member with a radial slot constrained to rotate about the fixed point *c*, an angular motion of  $27^\circ$  will result. In terms of drive crank angle there will be a  $55^\circ$  dwell, a  $220^\circ$  forward stroke, and an  $85^\circ$  return stroke. These figures are obtained directly from the trajectory by counting the number of dashes in each phase of the motion and multiplying by  $5^\circ$ .

If the pivot of the rotating link is located at *d* the total angular motion of the link is  $20^\circ$ . At a uniform drive crank speed approximately one-half of each cycle is used for the forward stroke, one-third for the return stroke, and one-sixth of each cycle for the dwell.

An alternative method of obtaining a dwell is to drive a "scotch yoke," a member slotted parallel to the straight portion *ab* but constrained to move in the direction *ef* perpendicular to *ab*. In this case the ratio of forward return stroke is not adjustable and is equal to 51/21 or 2.4. The ratio of the length of stroke to drive crank length is 1.37.

2. *Dwell Period from Circular-Line Path.* Figure 11 shows the path of a point on the connecting rod of a four-bar linkage whose basic ratios are 4; 2.5; 3.5. Between points *a* and *b* an approximate circular arc exists over a  $90^\circ$  drive crank angle displacement. Link *ac* pinned to the midpoint of the connecting rod drives a bell crank rotating about the same fixed axis as the drive crank. Link proportions are selected such that *c* is the center of curvature of the arc *ab*. The bell crank has a dwell period of one-fourth the total cycle and a total angle of travel of  $34^\circ$  with approximately equal times for advance and return.

The time ratio of forward to return stroke and the angle of oscillation can be adjusted by choosing other locations for the bell crank fixed axis, with corresponding changes in the length of the bell crank arm so that *c* remains the center of curvature of the arc *ab*. For instance, it is possible using this linkage to locate the bell crank axis at the fixed axis of the follower crank. Care must be taken to avoid a dead center position between the link *ac* and the bell crank arm to which it is pinned.

The same fundamental linkage can be employed to produce a straight line reciprocating motion with the same dwell period at the end of the

stroke. Substitute for the bell crank a slider constrained to move in a fixed straight slot passing through point  $c$ . Adjust the direction of this slot to obtain the desired time ratio of forward to return stroke. For example, using the line  $cd$  as the axis of the slot, the slider will dwell at point  $c$  for  $90^\circ$ , advance to point  $d$  in  $150^\circ$ , and return to point  $c$  in  $120^\circ$  rotation of the drive crank.

3. *Computer Linkages.* Four-bar linkages are often used as computers. Because of the infinite number of output-input relationships available a wide variety of functions can be represented over limited ranges of the variables appearing in the desired functions. Where a high degree of accuracy is required more than one four-bar linkage is often necessary. In this event the primary linkage approximates the desired relationship while additional linkages apply corrections to bring the maximum errors within the tolerance limits required. (See reference 3.)

Figure 12 shows a linkage which closely satisfies the function  $\phi = \frac{1}{2} \left[ \frac{\theta}{5} \right]^{1.5}$  over a range of  $\theta$  from  $0$  to  $55^\circ$ , when used as indicated below. In finding this mechanism the procedure was as follows. The drive crank angle was assumed to be the variable  $\theta$ . The value of  $\phi$  corresponding to values of  $\theta$  from  $0$  to  $75^\circ$  at  $5^\circ$  intervals was calculated. The calculated angular positions  $\phi$  were then accurately laid out on transparent paper. Repeated superposition of this layout on various charts resulted in finding a trajectory on which the lines representing the angular position  $\phi$  (of the overlay) fell on successive dash terminals. The point on this particular linkage giving this desired result can be used to drive a radially slotted member pivoted at the intersection of the lines on the overlay sheet.

The selected linkage has the basic ratios 2; 3; 2.5. The drive point on the connecting rod has the coordinate location +1.5, +1. The slotted member is pivoted at  $a$ . Within the range of  $\theta$  from  $0$  to  $55^\circ$  a good representation of  $\phi$  is obtained.

Figure 13 shows a linkage in which the output position is the logarithm of the input position over a limited range. As in the previous problem an overlay was constructed and the charts searched for satisfactory matching of the overlay over the desired range. In the mechanism shown, the radially slotted output member pivoted at  $a$  has angular displacements proportional to the logarithm of the drive crank displacement in the range of positions 1 to 10. Except at position 1 the accuracy is good. Two linkages of this type feeding a differential unit could be used as a multiplier. The basic linkage ratios are 2.5, 2.5, and 1.5. The coordinate location of the point on the connecting rod is +1.5, +1.

4. *Double Oscillating Crank.* A slotted crank whose frequency of oscillation is twice that of the drive crank is shown in figure 14. It is

driven by a point on the connecting rod whose trajectory exhibits an intersection. The two output oscillations can differ in amplitude and time. Figure 14 illustrates the special case where each oscillation is of the same amplitude. The pivot of the output member is located at point  $a$ . The time required for each part of the cycle is obtained by counting the dashes between the points of tangency  $b$ ,  $c$ ,  $d$ , and  $e$  and is given in the table below. The linkage has the basic ratios 2, 2.5, and 2. The drive point is at the coordinate location (+1, -1).

Stroke	Path	Dashes	Drive Crank, Degrees
1st forward	BC	10	50
1st return	CD	18	90
2d forward	DE	27	135
2d return	EB	17	85

5. *Symmetrical-Motion Paths.* In a number of applications it is desirable to obtain a path which is symmetrical with respect to some reference line. Linkages where the connecting rod and follower crank are of equal length ( $A = B$ ) have points on the connecting rod whose trajectories meet this condition. The locus of such points is a circle of radius  $A$  on the connecting rod with its center at the moving end of the follower crank.

Figure 15 shows the paths of twelve points on the connecting rod of a four-bar linkage with the basic ratios 2; 2; 2.5. The points are equally spaced on the dashed circle. The trajectory of each point is symmetrical about the straight line passing through the follower crank fixed axis and the zero position of the trajectory. The twelve trajectories illustrate a typical set of symmetrical-motion paths and show the great variety of curves available for use where symmetry of forward and return stroke is essential.

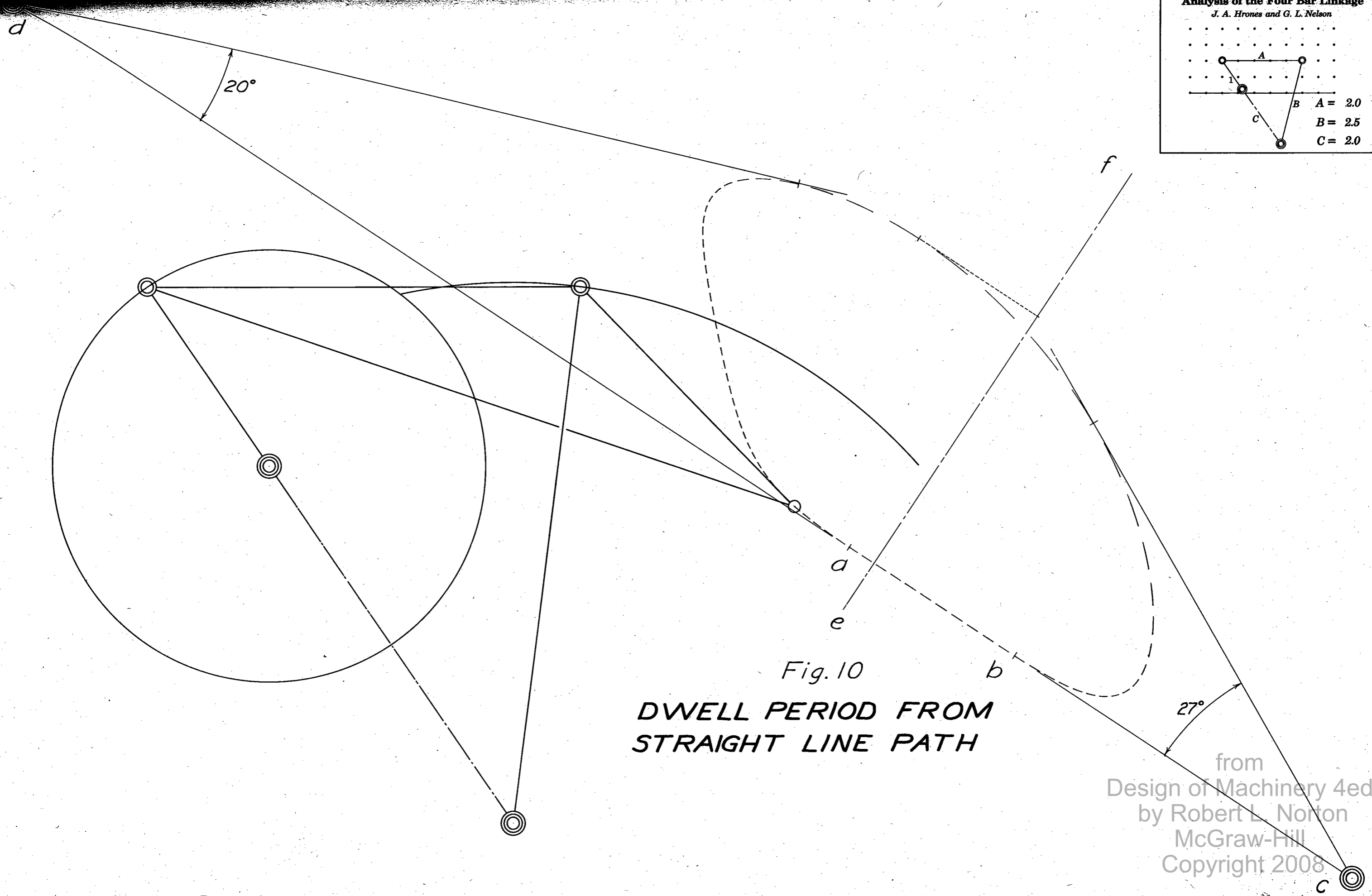
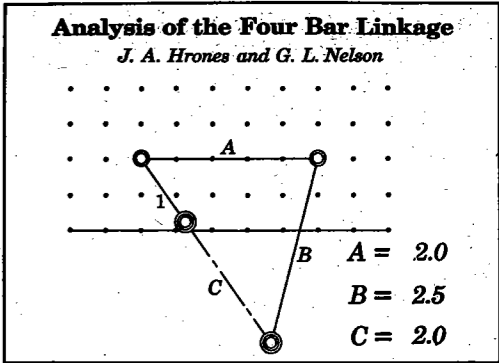

Fig. 10  
**DWELL PERIOD FROM  
 STRAIGHT LINE PATH**

from  
 Design of Machinery 4ed  
 by Robert L. Norton  
 McGraw-Hill  
 Copyright 2008



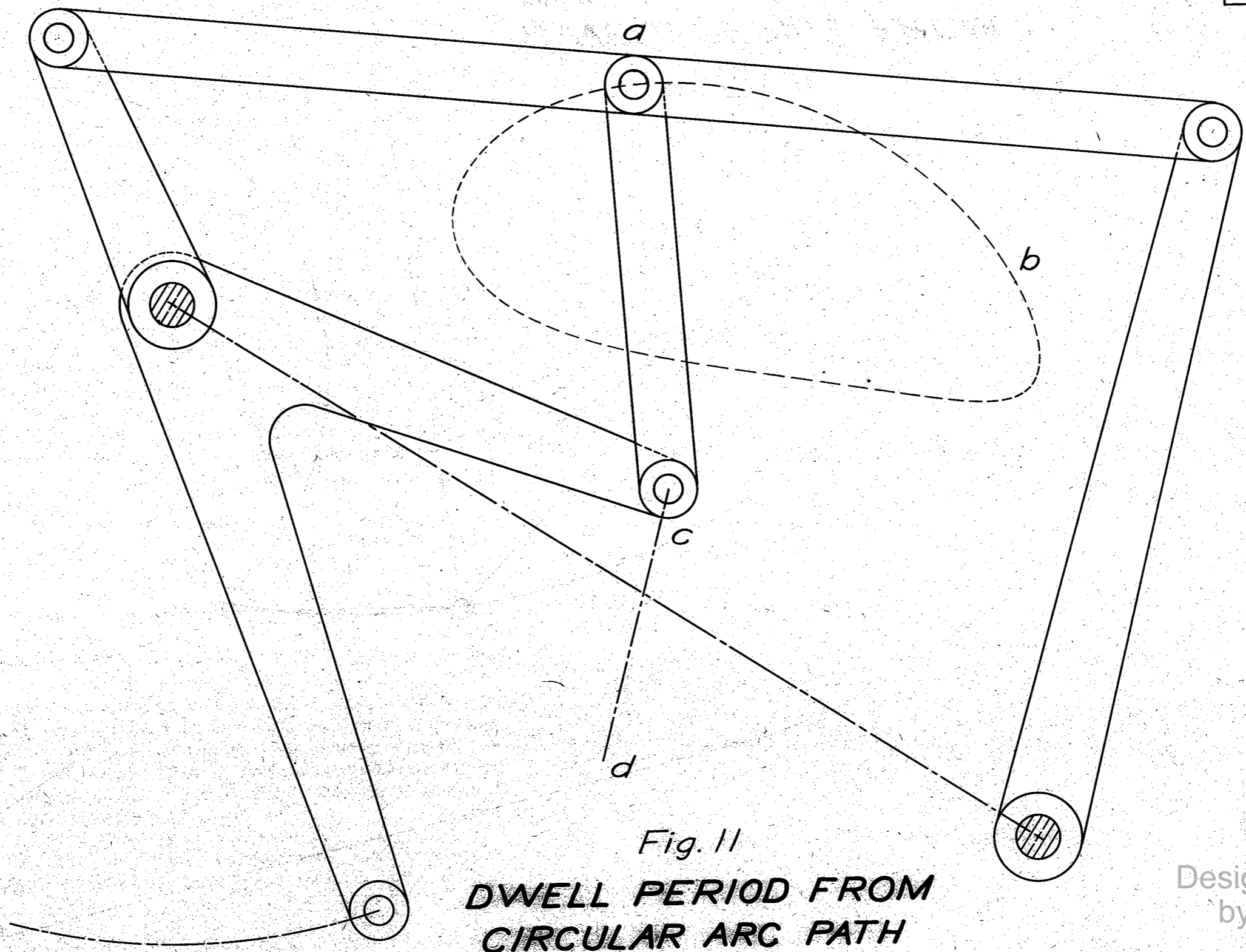
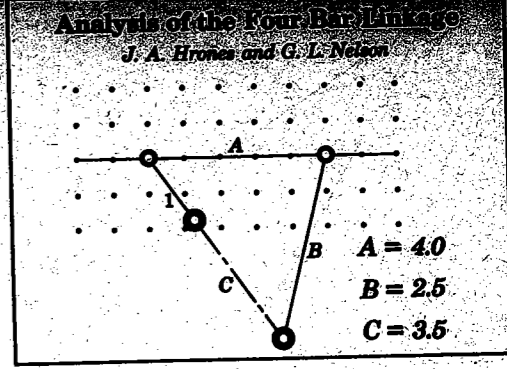

Fig. 11  
**DWELL PERIOD FROM  
 CIRCULAR ARC PATH**

from  
 Design of Machinery 4ed  
 by Robert L. Norton  
 McGraw-Hill  
 Copyright 2008

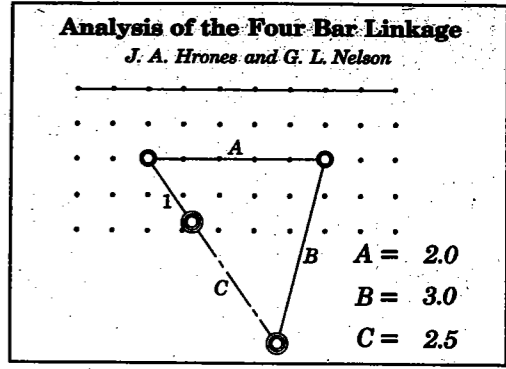
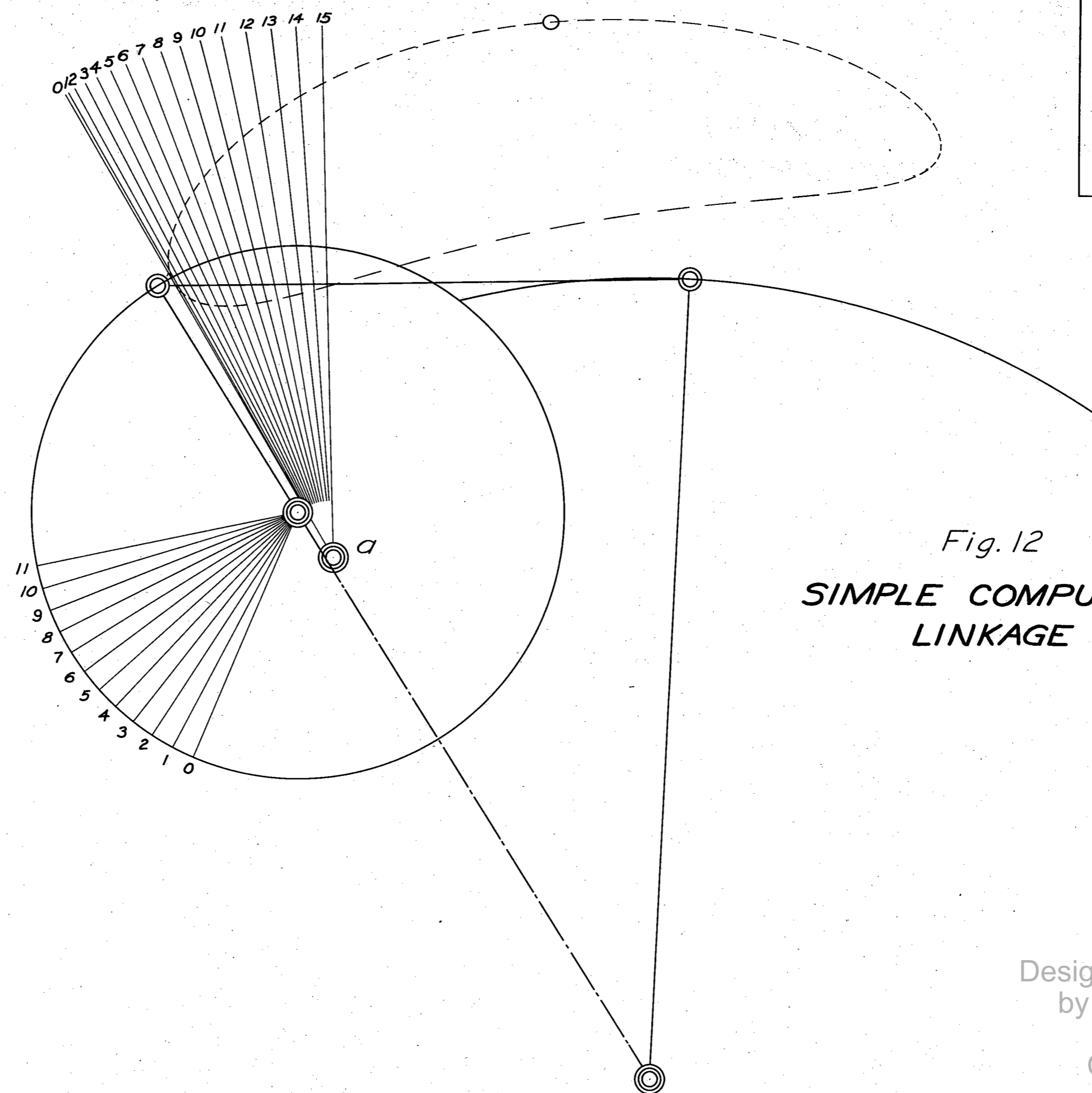

Fig. 12  
**SIMPLE COMPUTER  
 LINKAGE**

from  
 Design of Machinery 4ed  
 by Robert L. Norton  
 McGraw-Hill  
 Copyright 2008

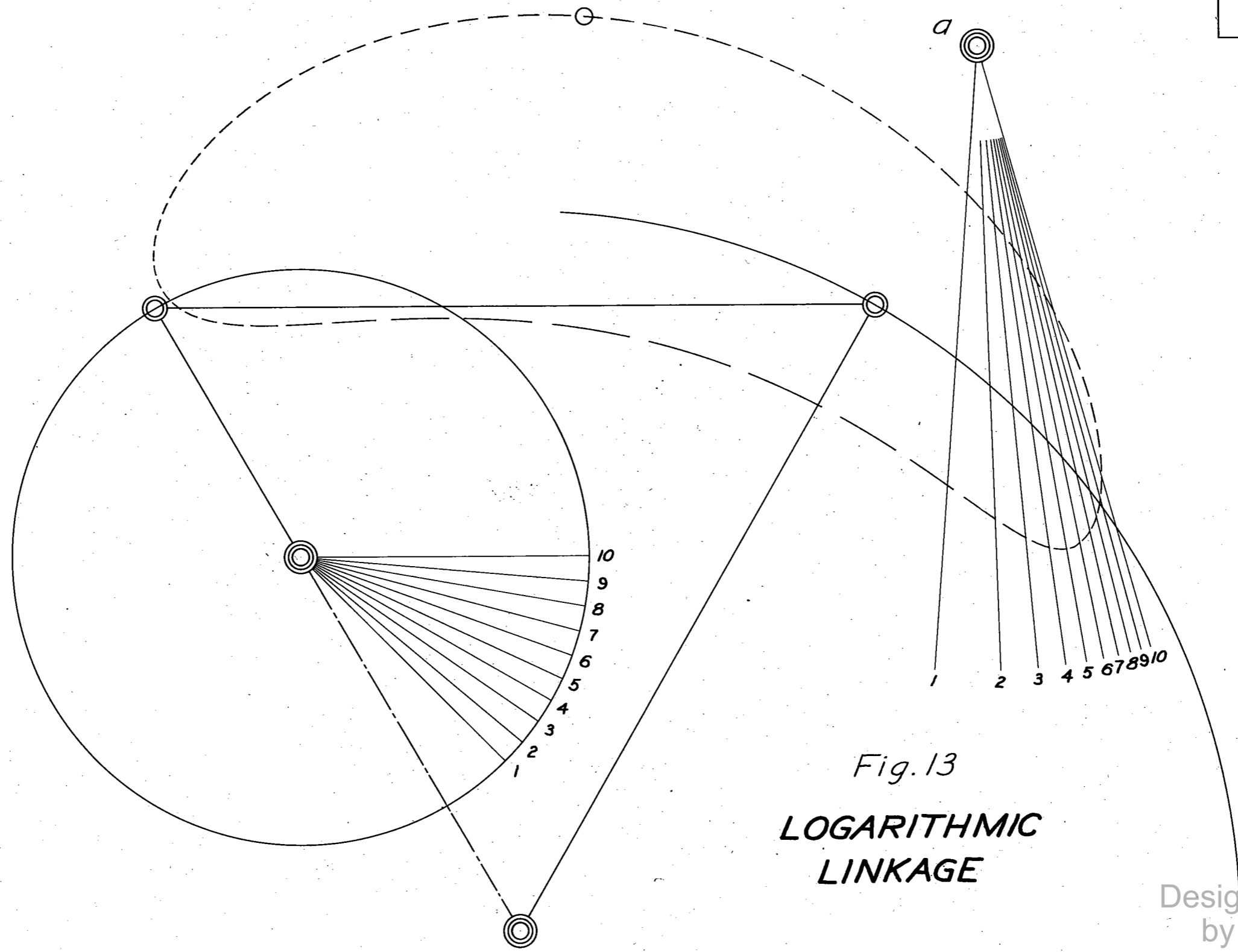
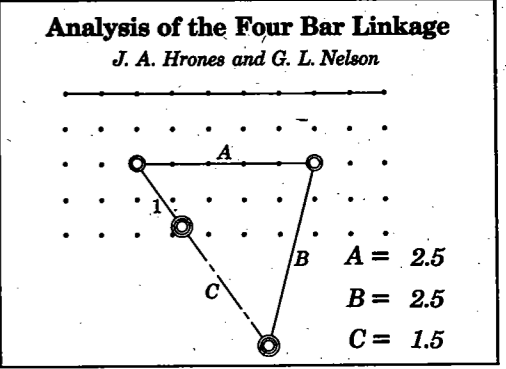
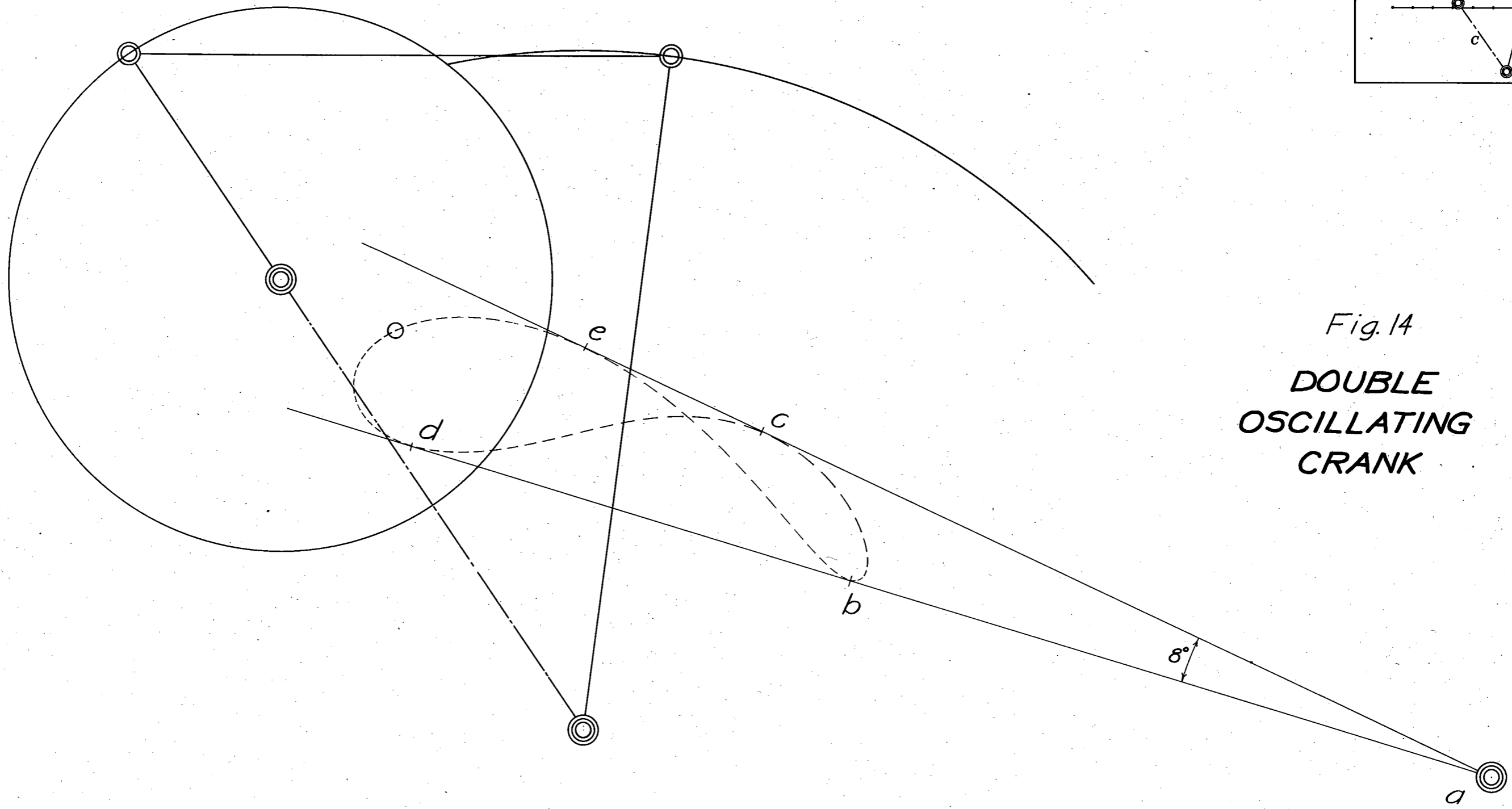
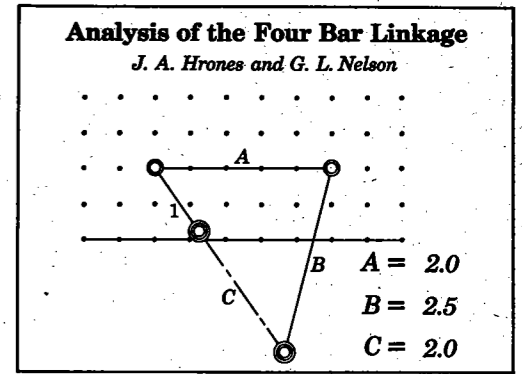

Fig. 13  
**LOGARITHMIC  
LINKAGE**

from  
Design of Machinery 4ed  
by Robert L. Norton  
McGraw-Hill  
Copyright 2008



*Fig. 14*  
**DOUBLE  
 OSCILLATING  
 CRANK**

from  
 Design of Machinery 4ed  
 by Robert L. Norton  
 McGraw-Hill  
 Copyright 2008

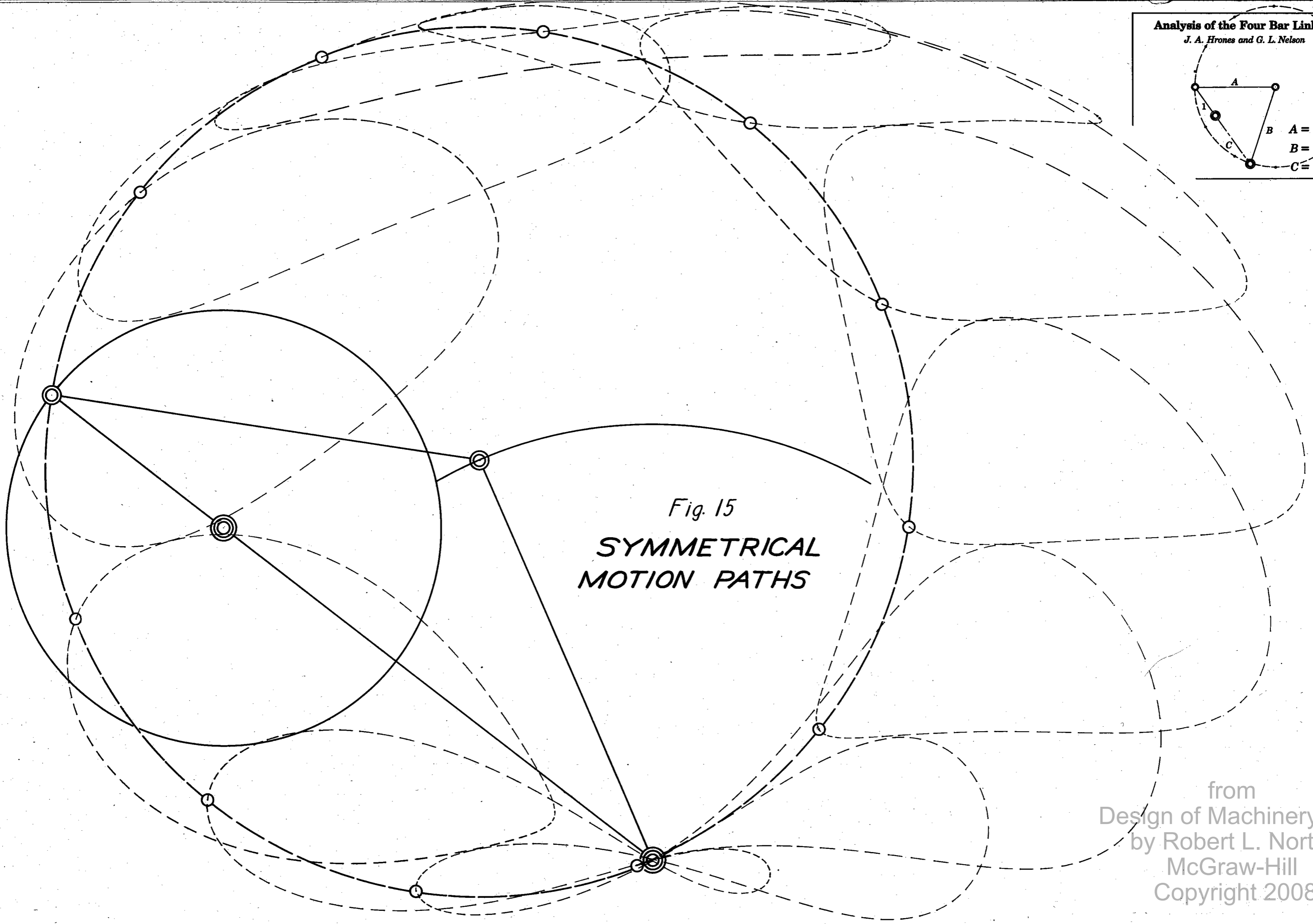
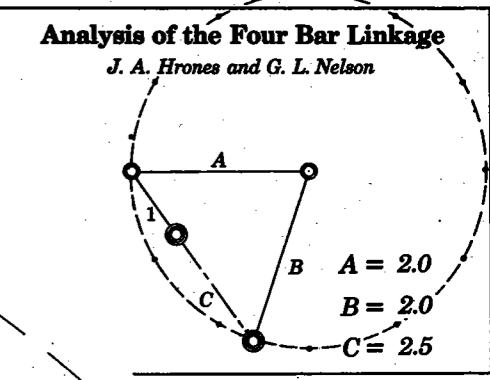

Fig. 15  
**SYMMETRICAL  
MOTION PATHS**

from  
Design of Machinery 4ed  
by Robert L. Norton  
McGraw-Hill  
Copyright 2008

### Cam versus Linkage

The cam is in wide use and in many cases offers a very satisfactory solution. In many instances, however, the cam design limits the performance of the machine. Often, in such circumstances, a suitable linkage removes the cam-imposed difficulties. Because of the difficulty of synthesizing a linkage to achieve a specific motion it is common practice to eliminate the linkage from the design in favor of the cam despite certain limitations. It is hoped that these charts will facilitate the wider use of linkages in such problems.

The cam has certain distinctive advantages. It is very flexible. It can be easily designed to give a wide variety of motions. It can be made small and compact. It is, however, subjected to very high stresses at the points of contact. The cam follower must be constrained to follow the cam contour either by a spring which raises the stress level on the cam or by a grooved slot in which the backlash causes trouble at high speeds of operation. In order to limit the dynamic forces at high speeds to allowable levels the degree of accuracy required in the finishing of the cam contour is beyond the abilities of most shops and in any event results in an extremely expensive operation. The net result is that the top speeds of many machines are set by the limitations of cams. Increasing the speed results in excessive machine vibrations and rapid cam wear. Proper cam design and careful machining can raise such limitations. (See reference 4.)

Linkages very often offer distinct advantages over cams. As the motion is determined by the relative length of the links, small percentage variations in these lengths do not radically influence the resulting motion. Furthermore, the machining operations are simple and can be performed with precision in any shop. Location and machining of the bearings at the link pivots is standard procedure. Link length tolerances of the order of  $\pm 0.002$  inch are easily obtainable and usually adequate. In cam manufacture required tolerances for high-speed operation are of the order of  $\pm 0.0002$  inch. In addition the stress levels at the pivots of a linkage are more favorable than they are at the cam surface.

### Balancing of Linkages

If a linkage is to be operated at significant speeds careful attention must be paid to the dynamic forces produced. It is important to keep the mass of the moving links as small as possible. Aluminum or magnesium alloys with a low-weight high-stiffness cross-section design result in link members with low inertia forces. To prevent the transmission of large oscillating forces to the linkage supports, inertia forces should be balanced. The subject of balancing linkages is covered in reference 1.

### Use of Models in Design Work

The charts give motion characteristics of many linkages and therefore lead directly to the selection of the basic link ratios. It is advisable to con-

struct a simple scale model of cardboard or aluminum sheet stock to check the linkage for bad angularity between links, excessive torque ratio, and possible interferences.

### Velocity Determination

Consider the trajectory shown in figure 16. The point moving along the trajectory traverses a distance  $ab$  measured along the path in an interval required for the drive crank to move through  $5^\circ$ . If the drive crank is rotating at a uniform angular speed the average velocity of the point during this travel is the length  $ab$  divided by the time the drive crank requires to move through  $5^\circ$ .

$$(V_{ab}) = \frac{(ab)\omega}{5}$$

where  $V_{ab}$  = average velocity of point moving along trajectory from point  $a$  to point  $b$  (inches per second).

$ab$  = length between  $a$  and  $b$  measured along trajectory (inches).

$\omega$  = angular speed of drive crank (degrees per second).

### Acceleration Determination

The acceleration of a point moving in space is defined by the following relationships.

$$V = \lim_{\Delta t \rightarrow 0} \left( \frac{\Delta s}{\Delta t} \right) = \frac{ds}{dt}$$

$$\text{acc.} = \frac{dV}{dt} = \lim_{\Delta t \rightarrow 0} \left( \frac{\Delta V}{\Delta t} \right)$$

$$\left( \frac{\Delta V}{\Delta t} \right)_b = \frac{V_{bc} - V_{ab}}{\Delta t} = \frac{(bc - ab)\omega^2}{25}$$

Thus, an approximation of the acceleration at  $b$  is found by evaluating the vector difference  $(bc - ab)$  and multiplying by the factor  $(\omega^2/25)$ .

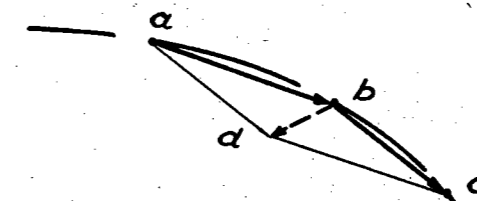

Fig. 16

from  
Design of Machinery 4ed  
by Robert L. Norton  
McGraw-Hill  
Copyright 2008

As the acceleration is determined by subtraction, where the acceleration is small the vectors  $bc$  and  $ab$  are nearly equal and very large errors in acceleration determination can be encountered. However, at points on the trajectory where the acceleration is high the percentage error will be relatively low. In general, errors in acceleration determination will vary from as low as 10 per cent to as high as 100 per cent or greater. Where the error tends to be excessive, owing to the subtraction of two nearly equal velocity vectors, the use of average velocity vectors over a greater drive crank angle is helpful. Thus, instead of using average velocity vectors for a  $5^\circ$  crank increment, values for a  $15^\circ$  increment might be desirable.

#### Accuracy of Trajectories

Link lengths of the machine used in producing the trajectories were held to a tolerance of  $\pm 0.005$  inch. For a given machine setup, operation of the machine over several cycles produced identical results as far as detectable by the naked eye. The trajectory at any point is accurate to  $\pm 0.01$  inch. The possibilities of greater errors in the dash lengths exist resulting from a possible accumulation of machining errors on the timing cam, variable time lag in the pen operating mechanism, etc. The indications are that the errors in dash-space length rarely exceed 5 per cent and usually are very much smaller.

The length of the drive crank of the machine was 5.00 inches, and tolerances indicated above are referred to this basic size. The reproductions are one-half the scale of the originals. For clockwise rotation of the drive crank the point moves along the trajectory in a direction proceeding from the dot to the tail of the dash.

#### LIST OF REFERENCES

- (1) Talbourdet, Guy J., "Mathematical Solution of Four-Bar Linkages;" *Machine Design*; May, June and July, 1941.
- (2) Nelson, George L., "Synthesis of Four-Bar Linkages for the Reproduction of Desired Motion Paths;" Master of Science Thesis, Dept. of Mechanical Engineering, Massachusetts Institute of Technology; June, 1949.
- (3) Svoboda, Antonin, *Computing Mechanisms and Linkages*; edited by Hubert M. James, McGraw-Hill; 1948.
- (4) Hrones, John A., "Key Factors in Cam Design and Application;" *Machine Design*; April, May and June, 1949, and "An Analysis of the Dynamic Forces in a Cam-Driven System;" *Transactions of the American Society of Mechanical Engineers*, Vol. 70, 1948.

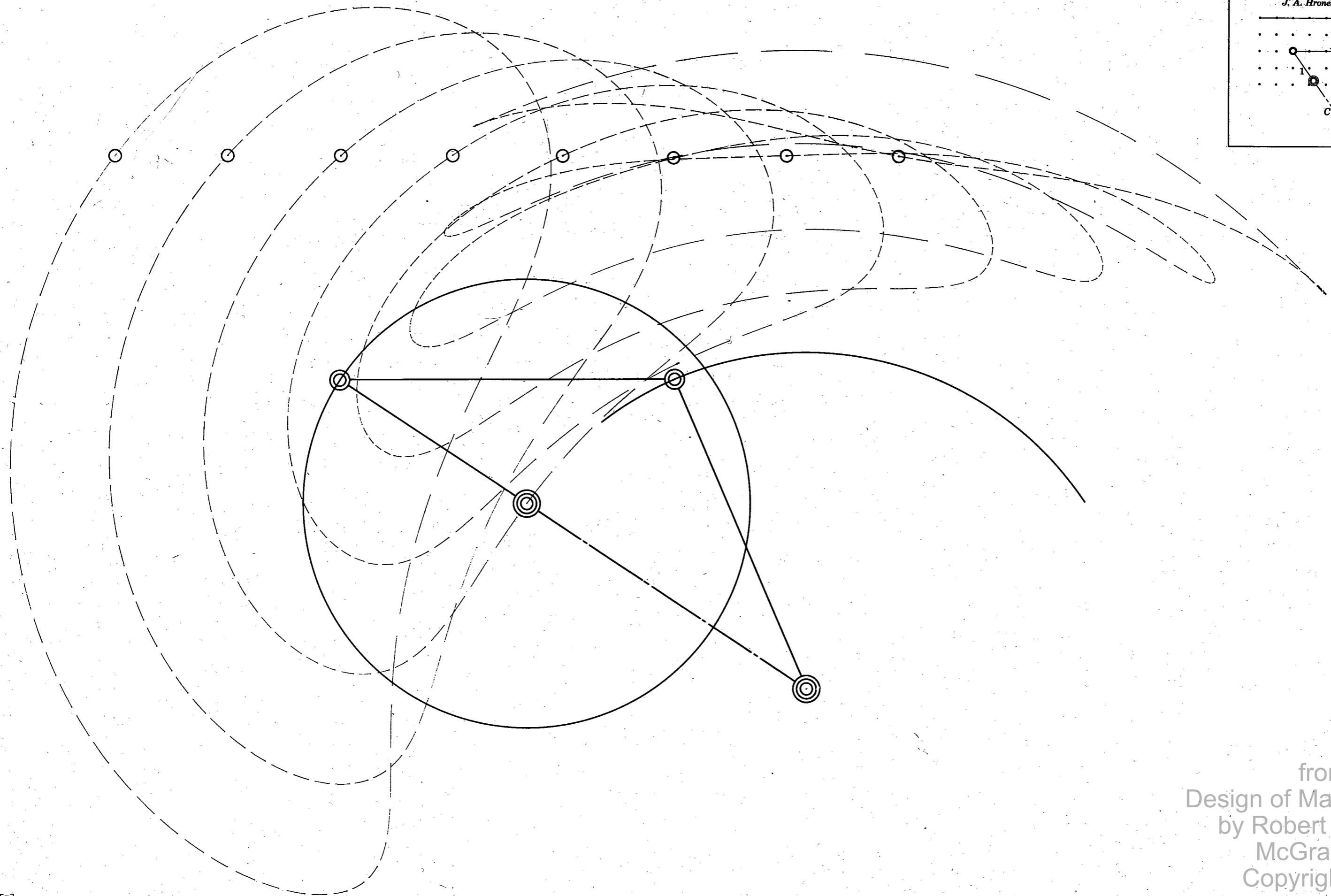
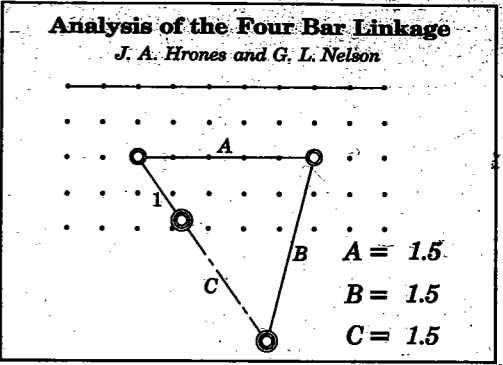

from  
 Design of Machinery 4ed  
 by Robert L. Norton  
 McGraw-Hill  
 Copyright 2008



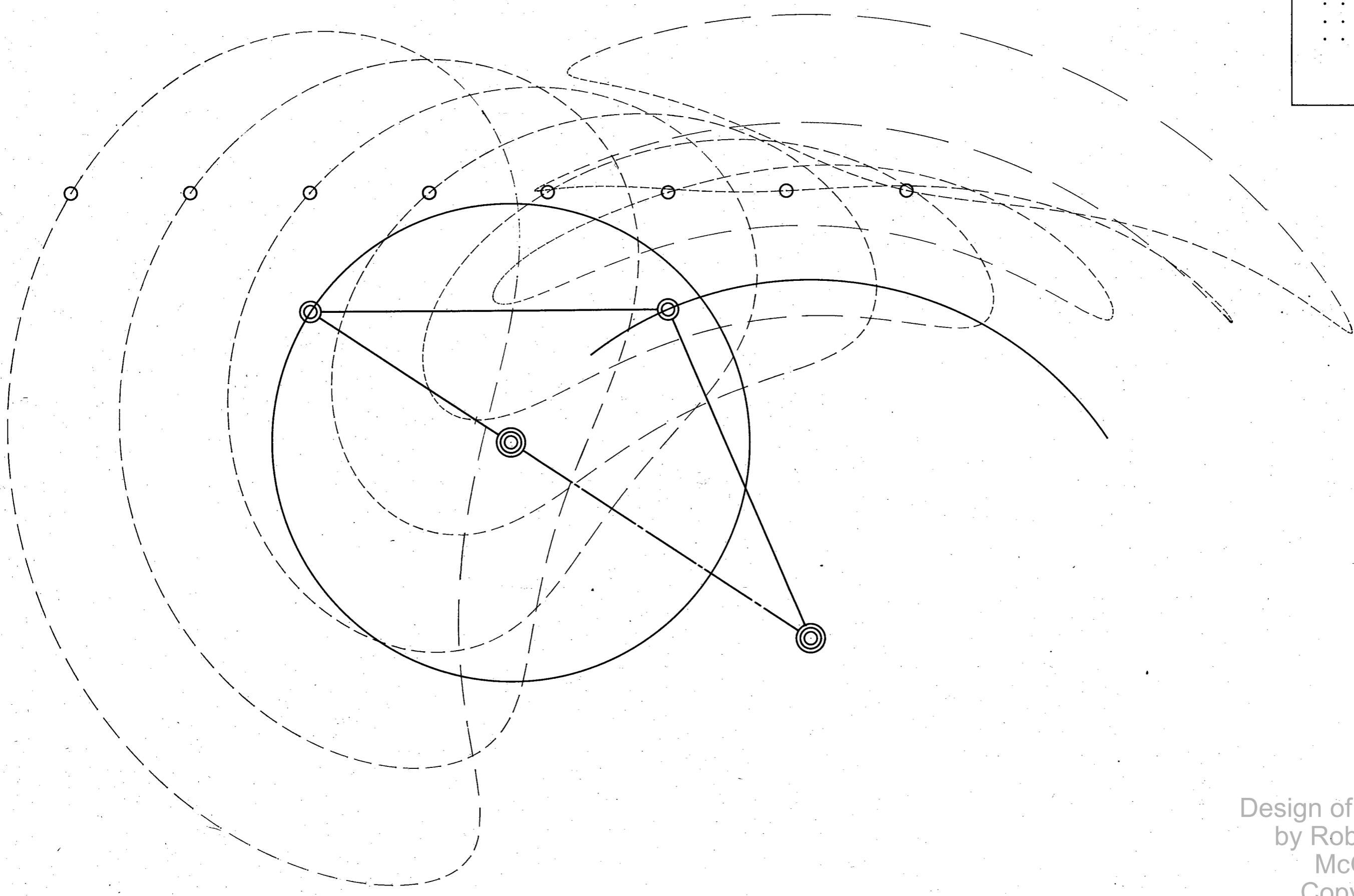
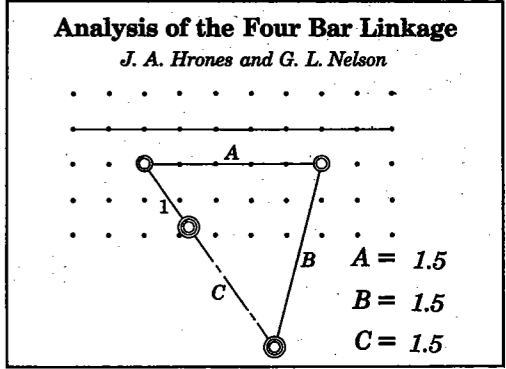

from  
Design of Machinery 4ed  
by Robert L. Norton  
McGraw-Hill  
Copyright 2008

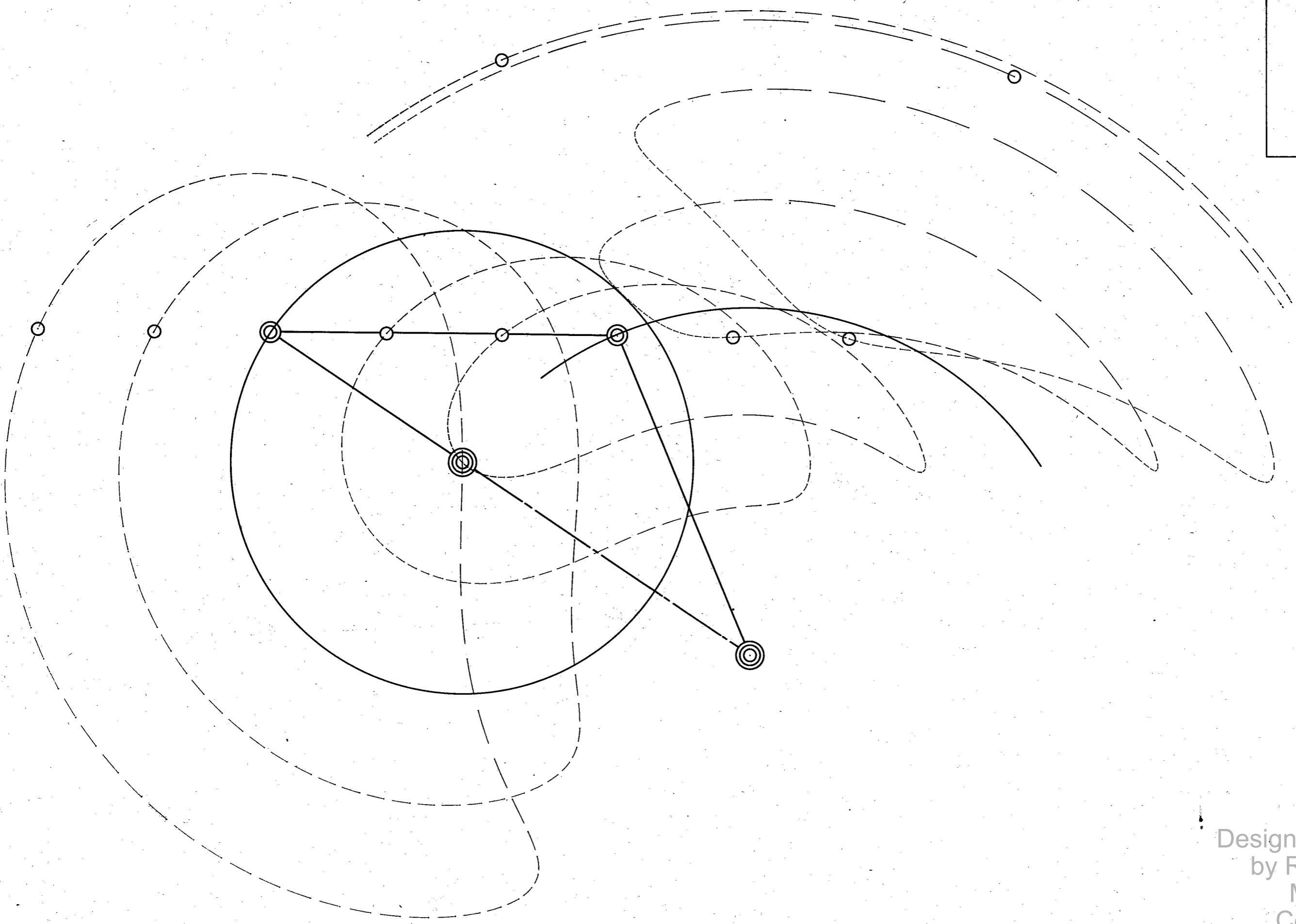
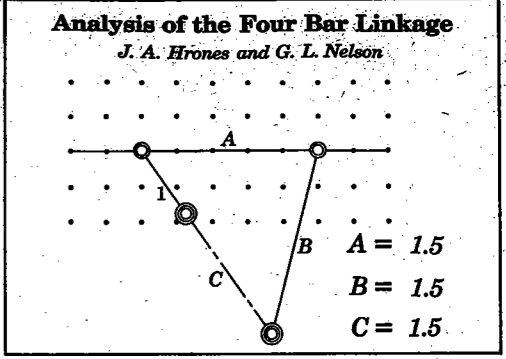

from  
 Design of Machinery 4ed  
 by Robert L. Norton  
 McGraw-Hill  
 Copyright 2008

**Analysis of the Four Bar Linkage**

*J. A. Hrones and G. L. Nelson*

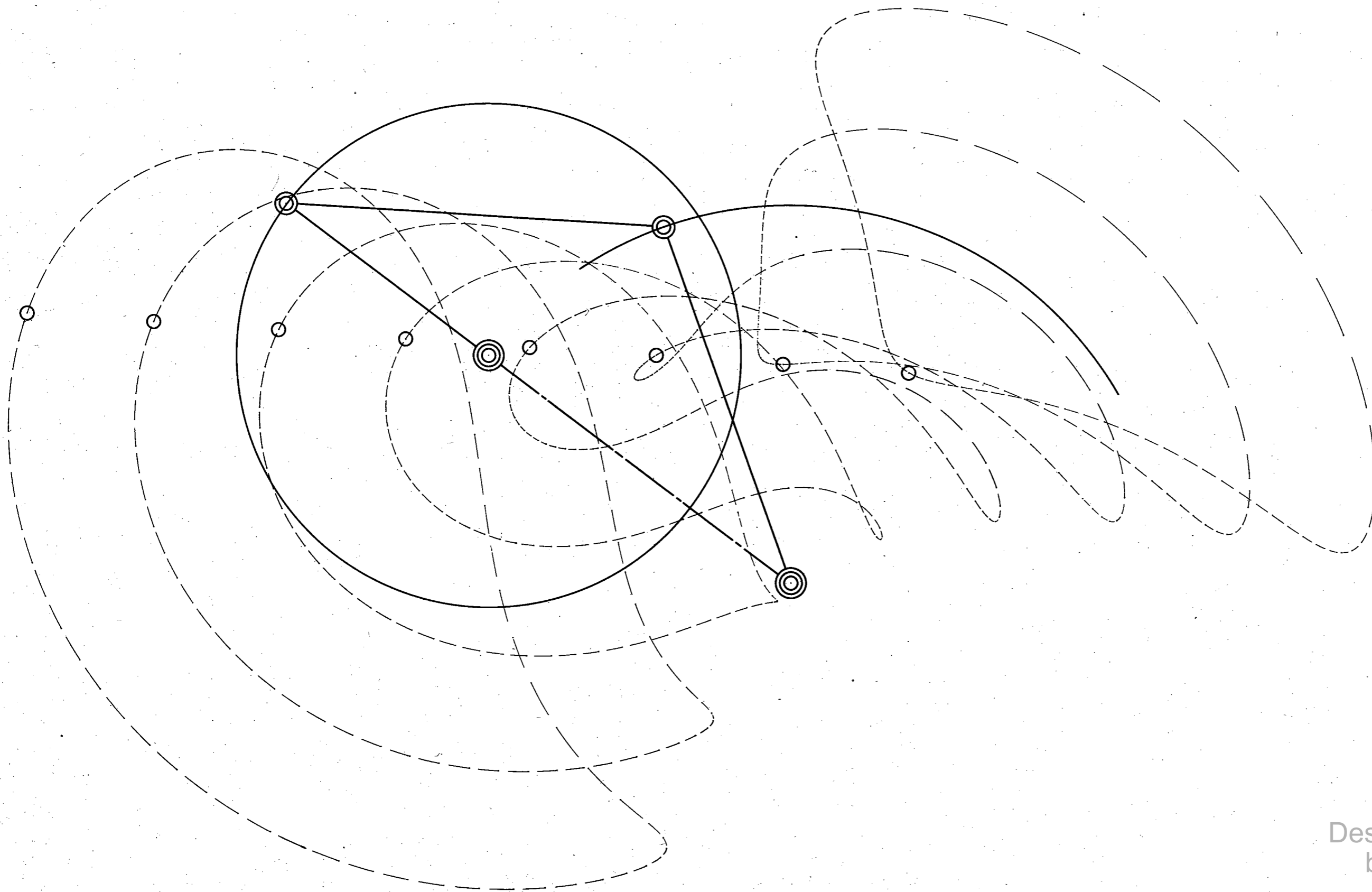
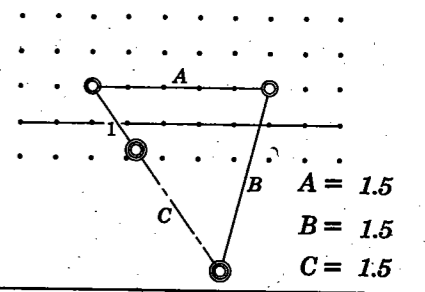

from  
Design of Machinery 4ed  
by Robert L. Norton  
McGraw-Hill  
Copyright 2008

**Analysis of the Four Bar Linkage**

*J. A. Hrones and G. L. Nelson*

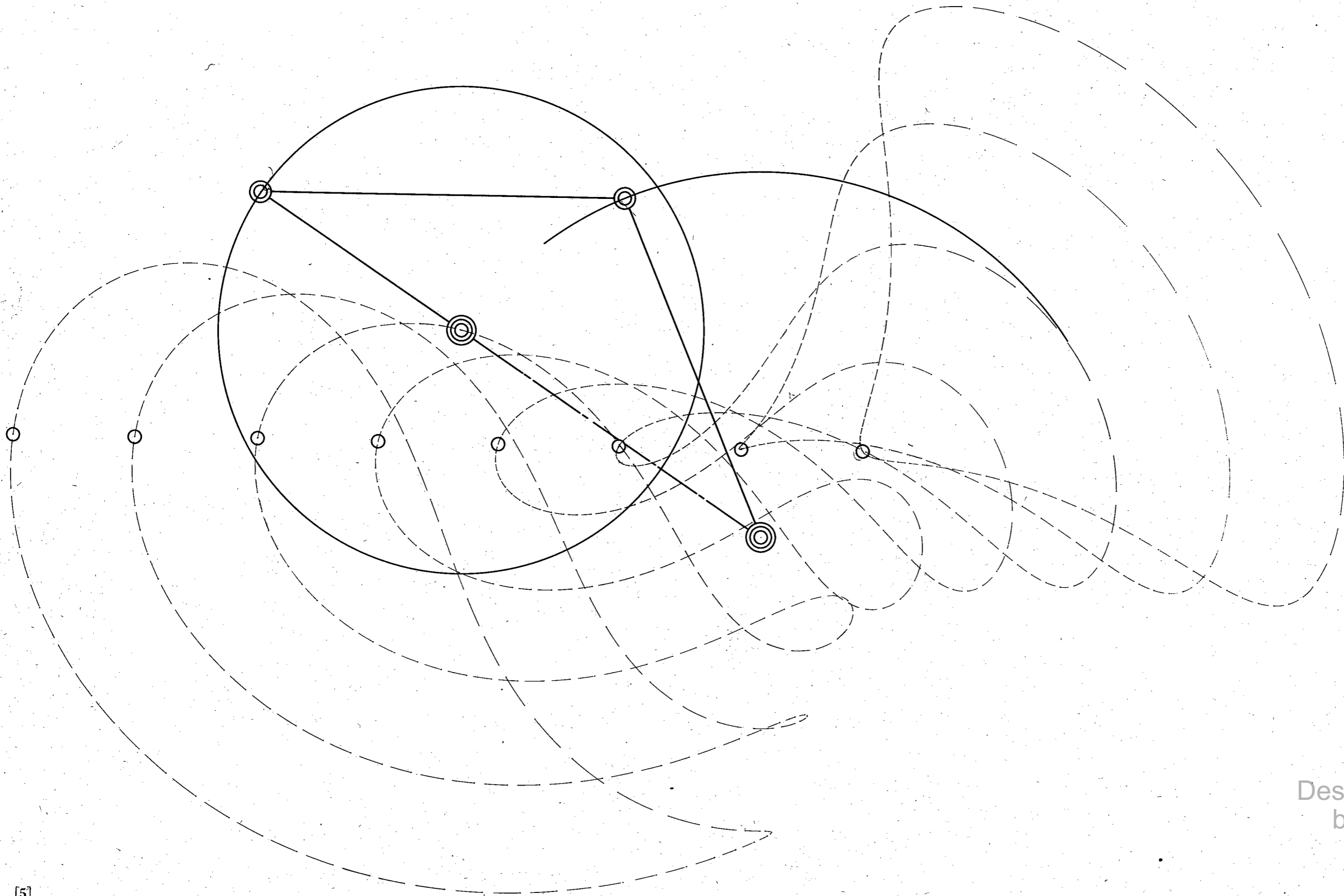
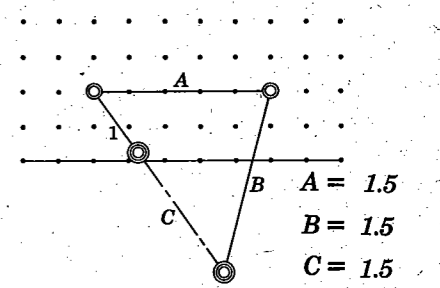

from  
Design of Machinery 4ed  
by Robert L. Norton  
McGraw-Hill  
Copyright 2008

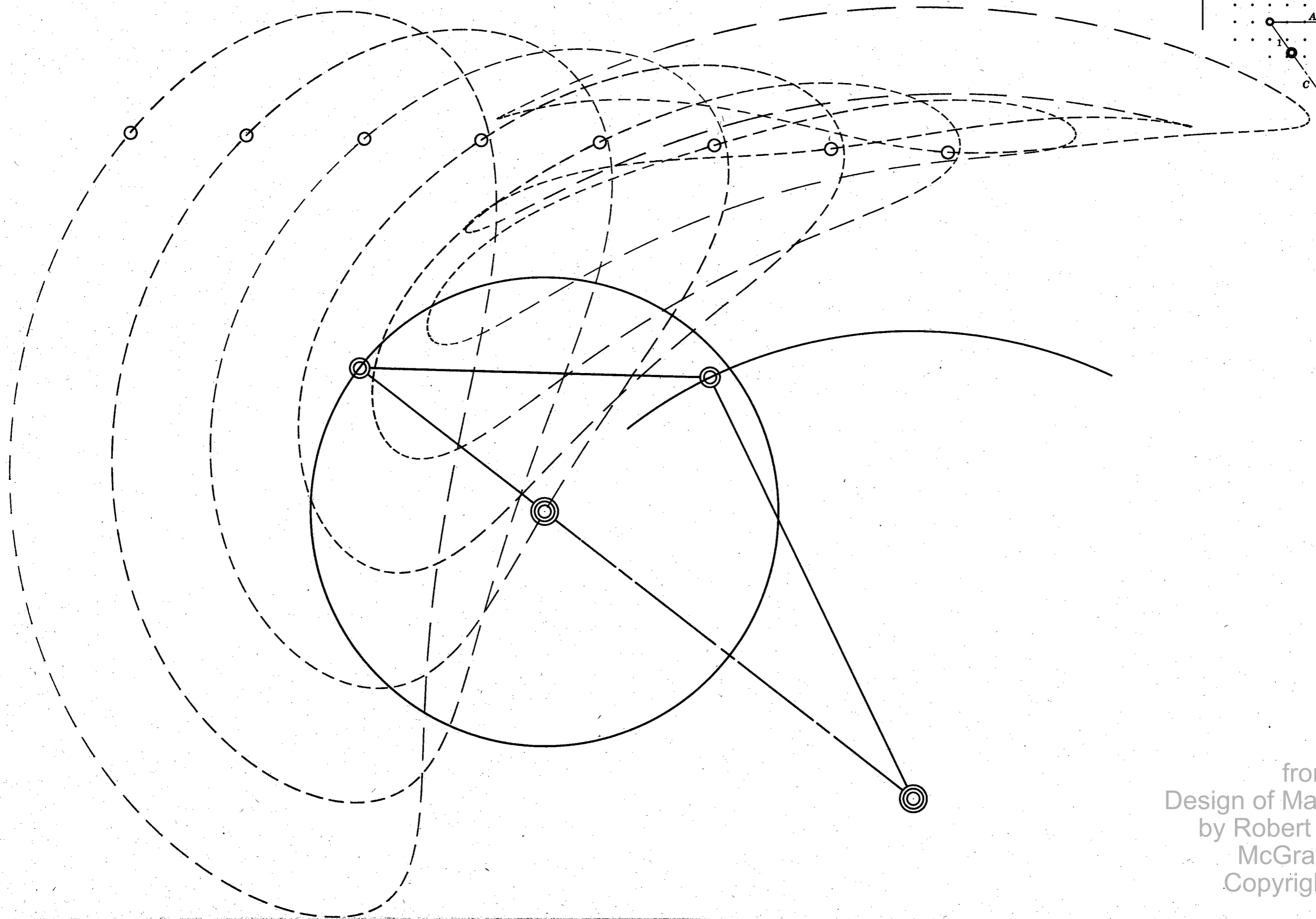
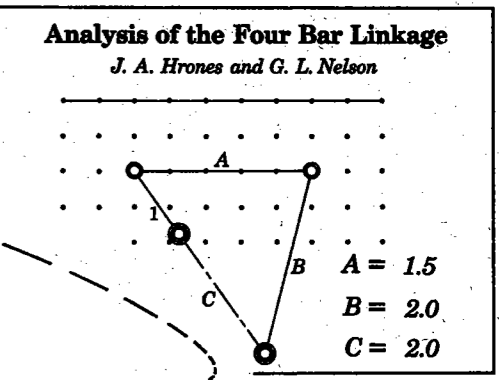

from  
Design of Machinery 4ed  
by Robert L. Norton  
McGraw-Hill  
Copyright 2008

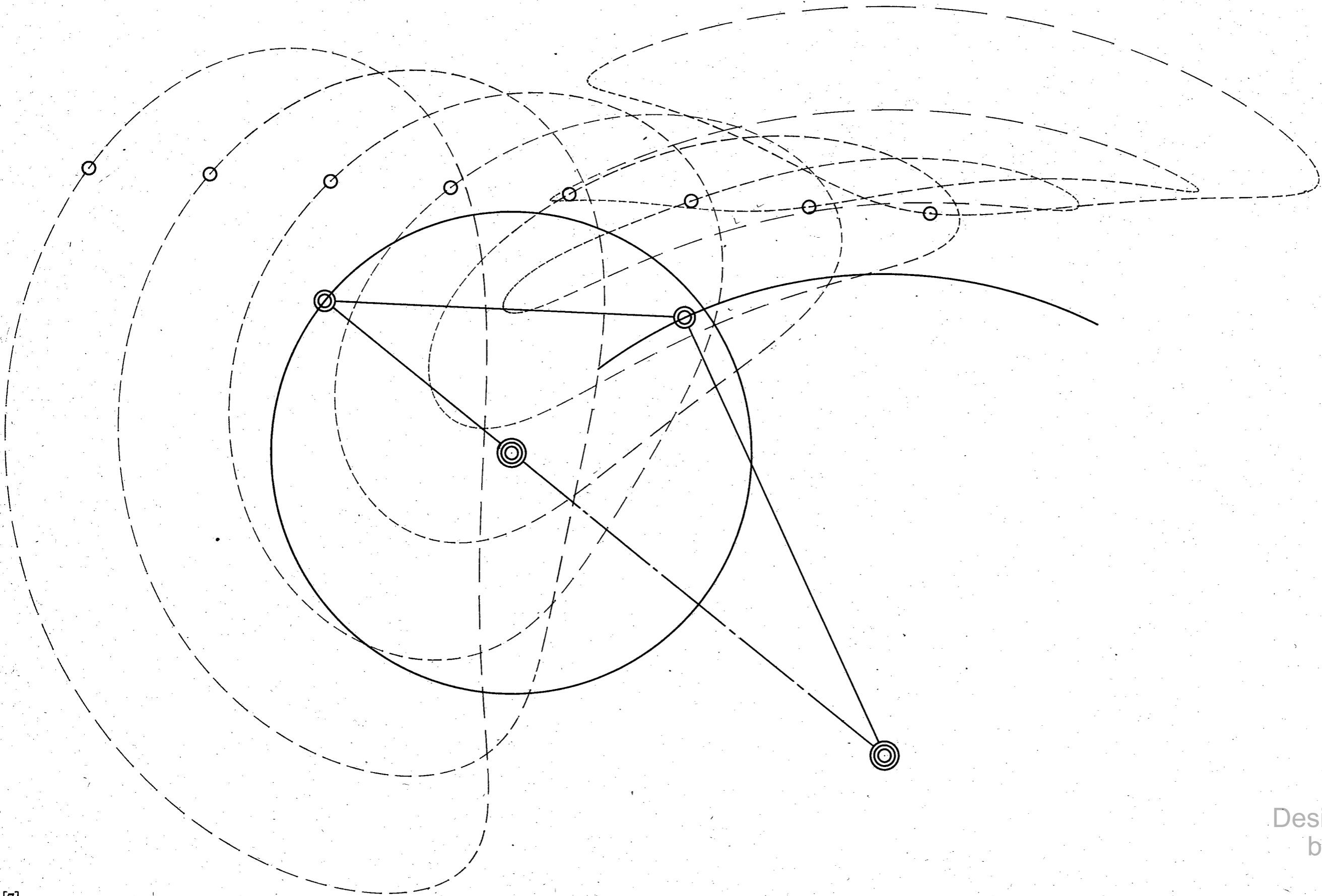
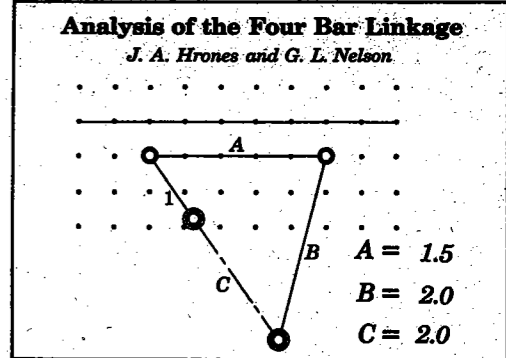

from  
 Design of Machinery 4ed  
 by Robert L. Norton  
 McGraw-Hill  
 Copyright 2008

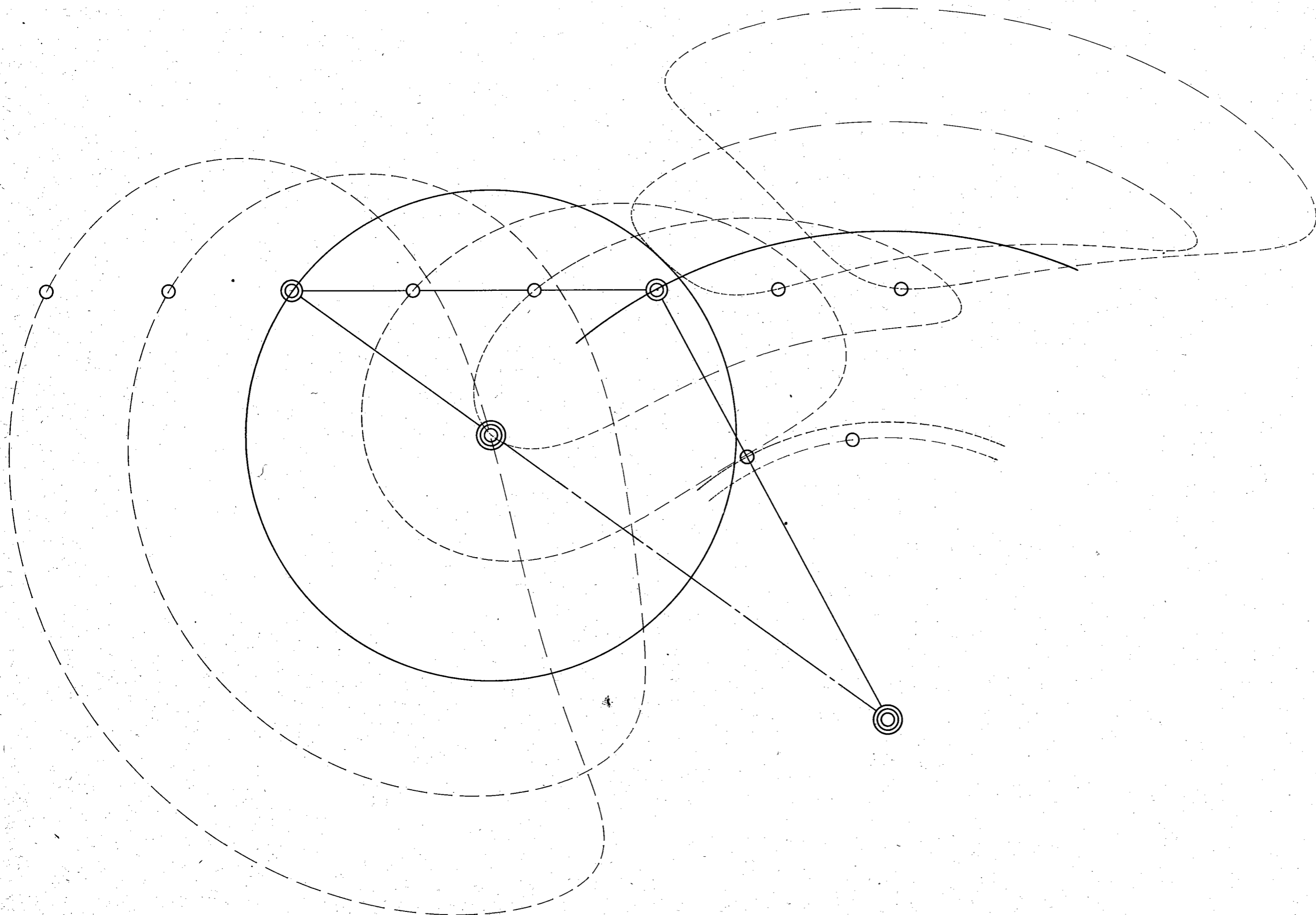
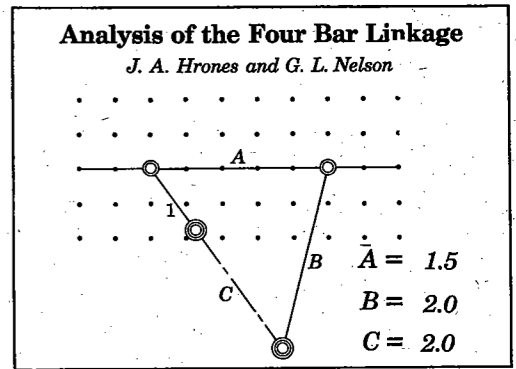

from  
Design of Machinery 4ed  
by Robert L. Norton  
McGraw-Hill  
Copyright 2008

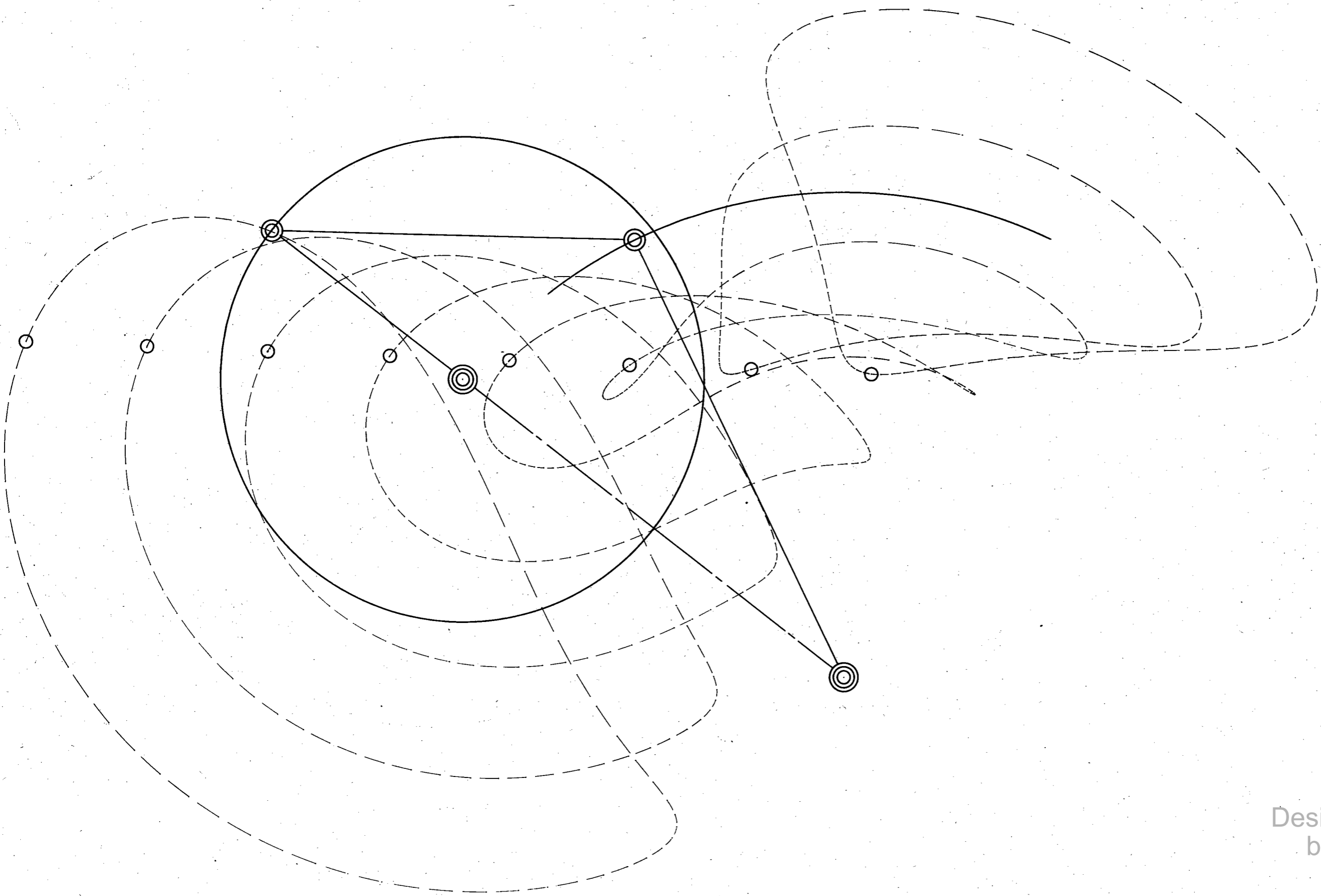
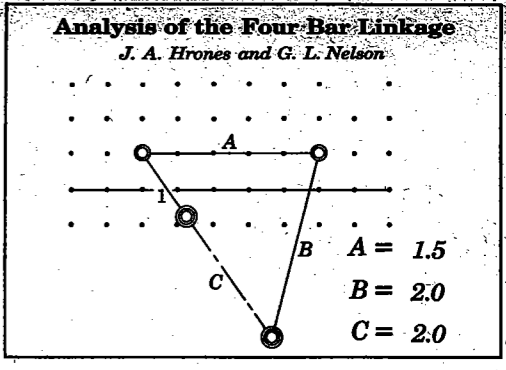

from  
 Design of Machinery 4ed  
 by Robert L. Norton  
 McGraw-Hill  
 Copyright 2008



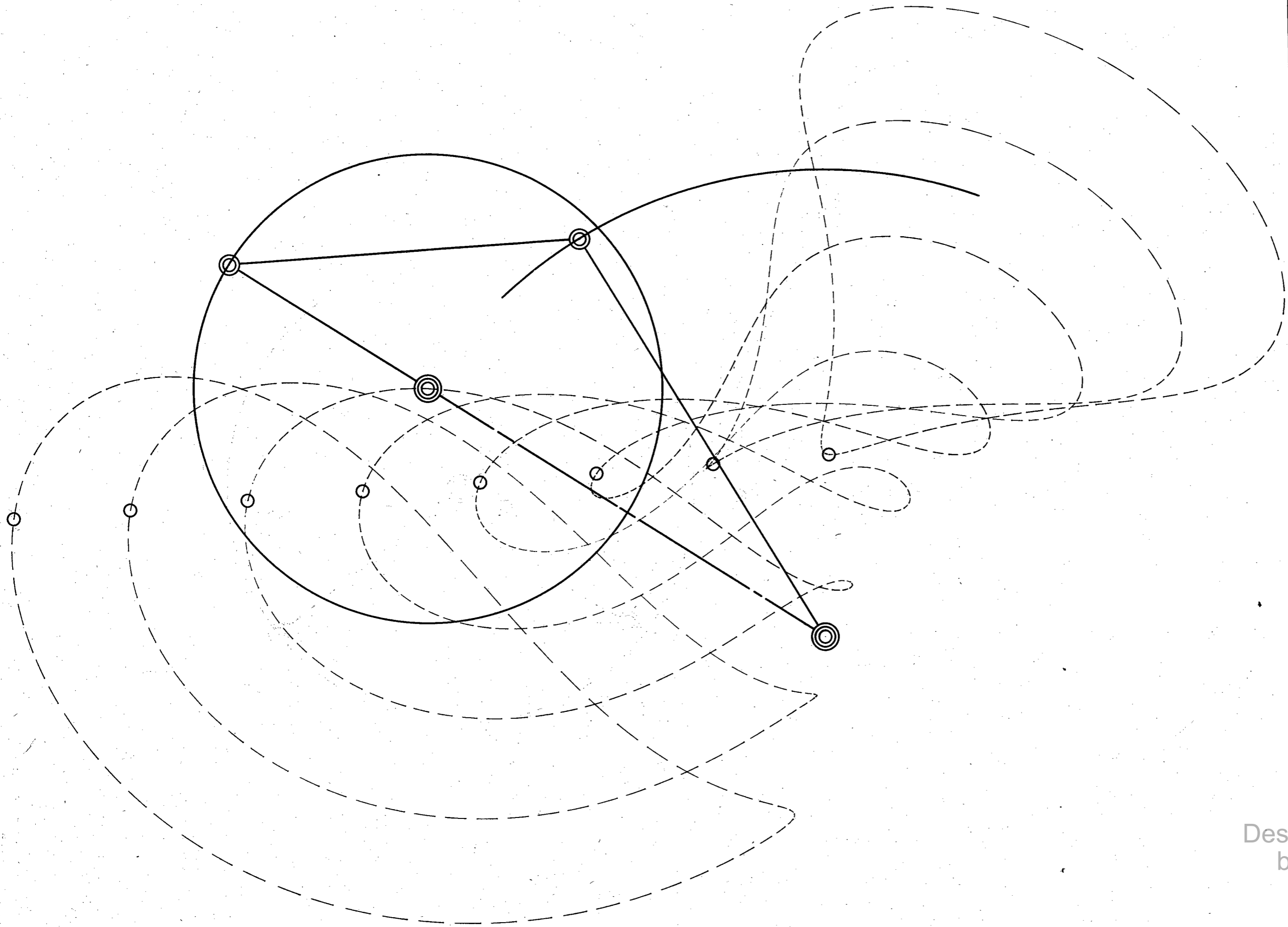
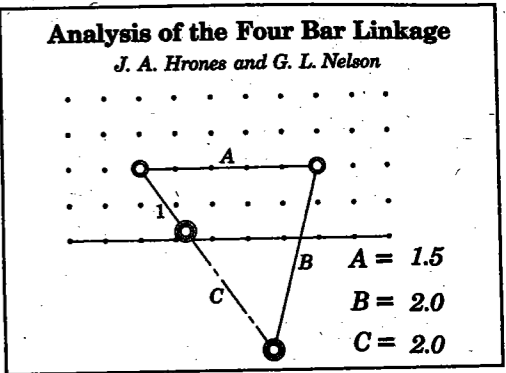

from  
Design of Machinery 4ed  
by Robert L. Norton  
McGraw-Hill  
Copyright 2008

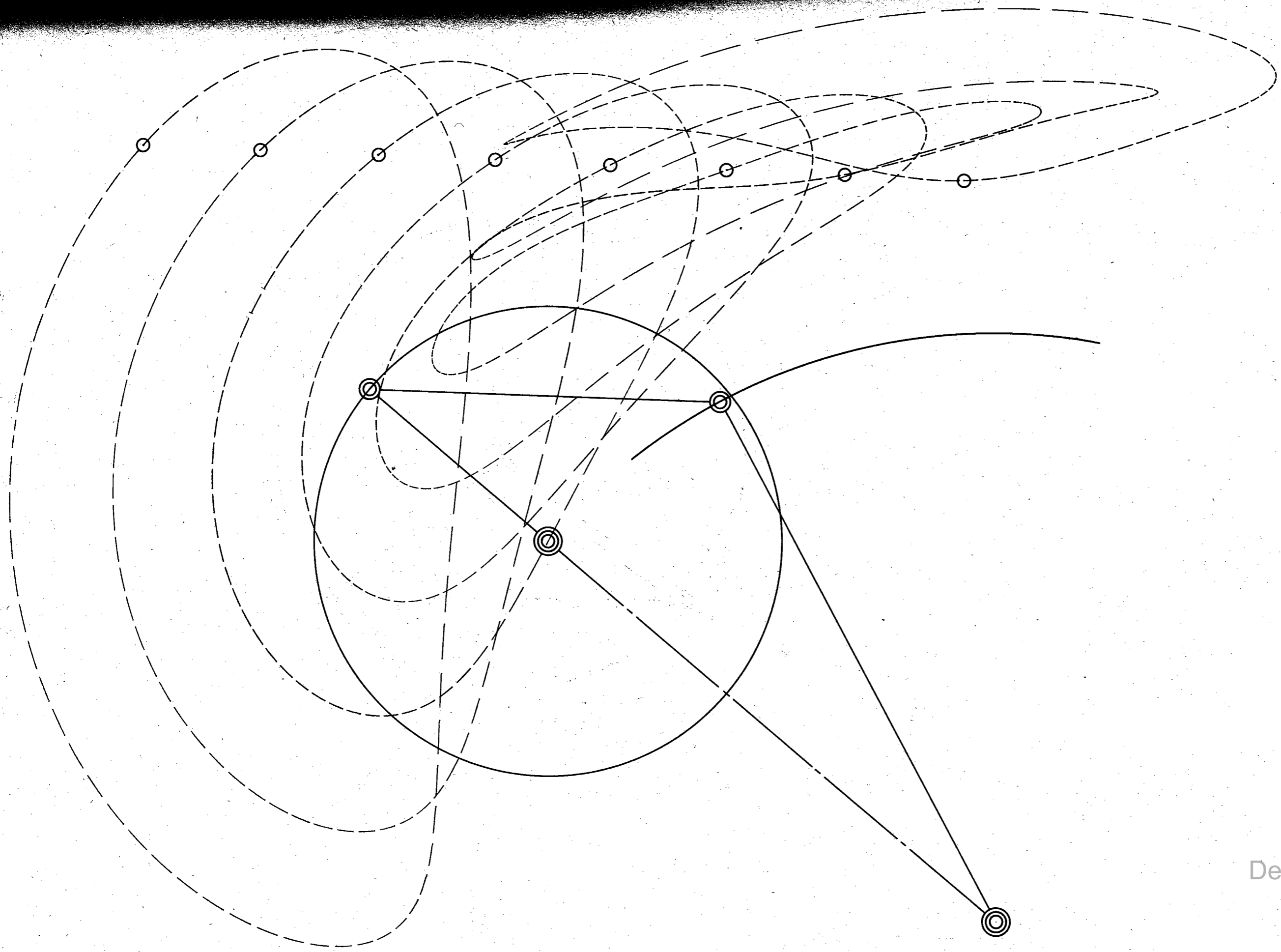
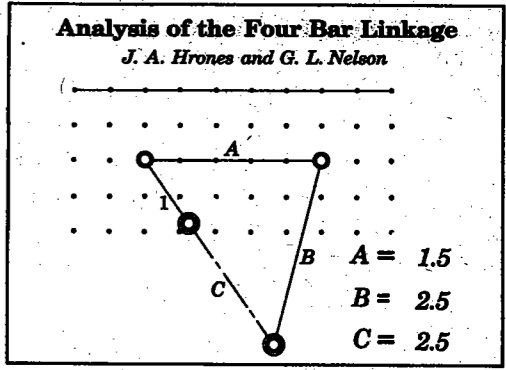

from  
 Design of Machinery 4ed  
 by Robert L. Norton  
 McGraw-Hill  
 Copyright 2008

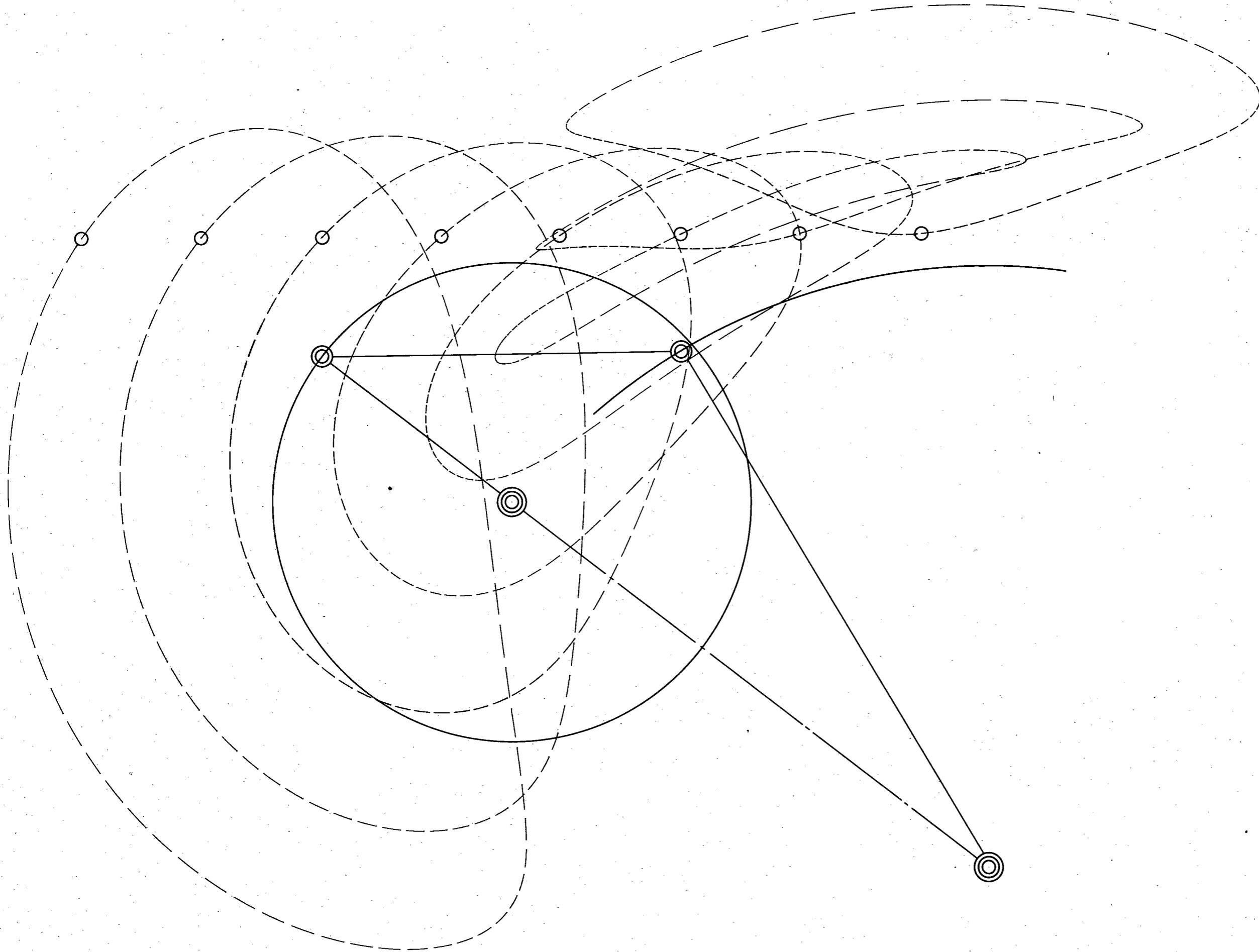
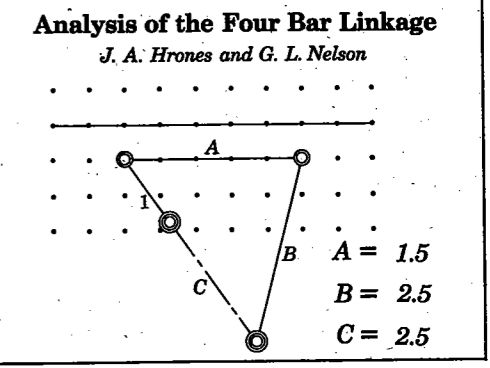

from  
Design of Machinery 4ed  
by Robert L. Norton  
McGraw-Hill  
Copyright 2008

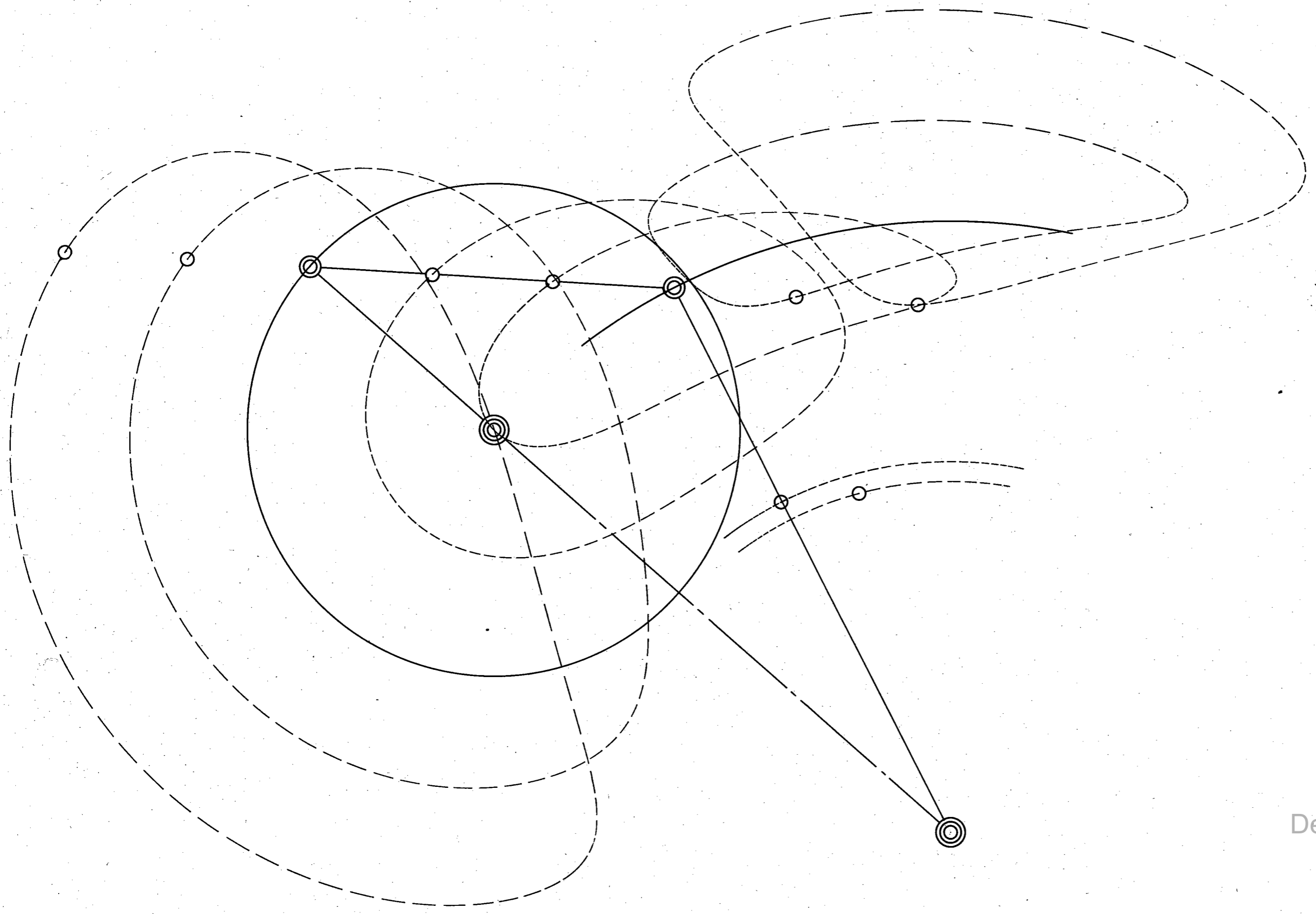
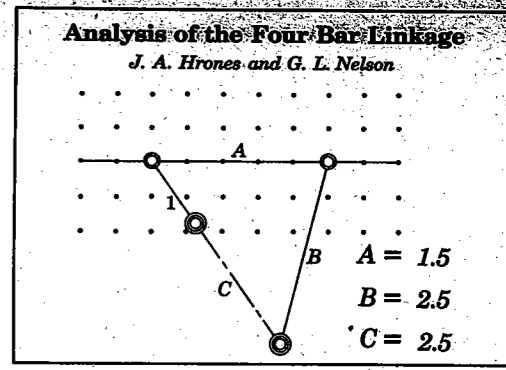

from  
 Design of Machinery 4ed  
 by Robert L. Norton  
 McGraw-Hill  
 Copyright 2008

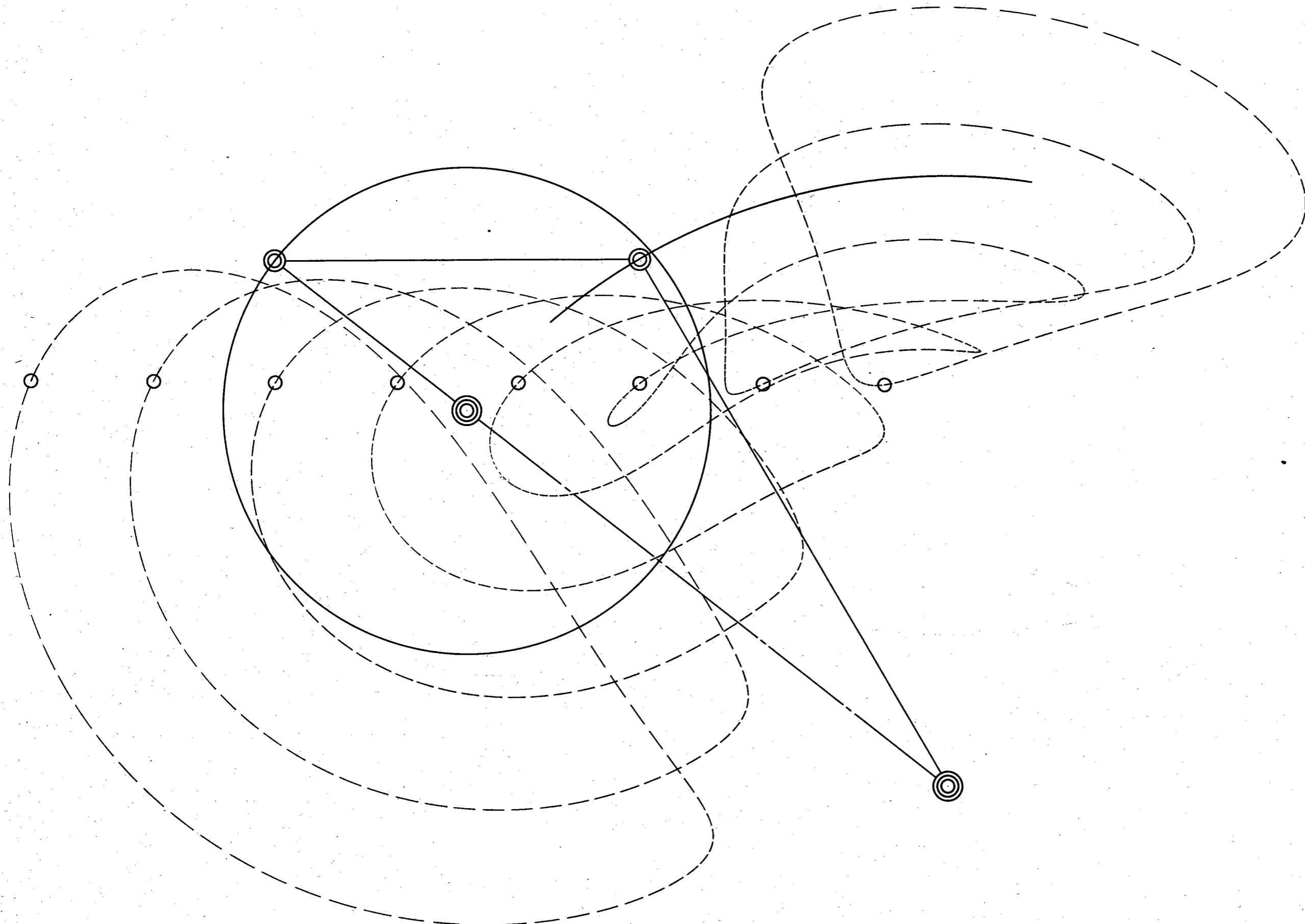
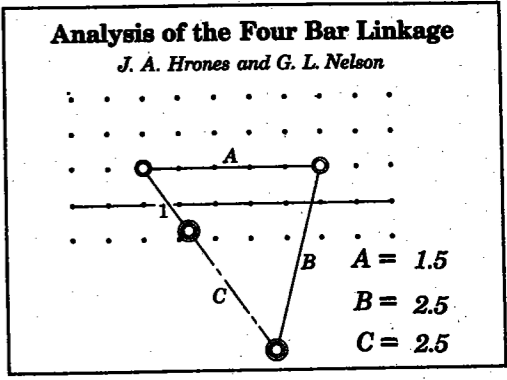

from  
Design of Machinery 4ed.  
by Robert L. Norton  
McGraw-Hill  
Copyright 2008

**Analysis of the Four Bar Linkage**

*J. A. Hrones and G. L. Nelson*

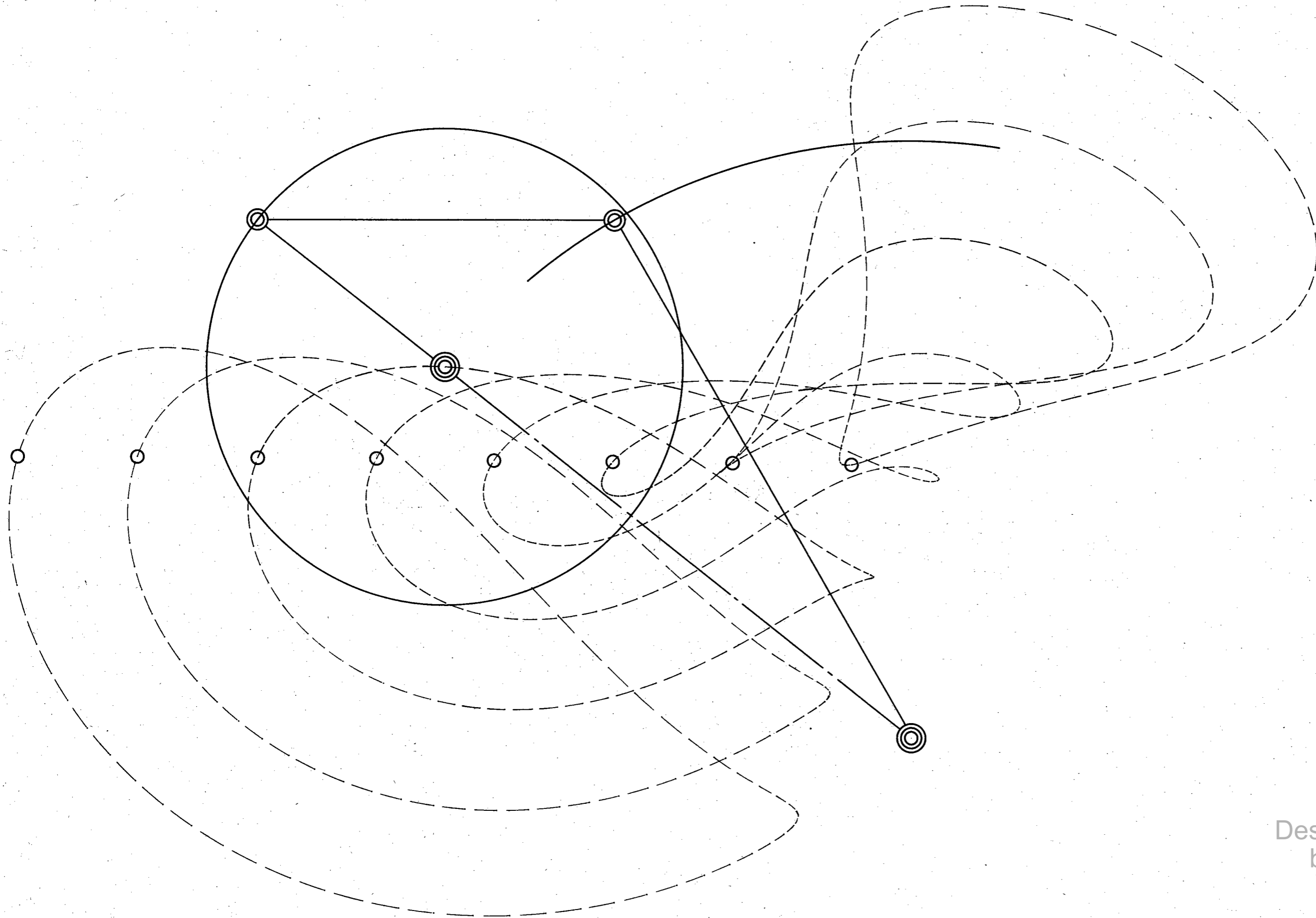
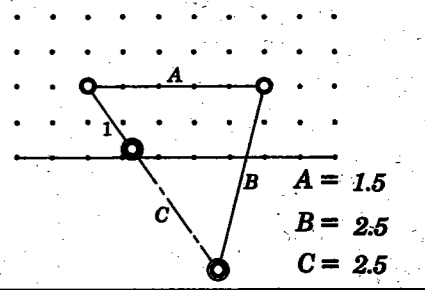

from  
Design of Machinery 4ed  
by Robert L. Norton  
McGraw-Hill  
Copyright 2008

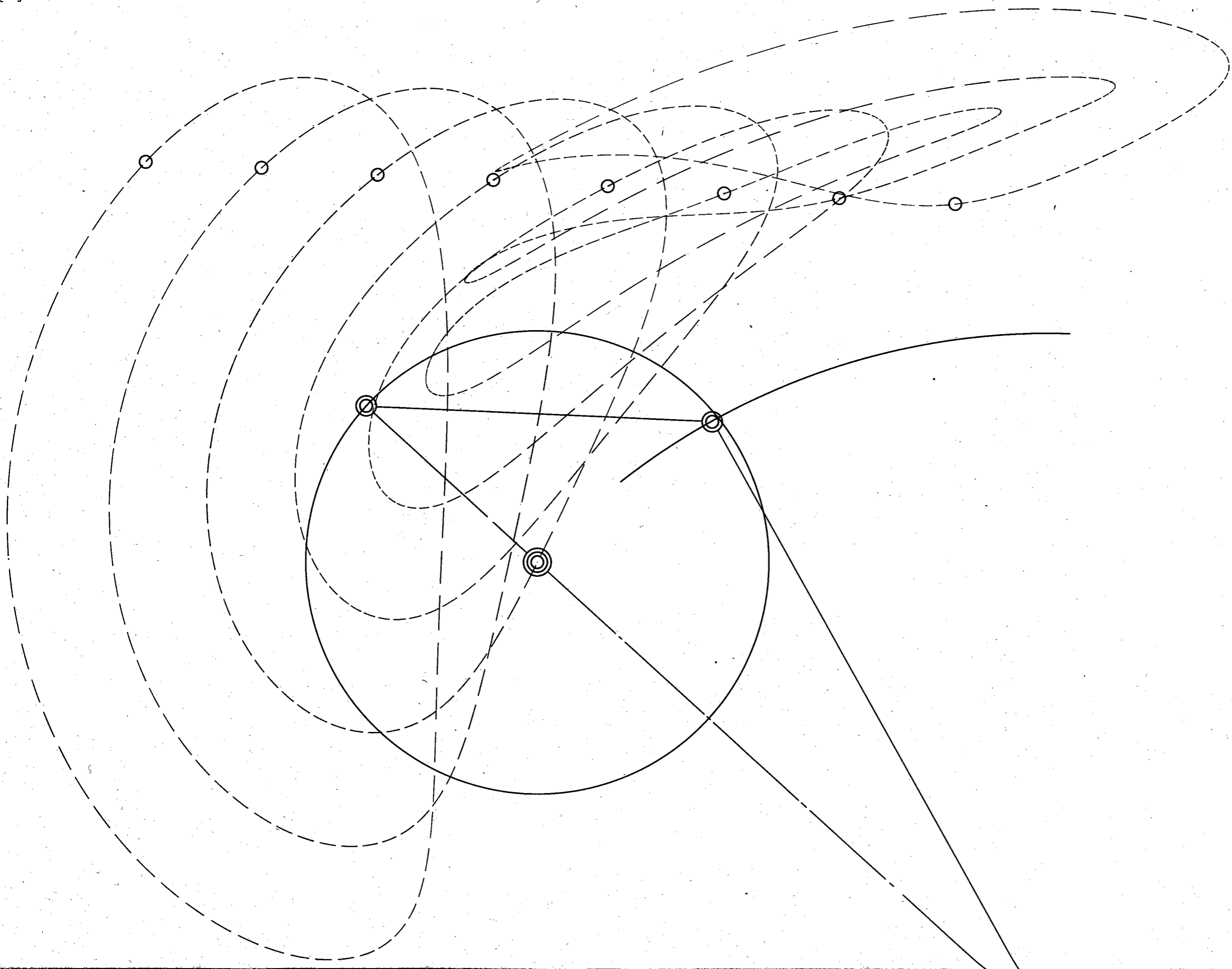
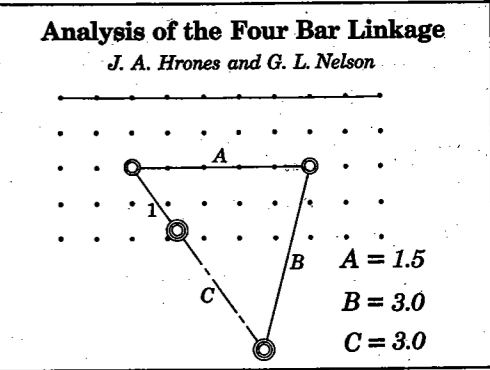

from  
Design of Machinery 4ed  
by Robert L. Norton  
McGraw-Hill  
Copyright 2008

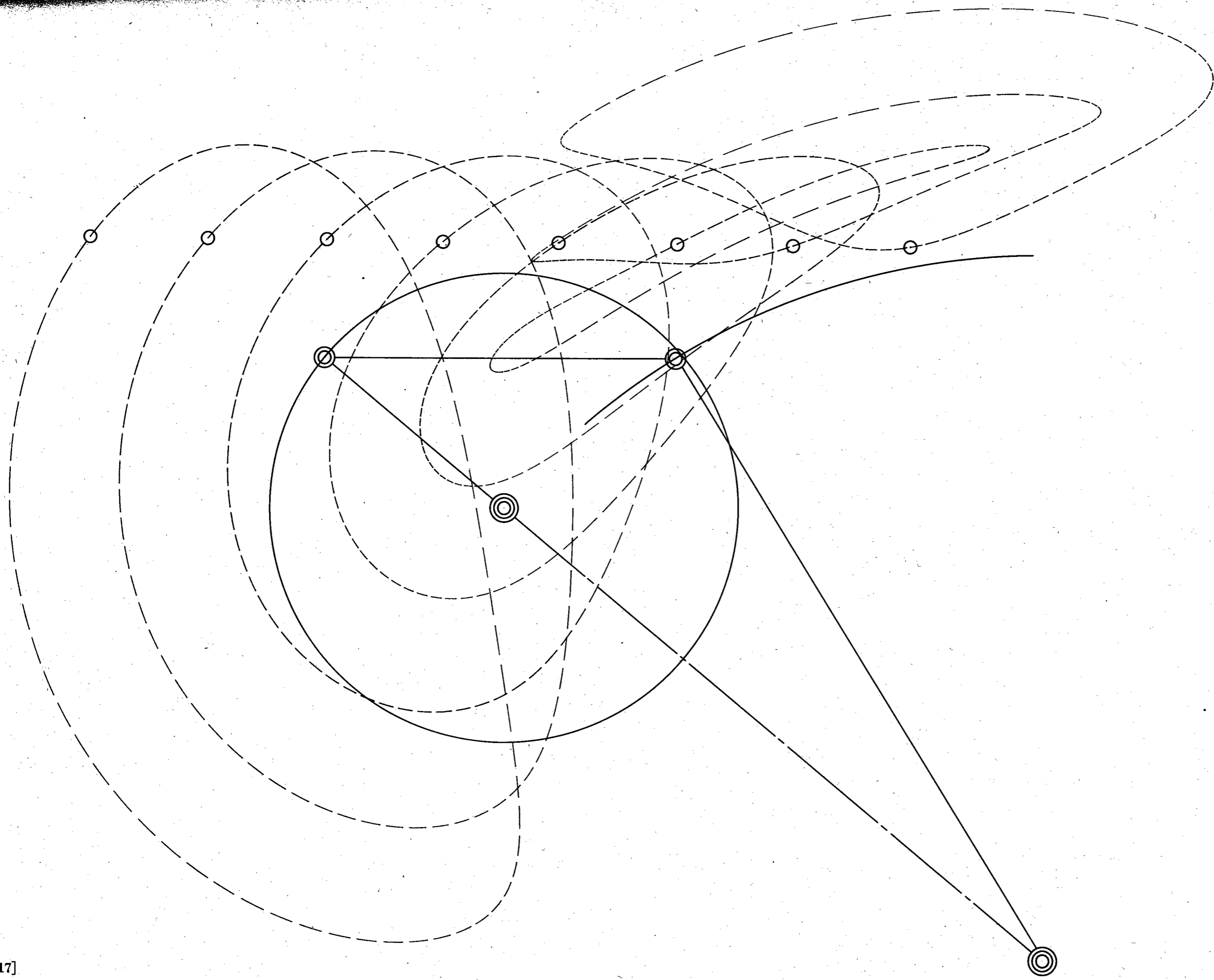
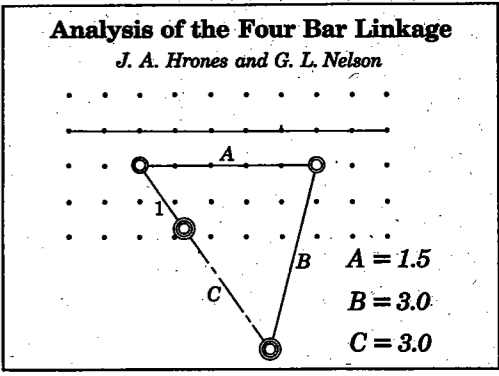

from  
 Design of Machinery 4ed  
 by Robert L. Norton  
 McGraw-Hill  
 Copyright 2008



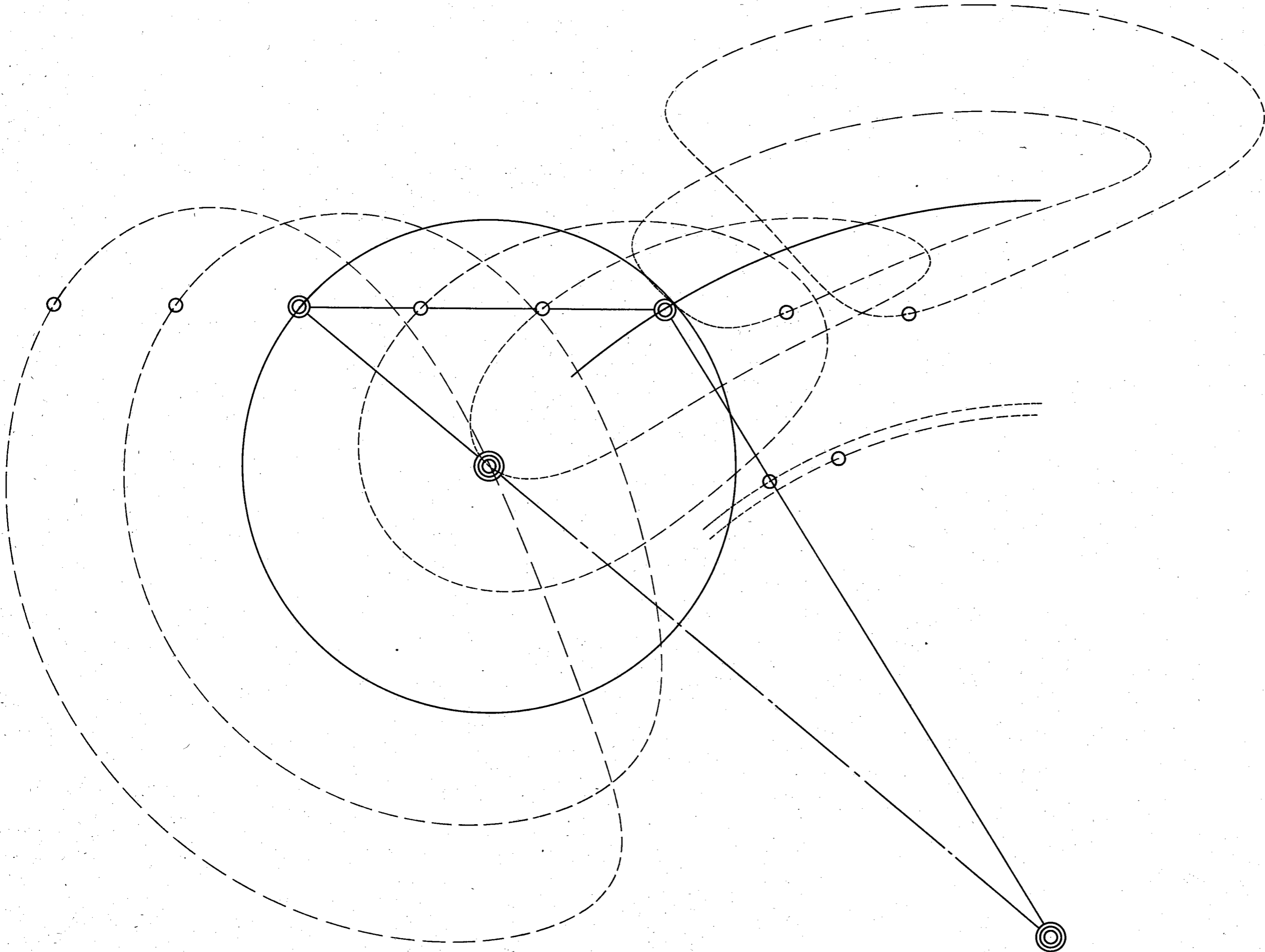
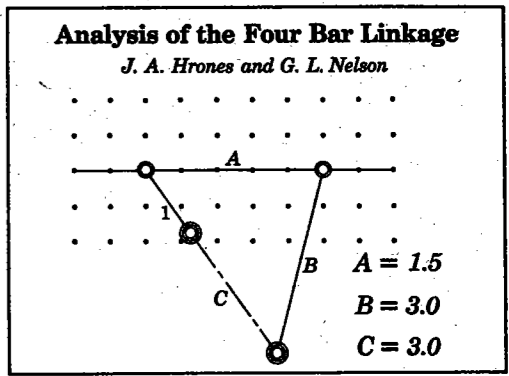

from  
Design of Machinery 4ed  
by Robert L. Norton  
McGraw-Hill  
Copyright 2008

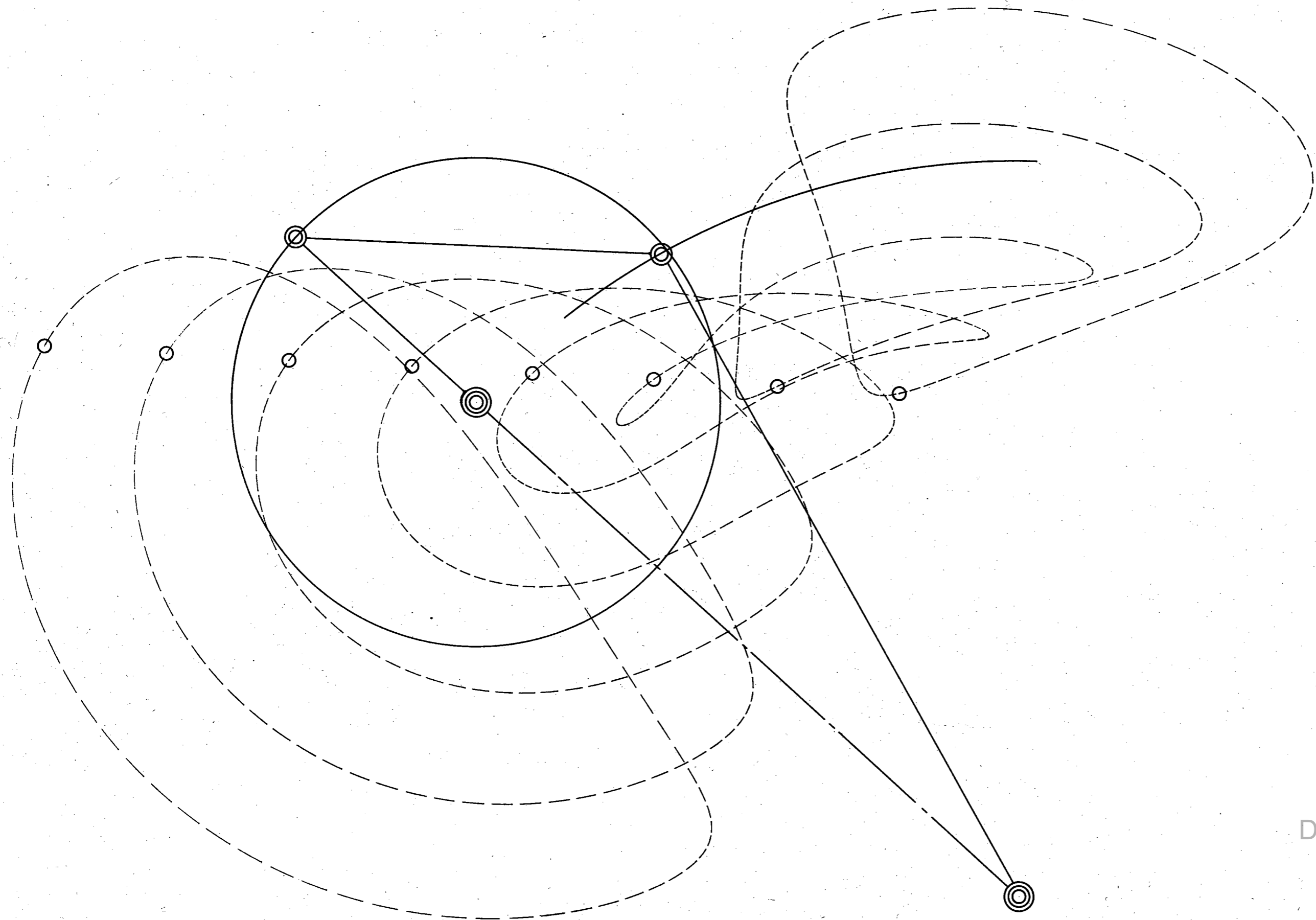
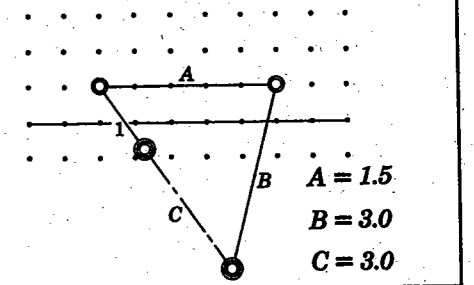

from  
Design of Machinery 4ed  
by Robert L. Norton  
McGraw-Hill  
Copyright 2008

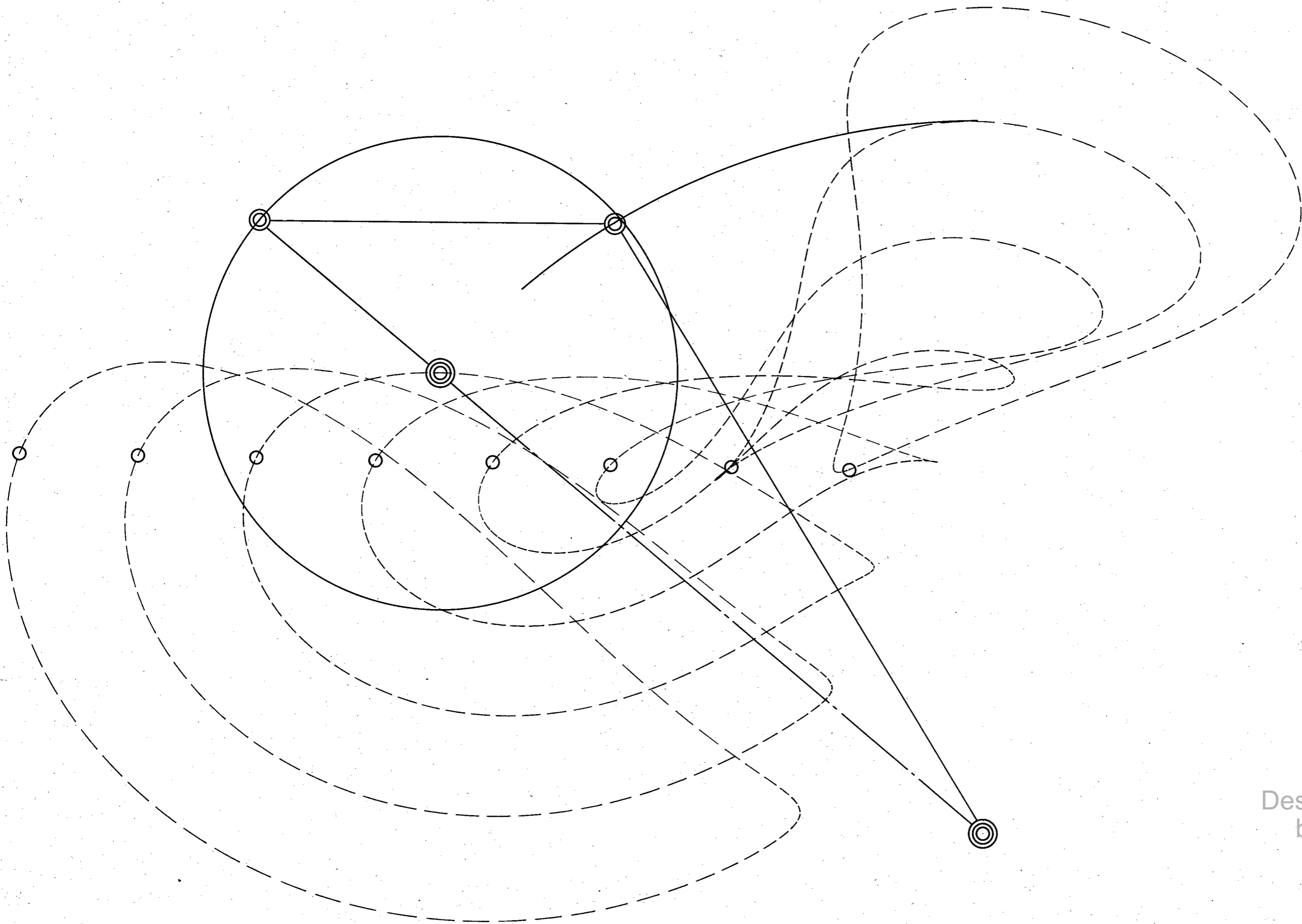
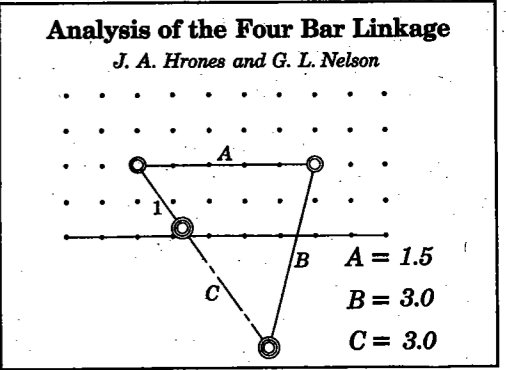

from  
Design of Machinery 4ed  
by Robert L. Norton  
McGraw-Hill  
Copyright 2008

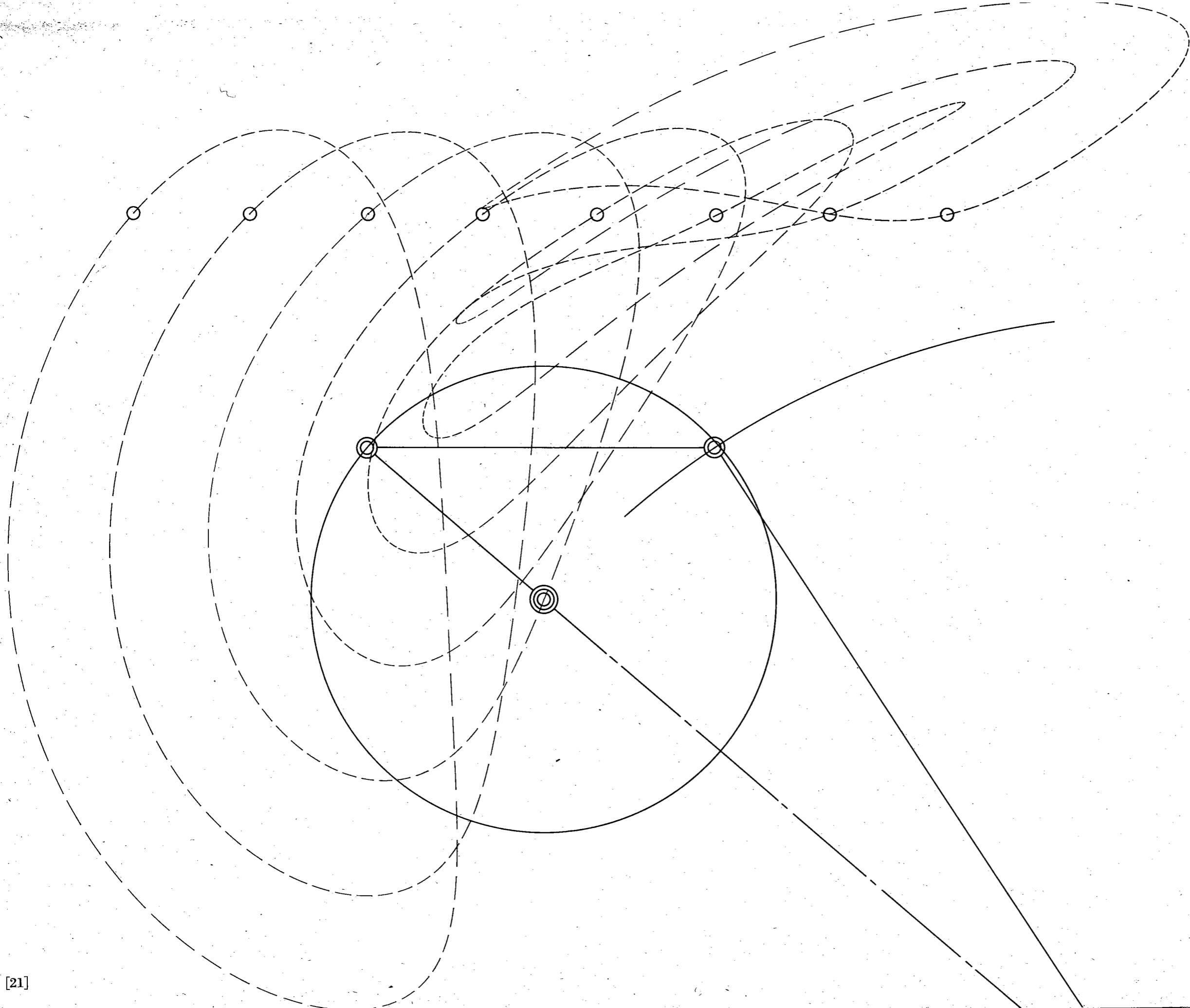
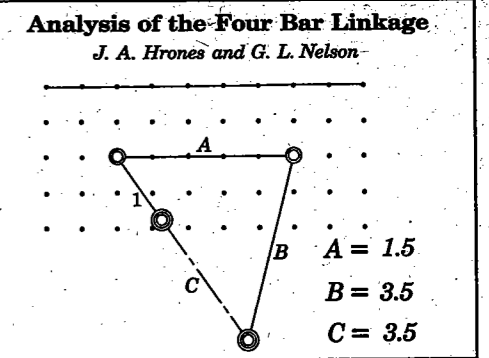

from  
 Design of Machinery 4ed  
 by Robert L. Norton  
 McGraw-Hill  
 Copyright 2008

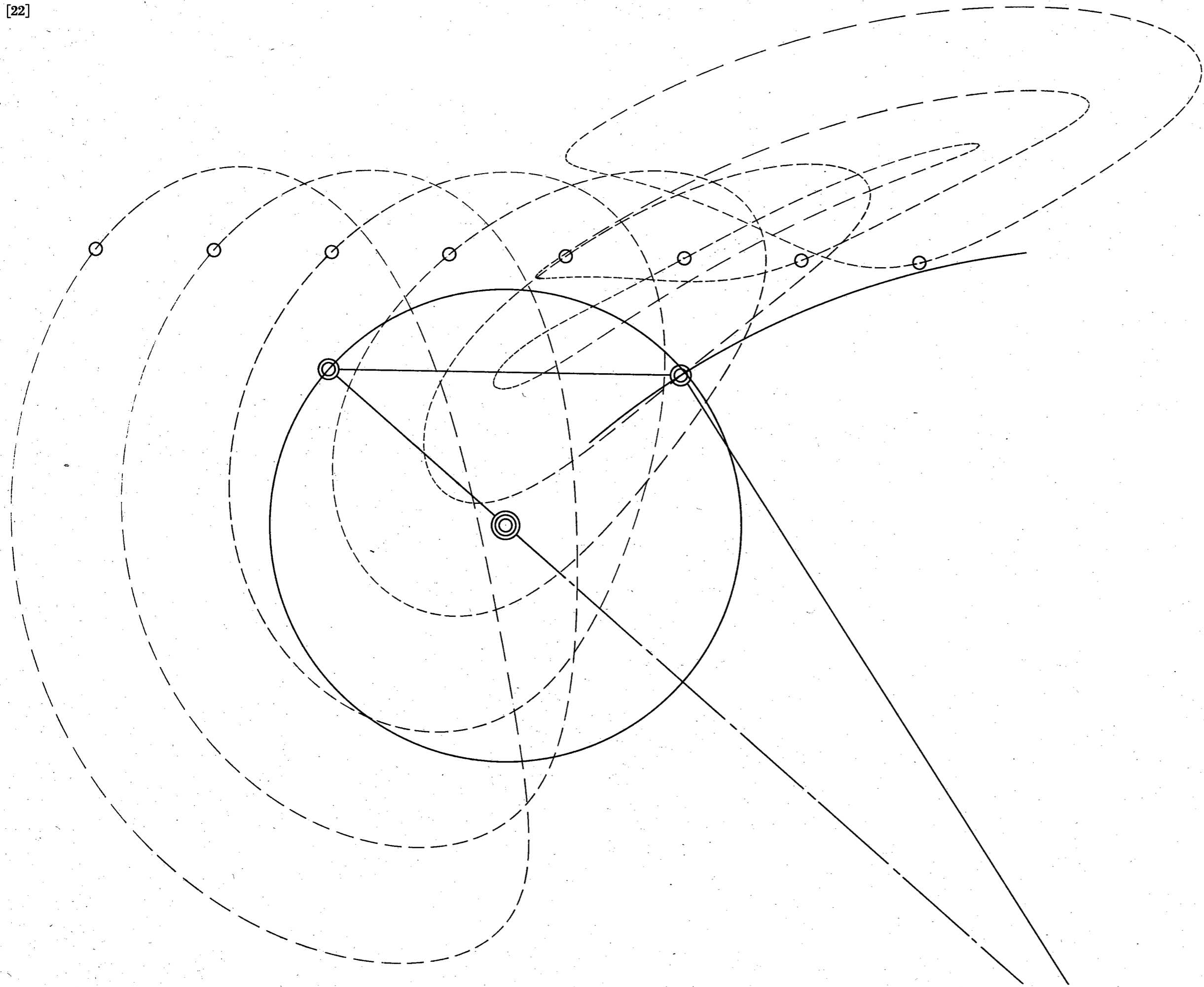
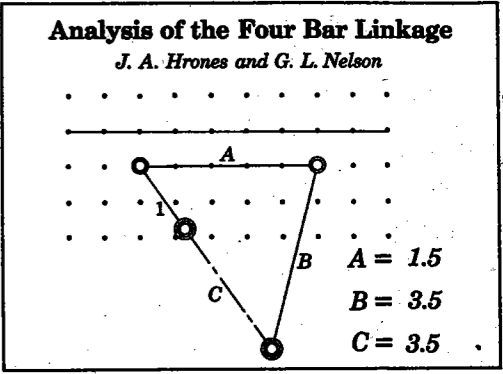

from  
Design of Machinery 4ed  
by Robert L. Norton  
McGraw-Hill  
Copyright 2008

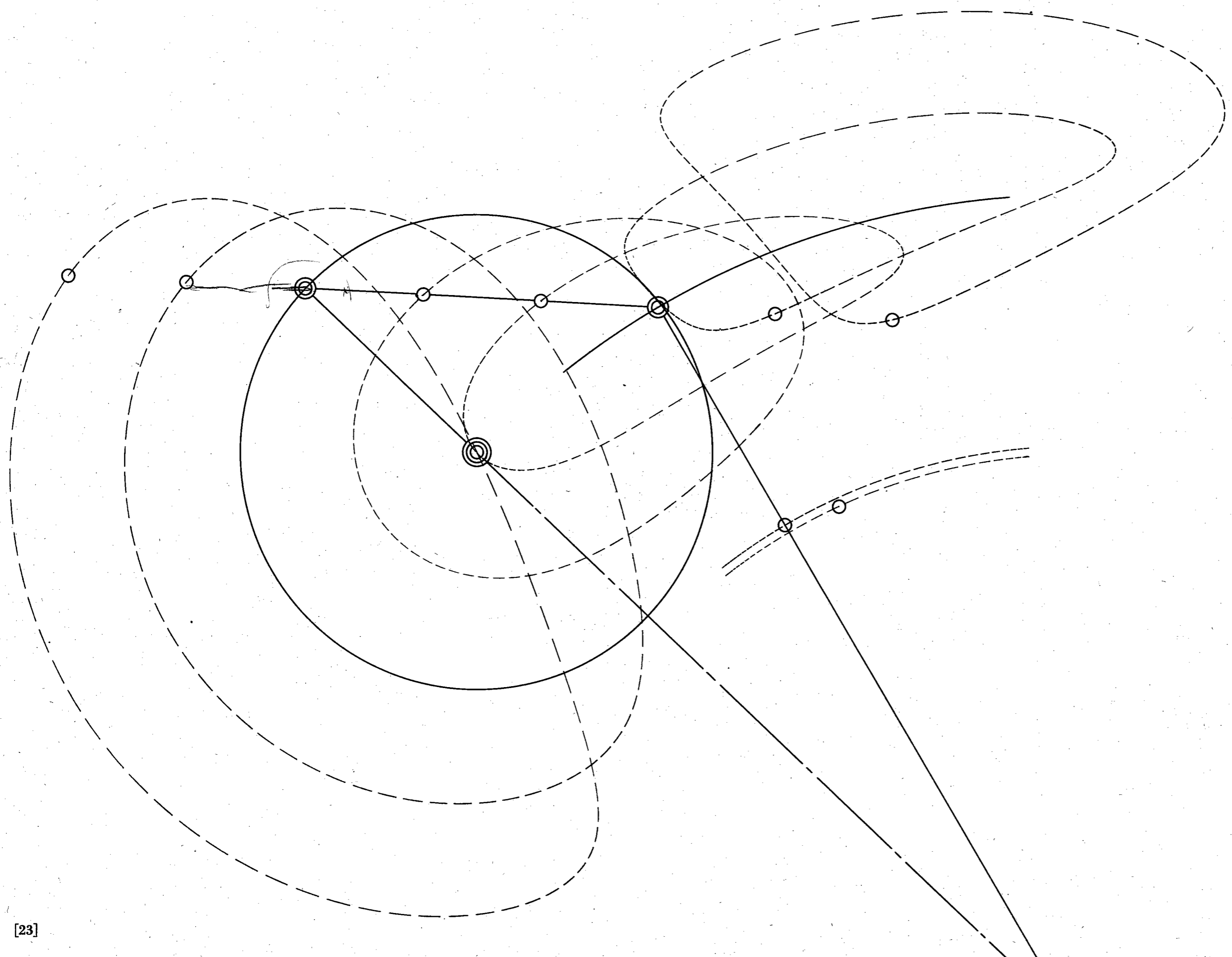
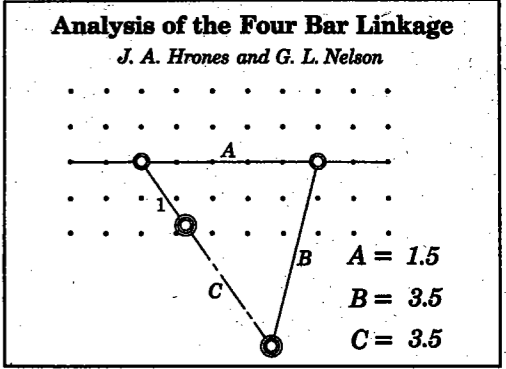

from  
 Design of Machinery 4ed  
 by Robert L. Norton  
 McGraw-Hill  
 Copyright 2008

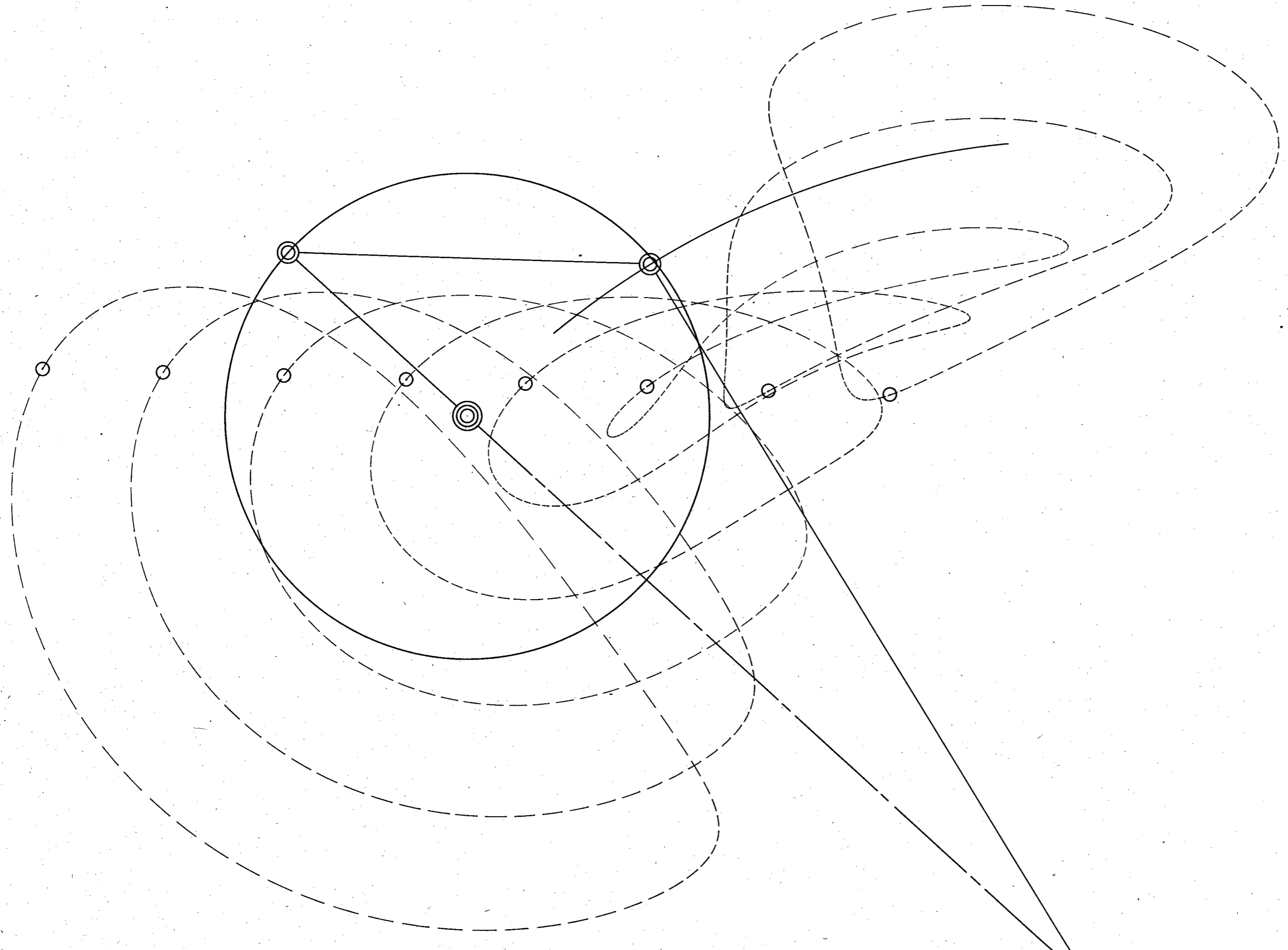
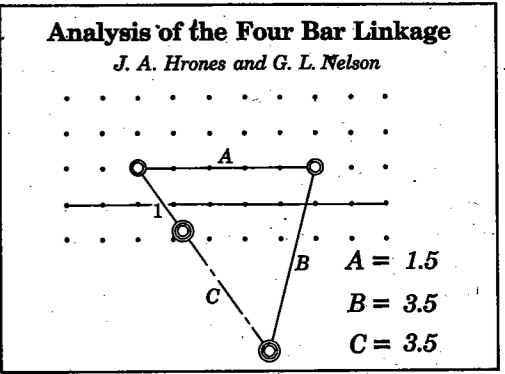

from  
Design of Machinery 4ed  
by Robert L. Norton  
McGraw-Hill  
Copyright 2008

Analysis of the Four Bar Linkage

J. A. Hrones and G. L. Nelson

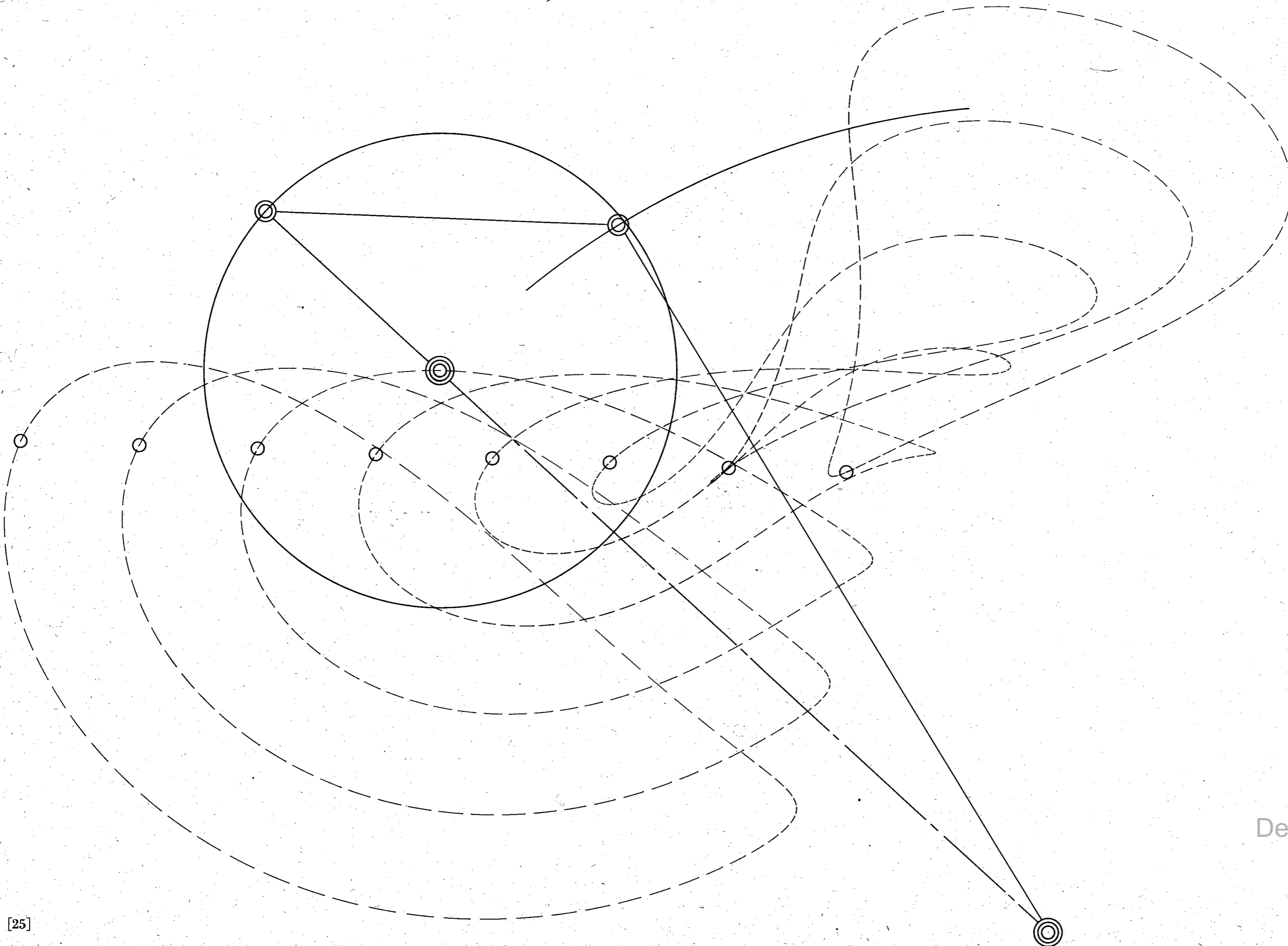
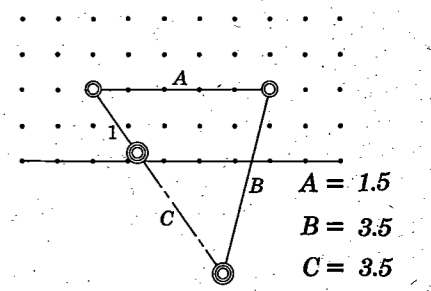

from  
Design of Machinery 4ed  
by Robert L. Norton  
McGraw-Hill  
Copyright 2008



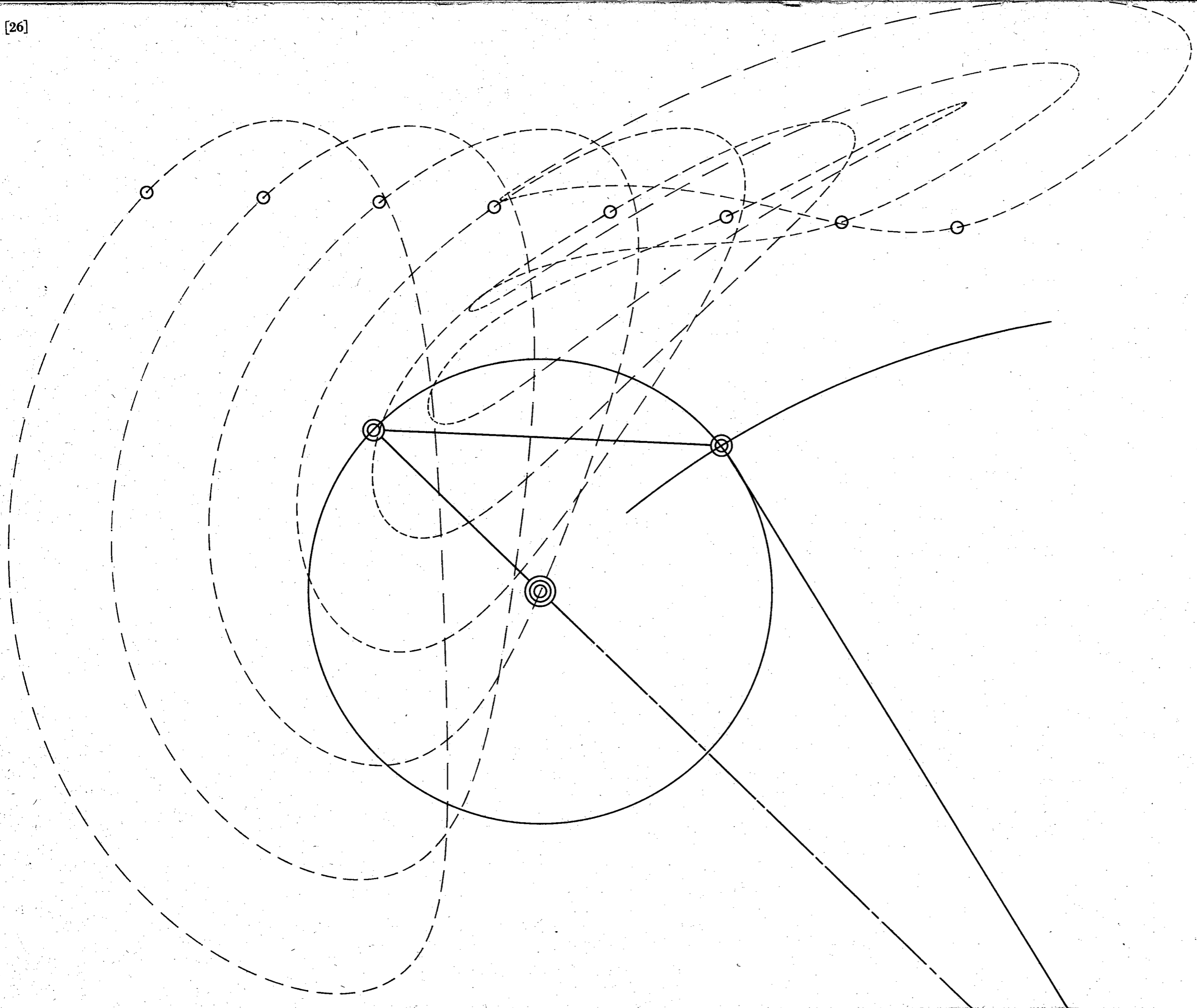
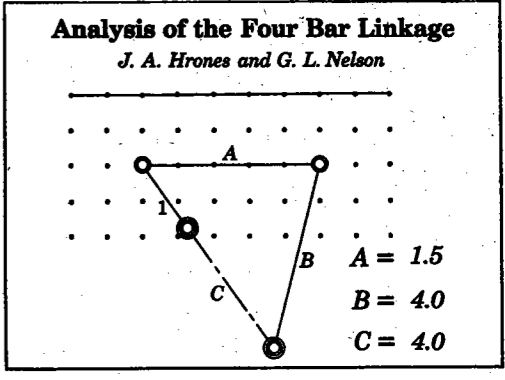

from  
Design of Machinery 4ed  
by Robert L. Norton  
McGraw-Hill  
Copyright 2008

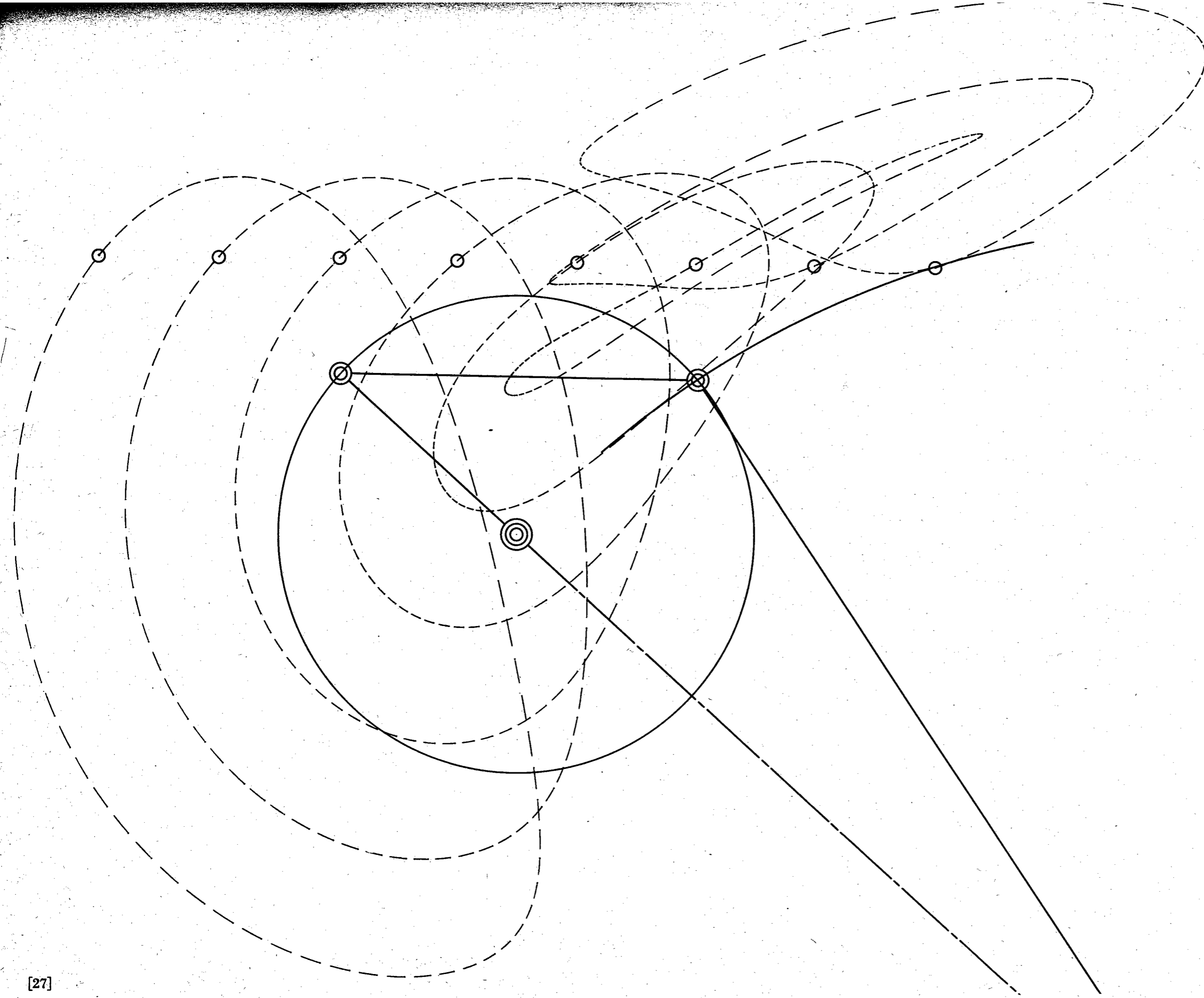
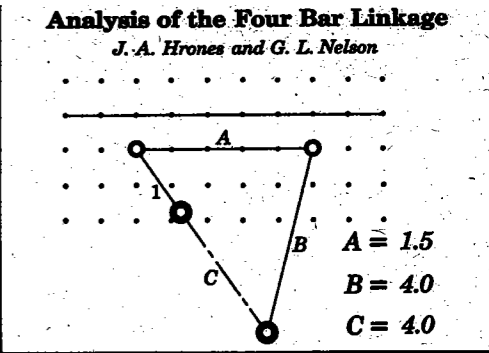

from  
 Design of Machinery 4ed  
 by Robert L. Norton  
 McGraw-Hill  
 Copyright 2008

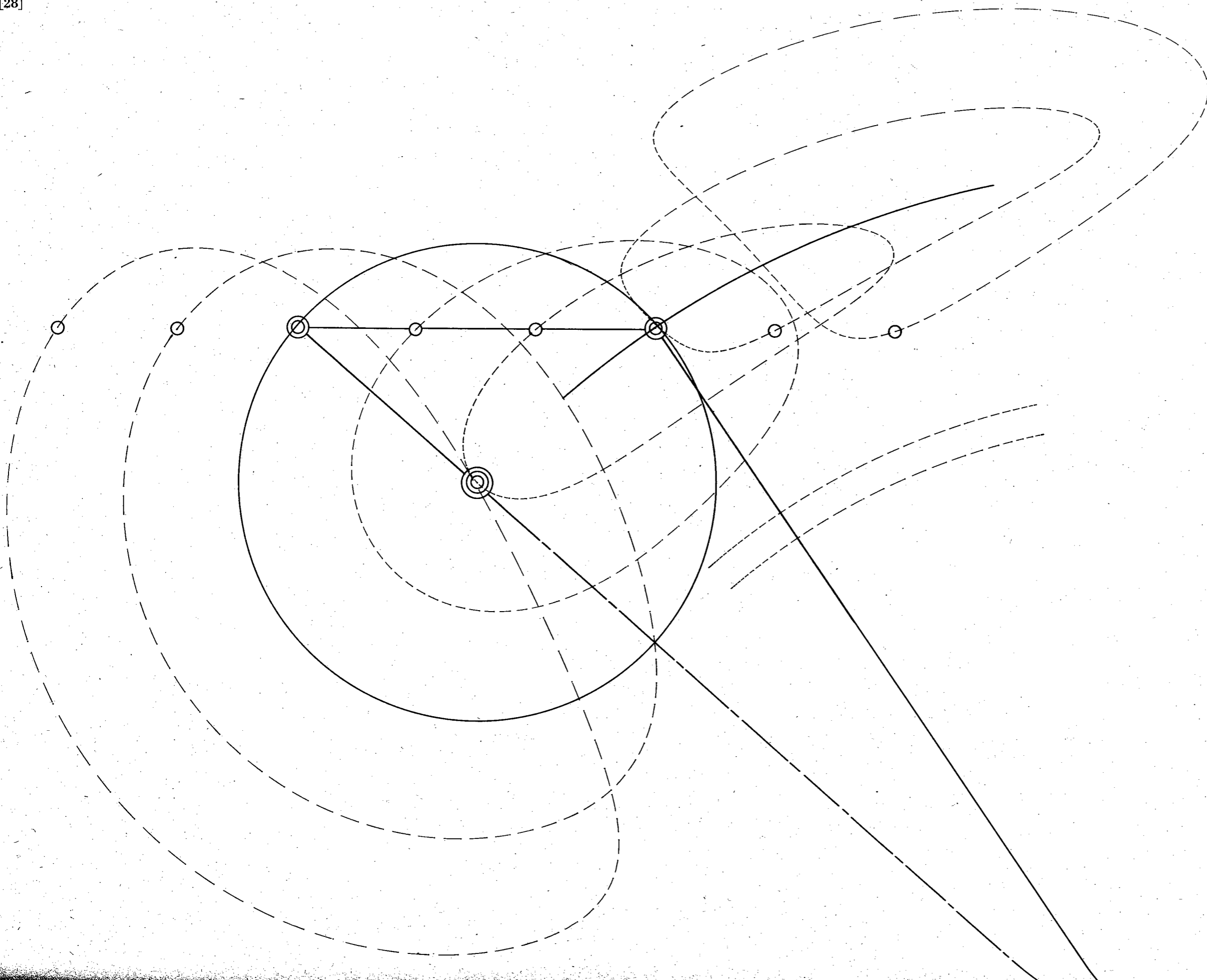
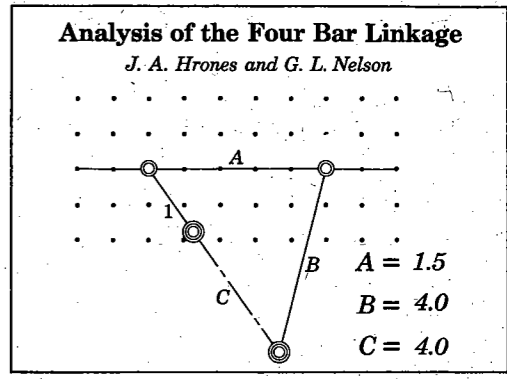

from  
Design of Machinery 4ed  
by Robert L. Norton  
McGraw-Hill  
Copyright 2008

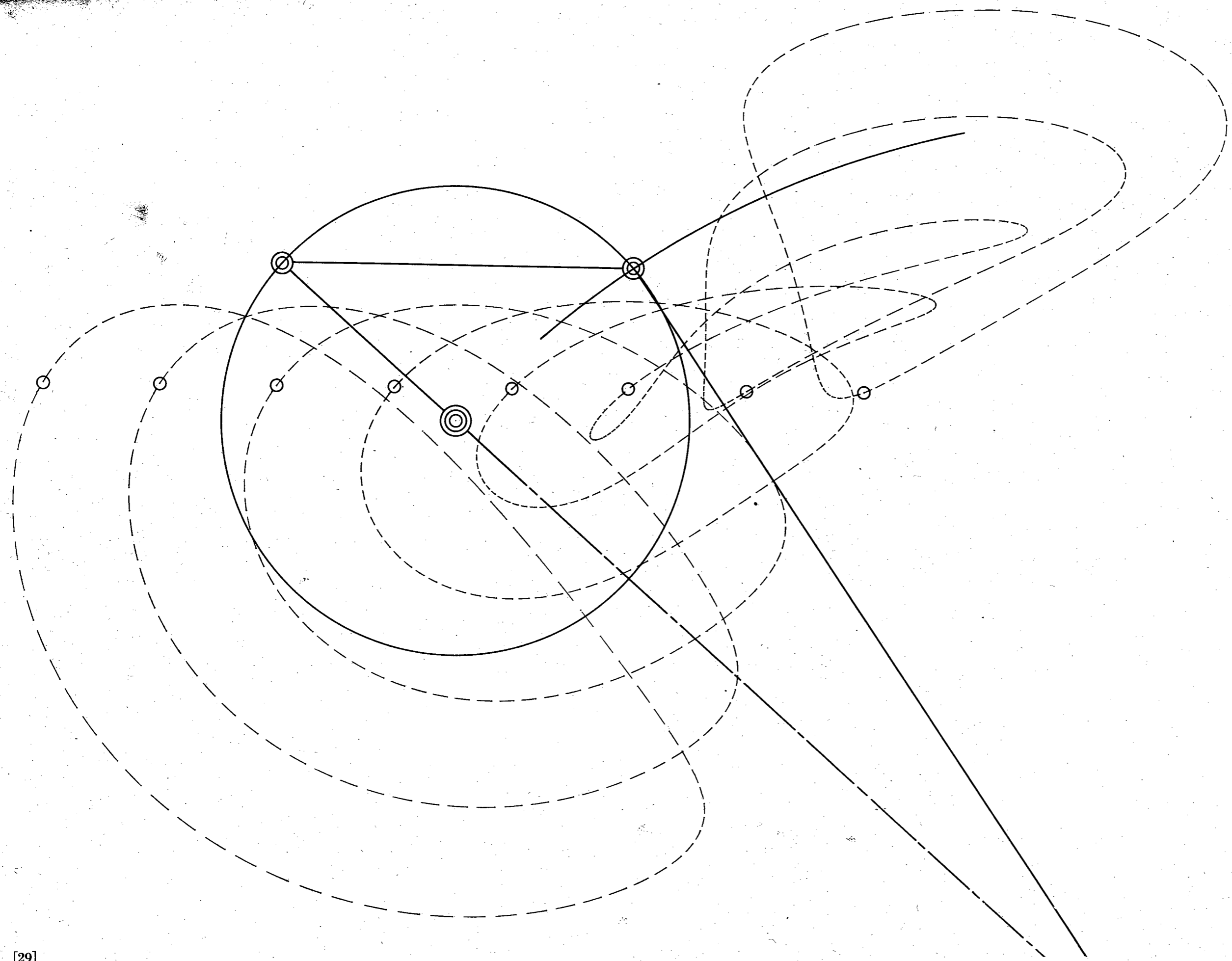
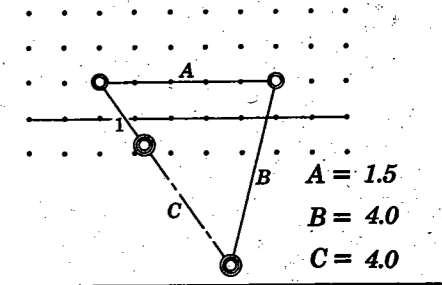

from  
Design of Machinery 4ed  
by Robert L. Norton  
McGraw-Hill  
Copyright 2008

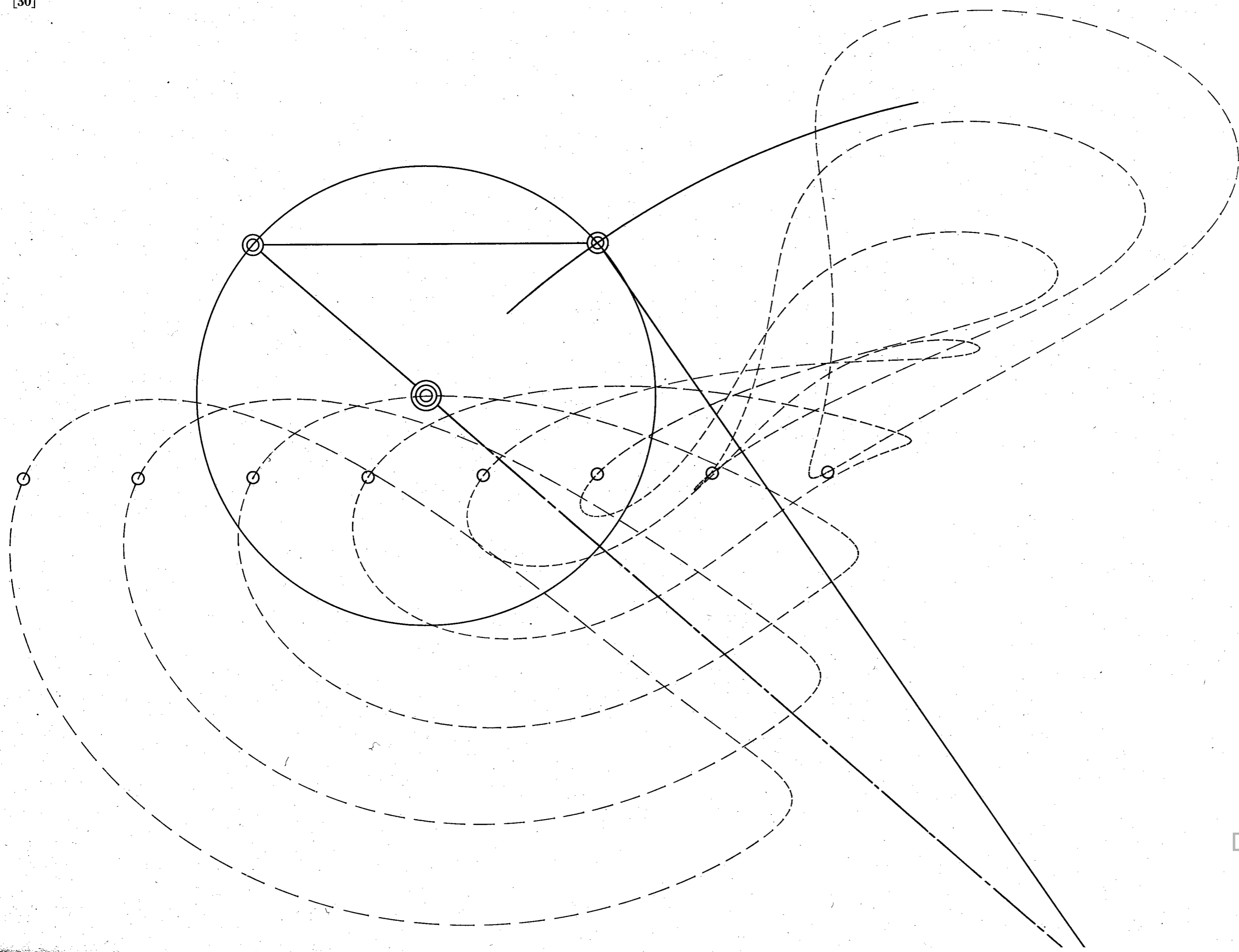
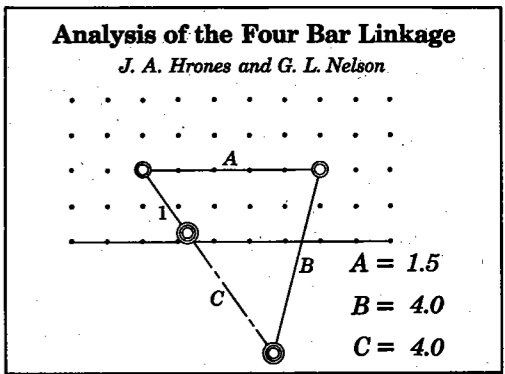

from  
Design of Machinery 4ed  
by Robert L. Norton  
McGraw-Hill  
Copyright 2008

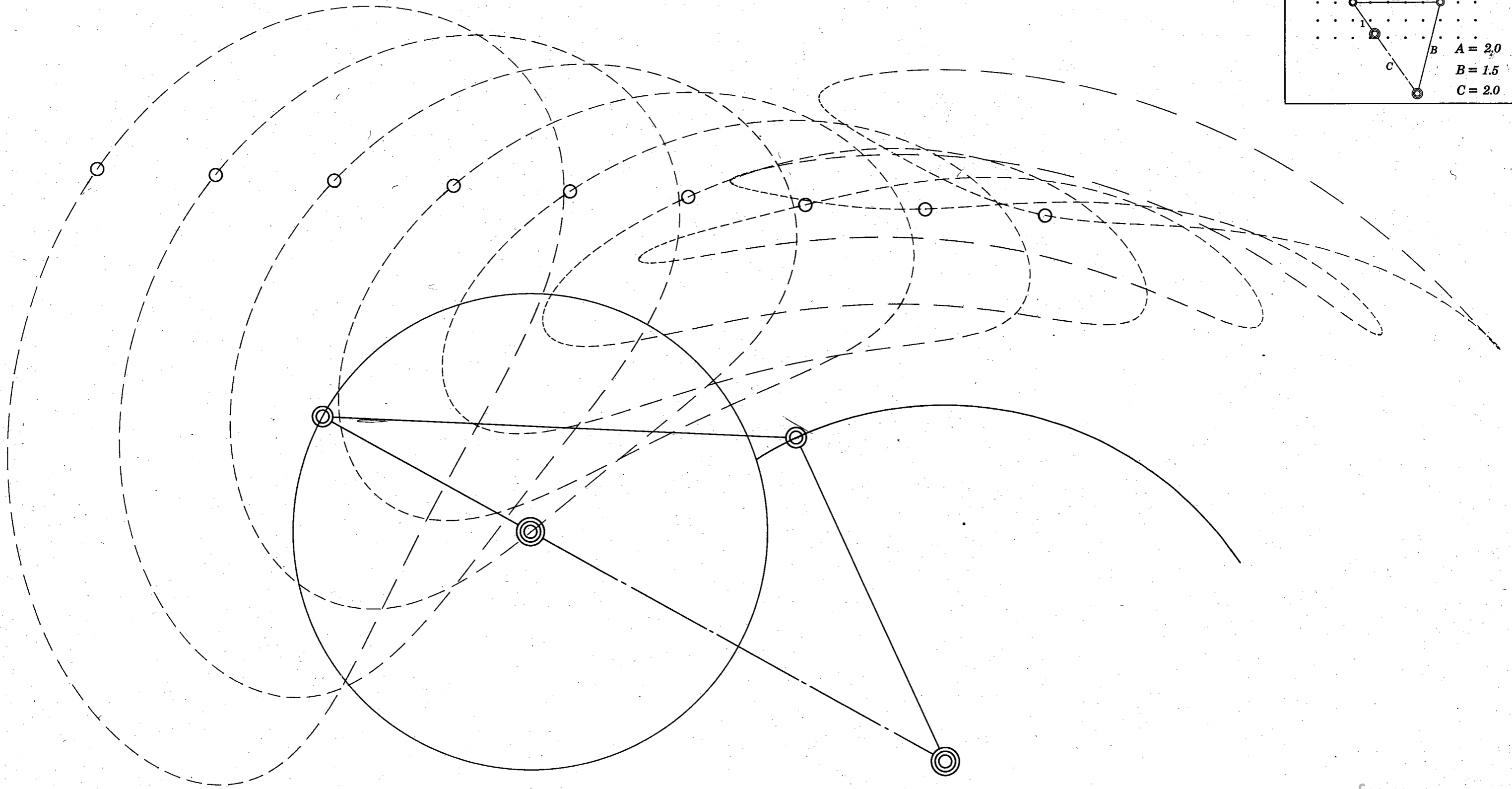
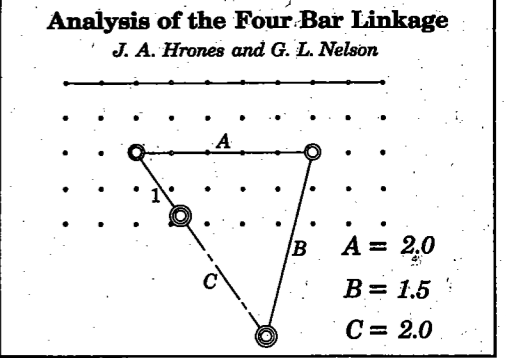

from  
 Design of Machinery 4ed  
 by Robert L. Norton  
 McGraw-Hill  
 Copyright 2008

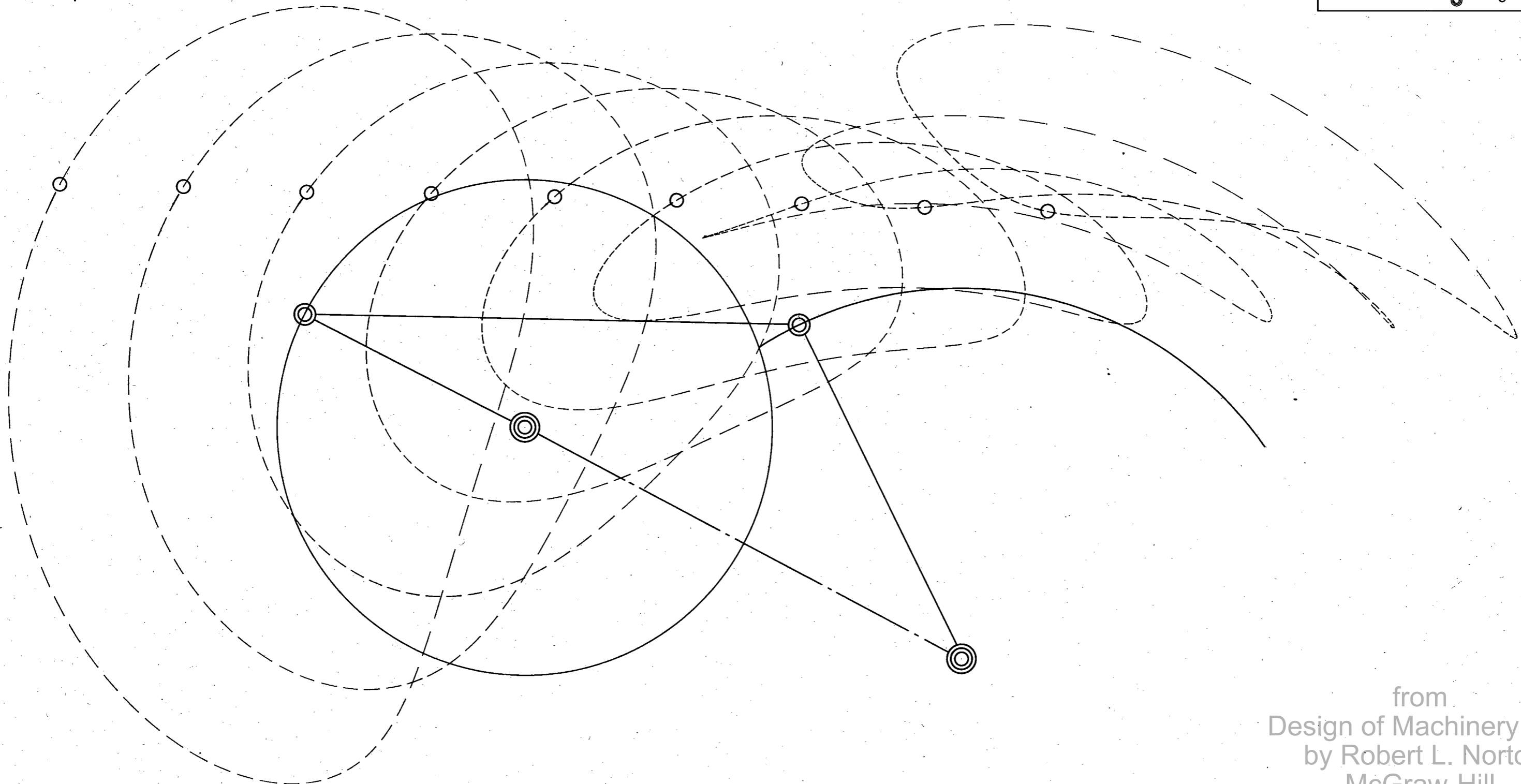
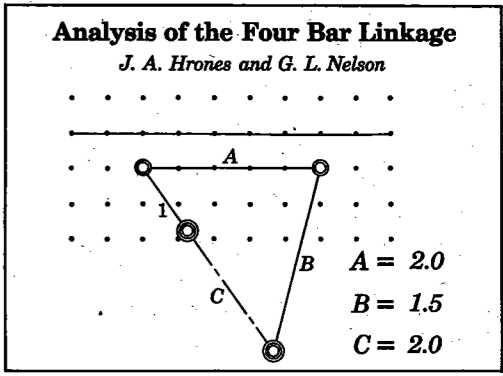

from  
Design of Machinery 4ed  
by Robert L. Norton  
McGraw-Hill  
Copyright 2008

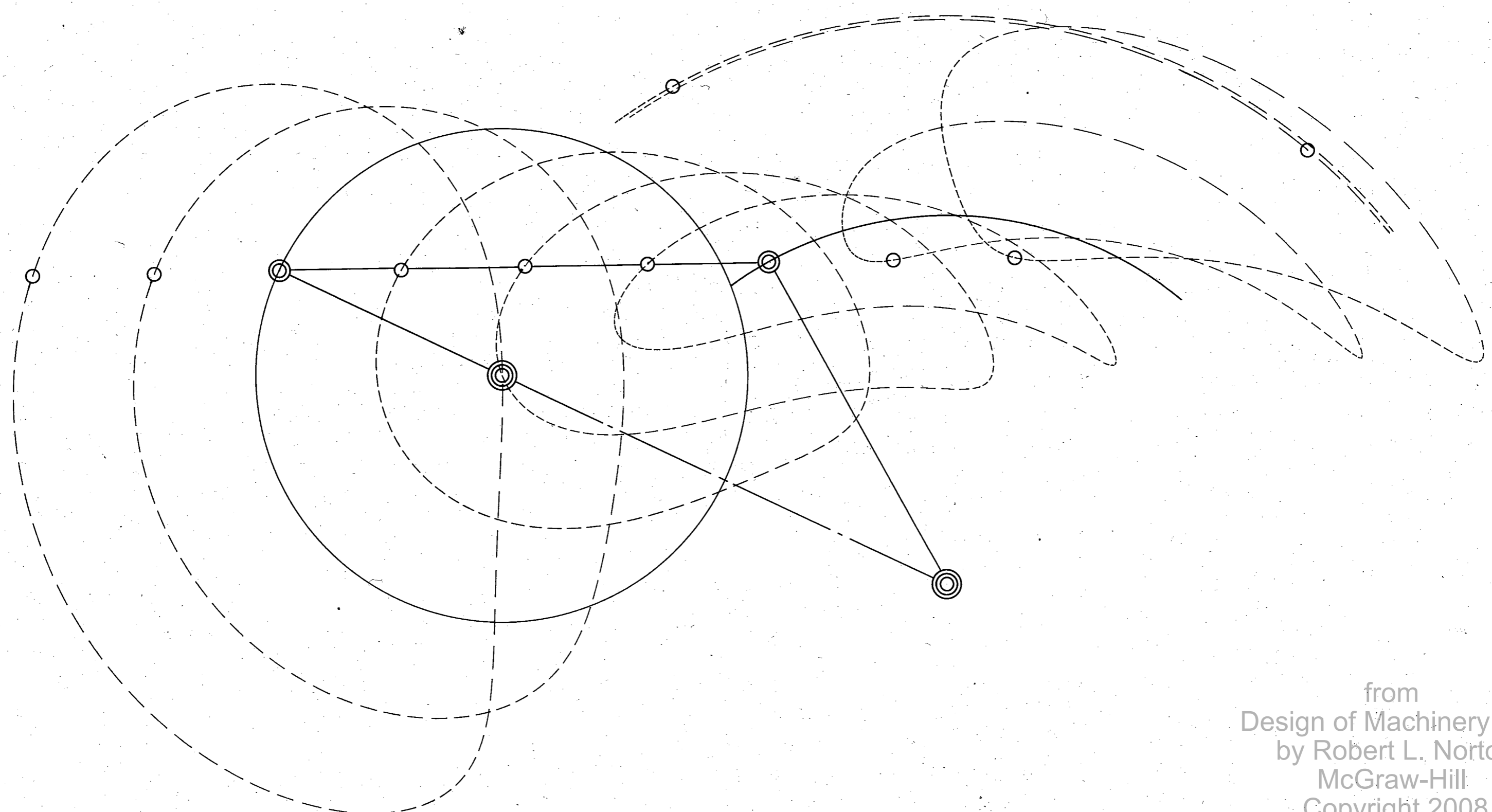
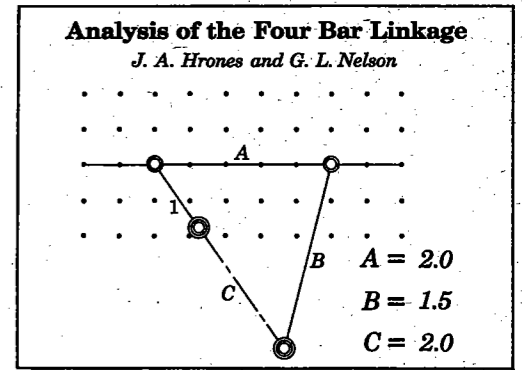

from  
 Design of Machinery 4ed  
 by Robert L. Norton  
 McGraw-Hill  
 Copyright 2008



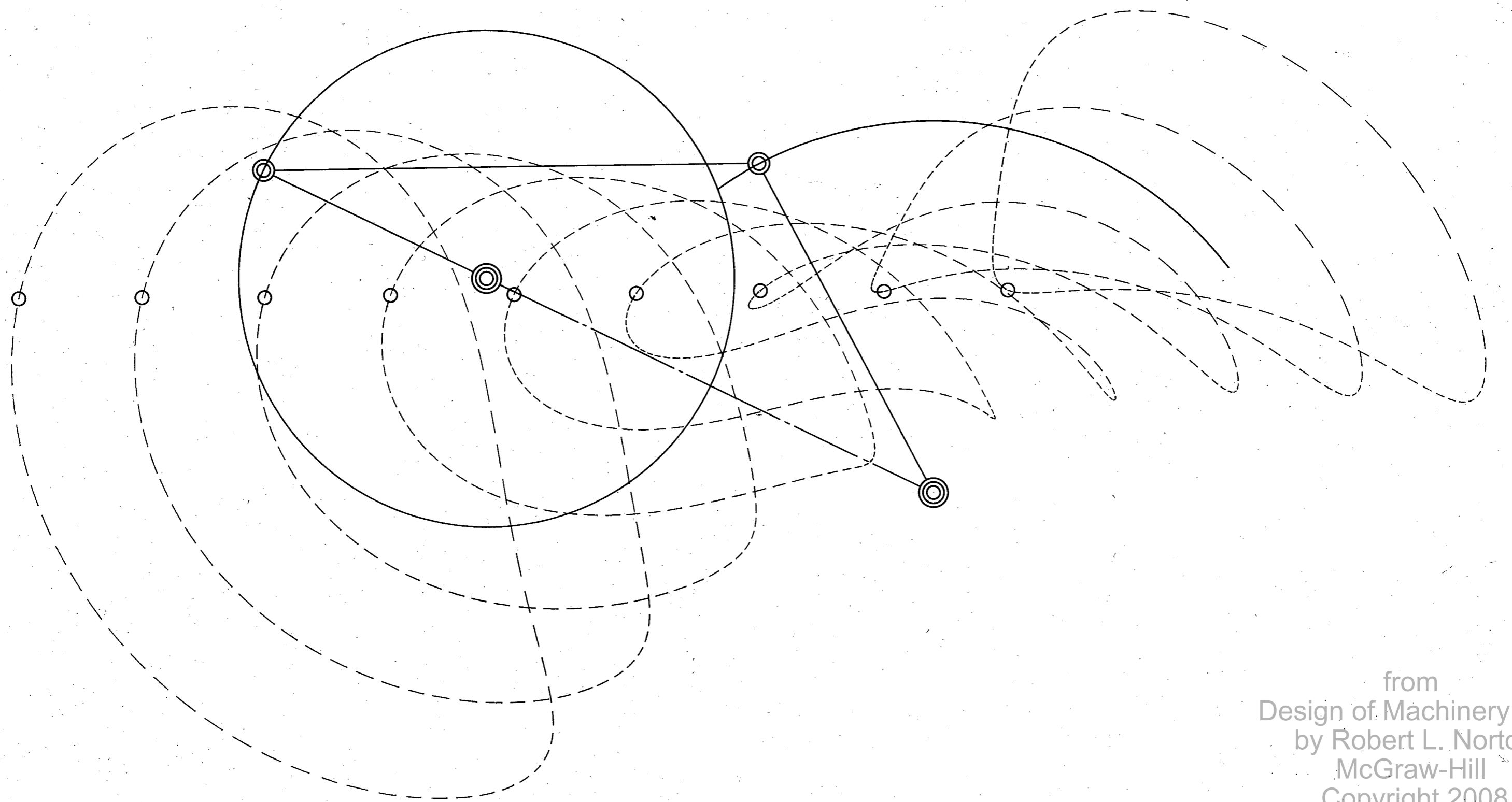
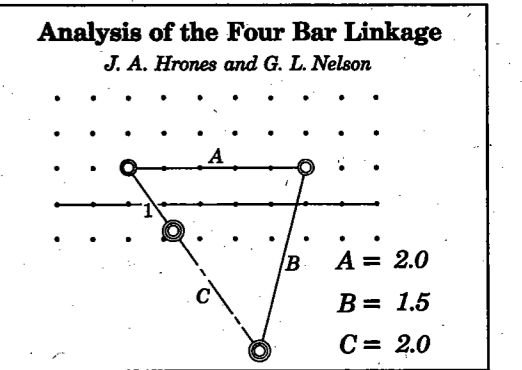

from  
Design of Machinery 4ed  
by Robert L. Norton  
McGraw-Hill  
Copyright 2008

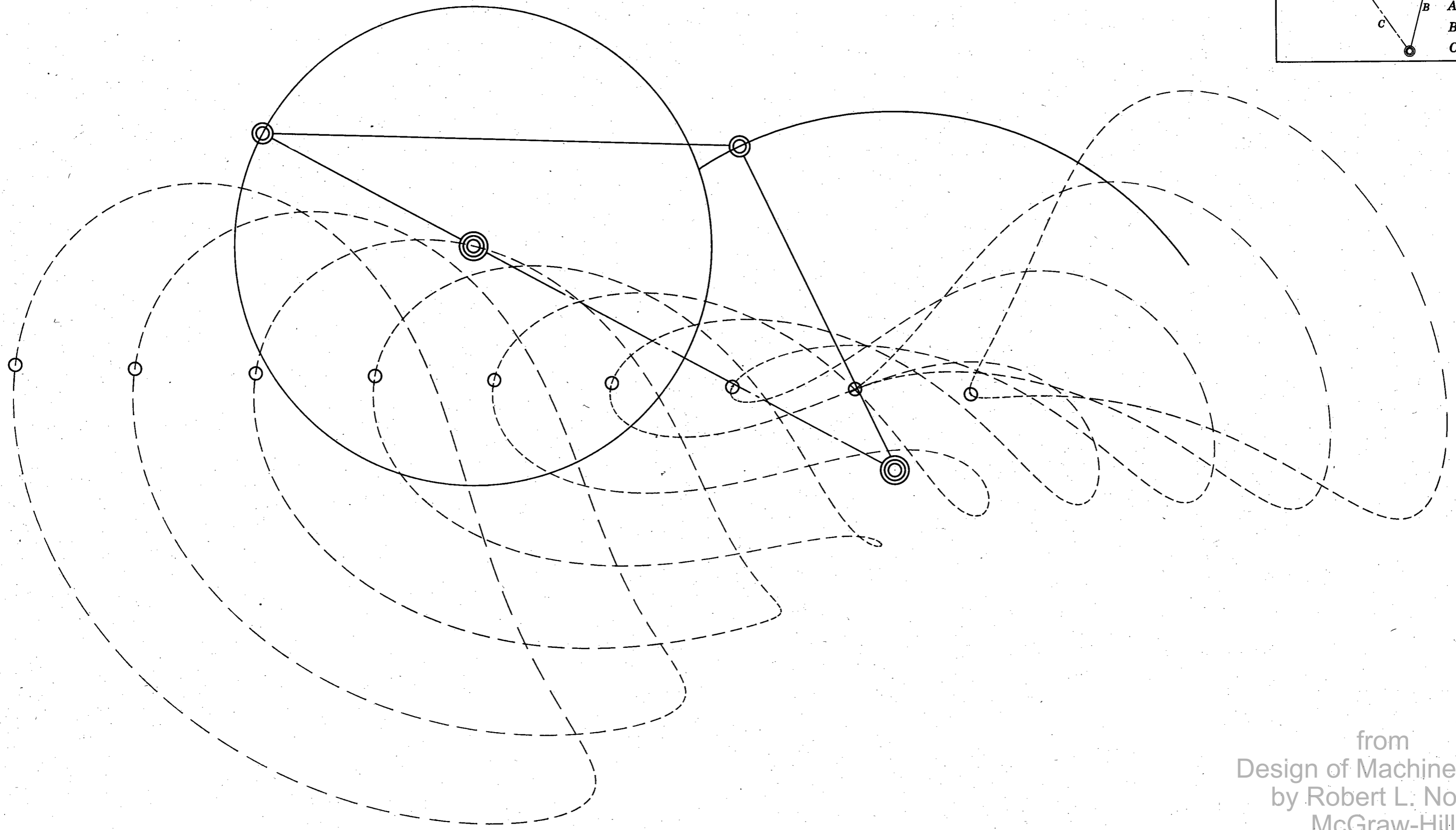
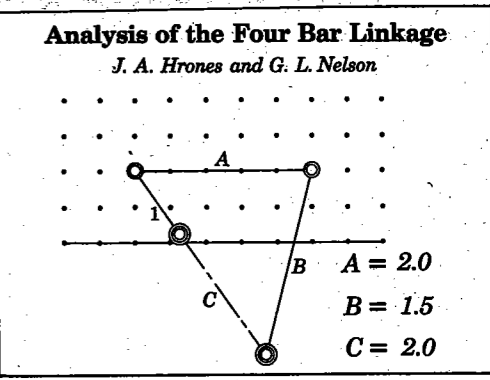

from  
 Design of Machinery 4ed  
 by Robert L. Norton  
 McGraw-Hill  
 Copyright 2008

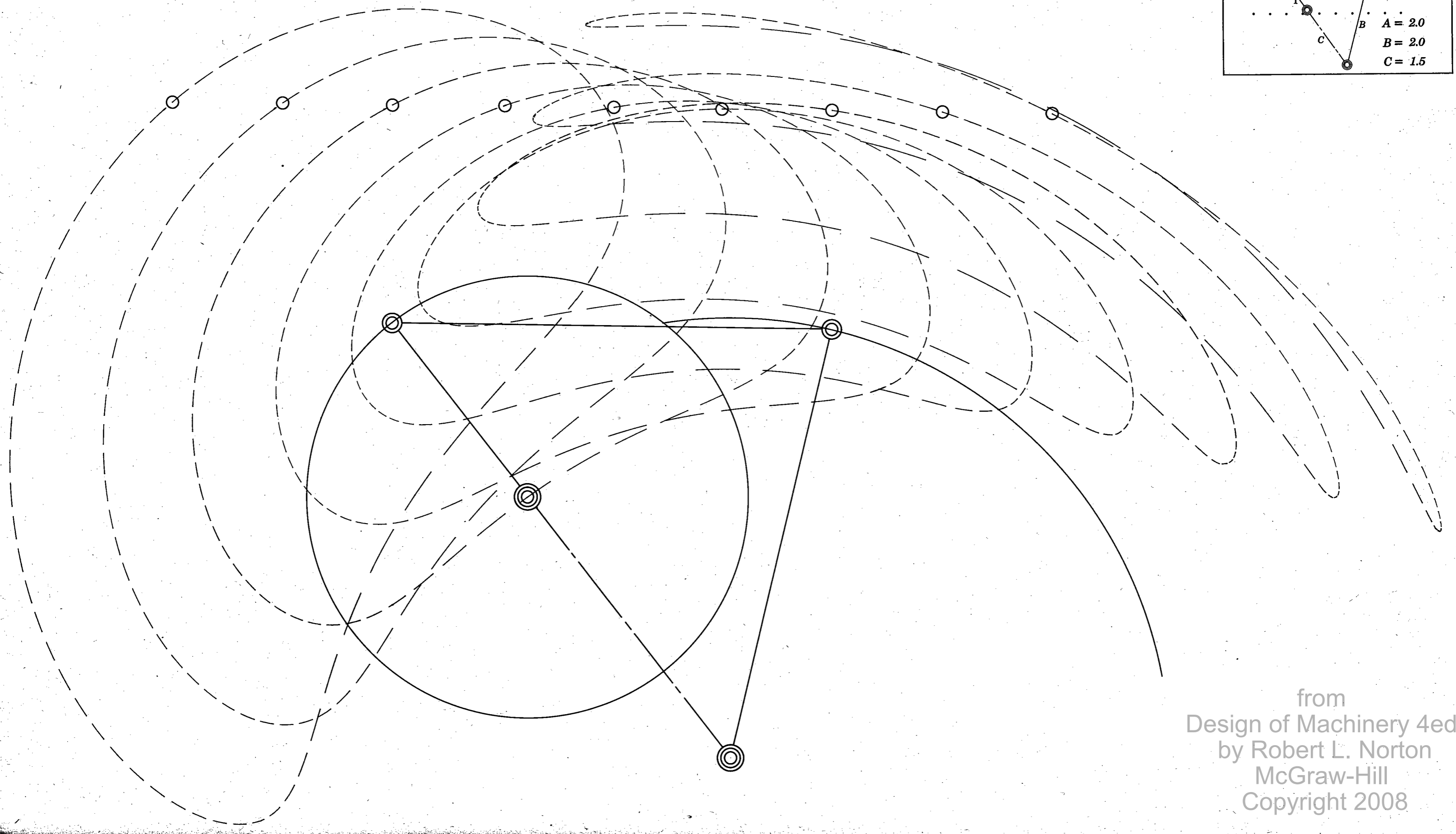
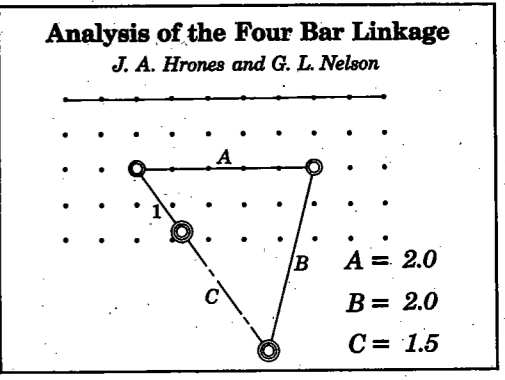

from  
Design of Machinery 4ed  
by Robert L. Norton  
McGraw-Hill  
Copyright 2008

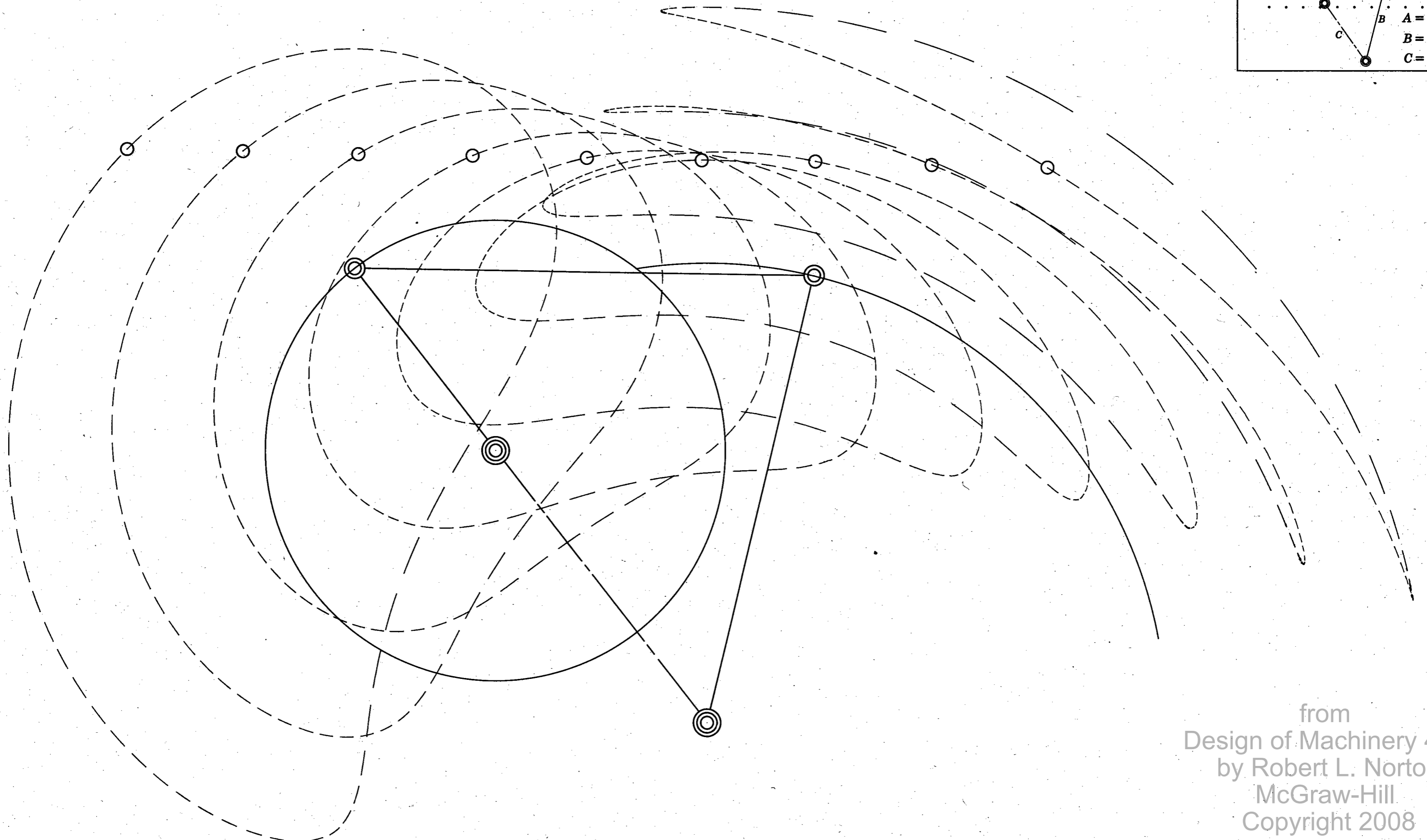
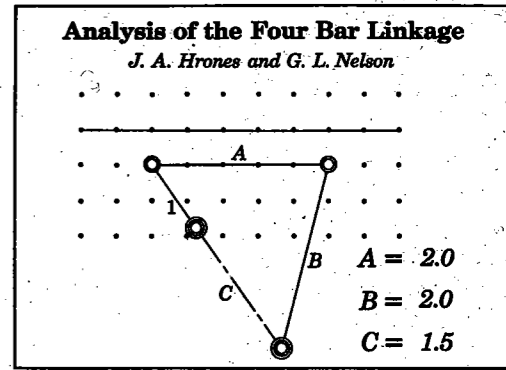

from  
 Design of Machinery 4ed  
 by Robert L. Norton  
 McGraw-Hill  
 Copyright 2008

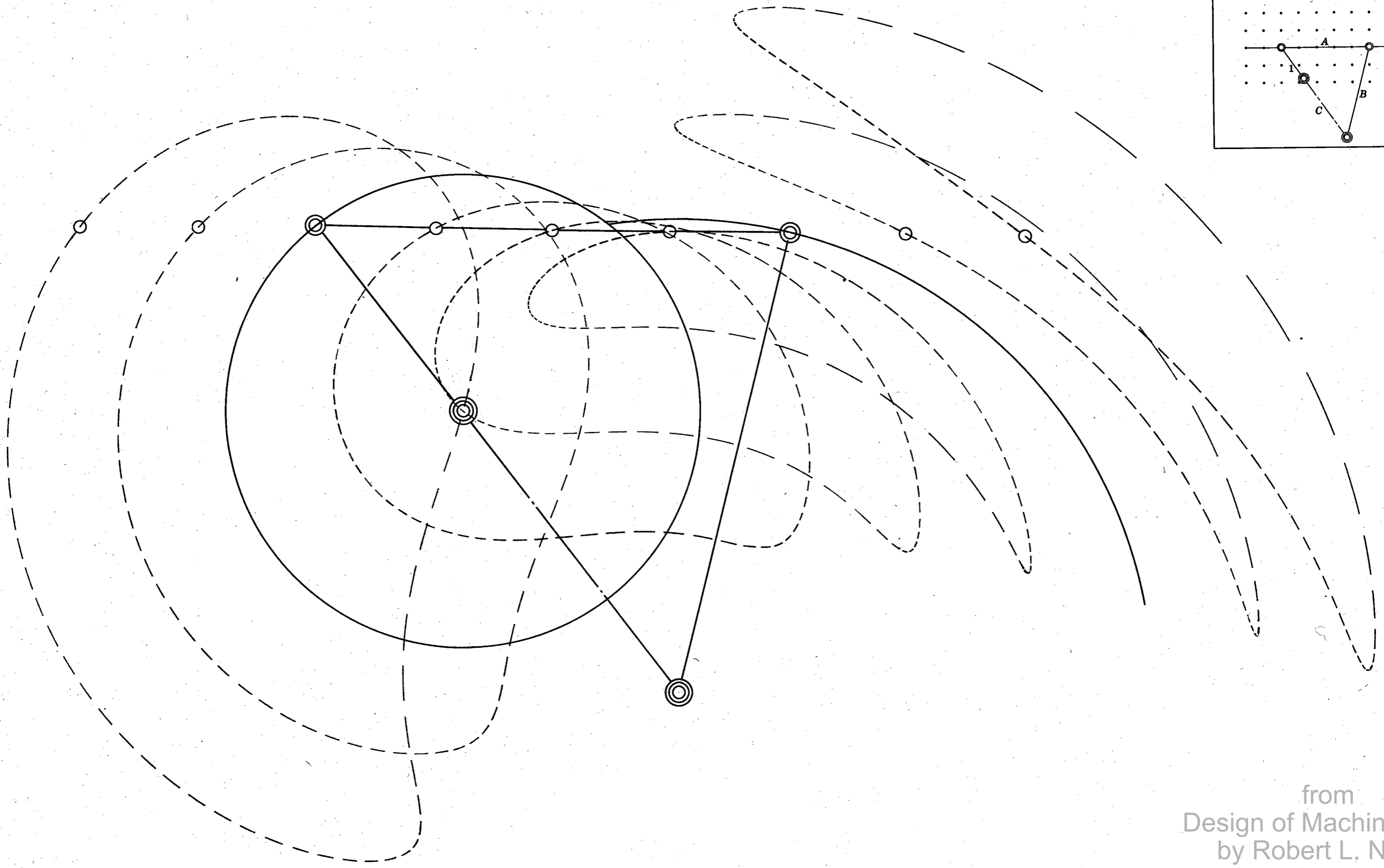
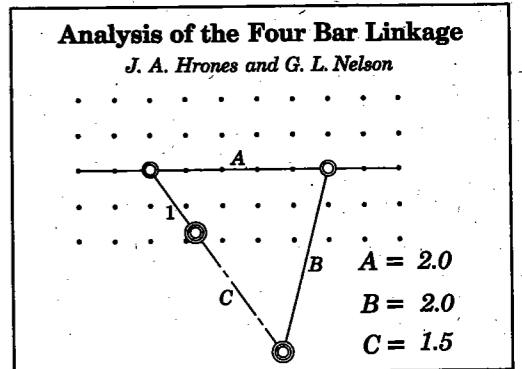

from  
Design of Machinery 4ed  
by Robert L. Norton  
McGraw-Hill  
Copyright 2008

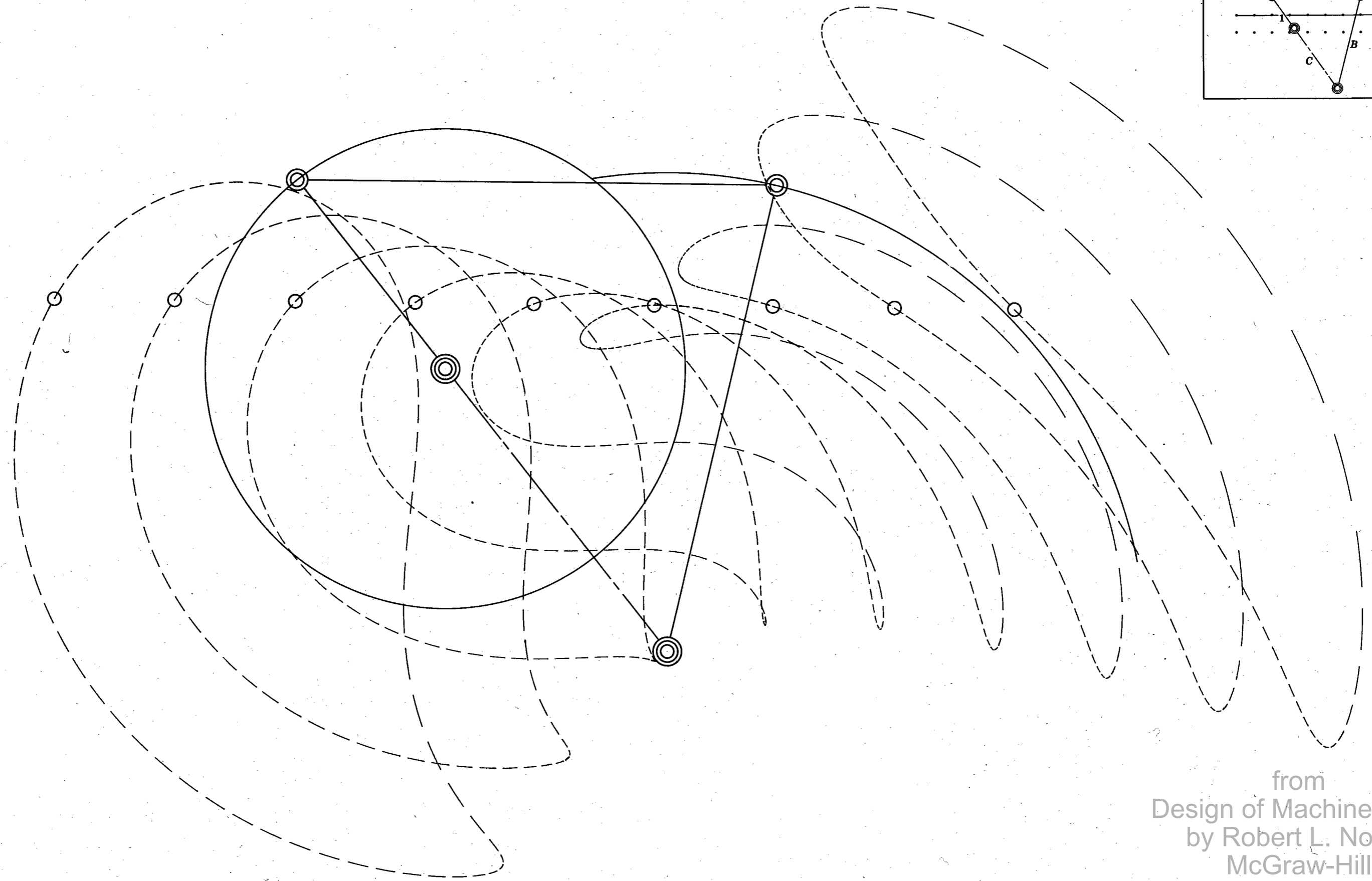
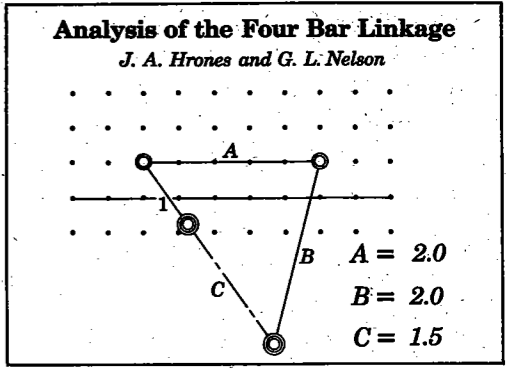

from  
 Design of Machinery 4ed  
 by Robert L. Norton  
 McGraw-Hill  
 Copyright 2008

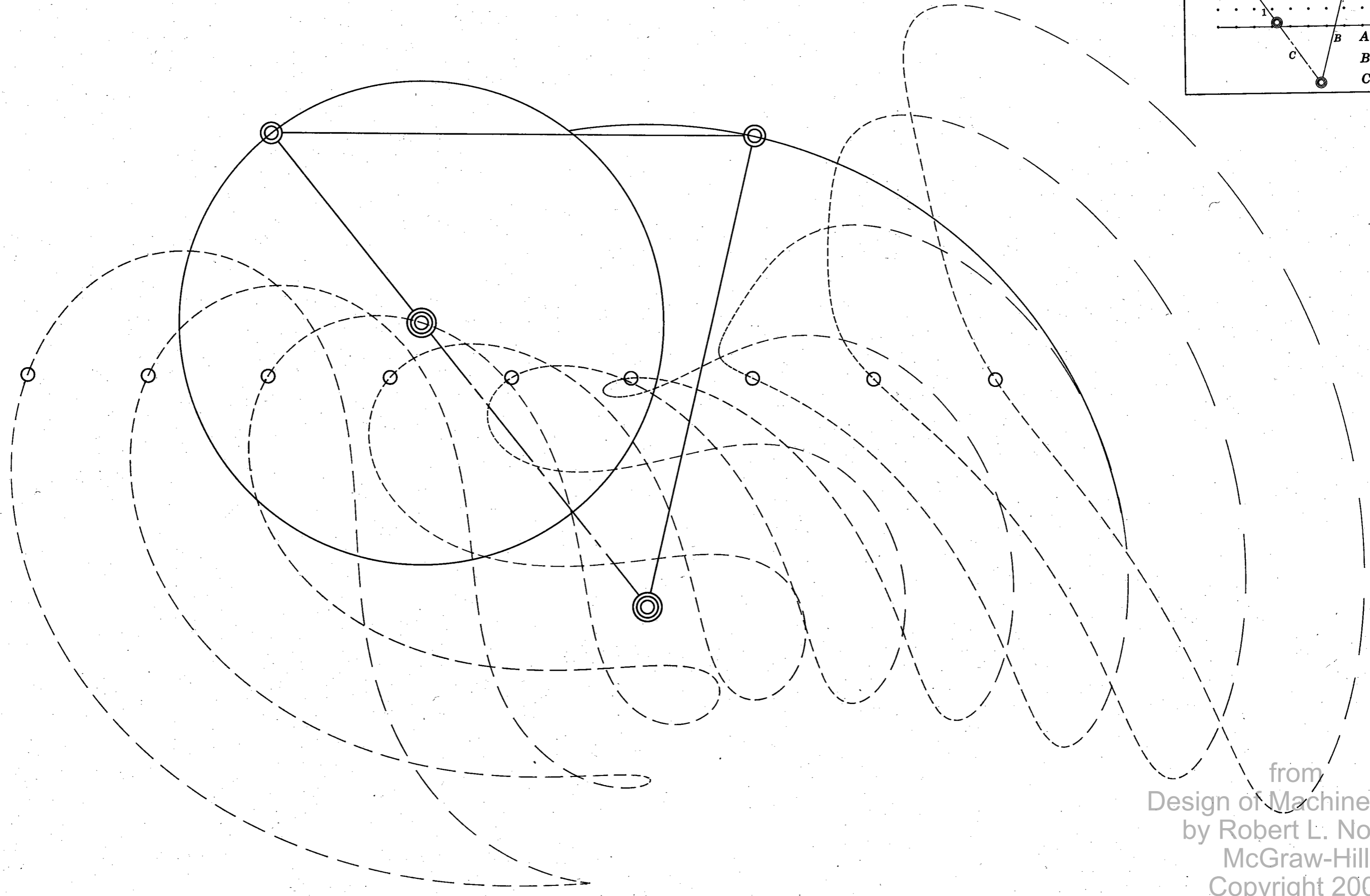
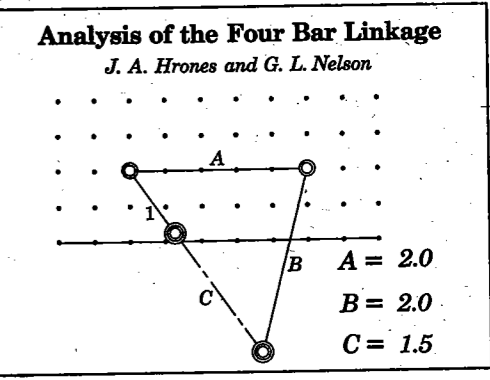

from  
Design of Machinery 4ed  
by Robert L. Norton  
McGraw-Hill  
Copyright 2008

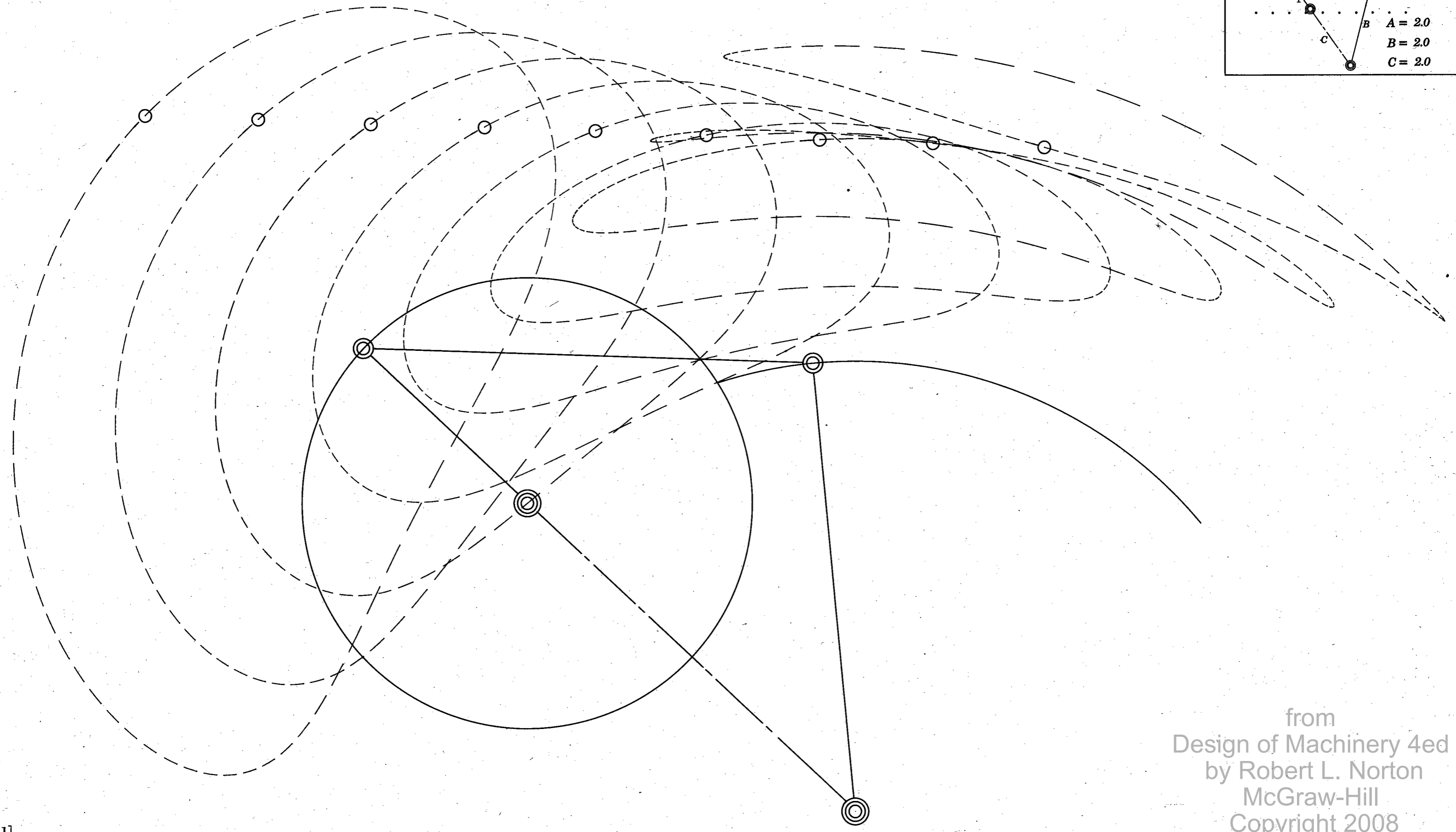
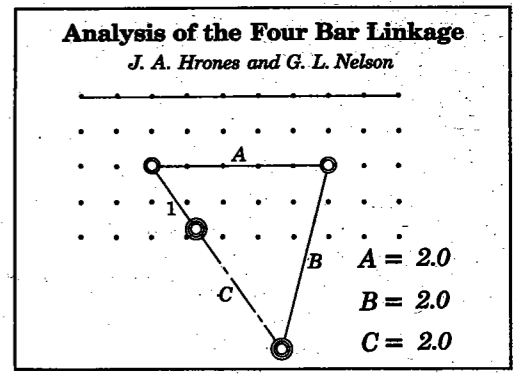

from  
 Design of Machinery 4ed  
 by Robert L. Norton  
 McGraw-Hill  
 Copyright 2008



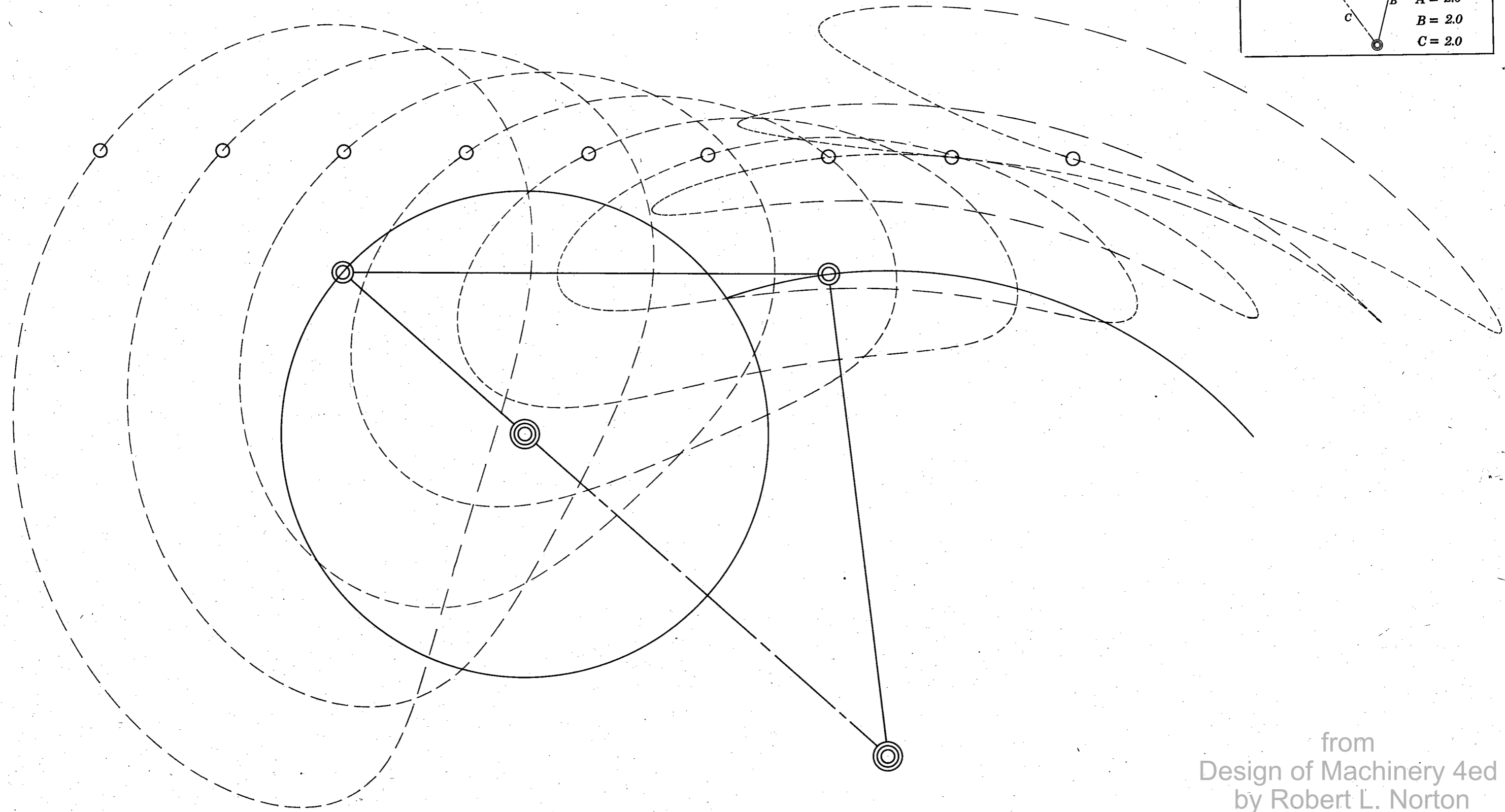
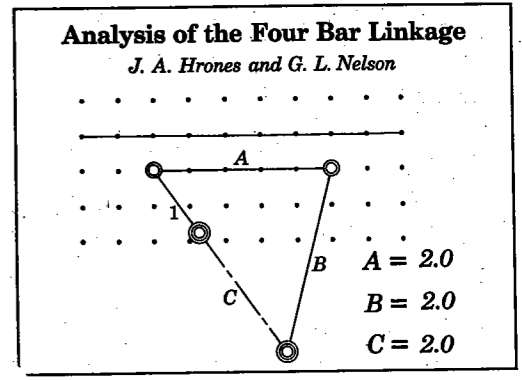

from  
Design of Machinery 4ed  
by Robert L. Norton  
McGraw-Hill  
Copyright 2008

**Analysis of the Four Bar Linkage**

*J. A. Hrones and G. L. Nelson*

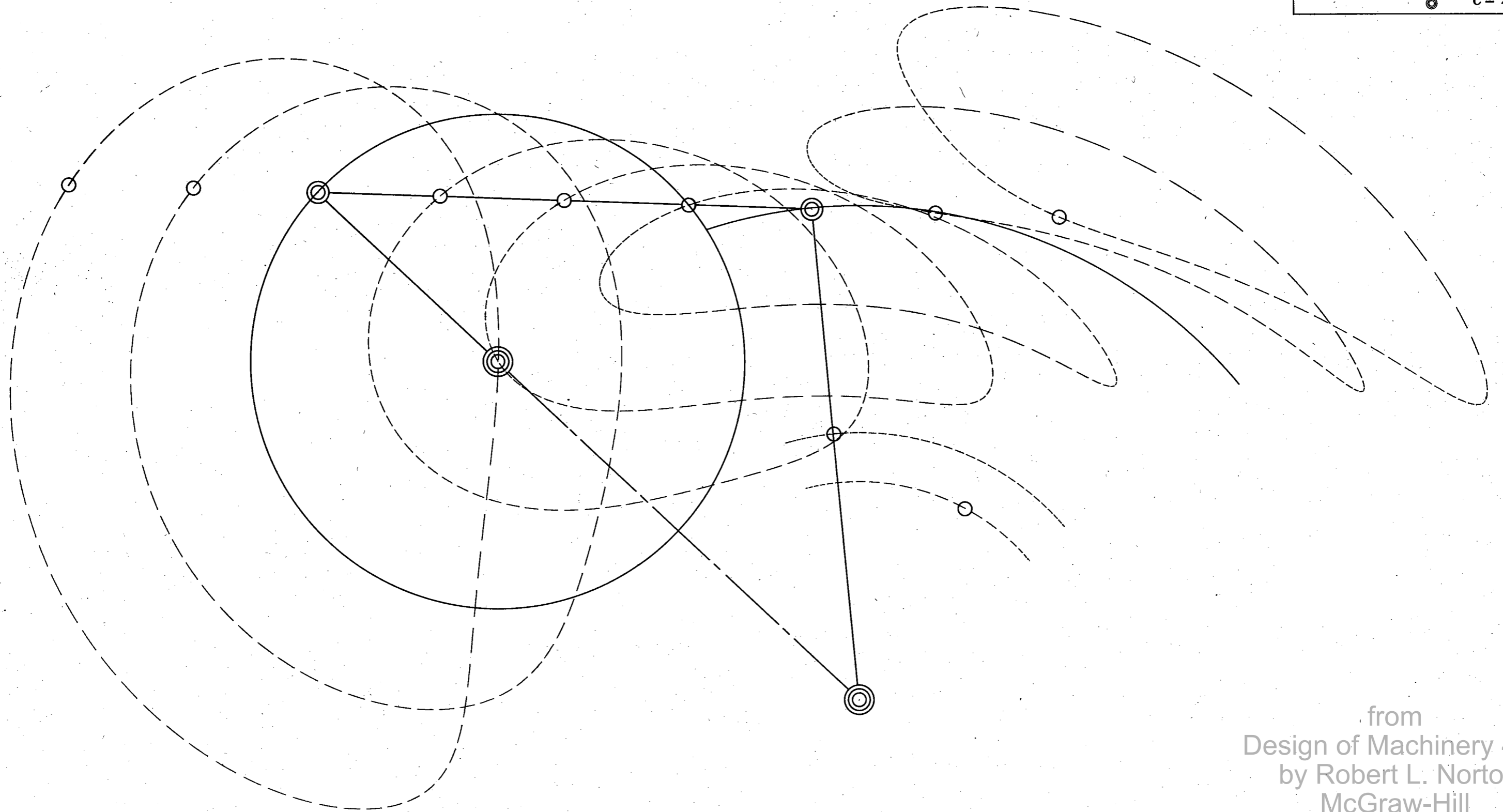
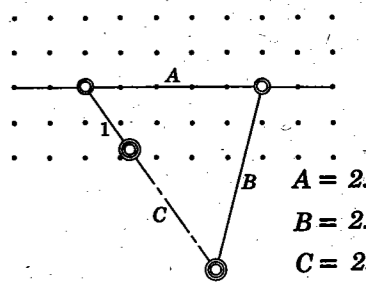

from  
Design of Machinery 4ed  
by Robert L. Norton  
McGraw-Hill  
Copyright 2008

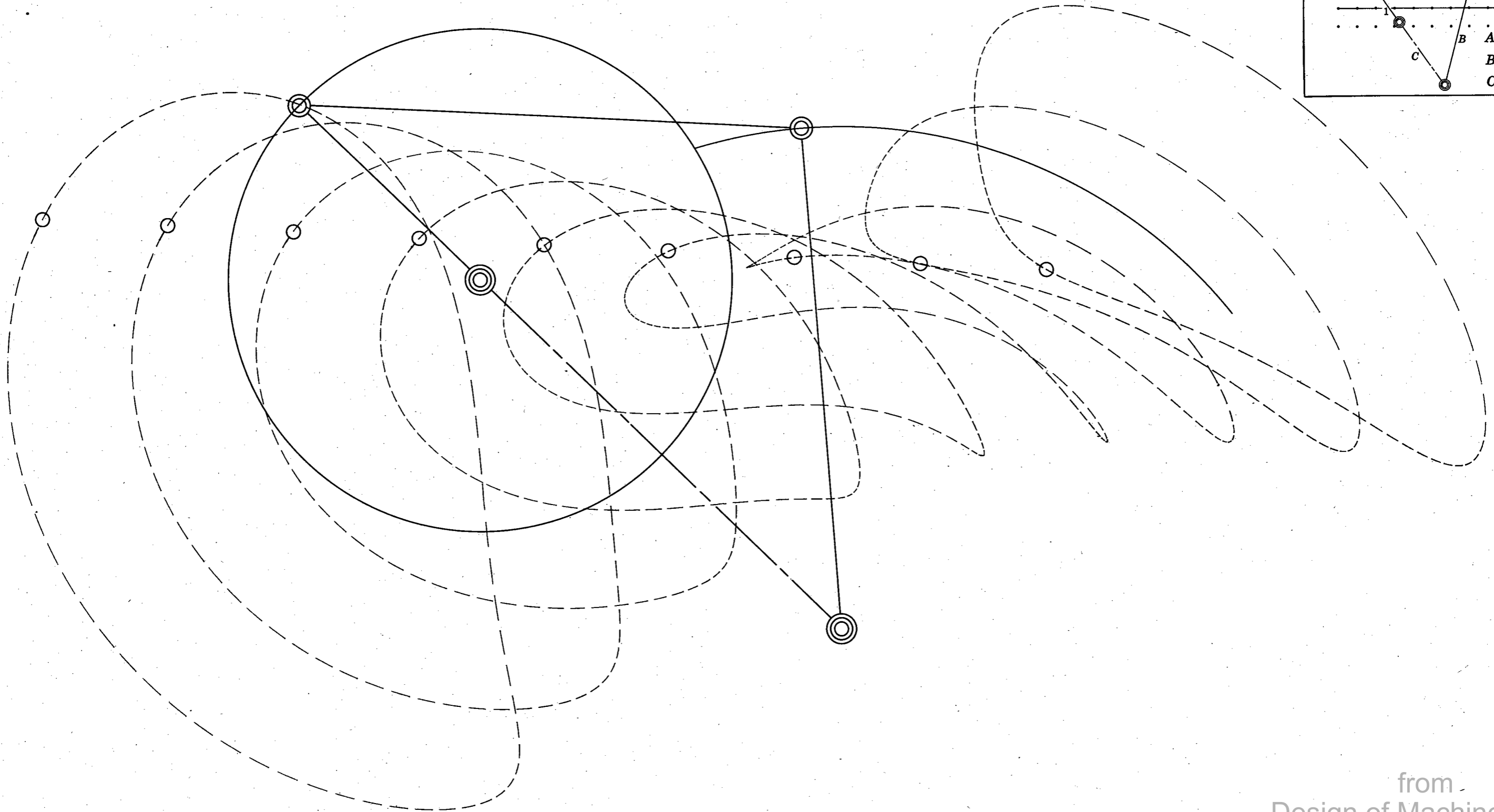
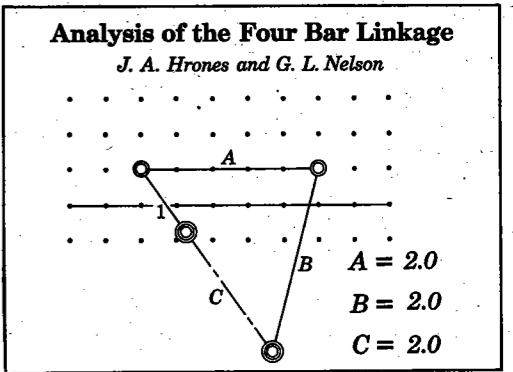

from  
Design of Machinery 4ed  
by Robert L. Norton  
McGraw-Hill  
Copyright 2008

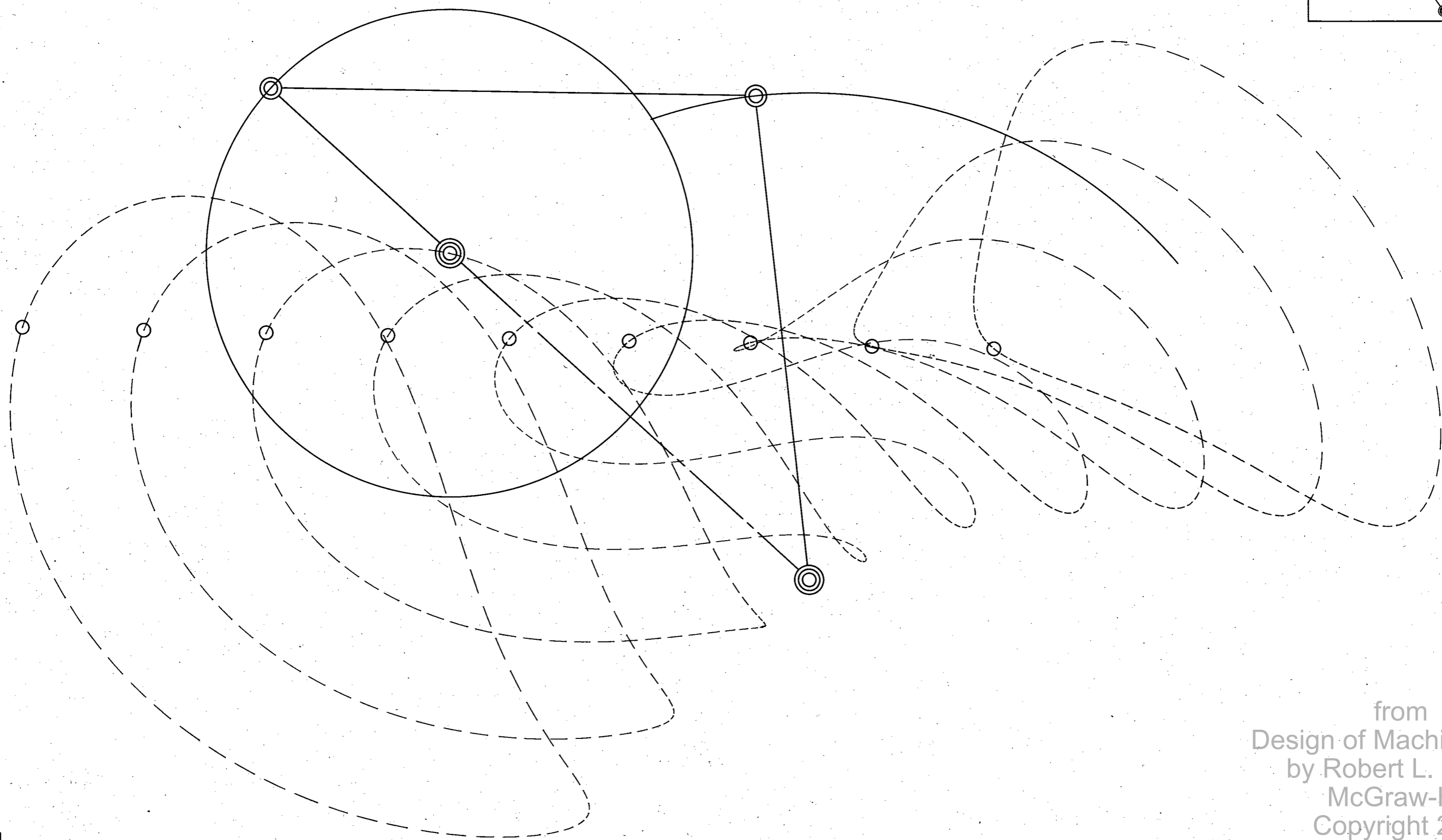
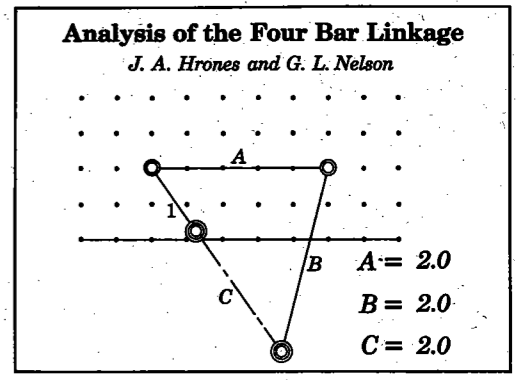

from  
 Design of Machinery 4ed  
 by Robert L. Norton  
 McGraw-Hill  
 Copyright 2008

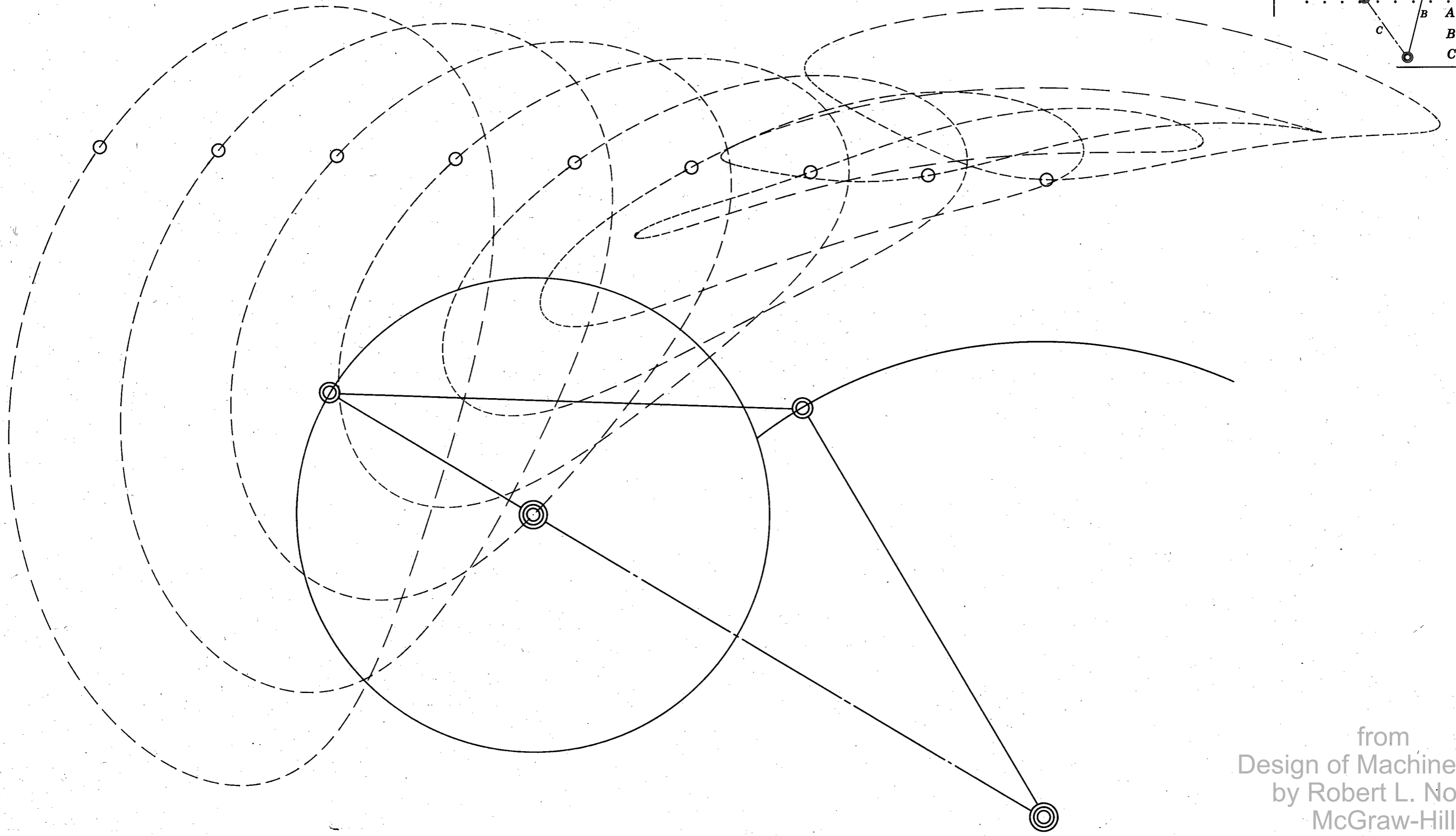
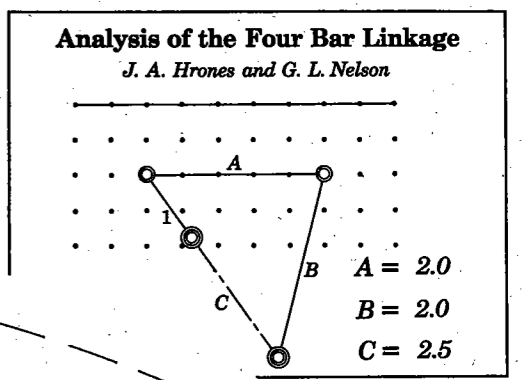

from  
Design of Machinery 4ed  
by Robert L. Norton  
McGraw-Hill  
Copyright 2008

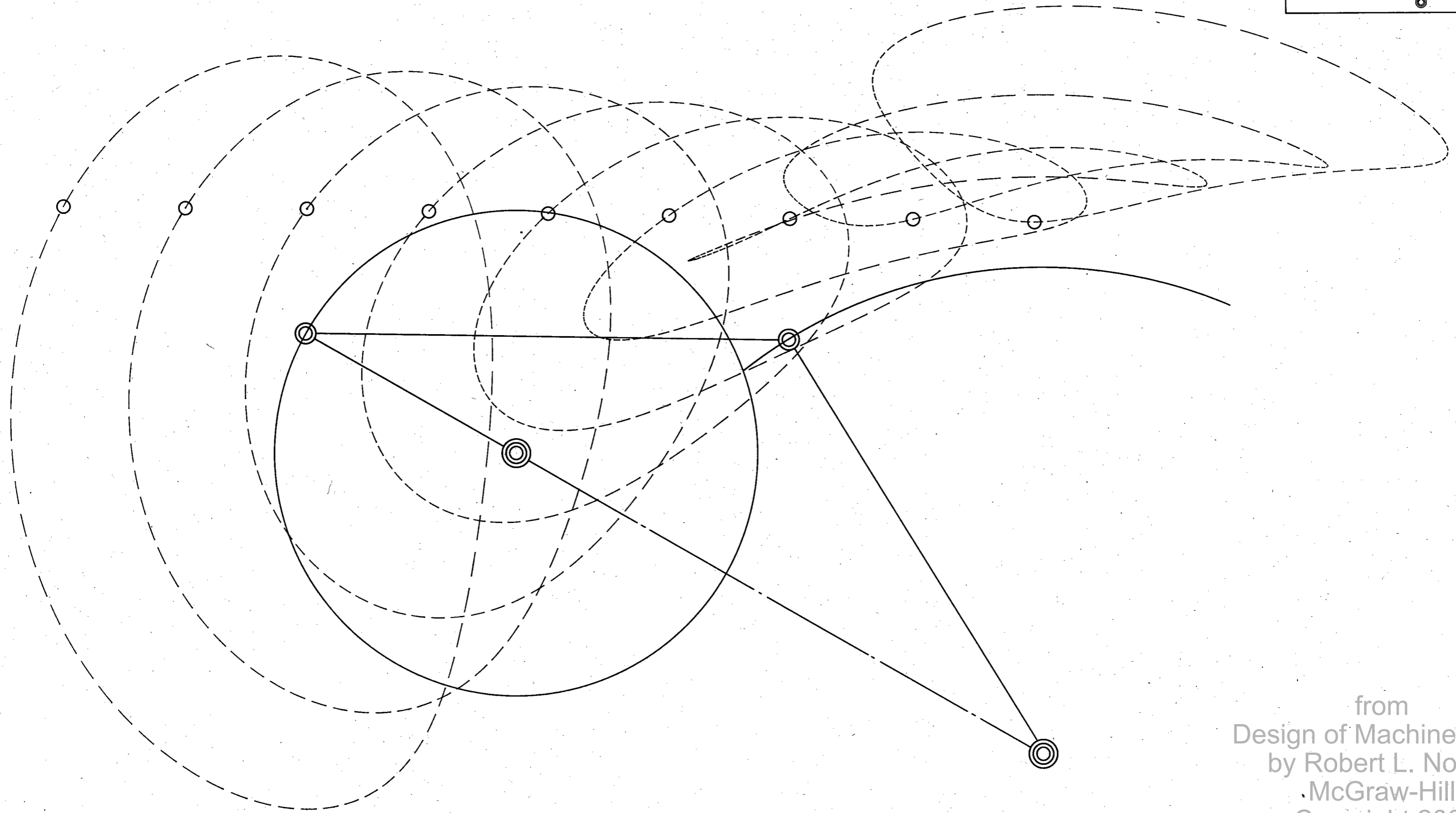
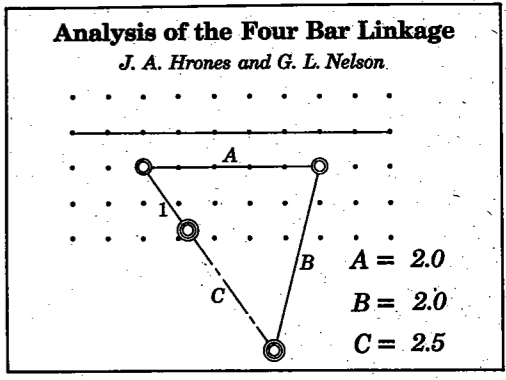

from  
 Design of Machinery 4ed  
 by Robert L. Norton  
 McGraw-Hill  
 Copyright 2008

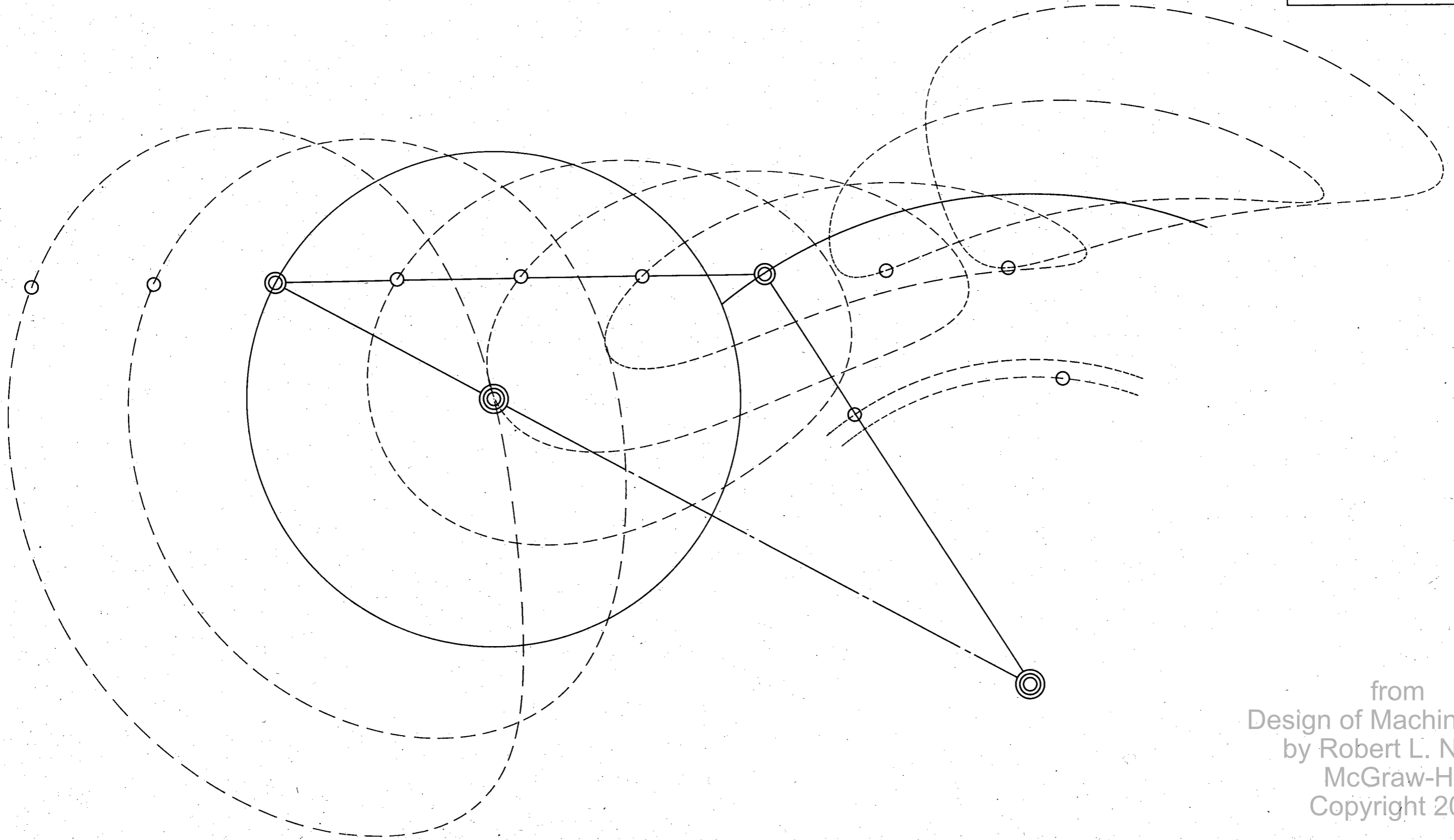
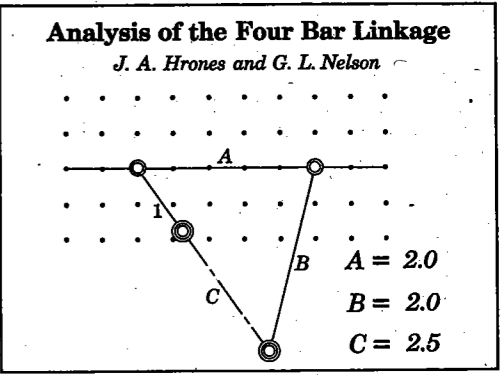

from  
Design of Machinery 4ed  
by Robert L. Norton  
McGraw-Hill  
Copyright 2008

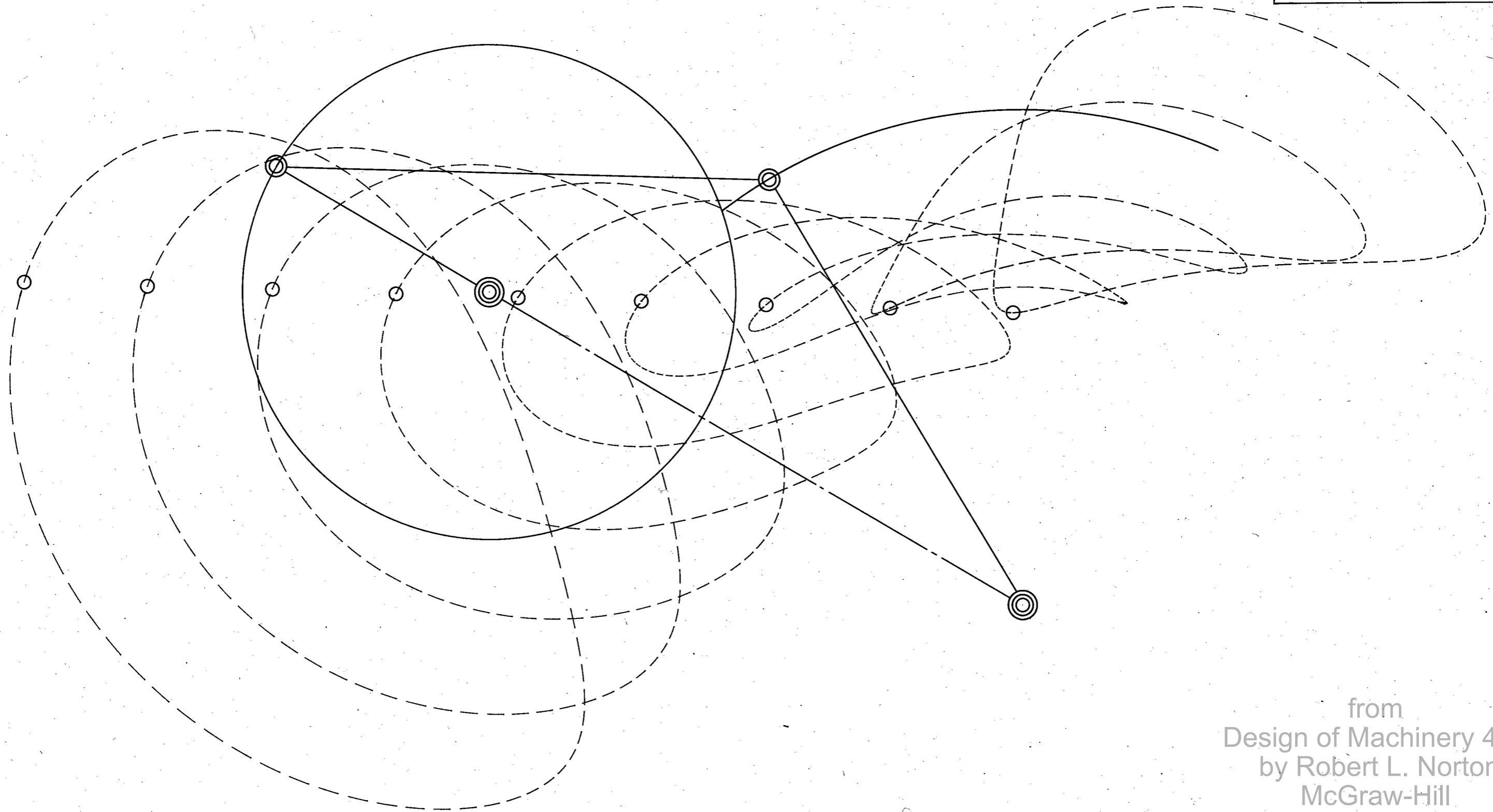
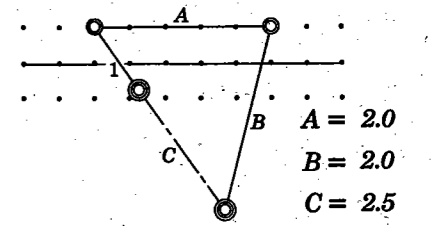

from  
Design of Machinery 4ed  
by Robert L. Norton  
McGraw-Hill  
Copyright 2008



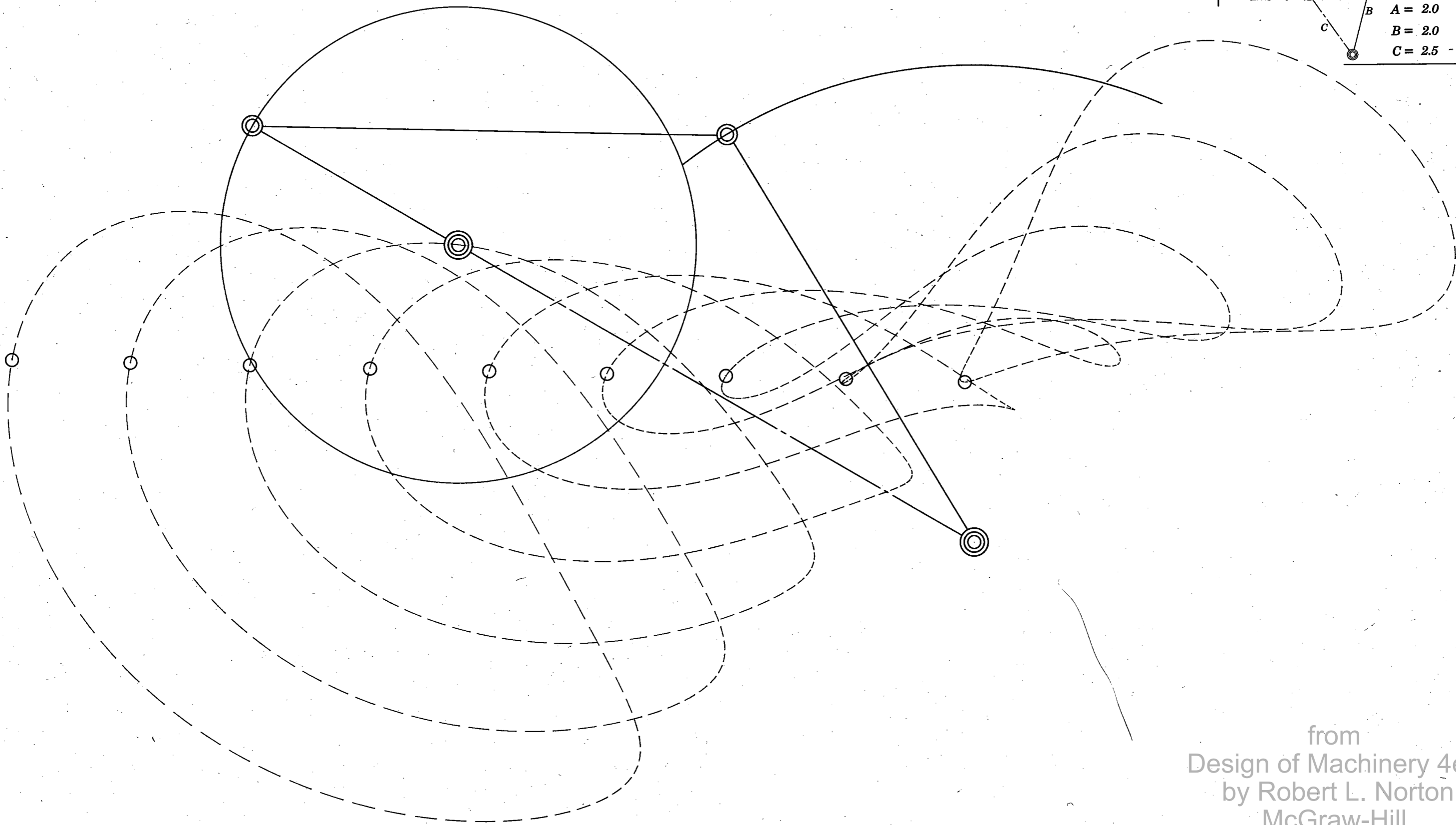
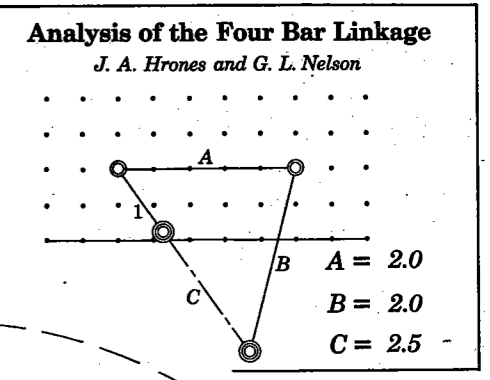

from  
Design of Machinery 4ed  
by Robert L. Norton  
McGraw-Hill  
Copyright 2008

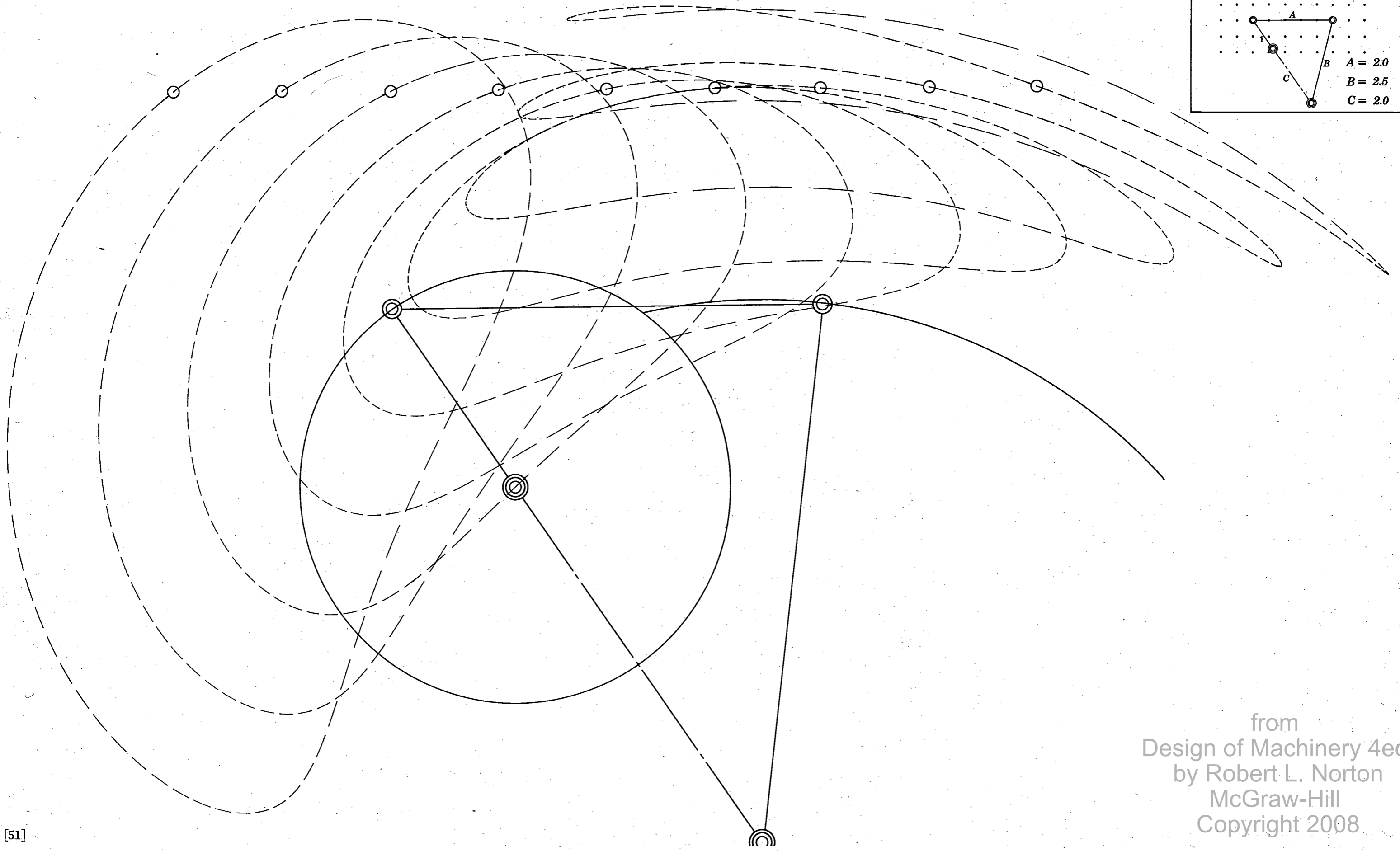
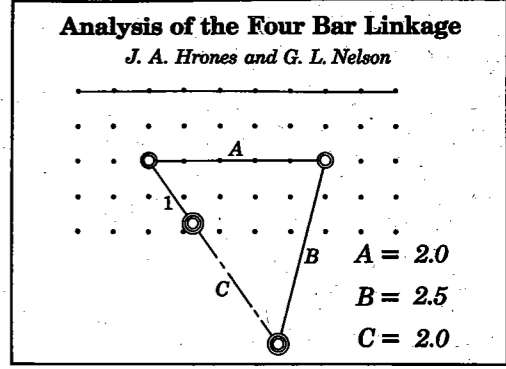

from  
 Design of Machinery 4ed  
 by Robert L. Norton  
 McGraw-Hill  
 Copyright 2008

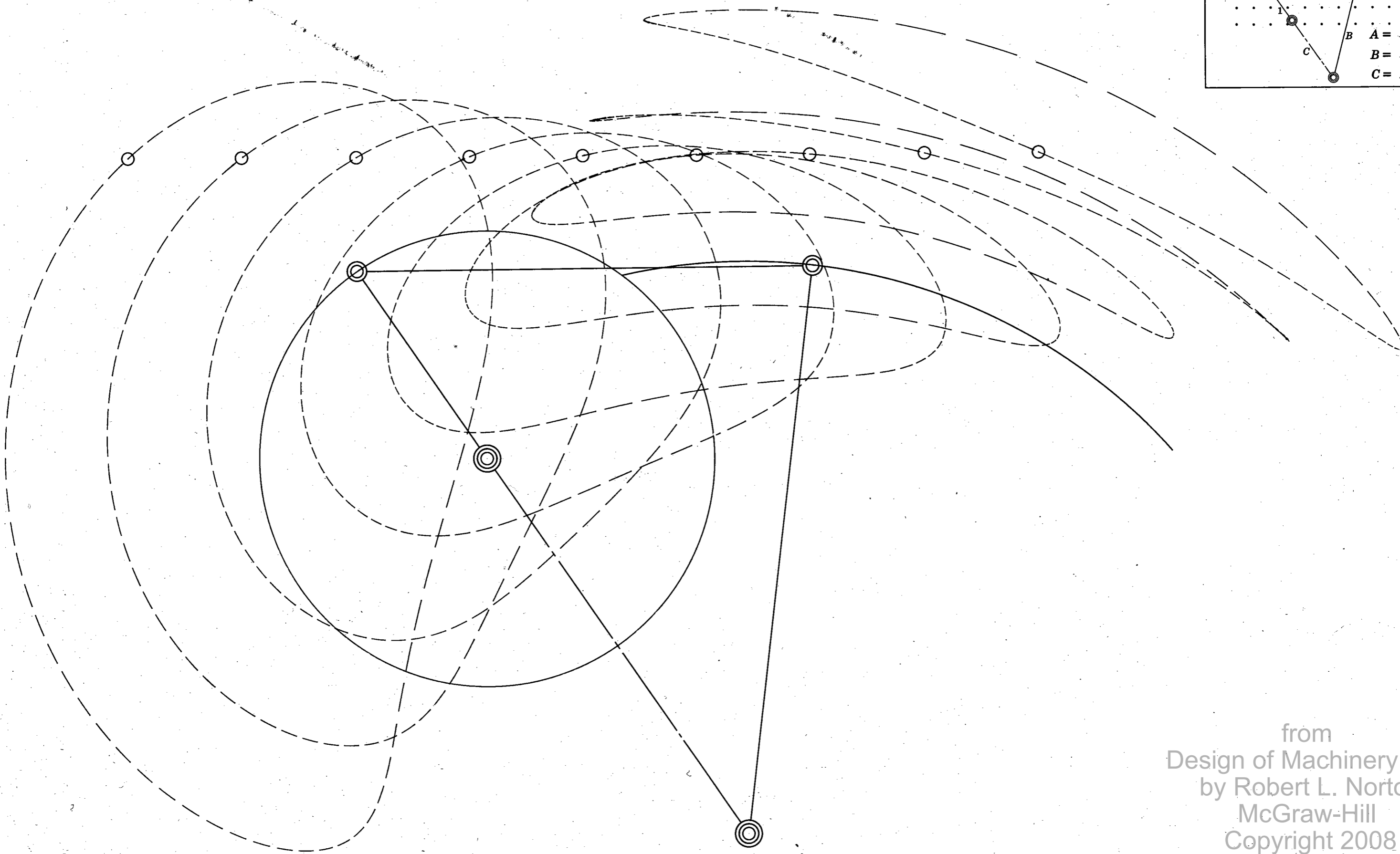
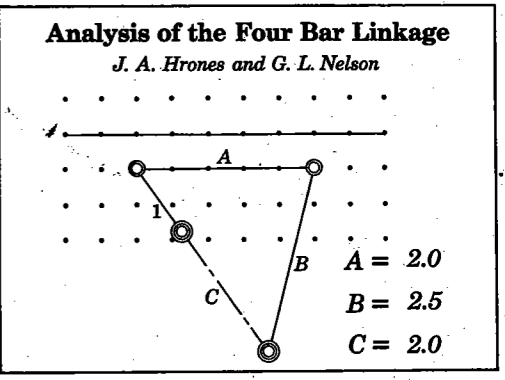

from  
Design of Machinery 4ed  
by Robert L. Norton  
McGraw-Hill  
Copyright 2008

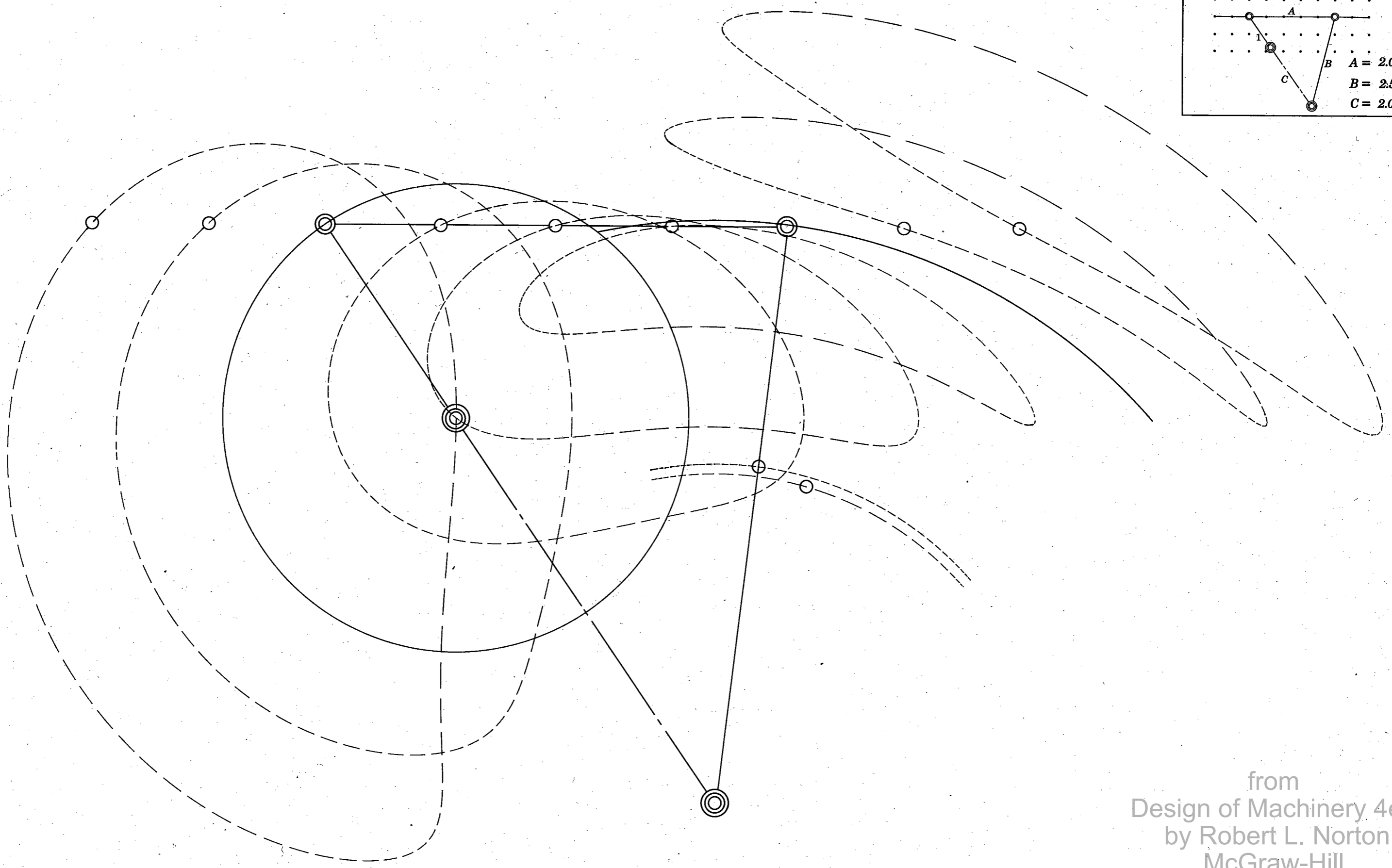
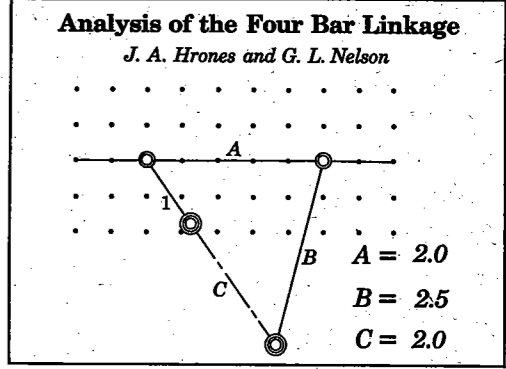

from  
 Design of Machinery 4ed  
 by Robert L. Norton  
 McGraw-Hill  
 Copyright 2008

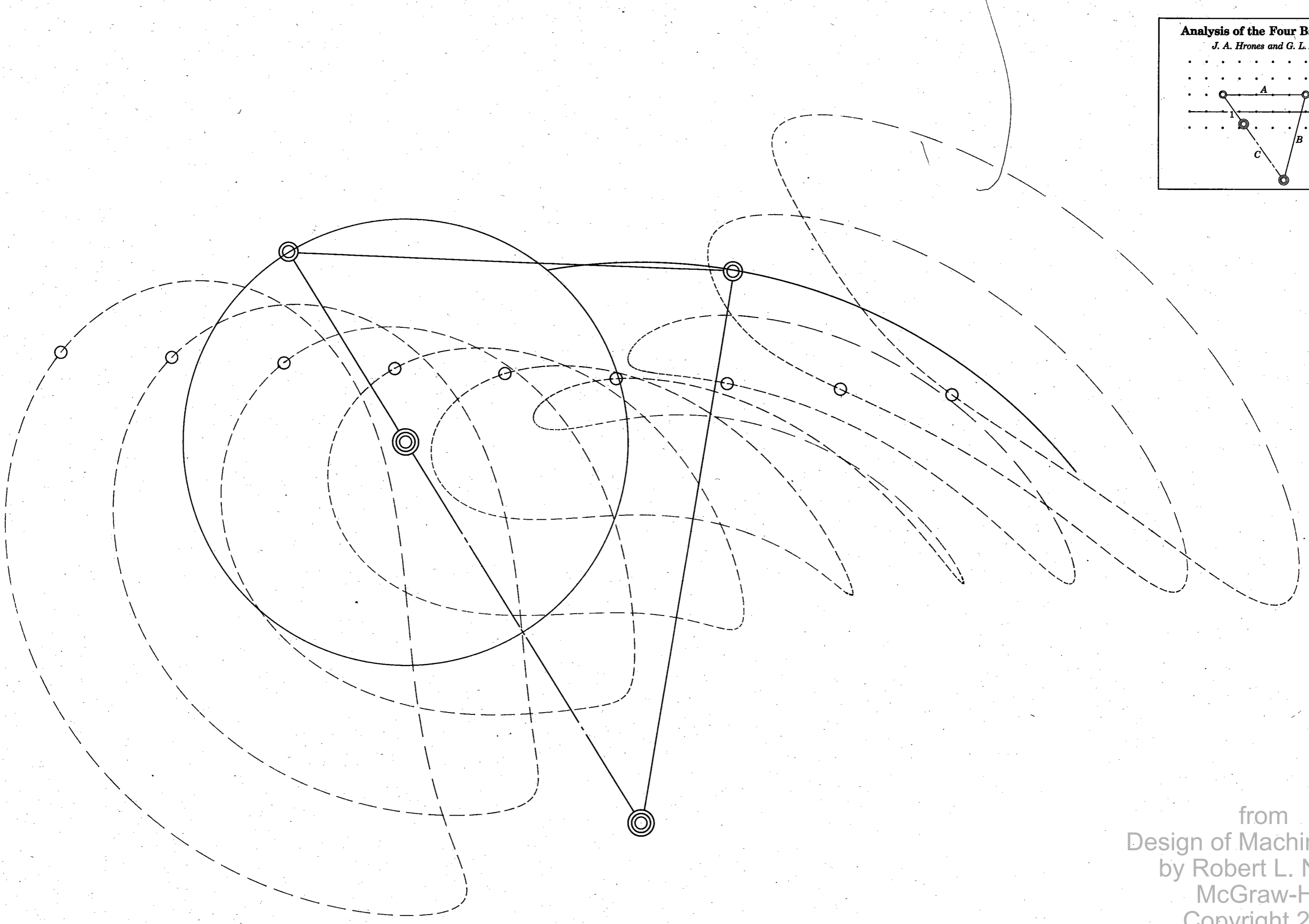
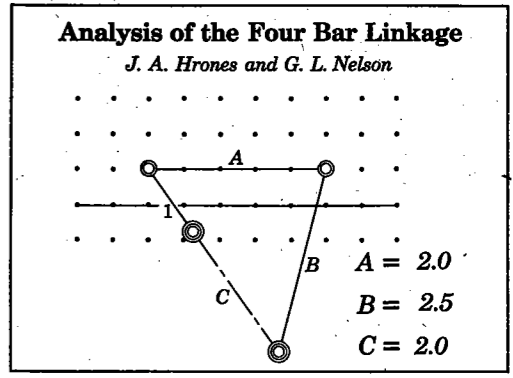

from  
Design of Machinery 4ed  
by Robert L. Norton  
McGraw-Hill  
Copyright 2008

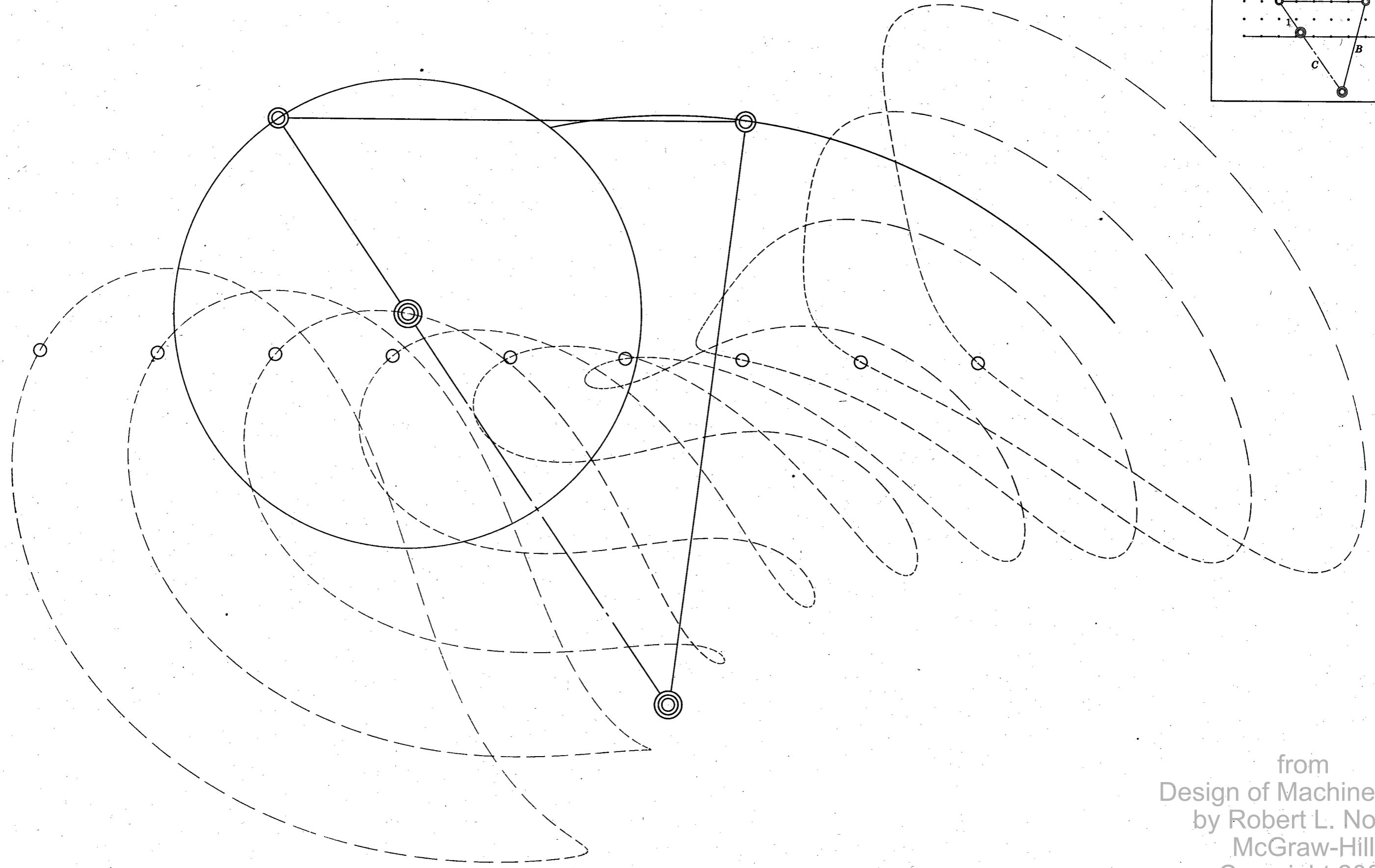
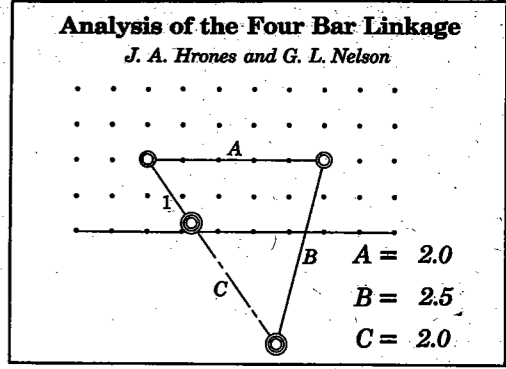

from  
 Design of Machinery 4ed  
 by Robert L. Norton  
 McGraw-Hill  
 Copyright 2008

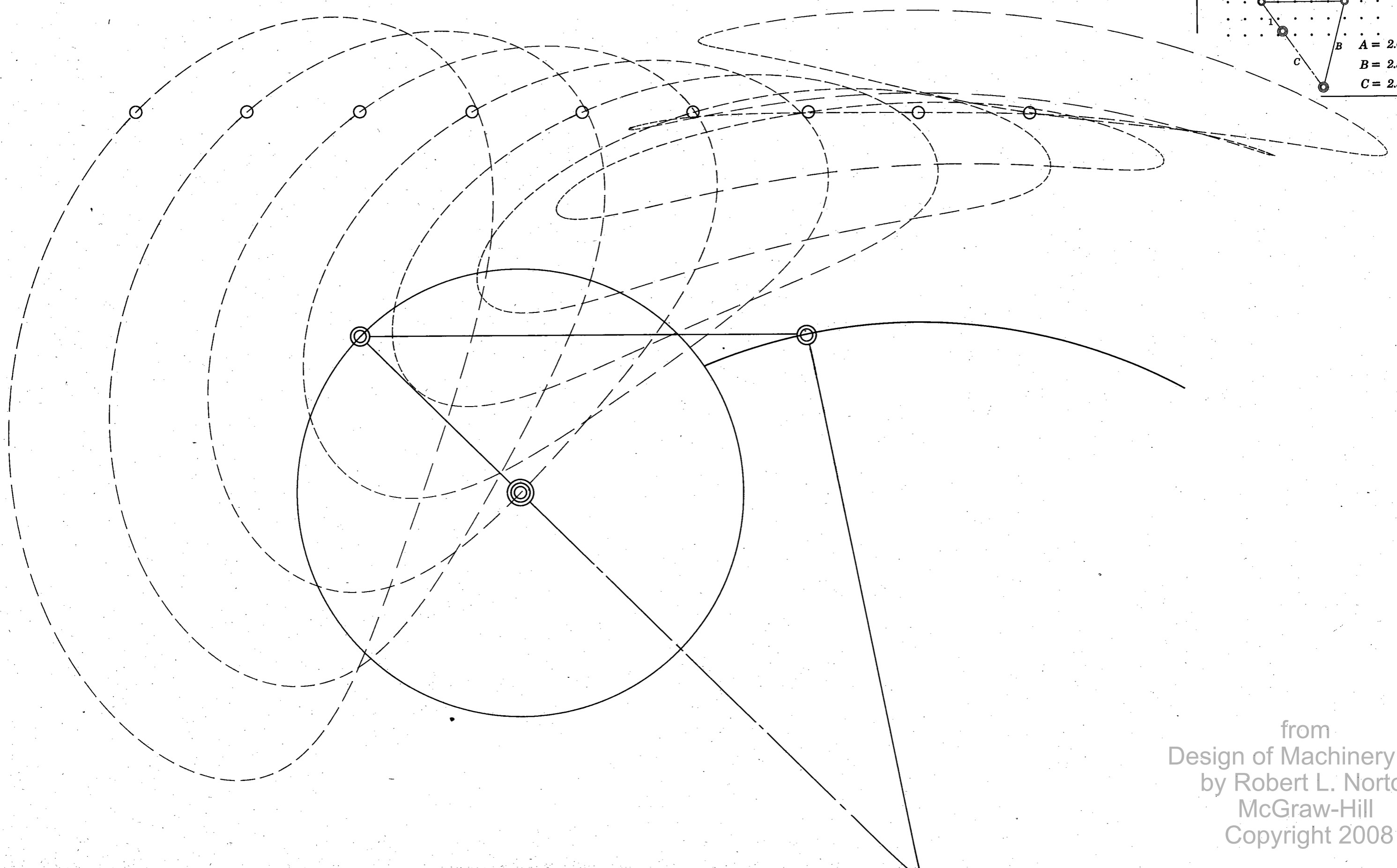
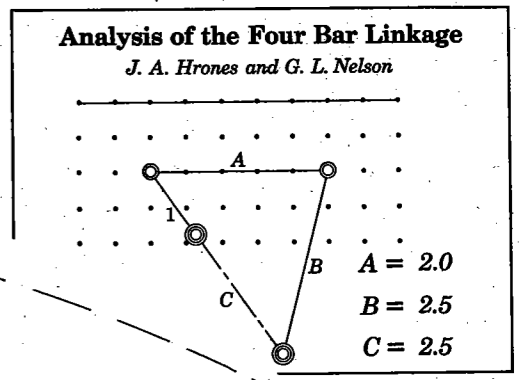

from  
Design of Machinery 4ed  
by Robert L. Norton  
McGraw-Hill  
Copyright 2008

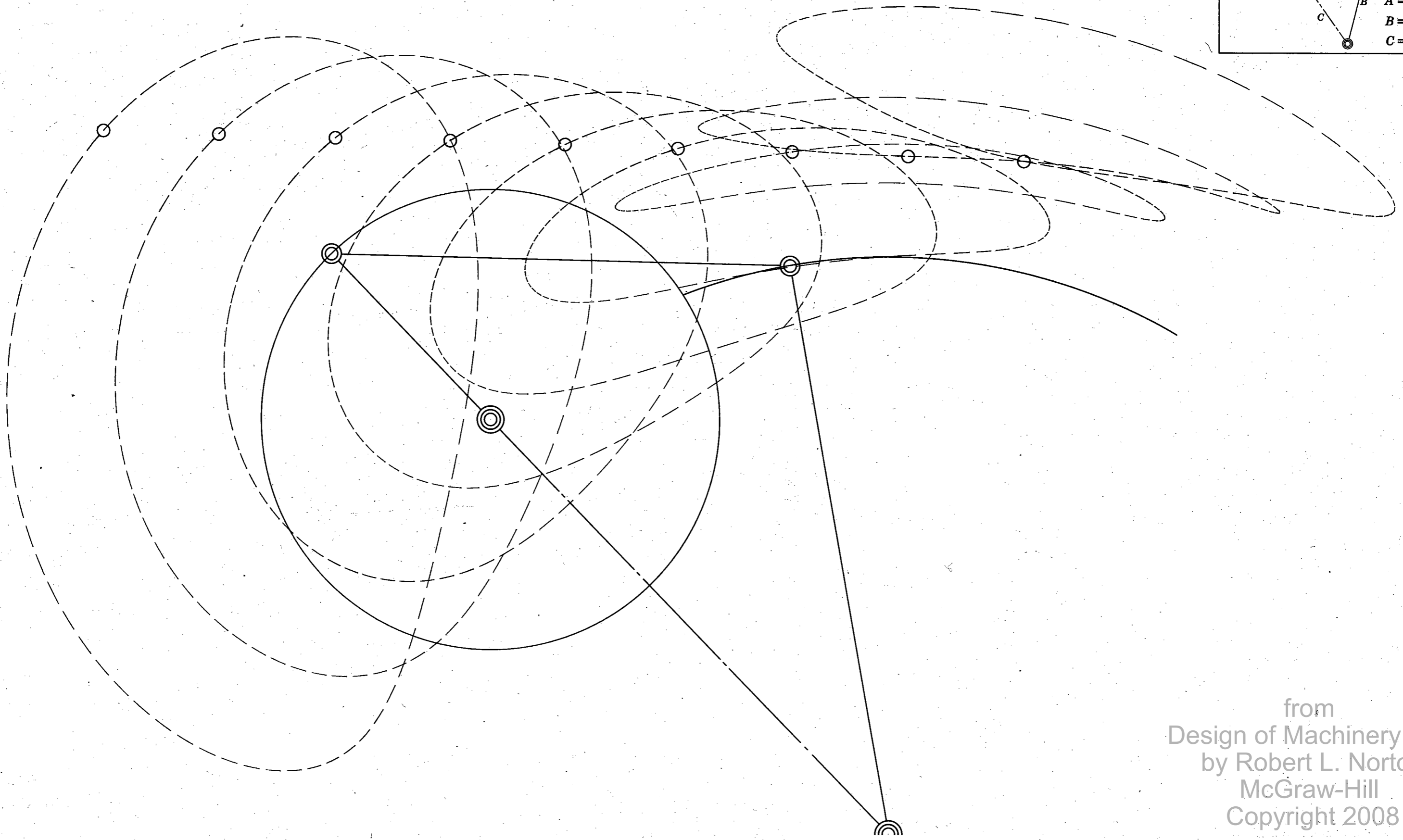
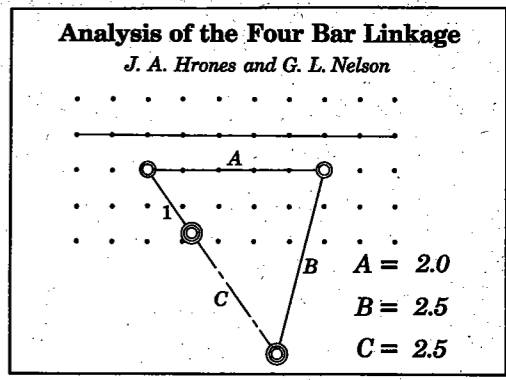

from  
 Design of Machinery 4ed  
 by Robert L. Norton  
 McGraw-Hill  
 Copyright 2008



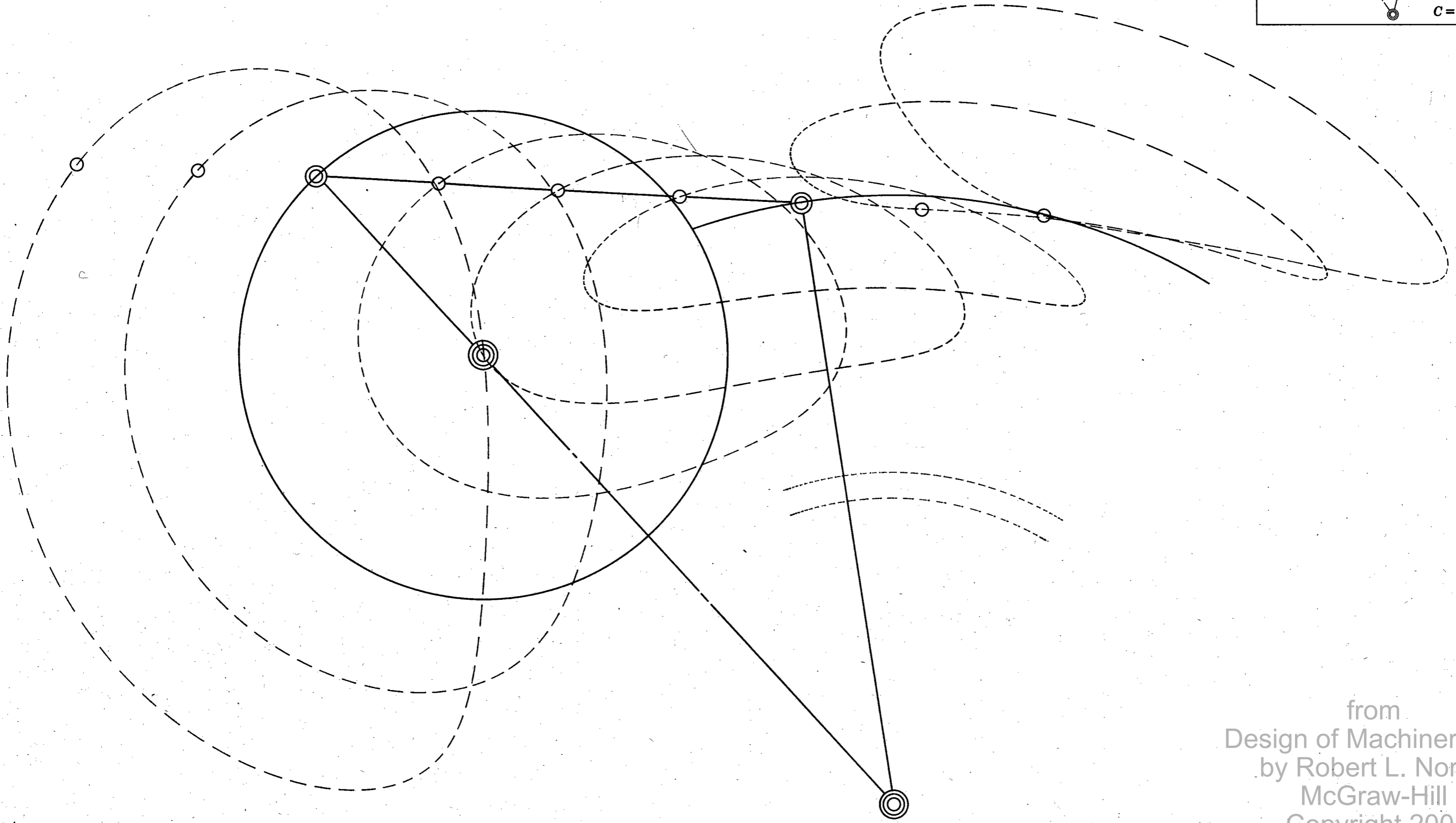
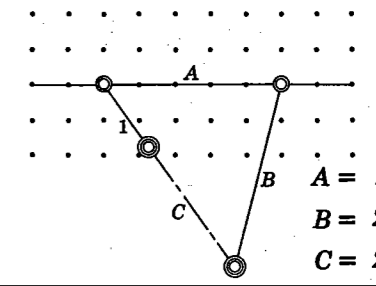

from  
Design of Machinery 4ed  
by Robert L. Norton  
McGraw-Hill  
Copyright 2008

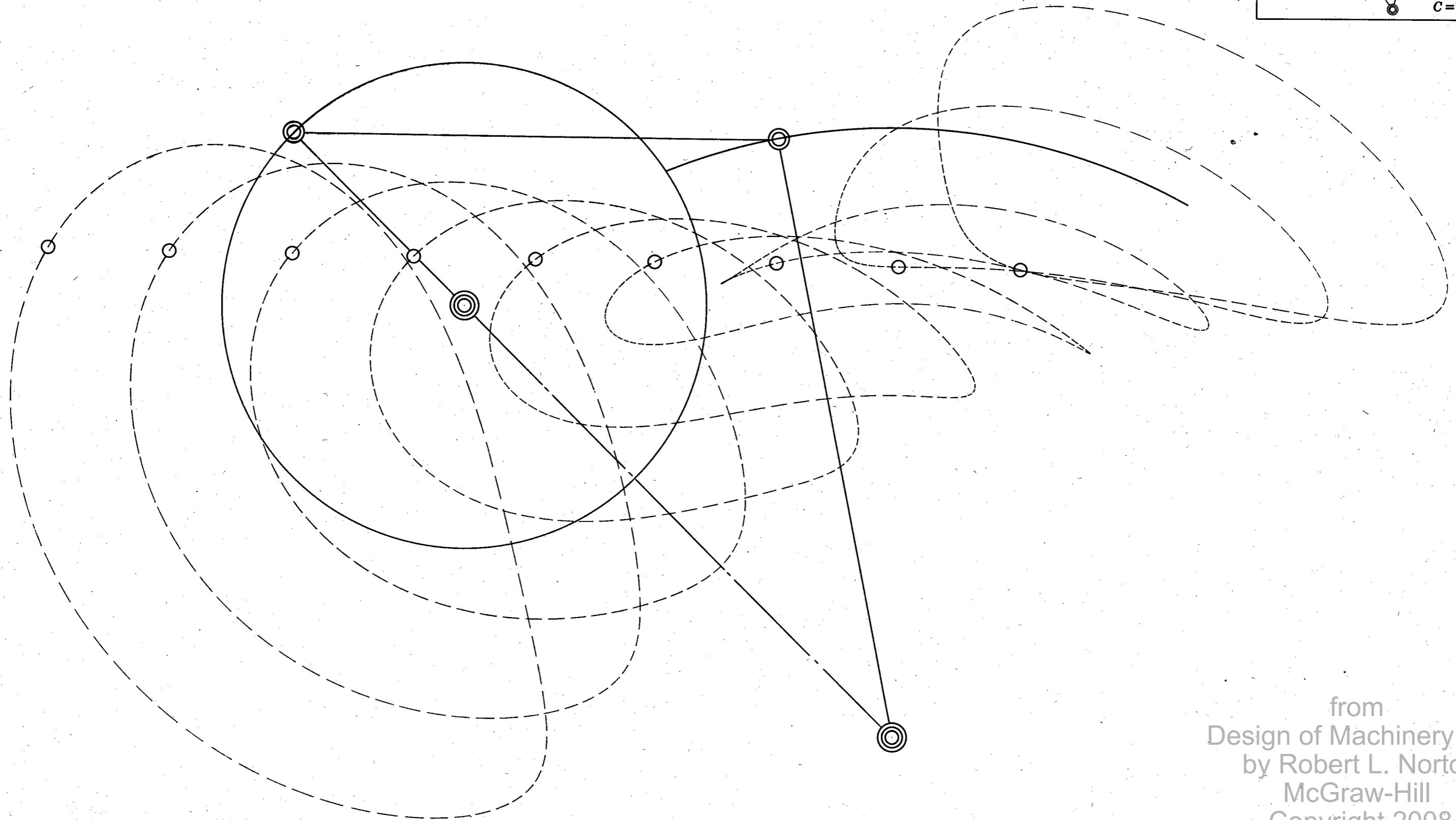
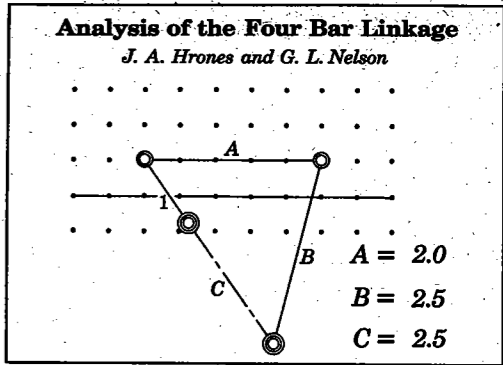

from  
 Design of Machinery 4ed  
 by Robert L. Norton  
 McGraw-Hill  
 Copyright 2008

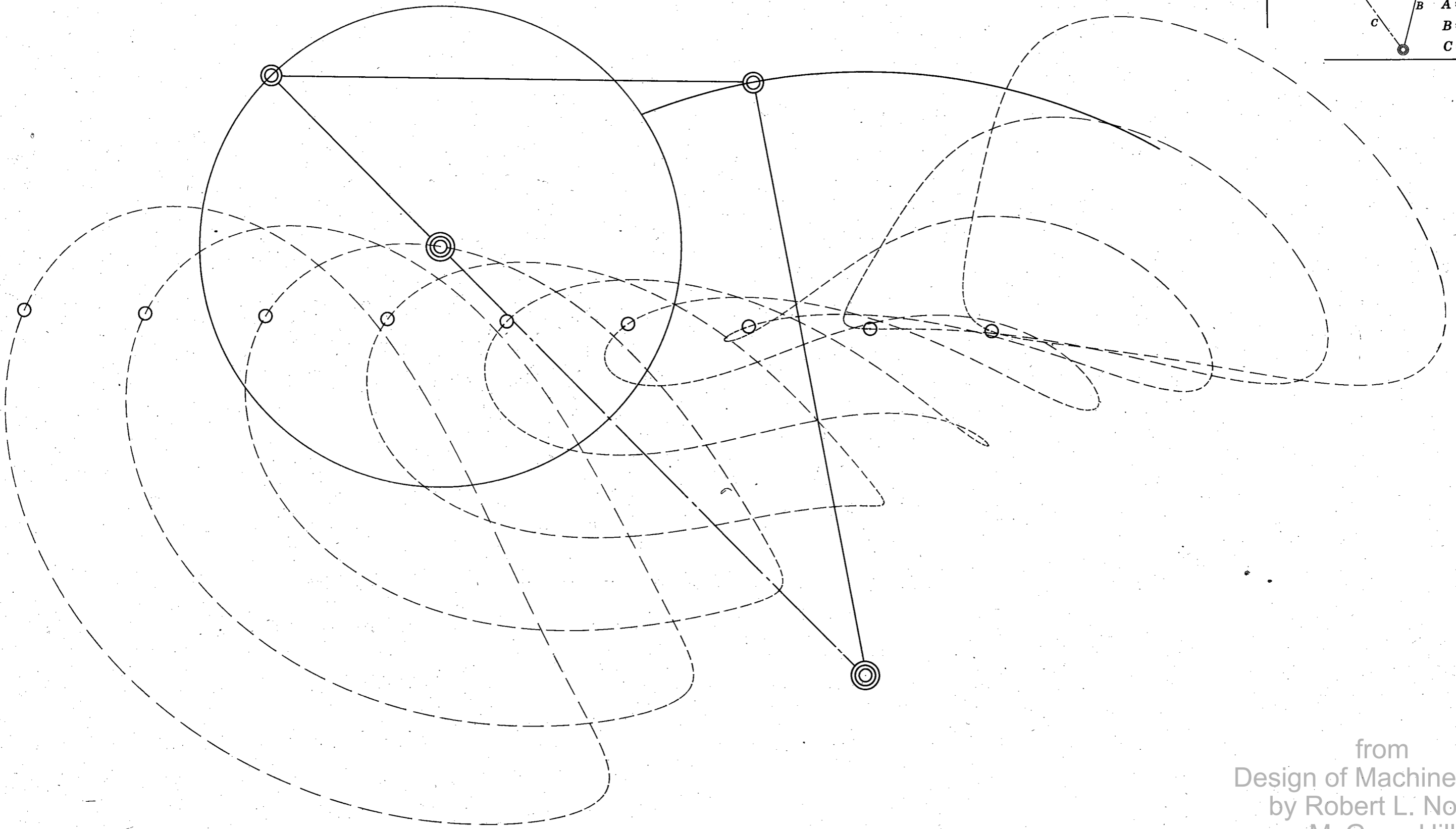
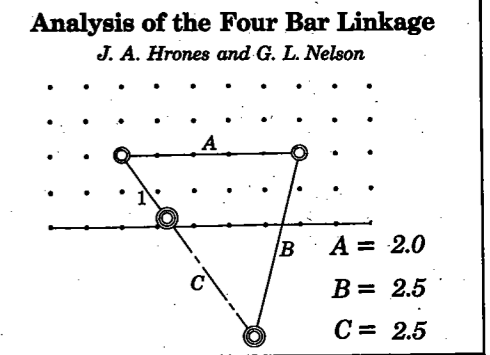

from  
Design of Machinery 4ed  
by Robert L. Norton  
McGraw-Hill  
Copyright 2008

**Analysis of the Four Bar Linkage**

*J. A. Hrones and G. L. Nelson*

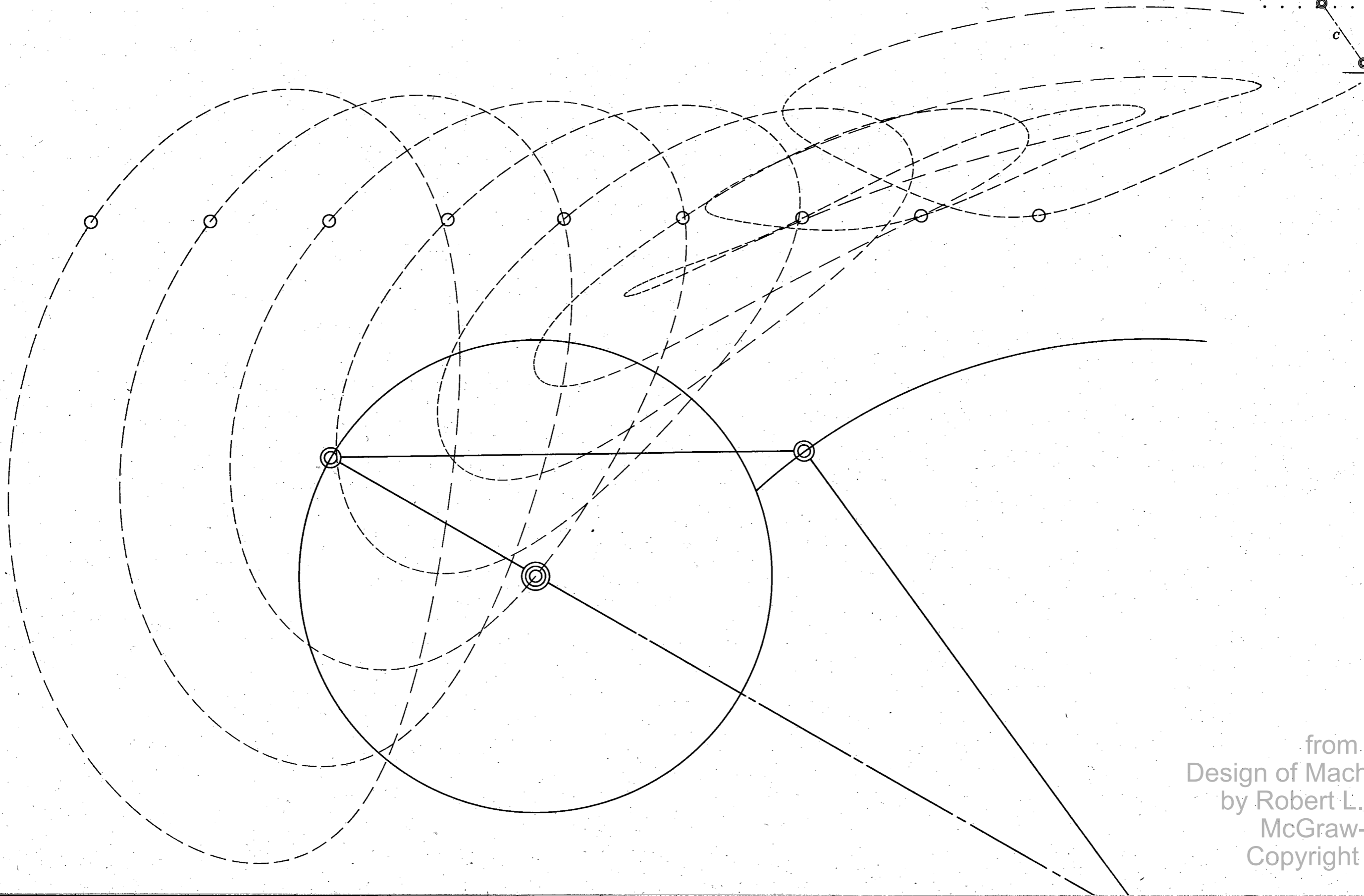
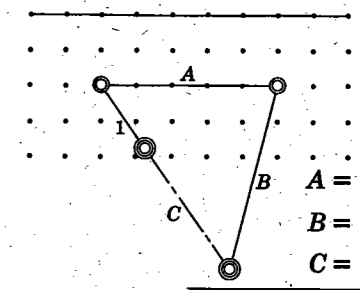

from  
Design of Machinery 4ed  
by Robert L. Norton  
McGraw-Hill  
Copyright 2008

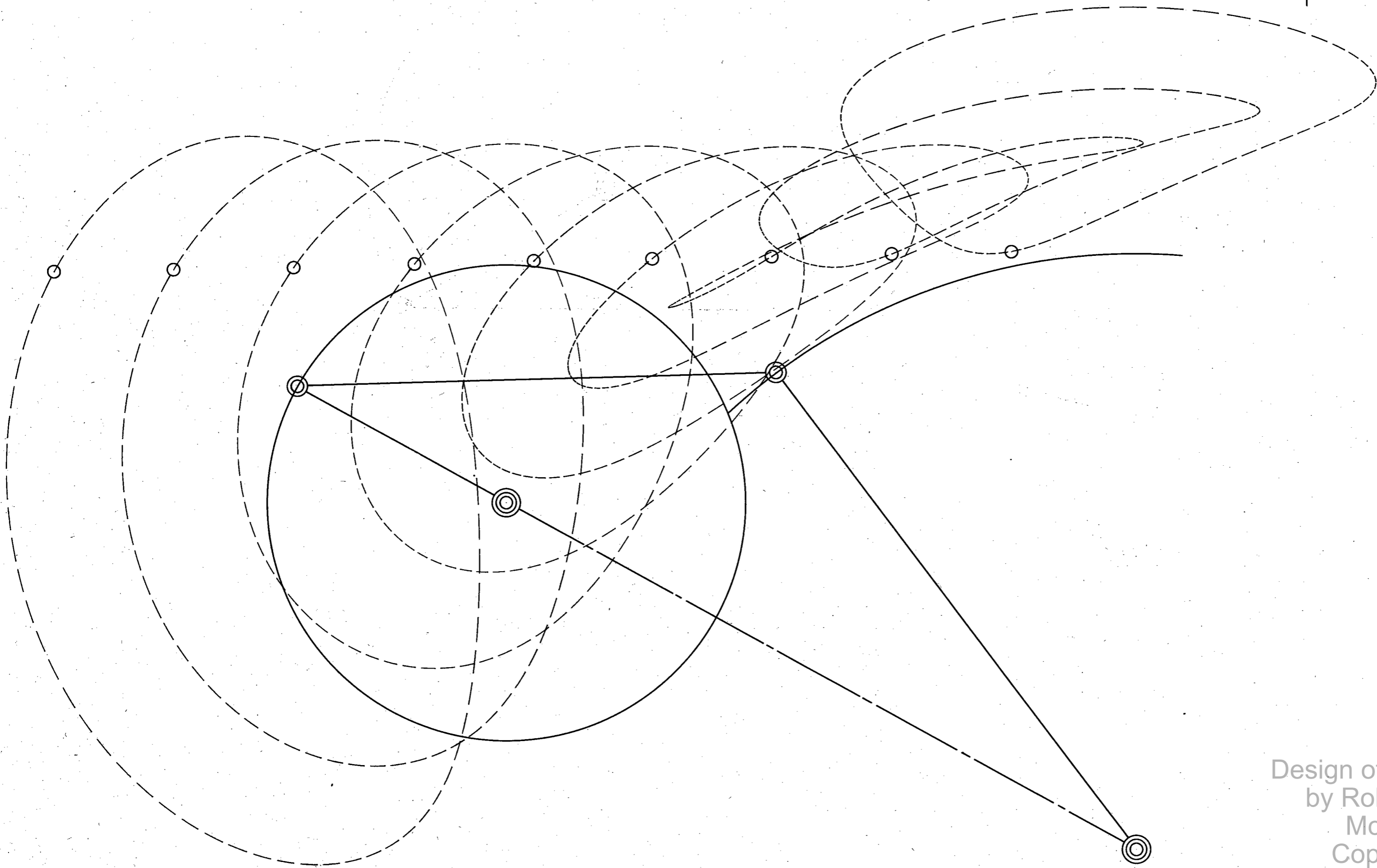
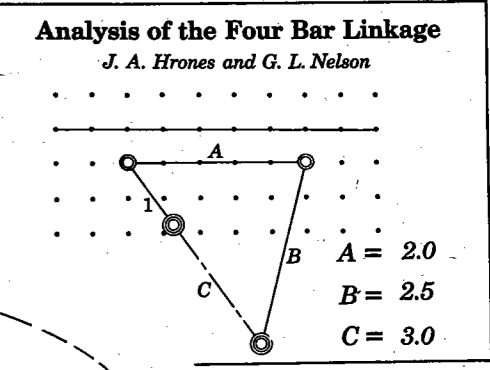

from  
Design of Machinery 4ed  
by Robert L. Norton  
McGraw-Hill  
Copyright 2008

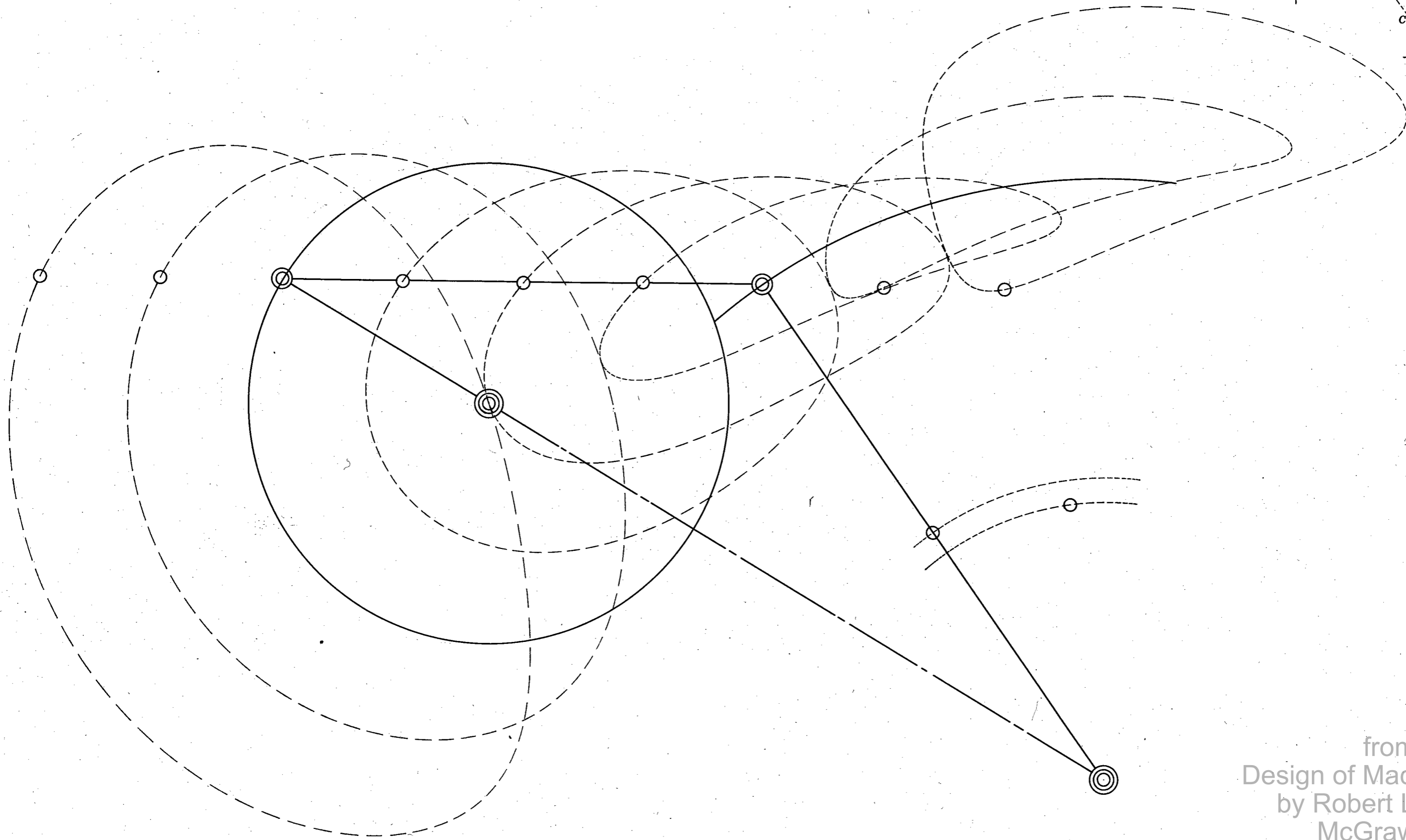
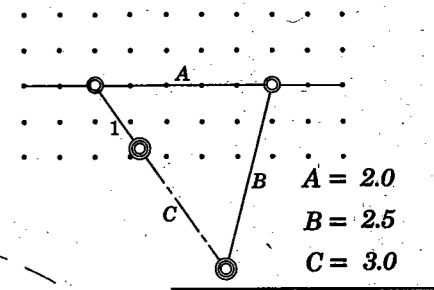

from  
Design of Machinery 4ed  
by Robert L. Norton  
McGraw-Hill  
Copyright 2008

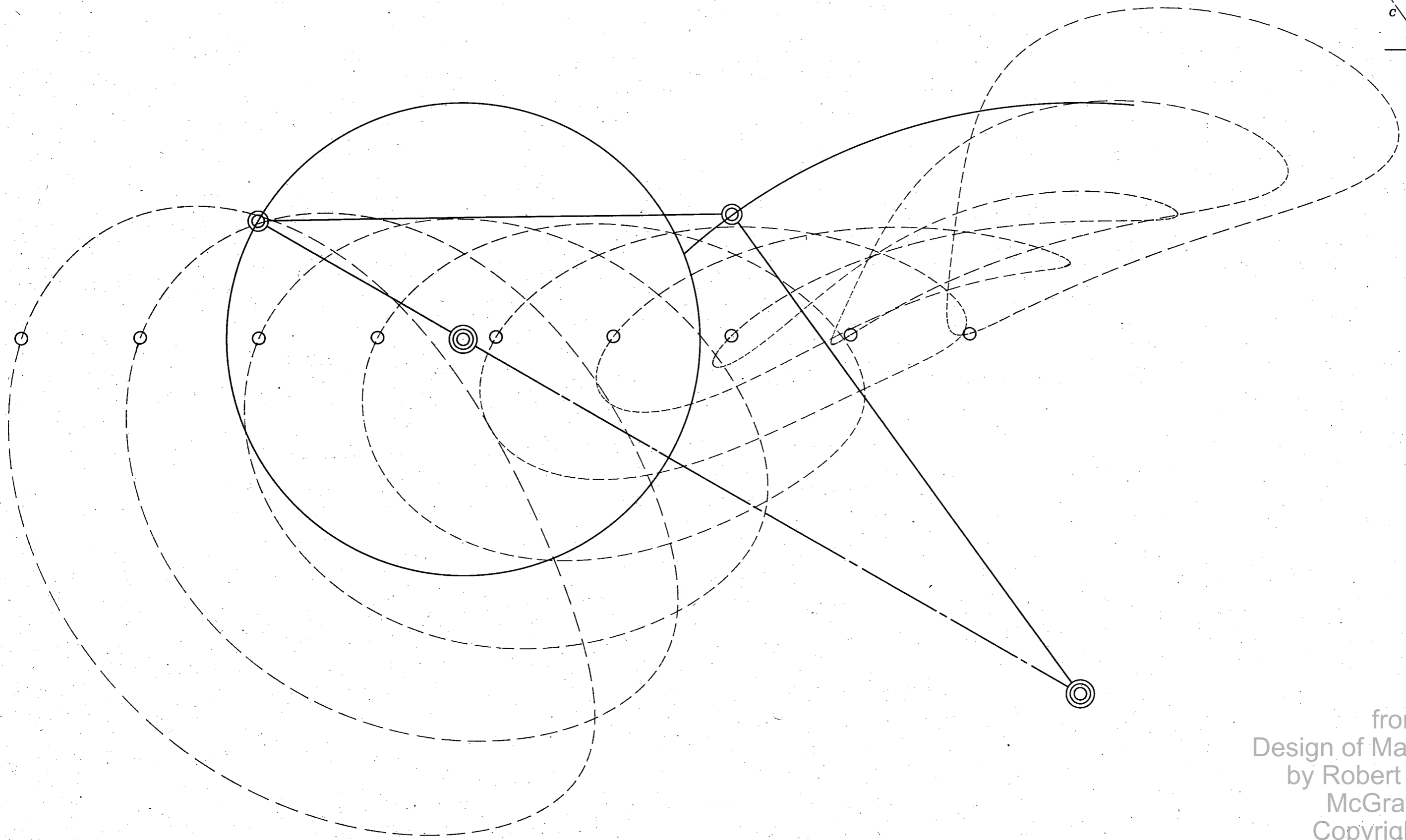
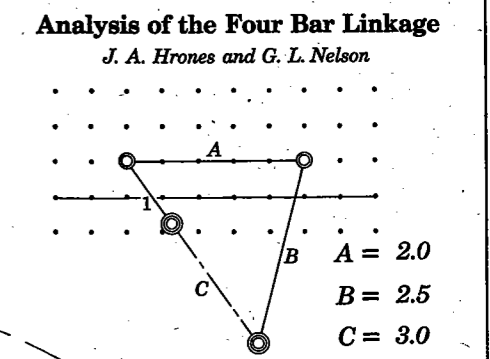

from  
Design of Machinery 4ed  
by Robert L. Norton  
McGraw-Hill  
Copyright 2008

**Analysis of the Four Bar Linkage**

*J. A. Hrones and G. L. Nelson*

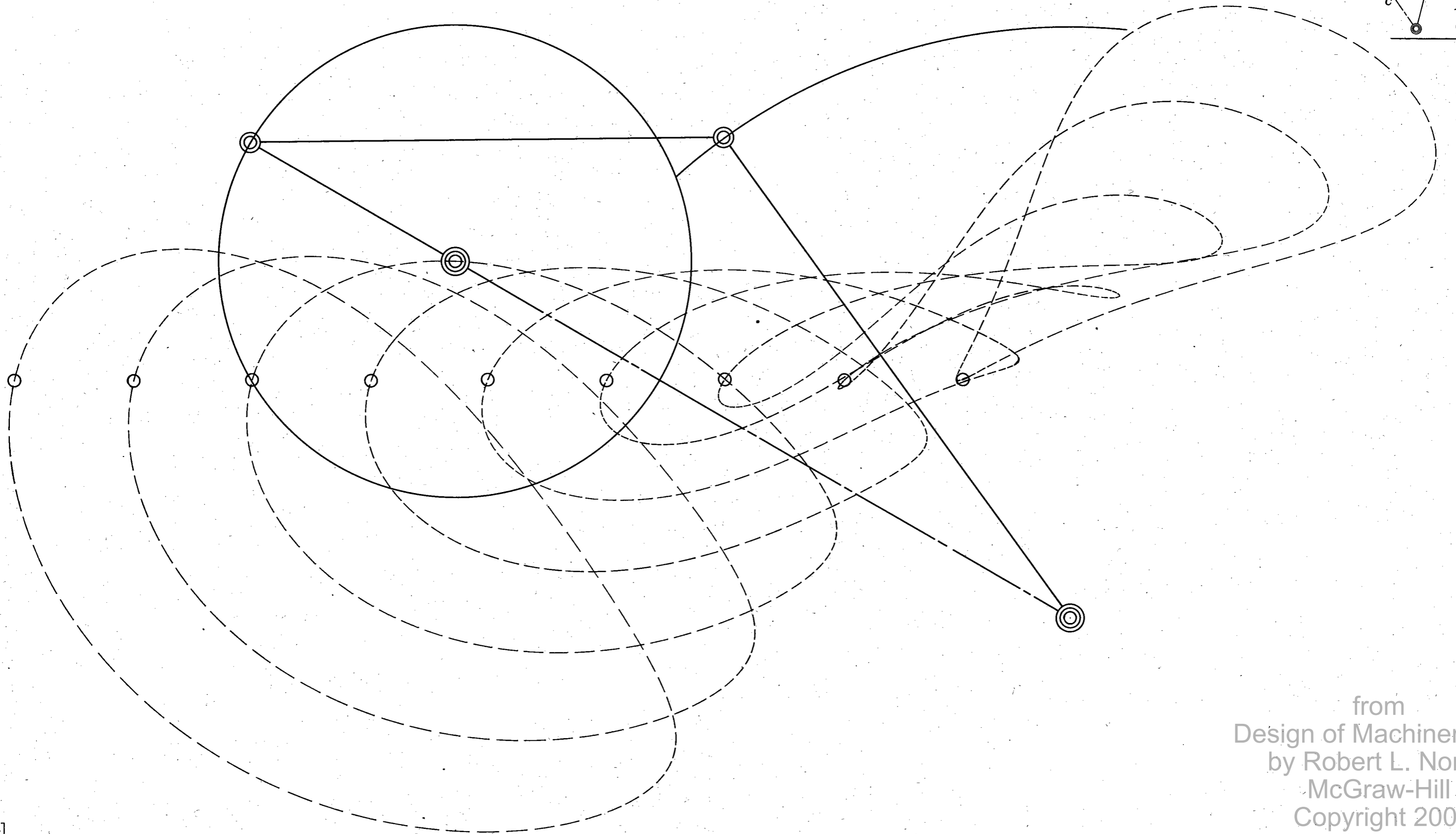
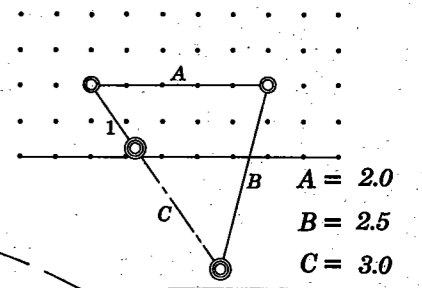

from  
Design of Machinery 4ed  
by Robert L. Norton  
McGraw-Hill  
Copyright 2008



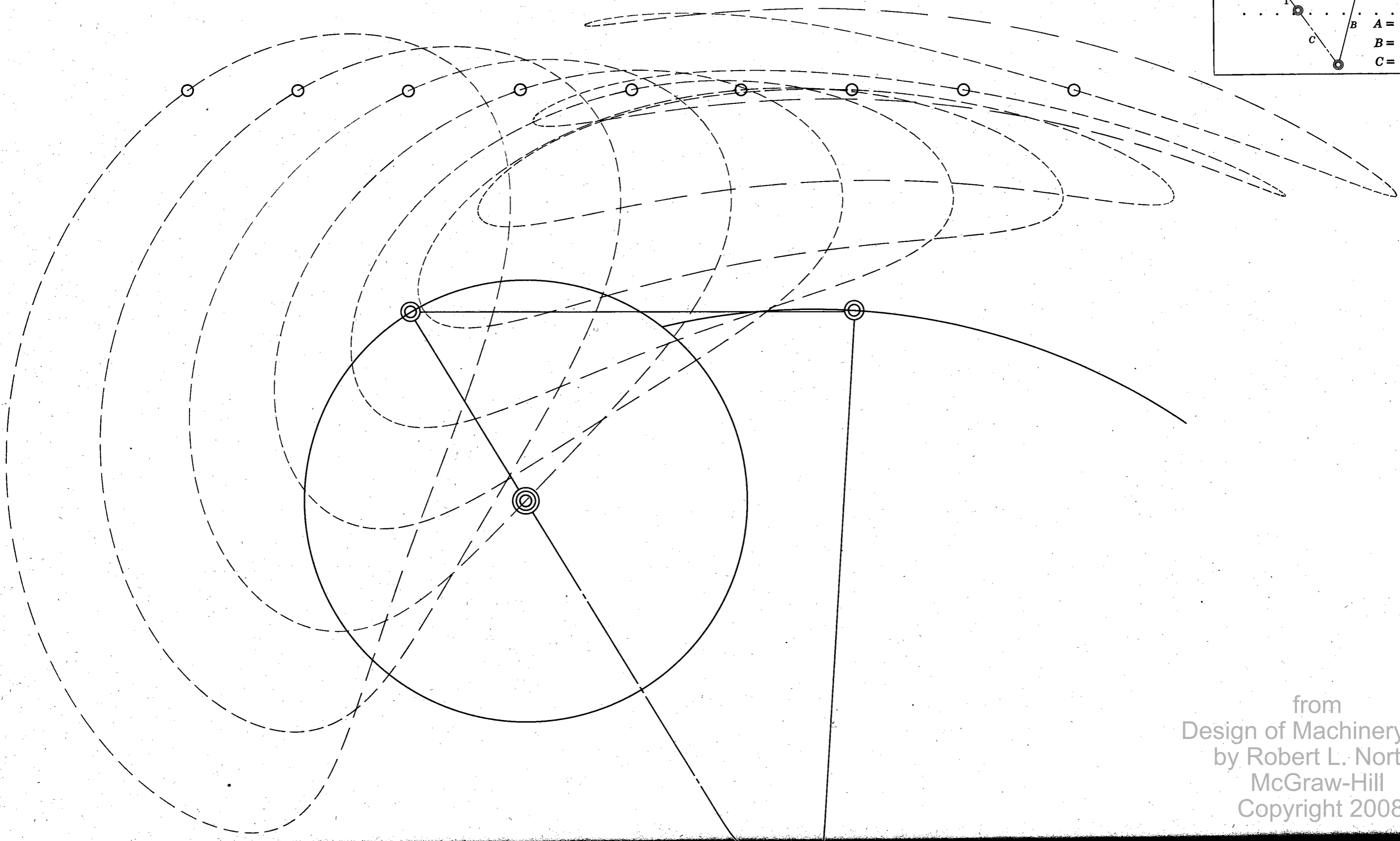
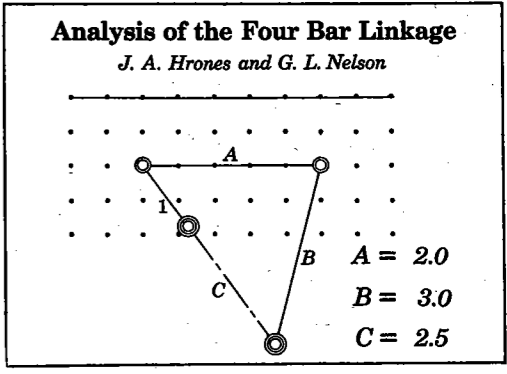

from  
Design of Machinery 4ed  
by Robert L. Norton  
McGraw-Hill  
Copyright 2008

**Analysis of the Four Bar Linkage**  
*J. A. Hrones and G. L. Nelson*

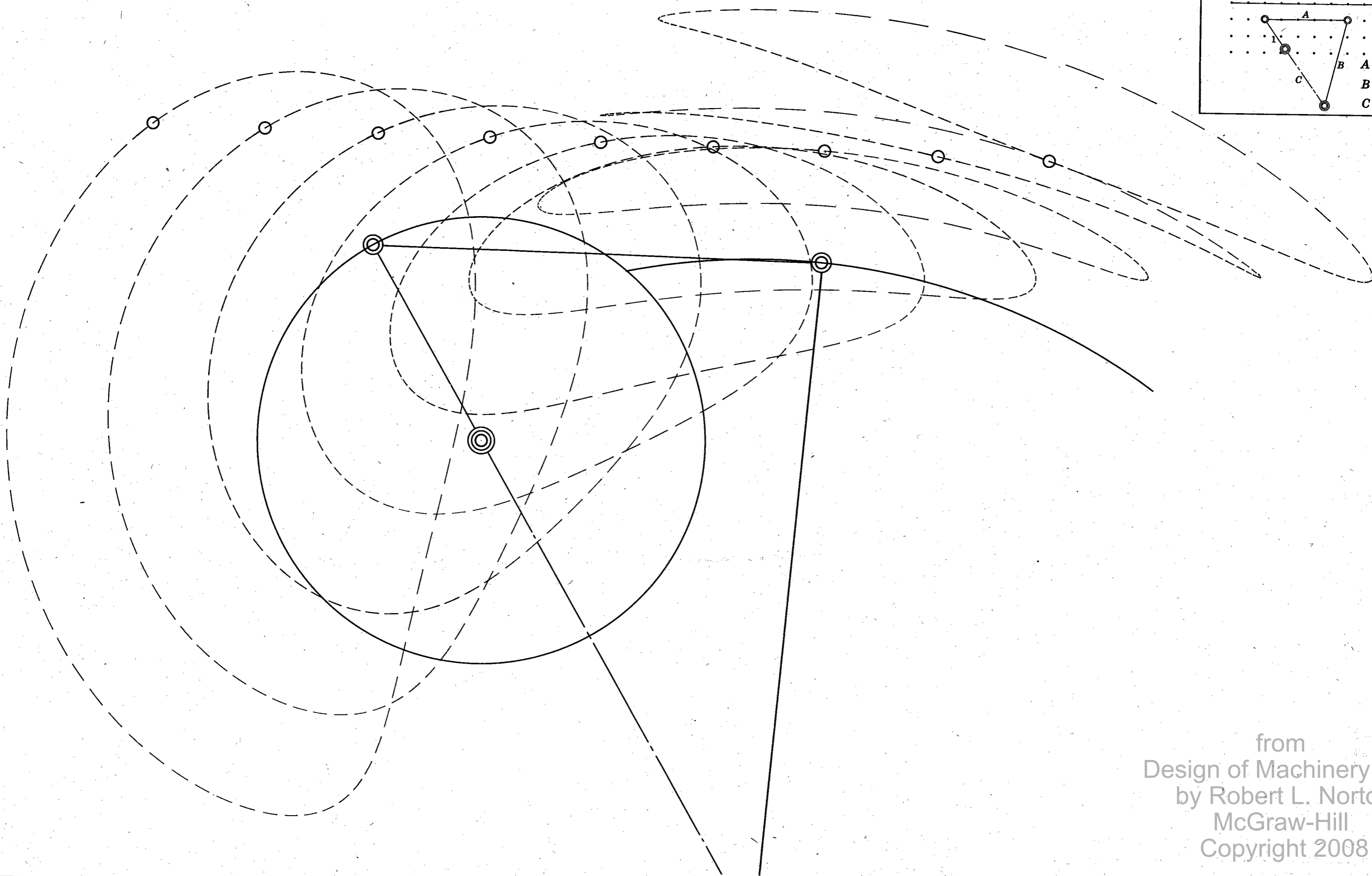
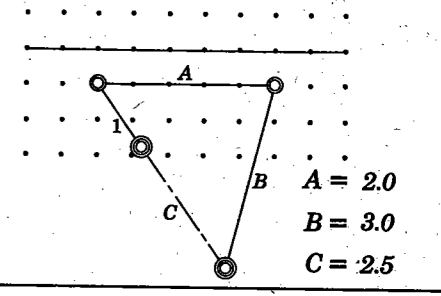

from  
Design of Machinery 4ed  
by Robert L. Norton  
McGraw-Hill  
Copyright 2008

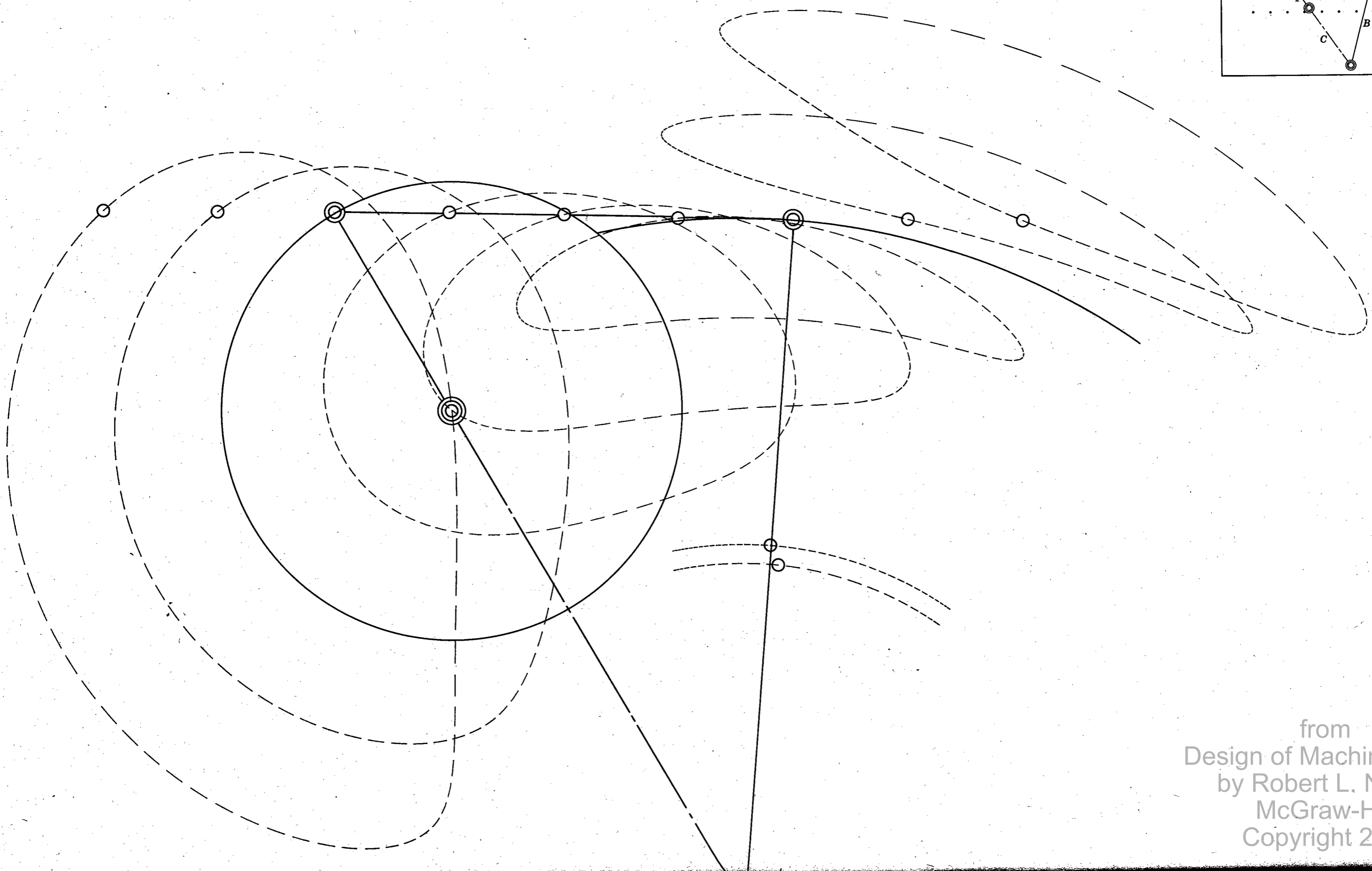
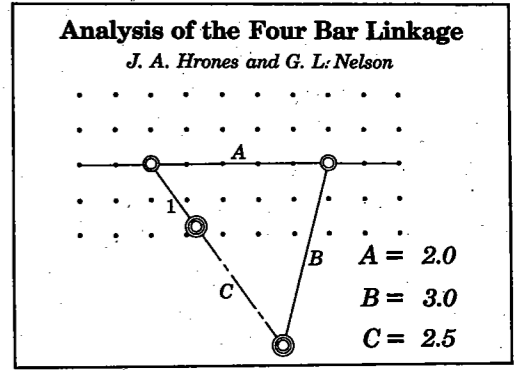

from  
Design of Machinery 4ed  
by Robert L. Norton  
McGraw-Hill  
Copyright 2008

**Analysis of the Four Bar Linkage**

*J. A. Hrones and G. L. Nelson*

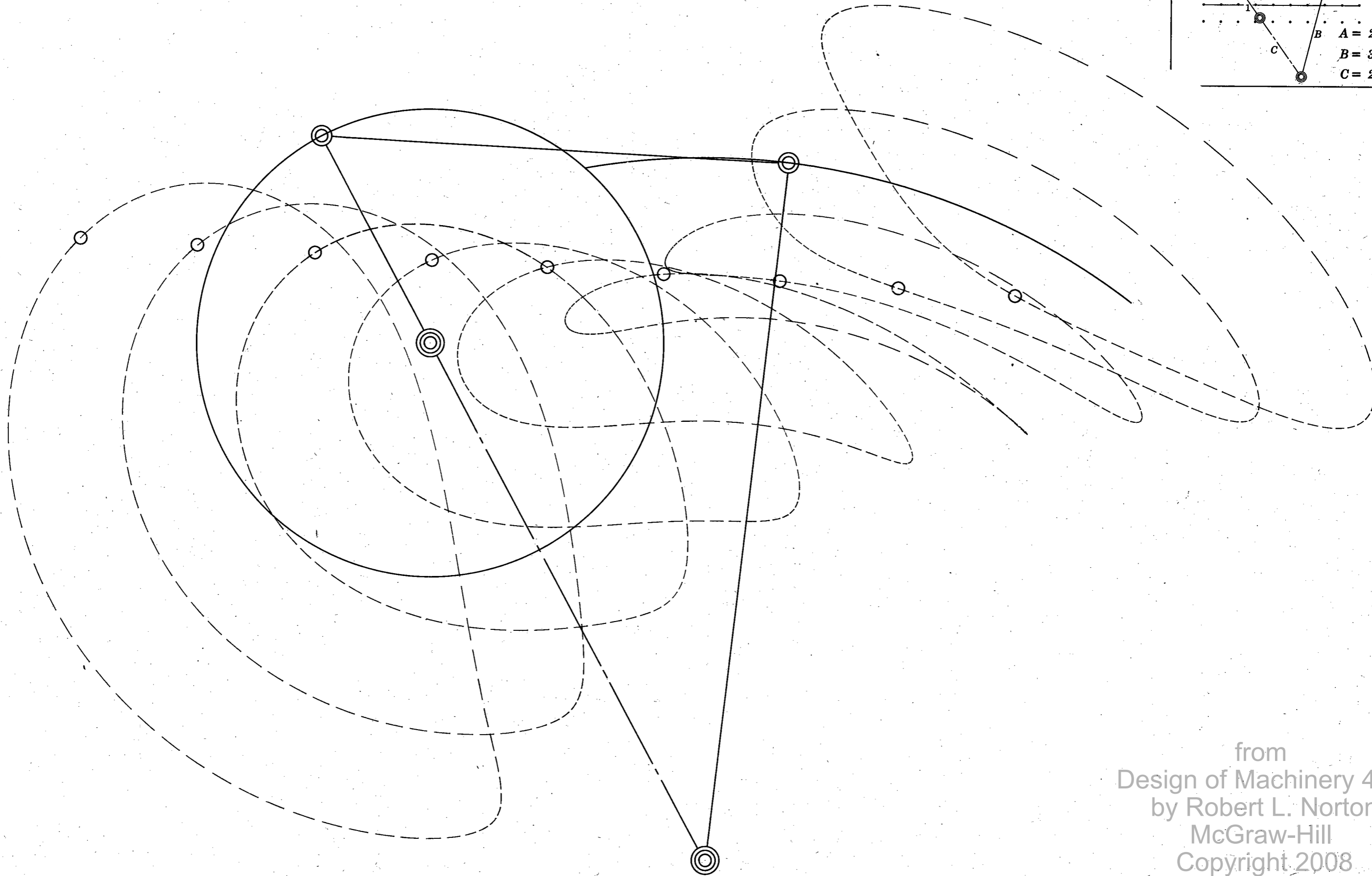
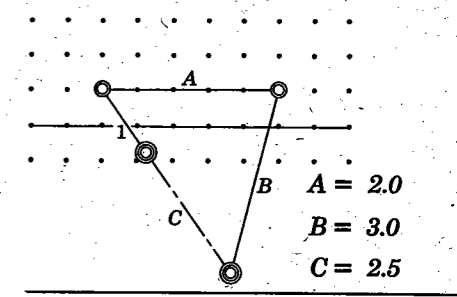

from  
Design of Machinery 4ed  
by Robert L. Norton  
McGraw-Hill  
Copyright 2008

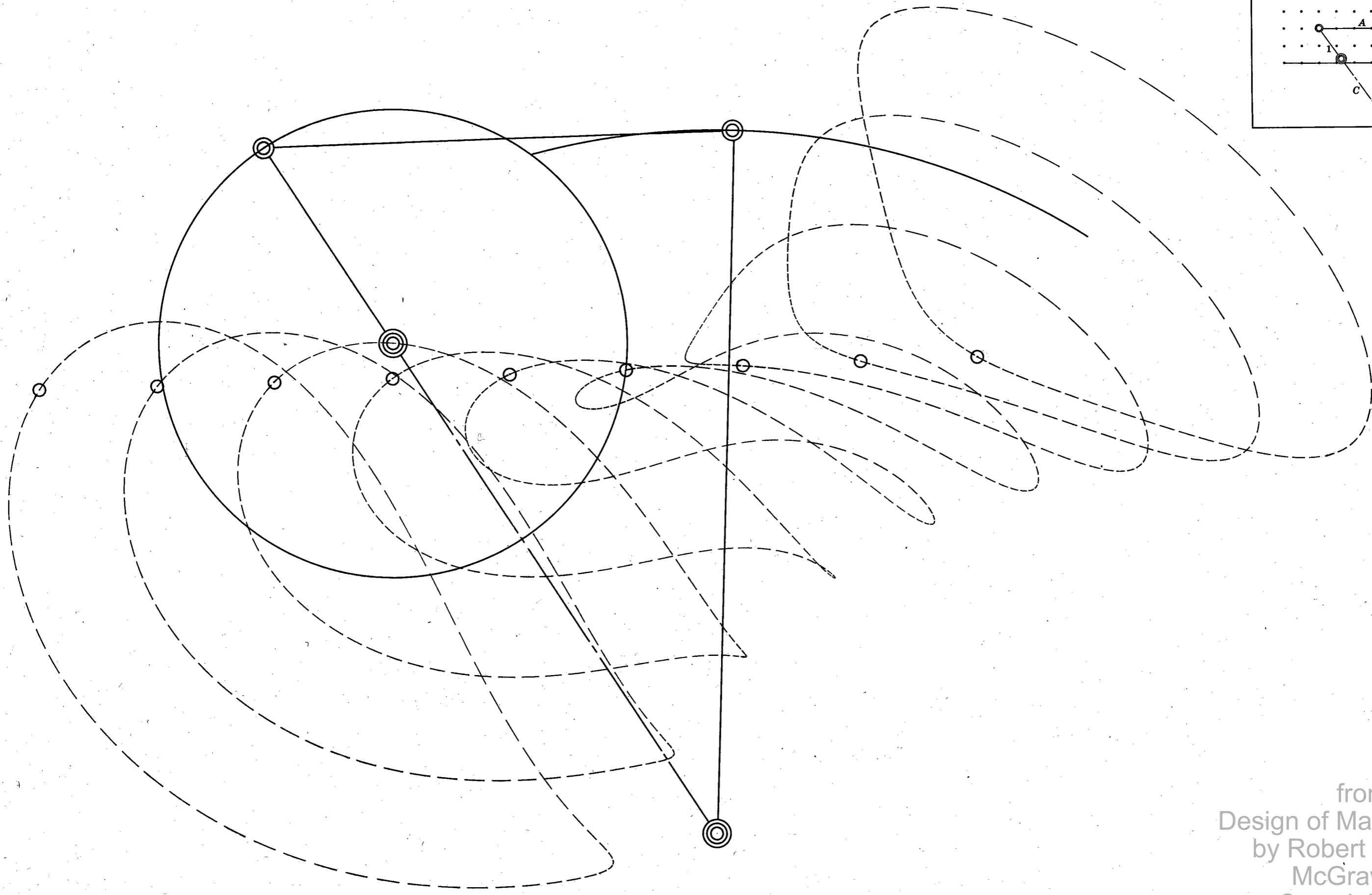
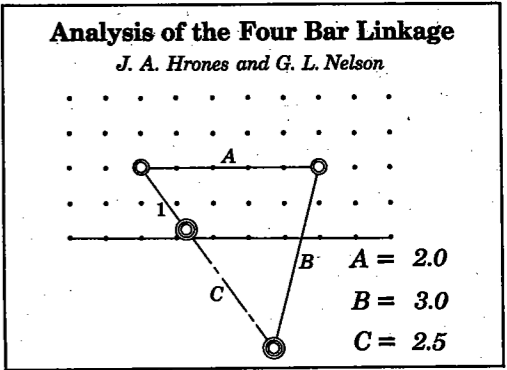

from  
Design of Machinery 4ed  
by Robert L. Norton  
McGraw-Hill  
Copyright 2008

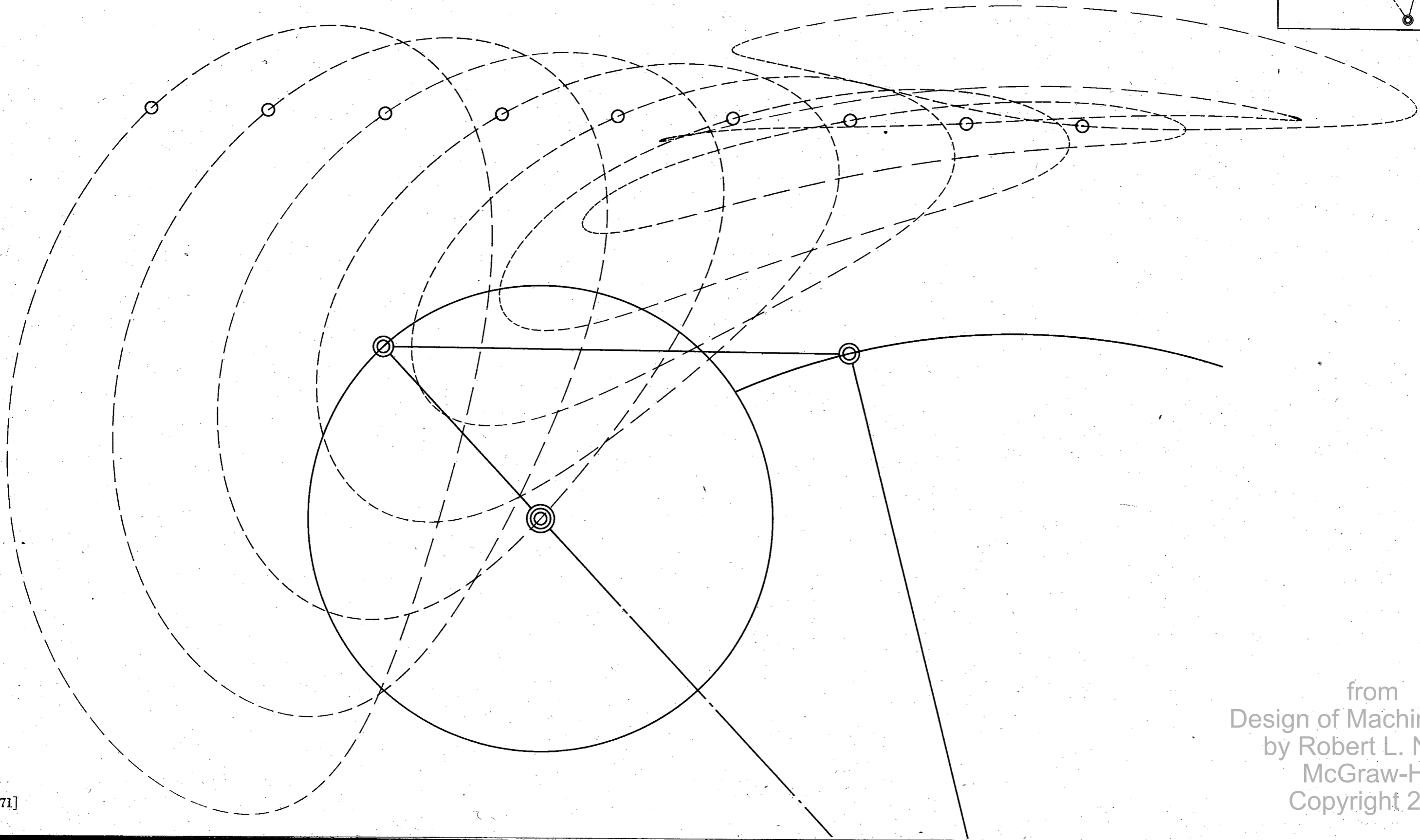
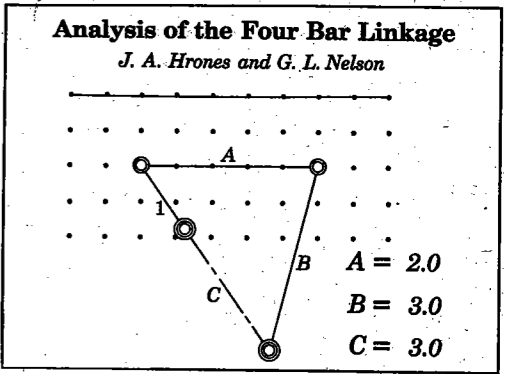

from  
 Design of Machinery 4ed  
 by Robert L. Norton  
 McGraw-Hill  
 Copyright 2008

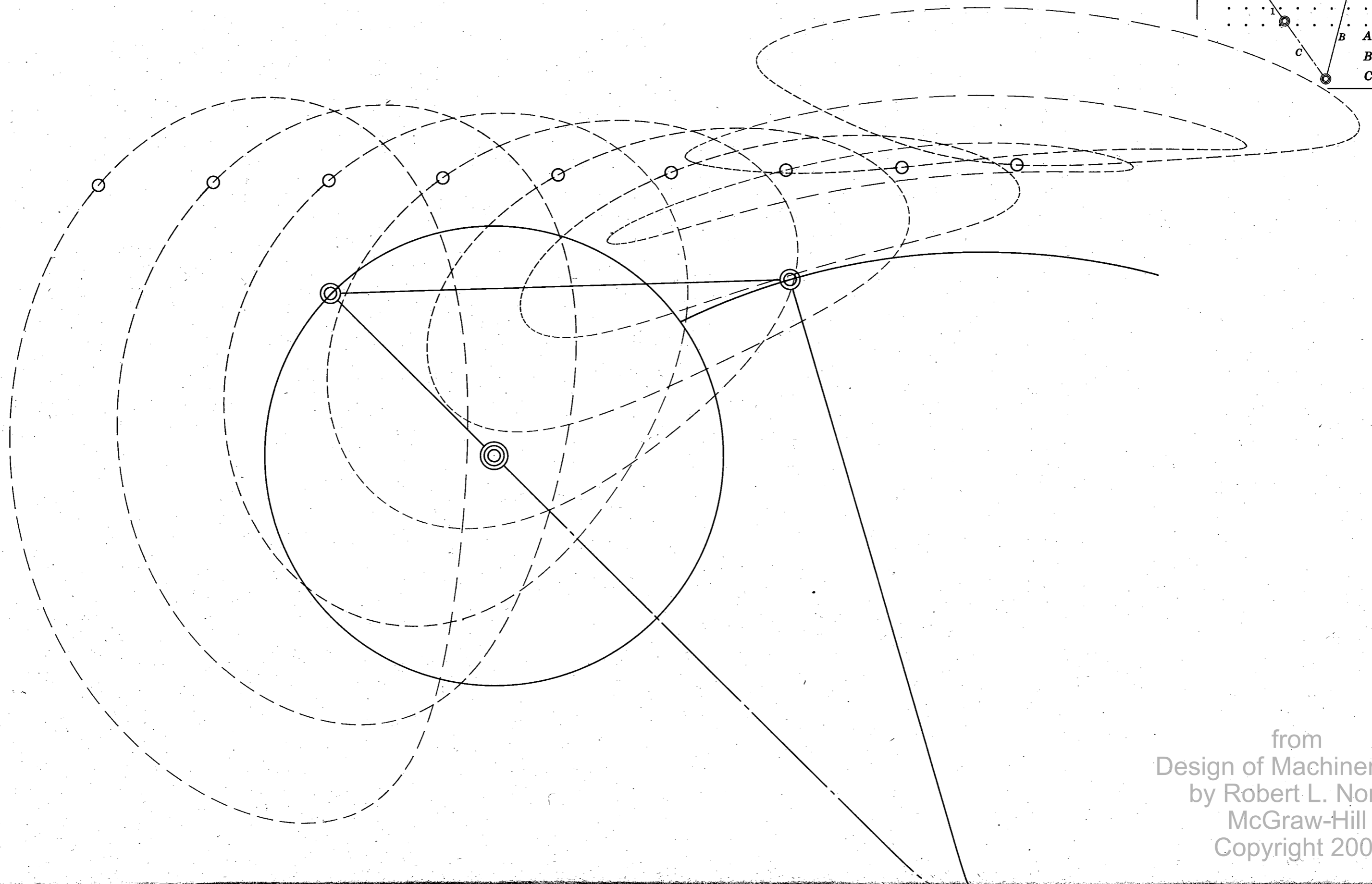
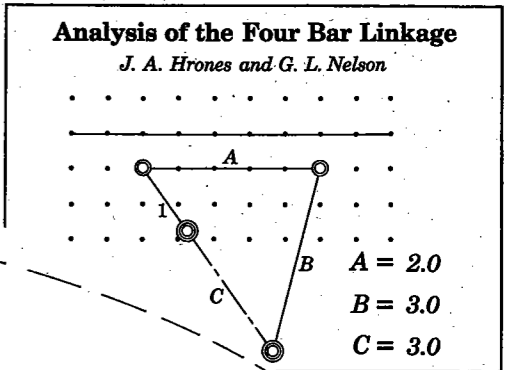

from  
Design of Machinery 4ed  
by Robert L. Norton  
McGraw-Hill  
Copyright 2008

**Analysis of the Four Bar Linkage**

*J. A. Hrones and G. L. Nelson*

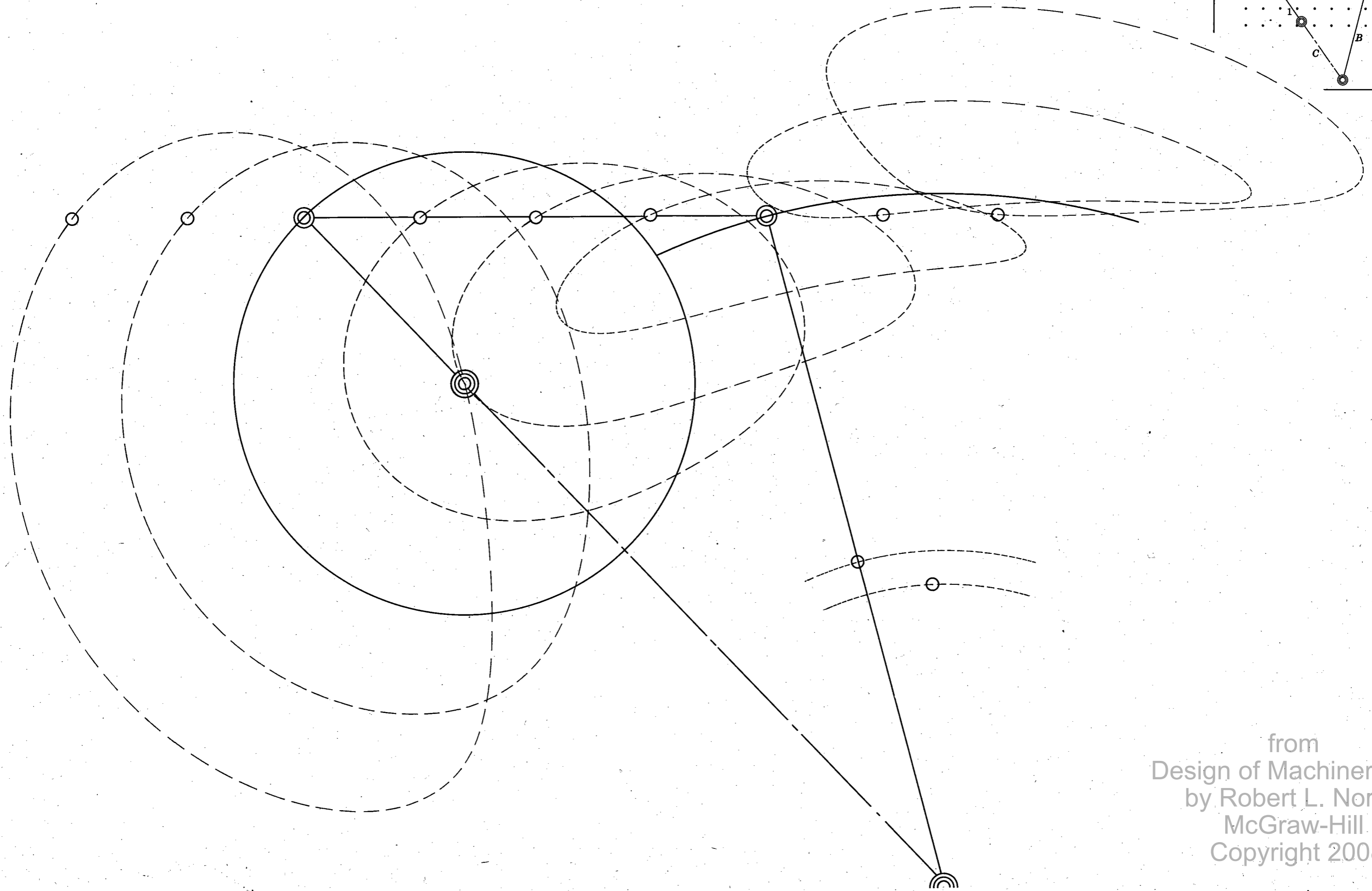
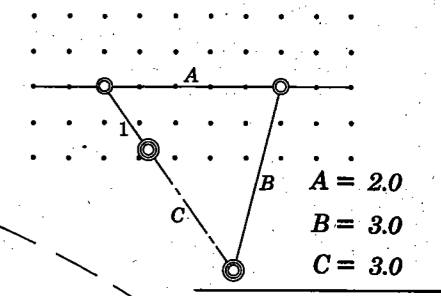

from  
Design of Machinery 4ed  
by Robert L. Norton  
McGraw-Hill  
Copyright 2008



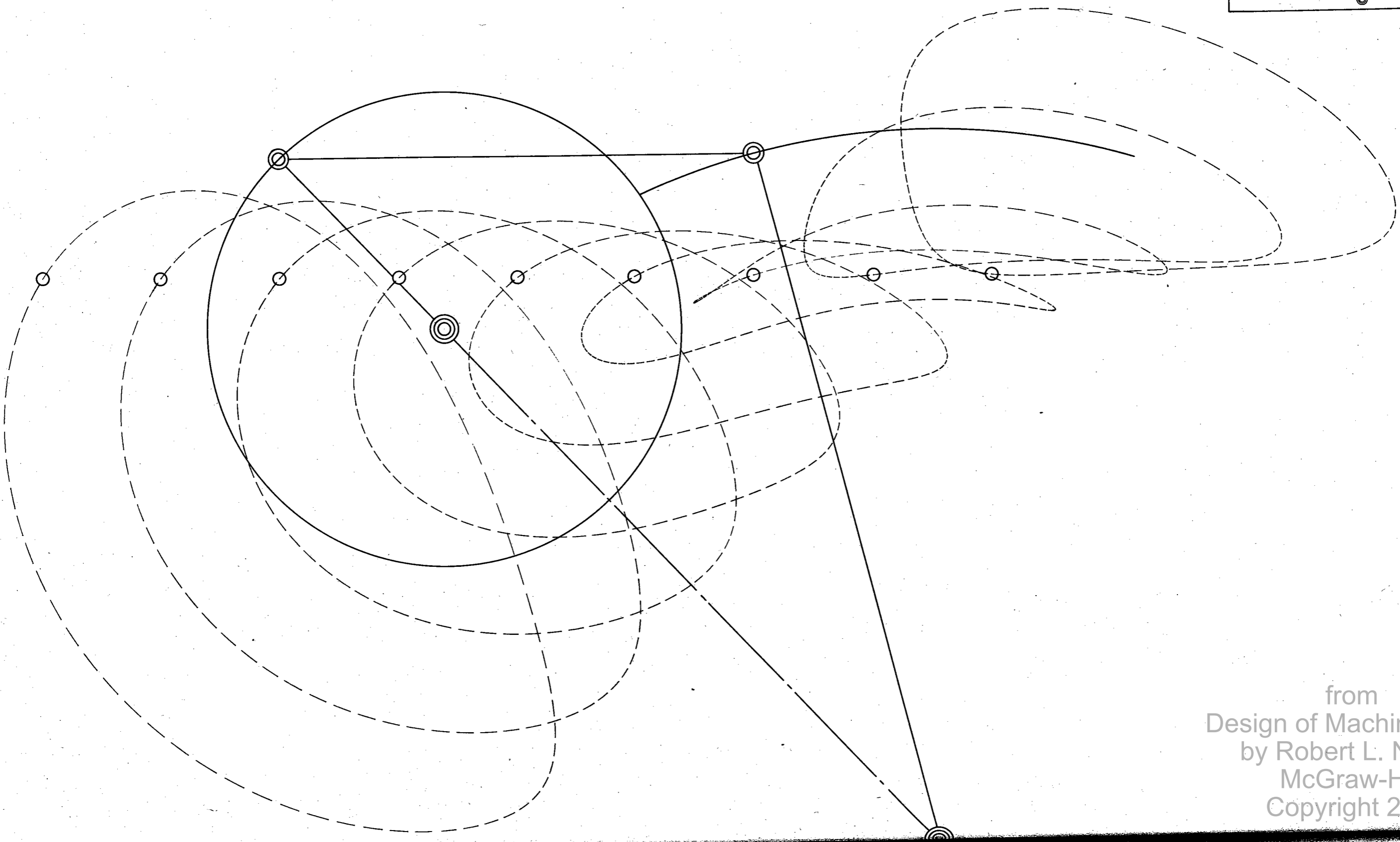
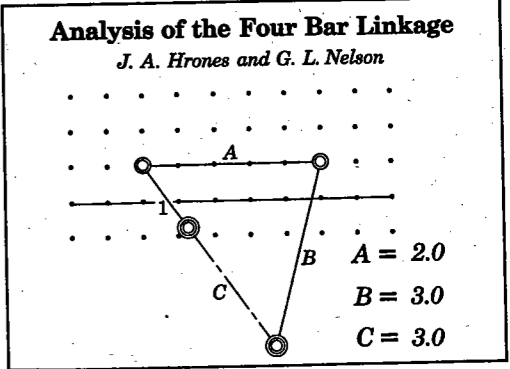

from  
Design of Machinery 4ed  
by Robert L. Norton  
McGraw-Hill  
Copyright 2008

**Analysis of the Four Bar Linkage**

*J. A. Hrones and G. L. Nelson*

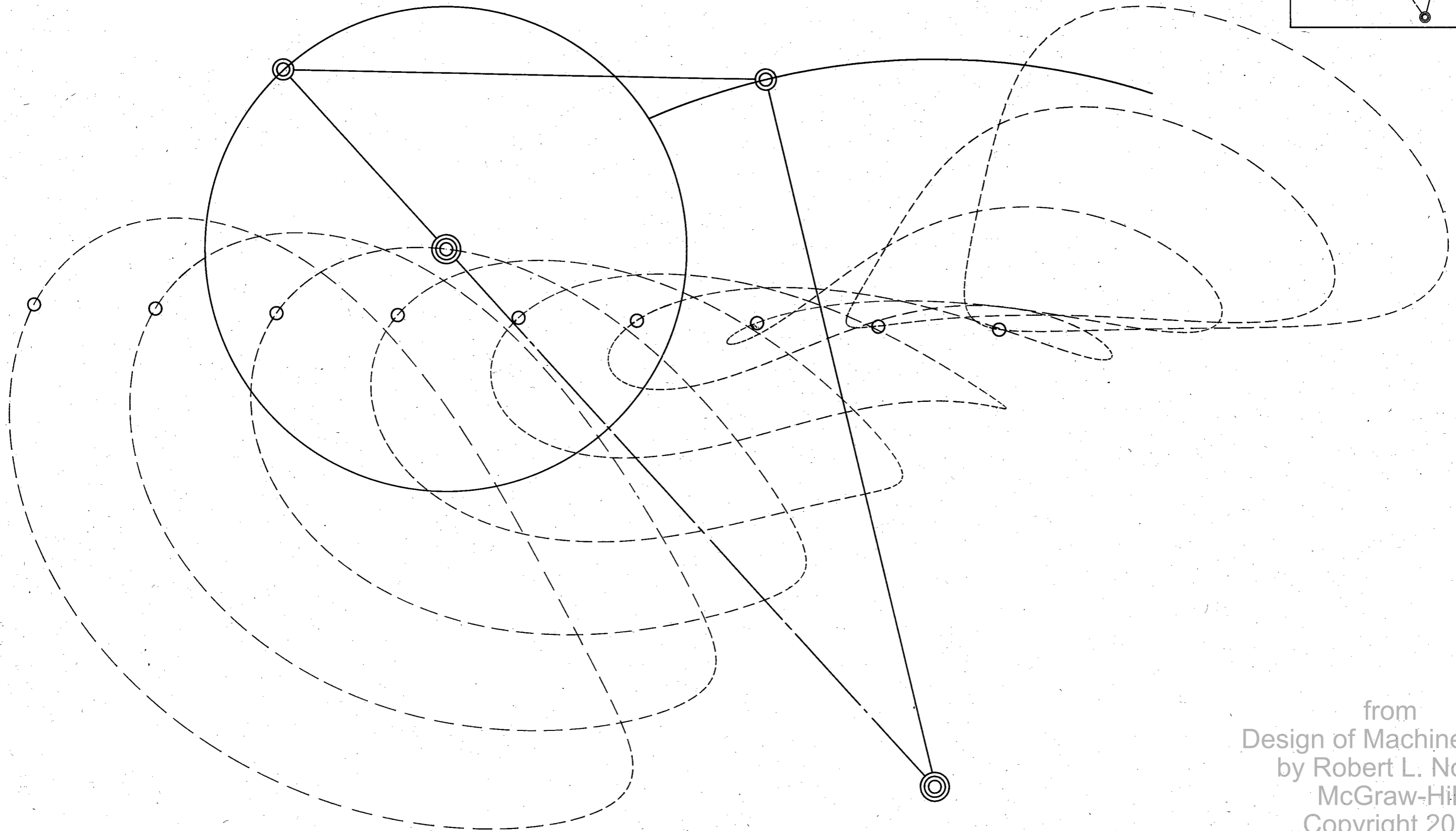
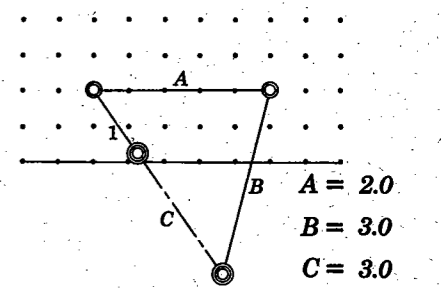

from  
Design of Machinery 4ed  
by Robert L. Norton  
McGraw-Hill  
Copyright 2008

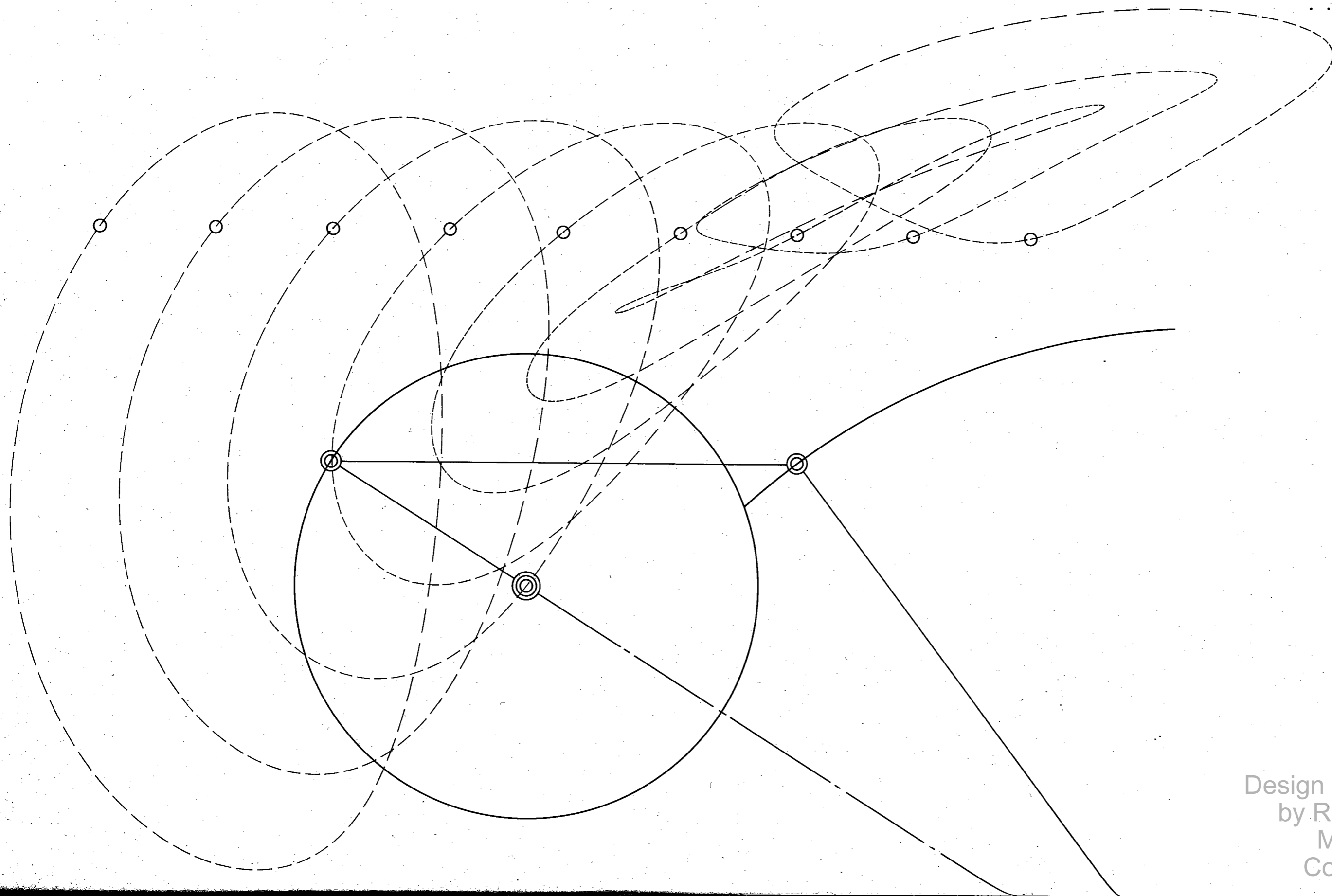
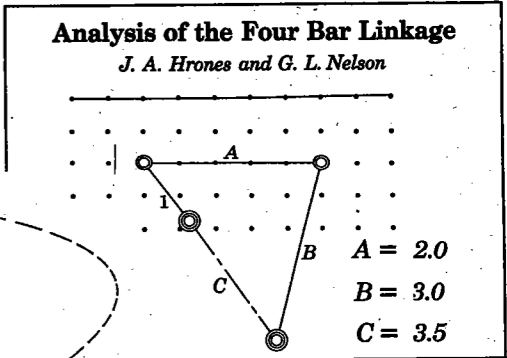

from  
Design of Machinery 4ed  
by Robert L. Norton  
McGraw-Hill  
Copyright 2008

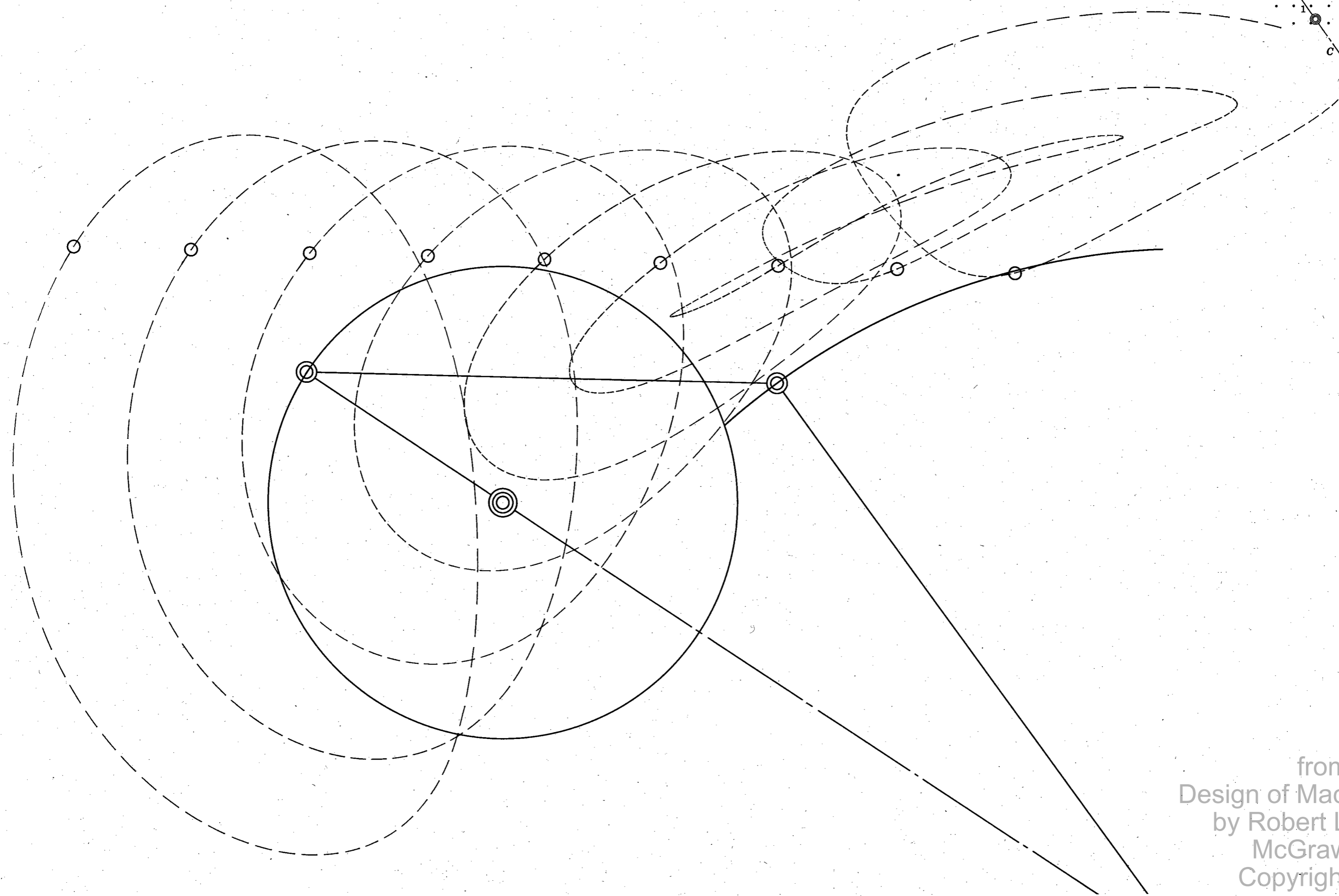
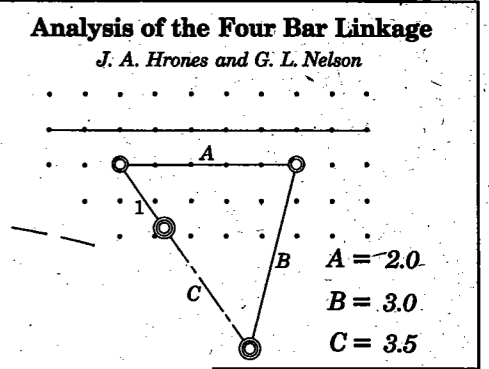

from  
 Design of Machinery 4ed  
 by Robert L. Norton  
 McGraw-Hill  
 Copyright 2008

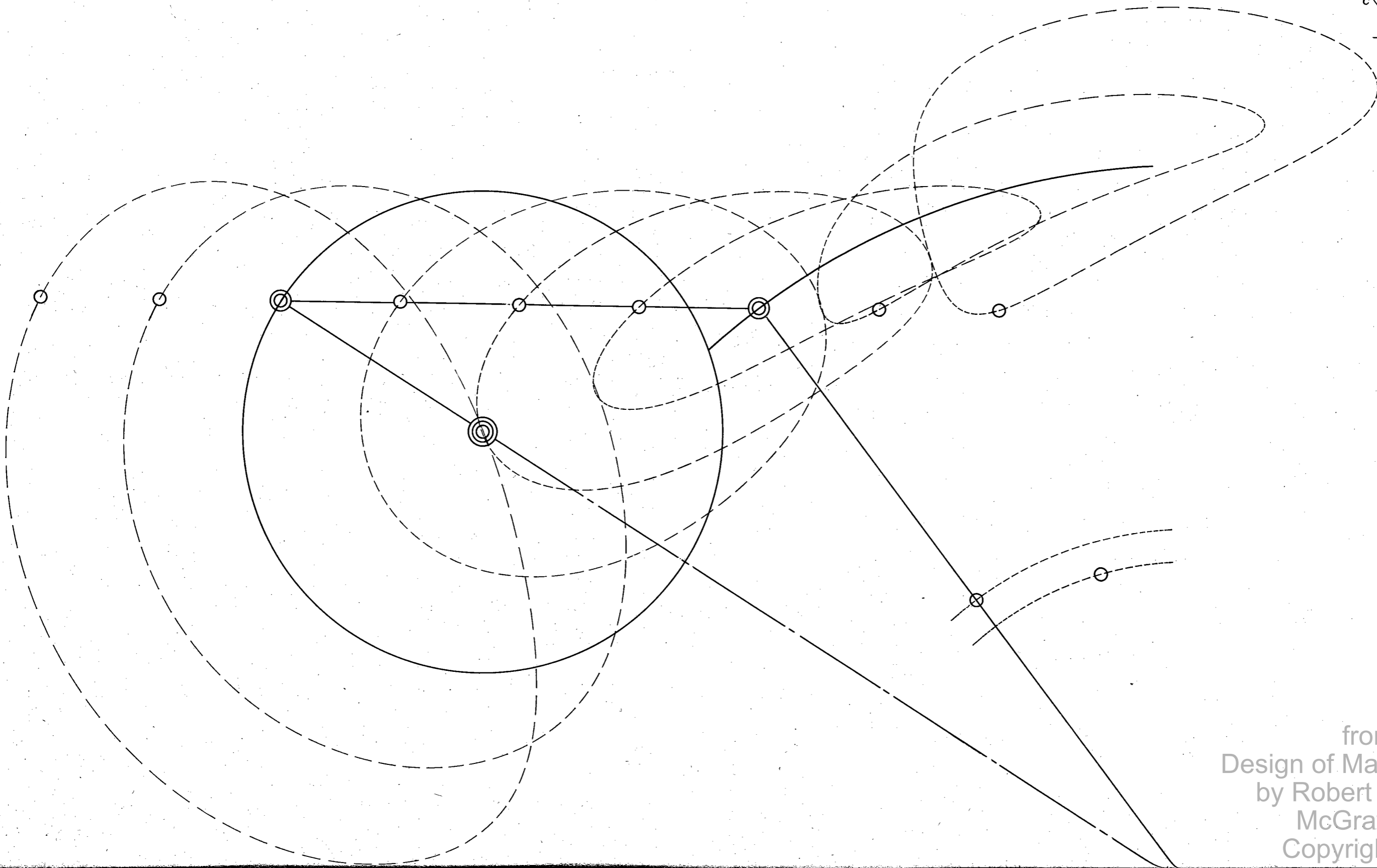
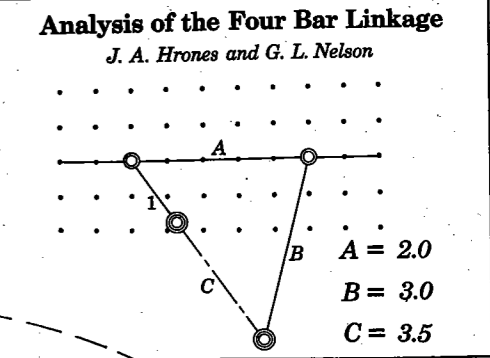

from  
Design of Machinery 4ed  
by Robert L. Norton  
McGraw-Hill  
Copyright 2008

**Analysis of the Four Bar Linkage**  
*J. A. Hrones and G. L. Nelson*

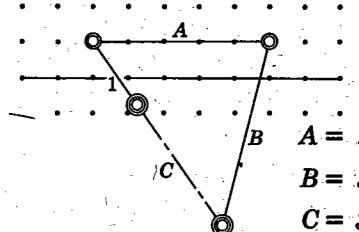

$A = 2.0$   
 $B = 3.0$   
 $C = 3.5$

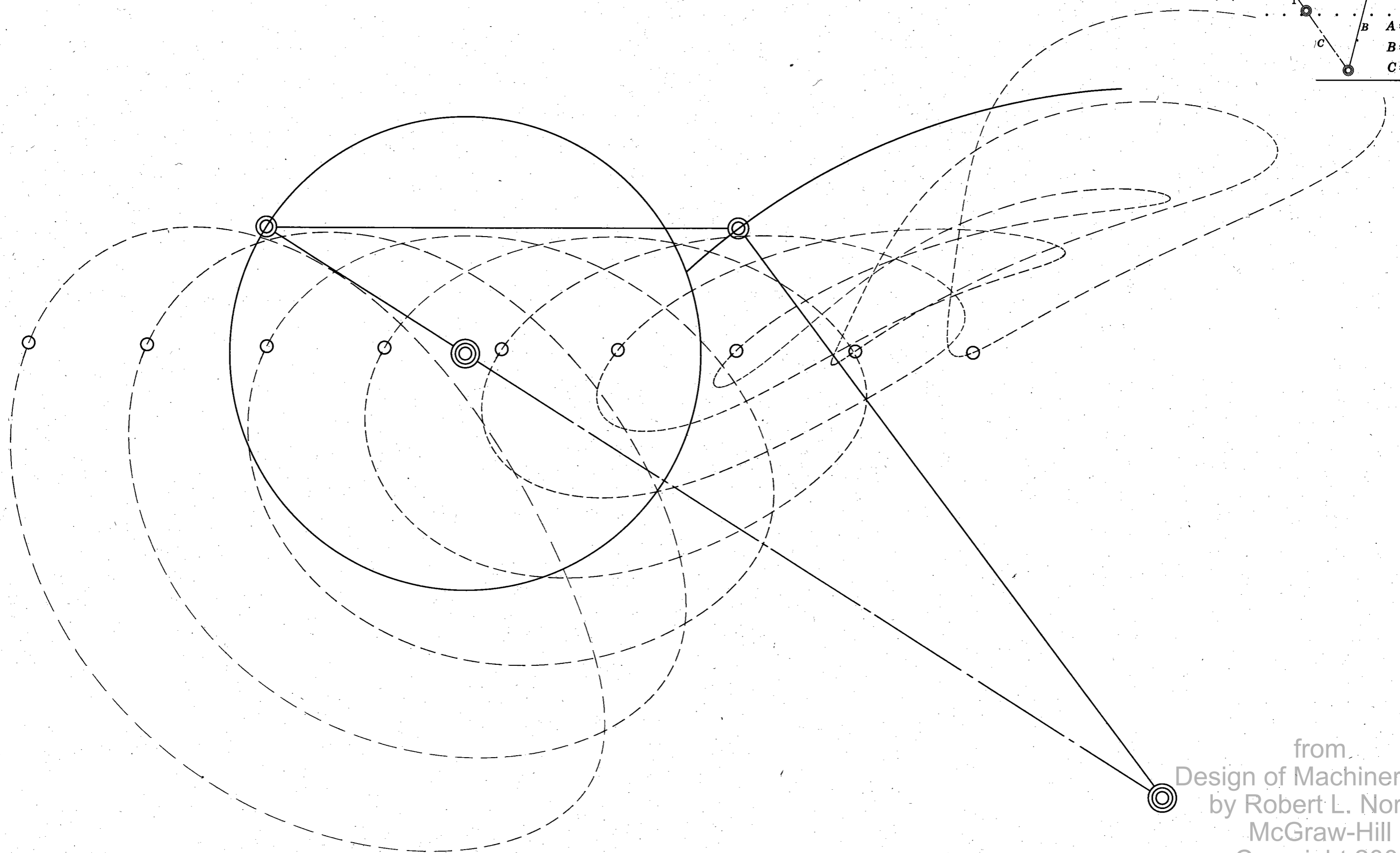

from  
 Design of Machinery 4ed  
 by Robert L. Norton  
 McGraw-Hill  
 Copyright 2008

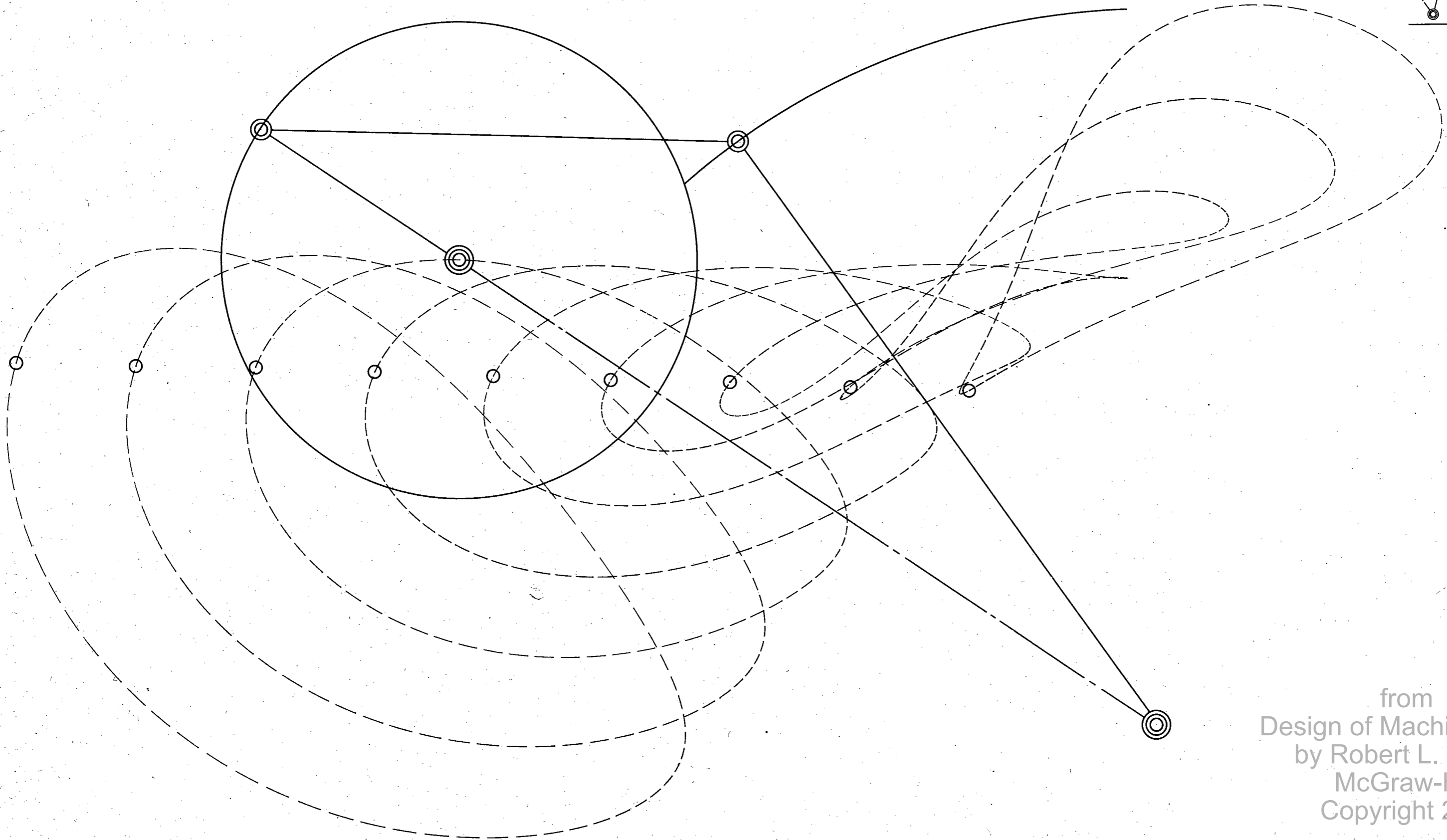
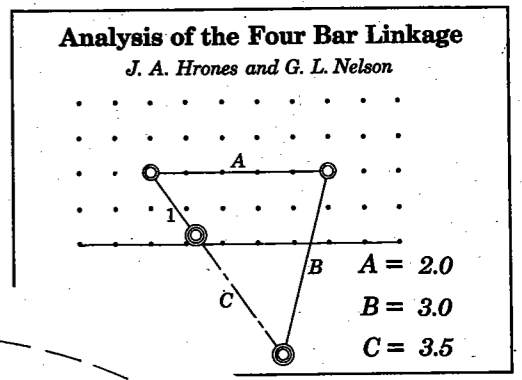

from  
Design of Machinery 4ed  
by Robert L. Norton  
McGraw-Hill  
Copyright 2008

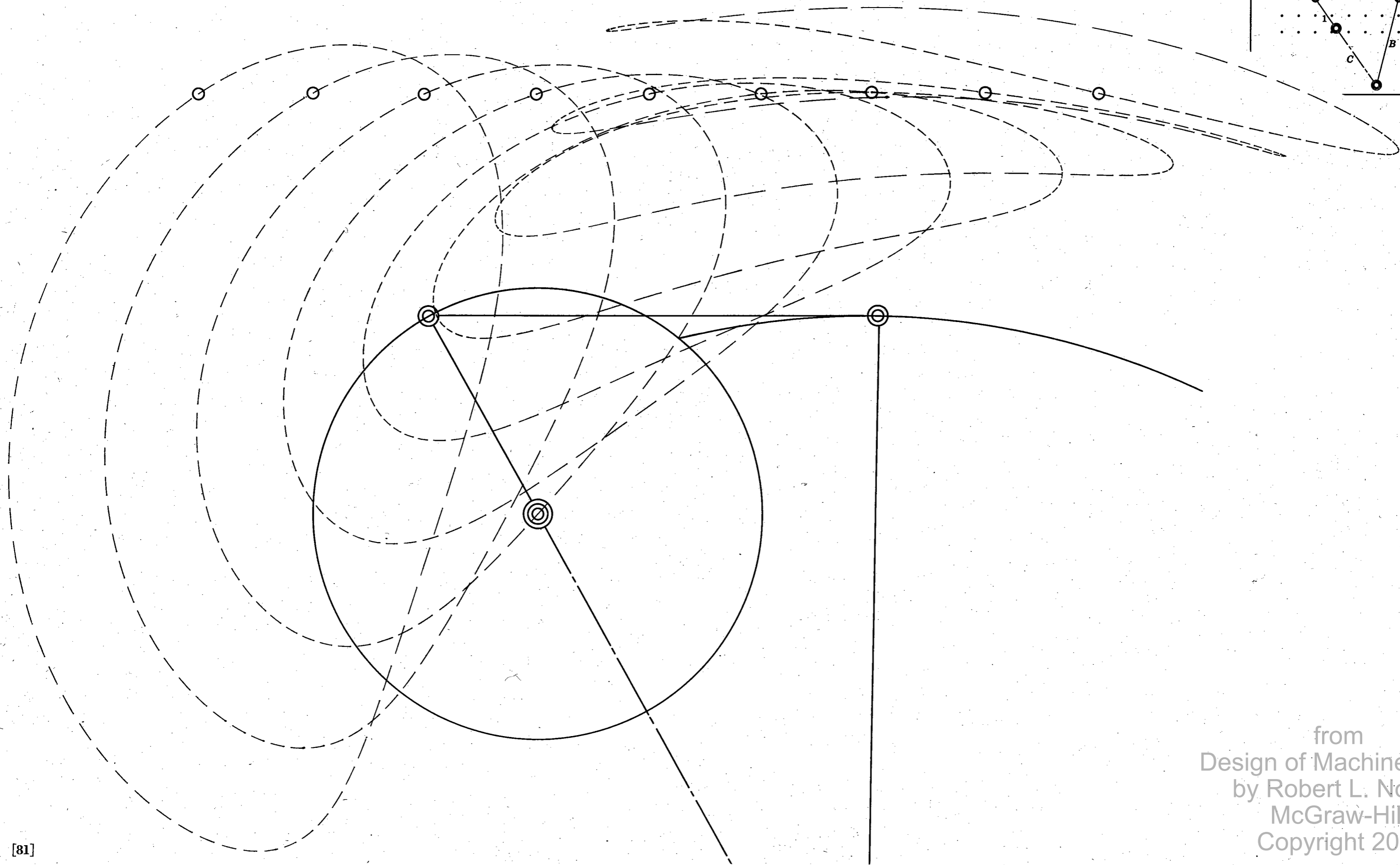
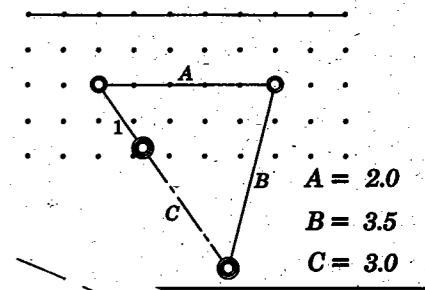

from  
Design of Machinery 4ed  
by Robert L. Norton  
McGraw-Hill  
Copyright 2008



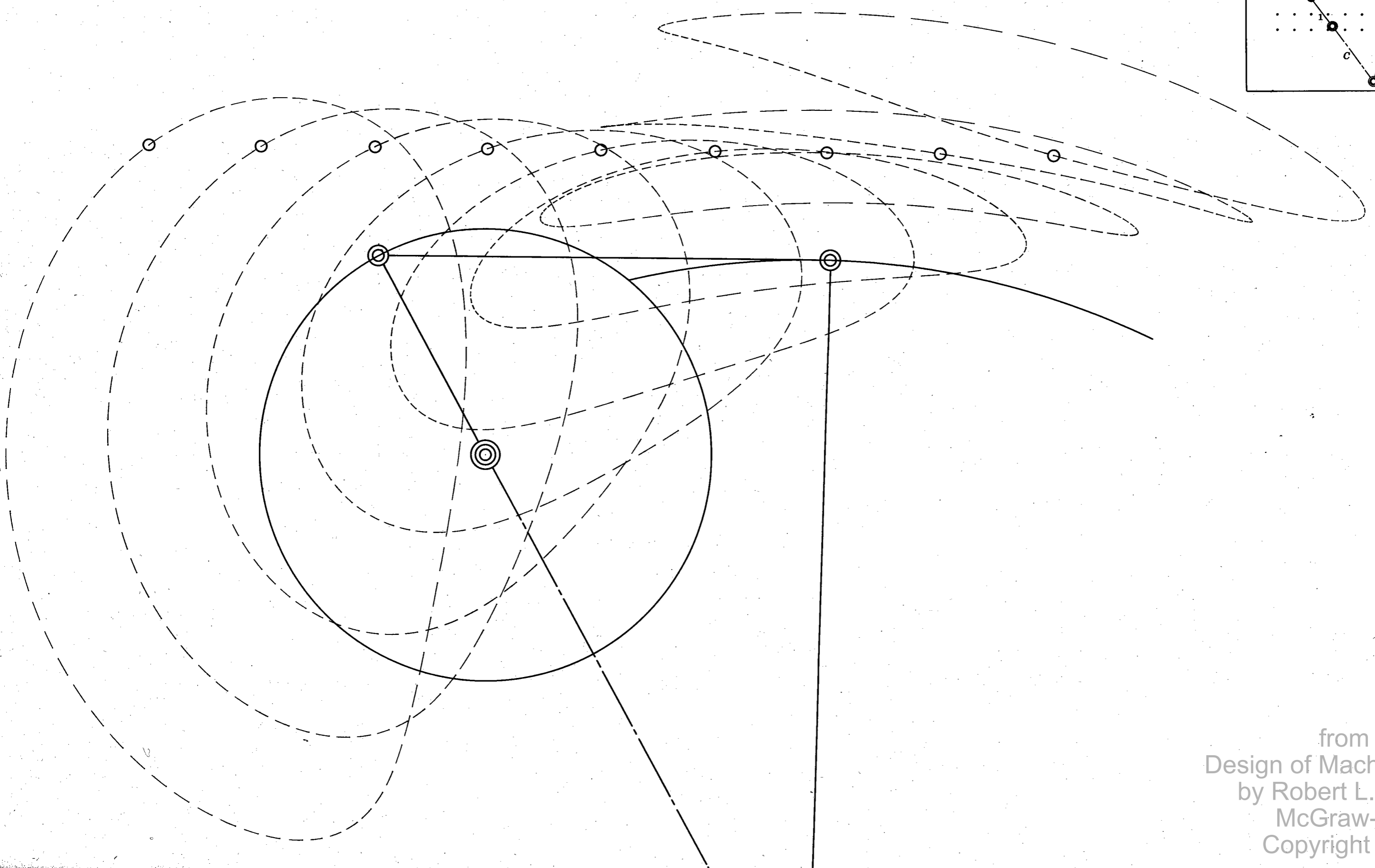
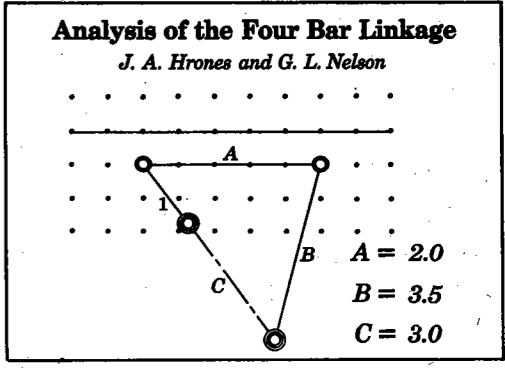

from  
Design of Machinery 4ed  
by Robert L. Norton  
McGraw-Hill  
Copyright 2008

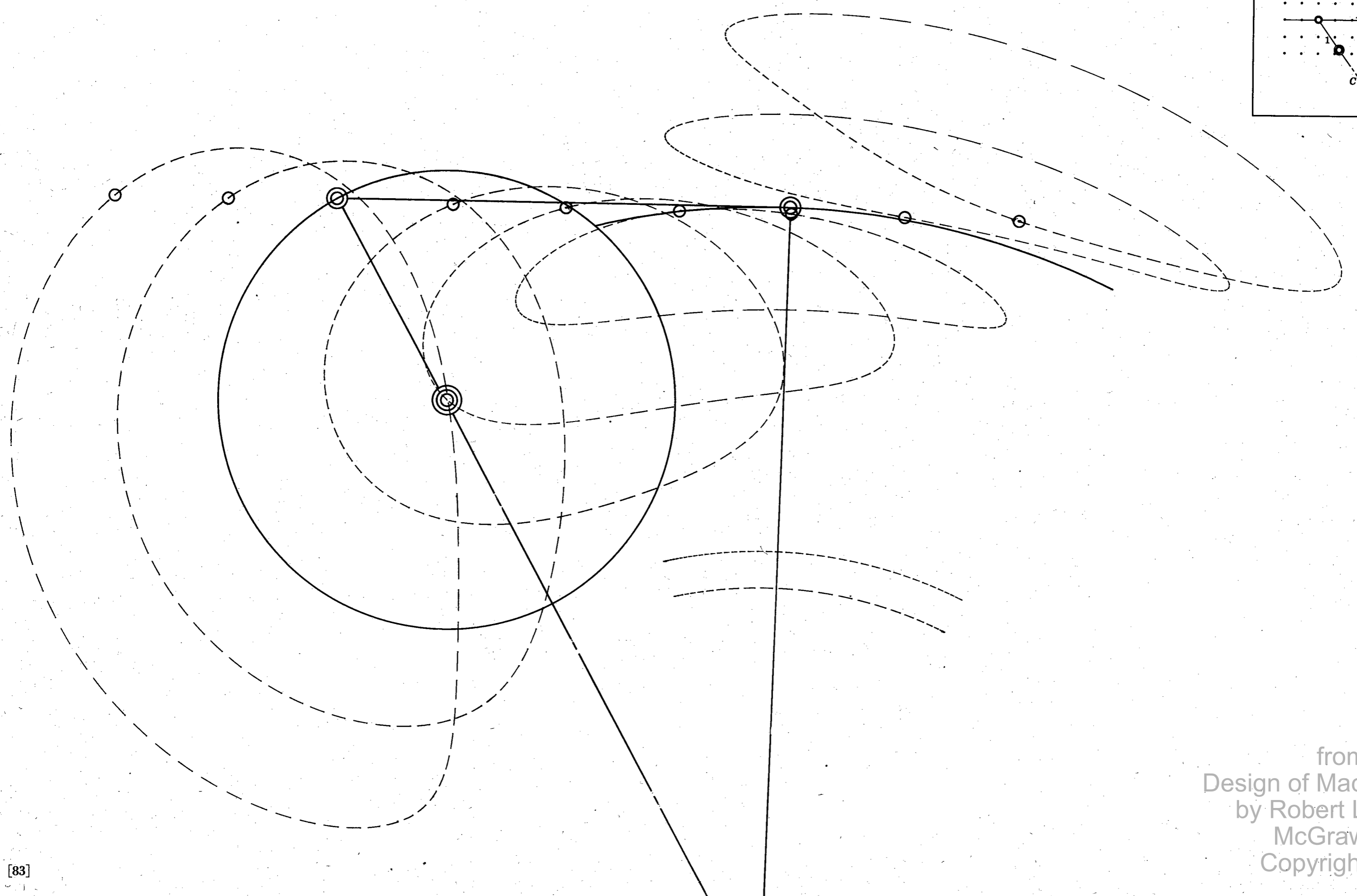
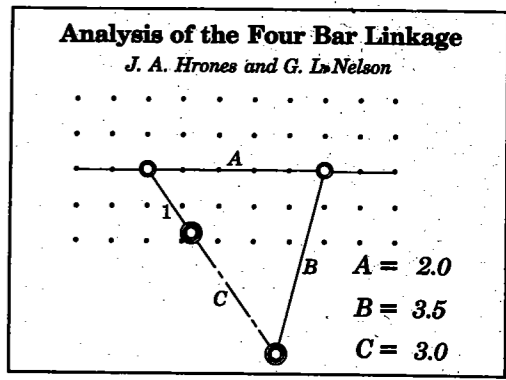

from  
 Design of Machinery 4ed  
 by Robert L. Norton  
 McGraw-Hill  
 Copyright 2008

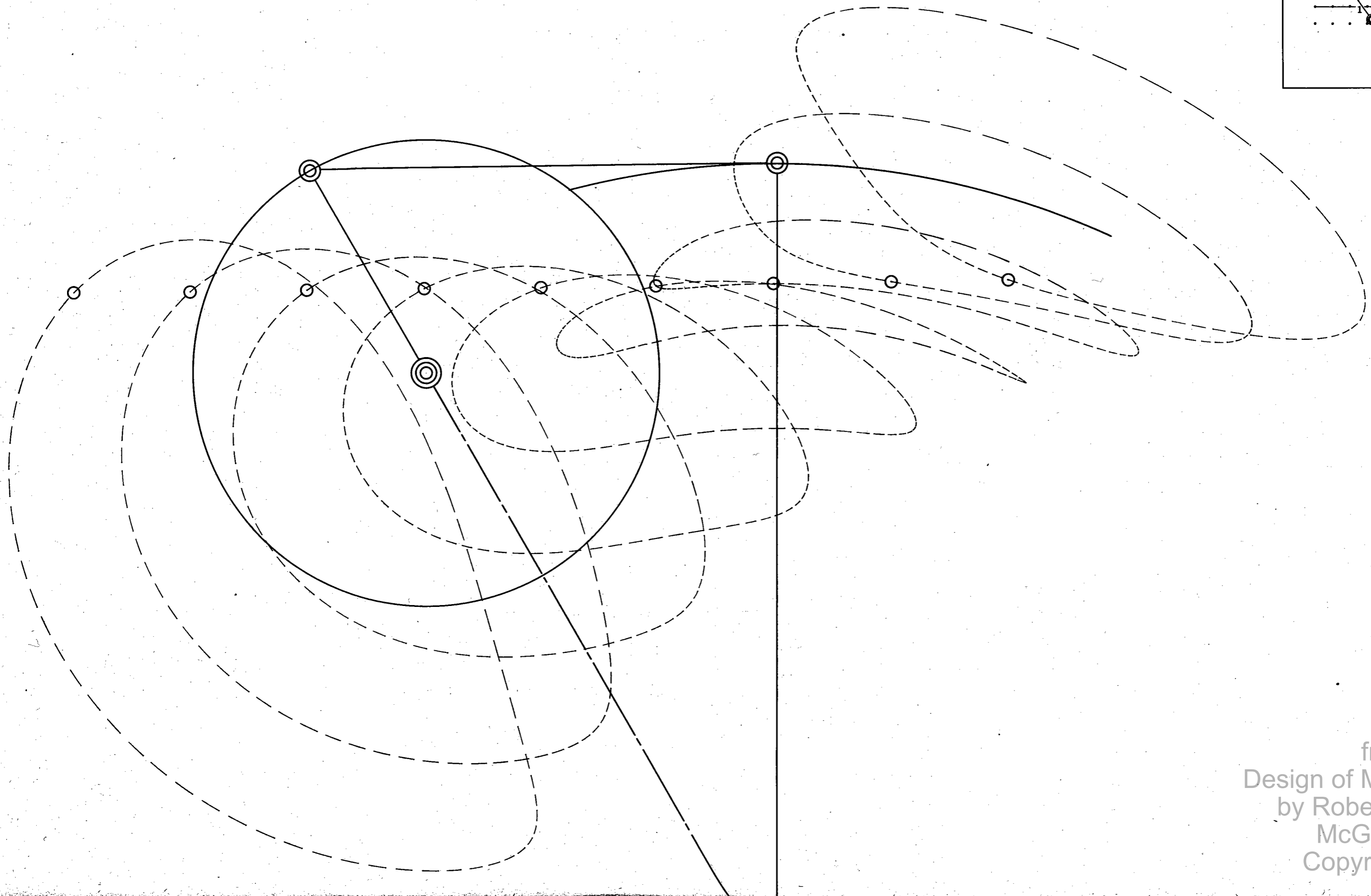
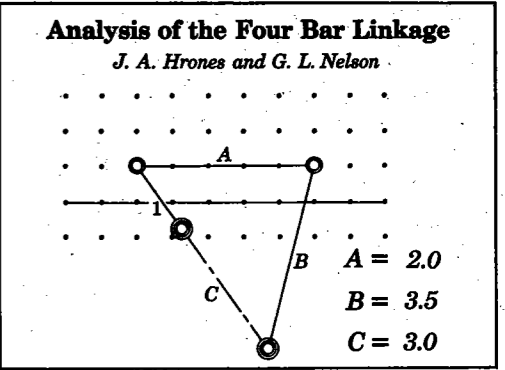

from  
Design of Machinery 4ed  
by Robert L. Norton  
McGraw-Hill  
Copyright 2008

**Analysis of the Four Bar Linkage**

*J. A. Hrones and G. L. Nelson*

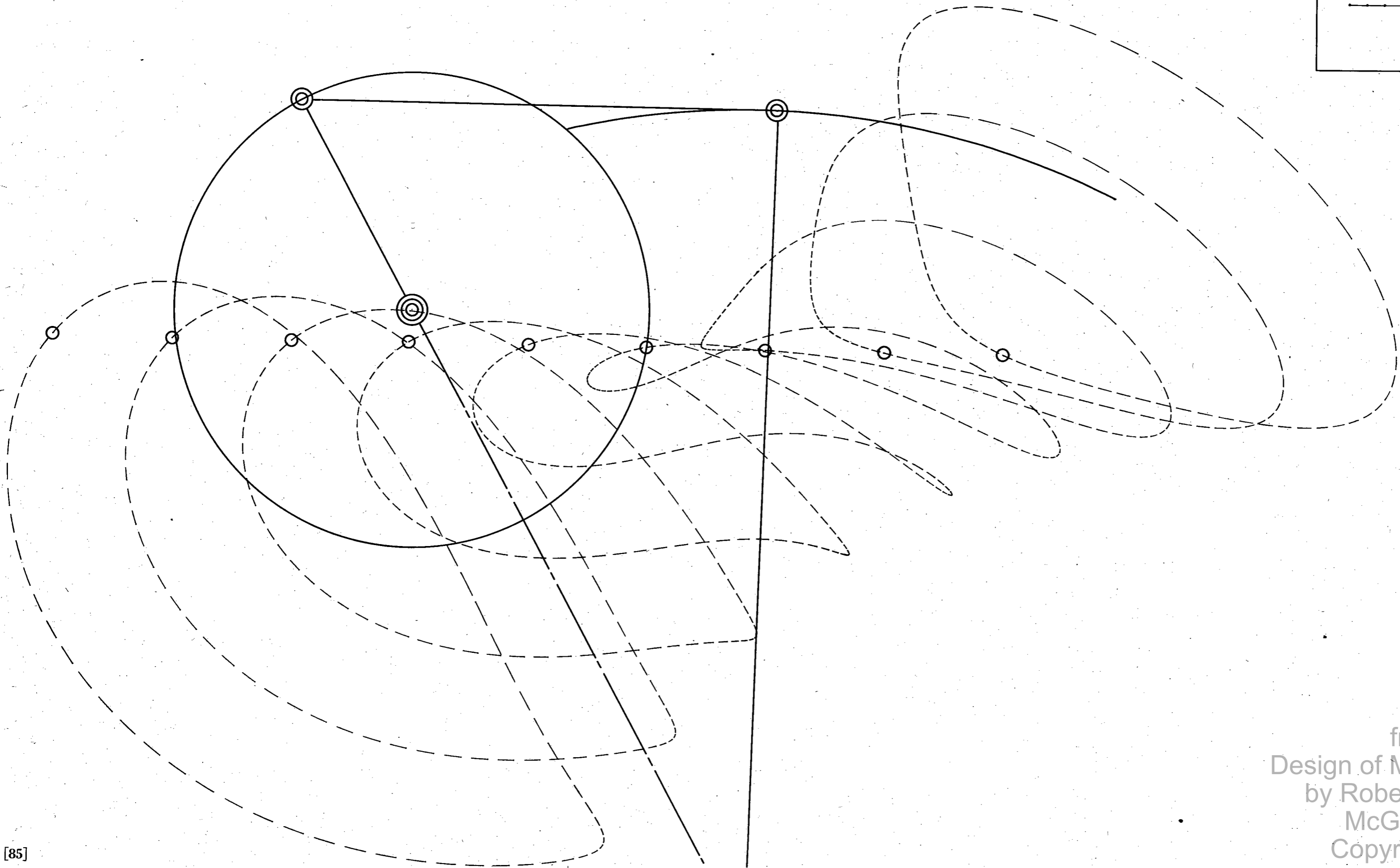
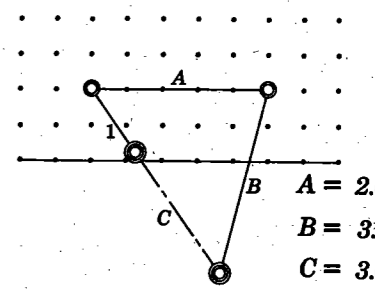

from  
Design of Machinery 4ed  
by Robert L. Norton  
McGraw-Hill  
Copyright 2008

**Analysis of the Four Bar Linkage**  
*J. A. Hrones and G. L. Nelson*

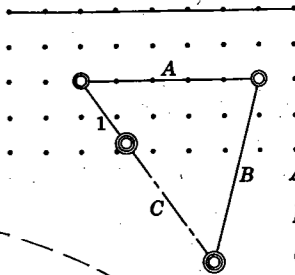

$A = 2.0$   
 $B = 3.5$   
 $C = 3.5$

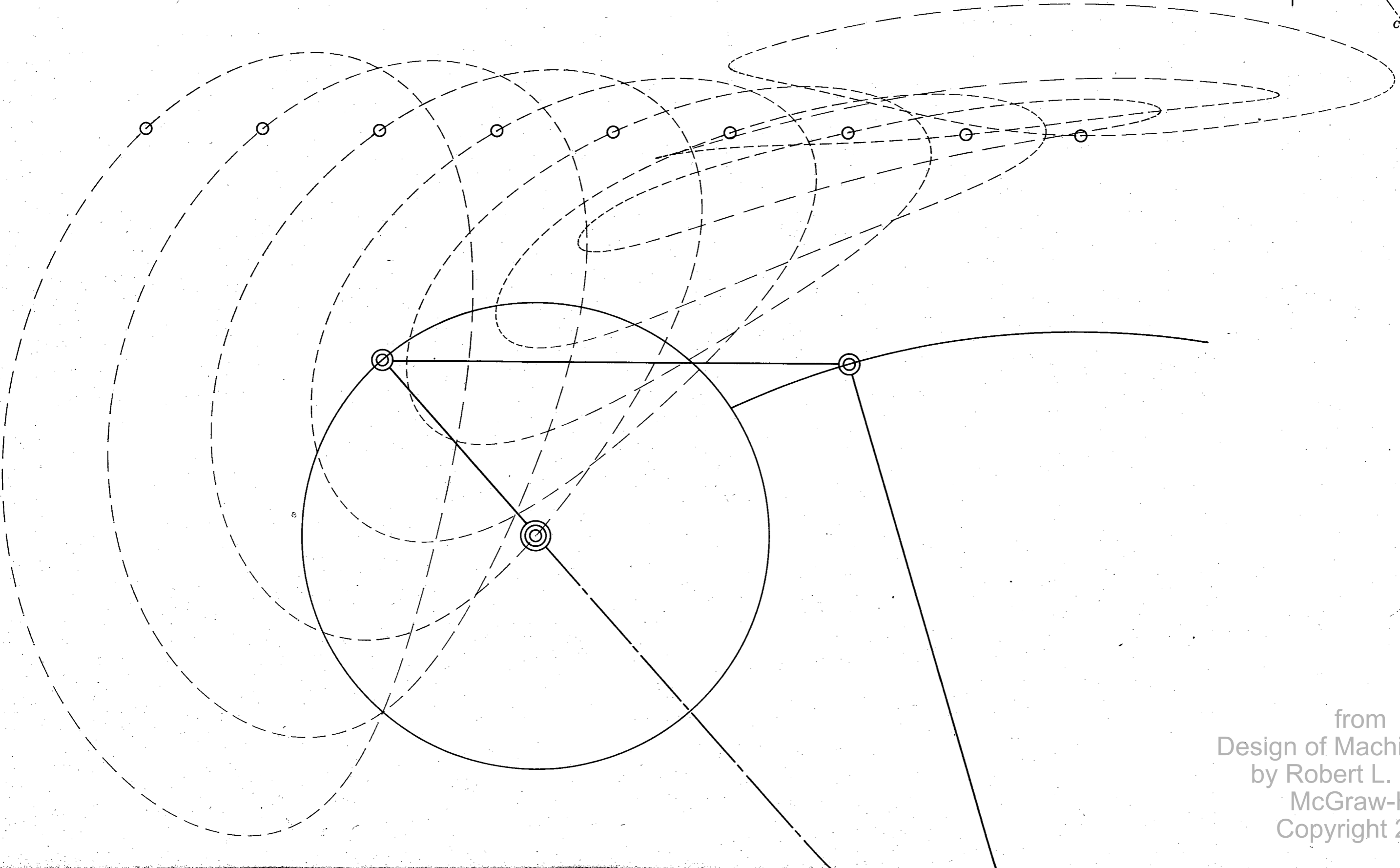

from  
Design of Machinery 4ed  
by Robert L. Norton  
McGraw-Hill  
Copyright 2008

**Analysis of the Four Bar Linkage**

*J. A. Hrones and G. L. Nelson*

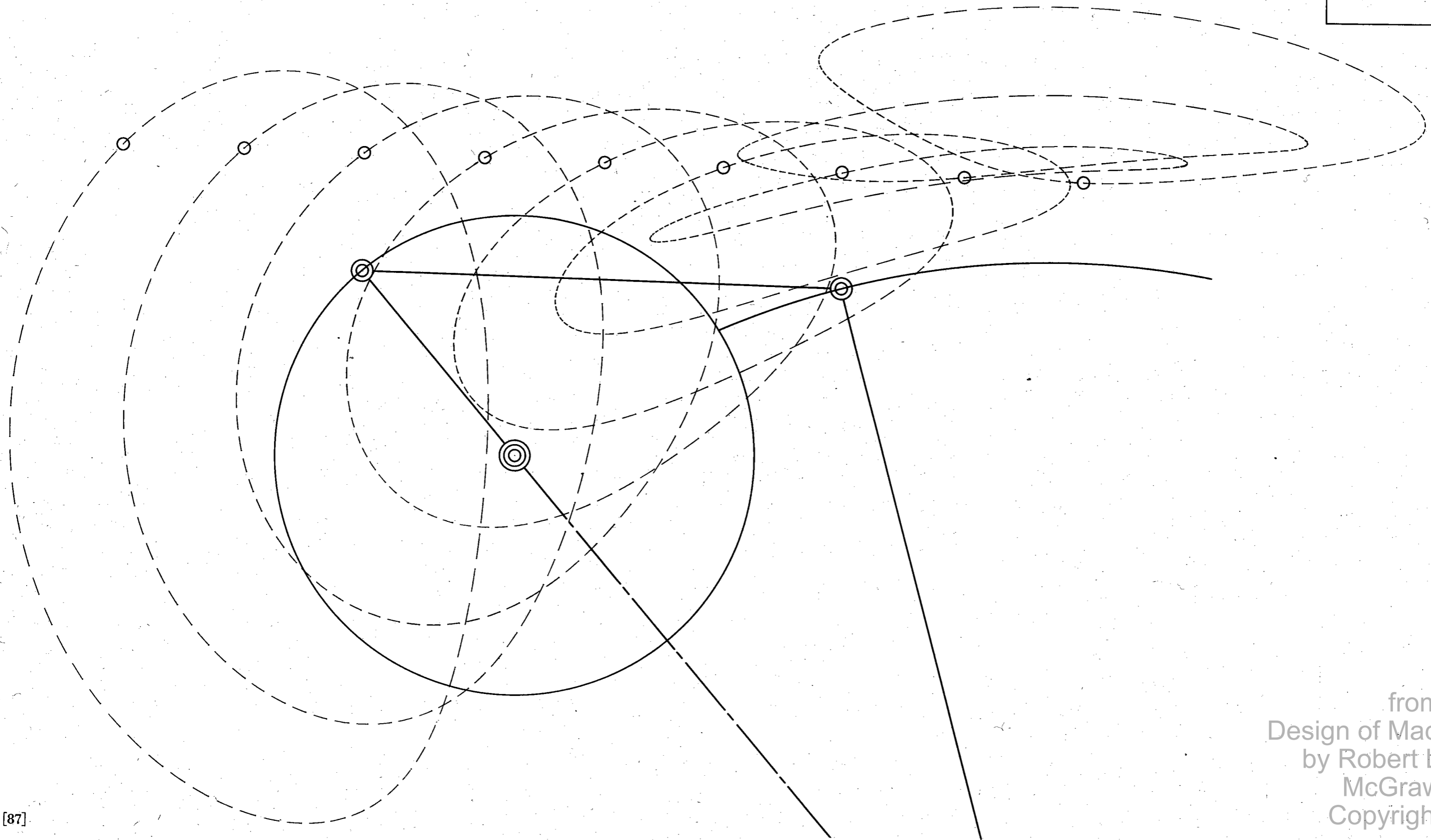
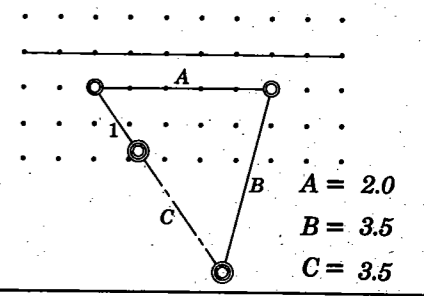

from  
Design of Machinery 4ed  
by Robert L. Norton  
McGraw-Hill  
Copyright 2008

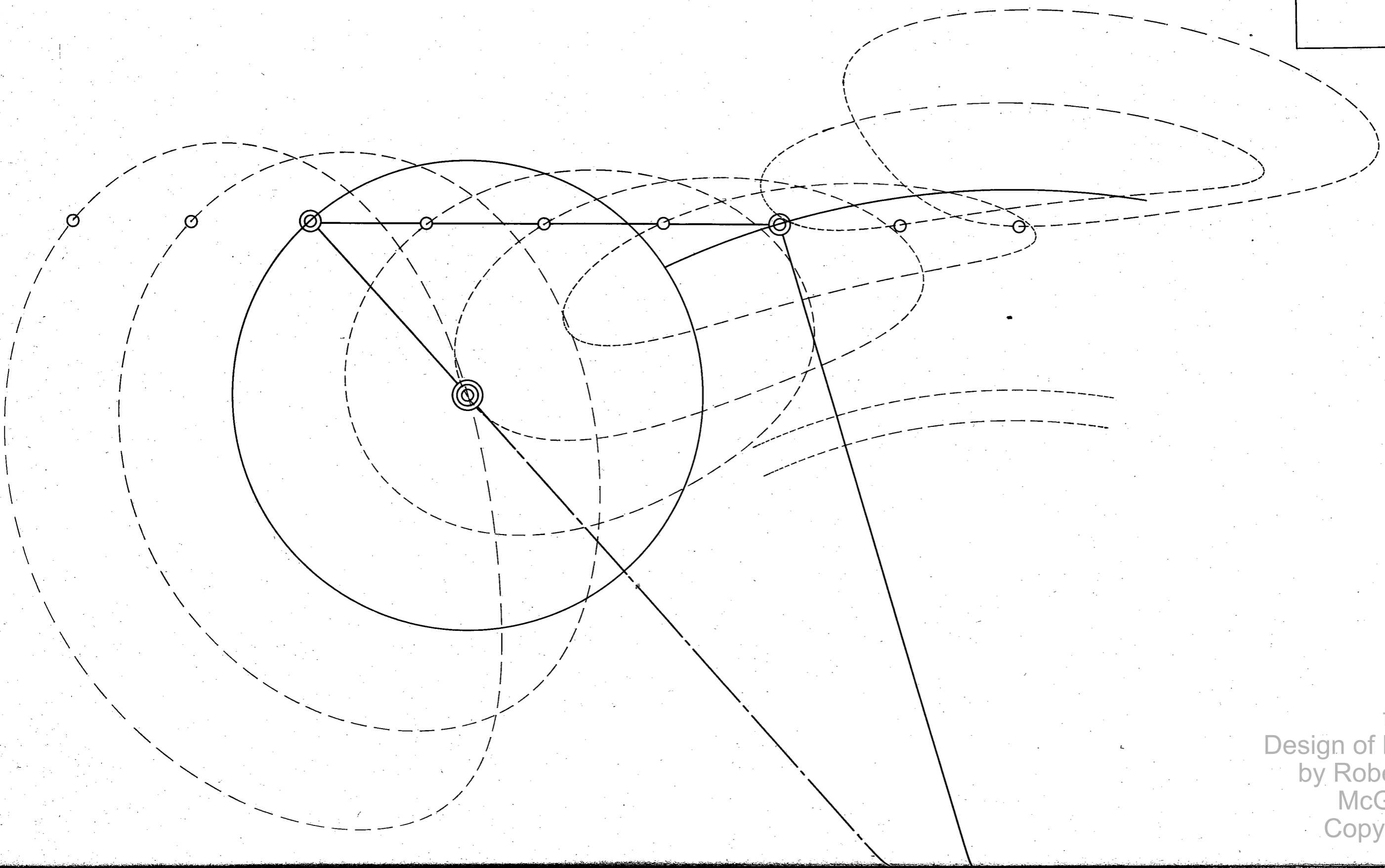
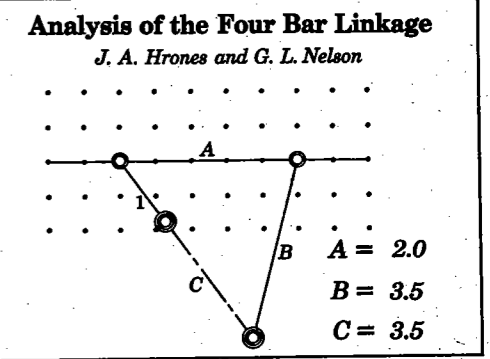

from  
Design of Machinery 4ed  
by Robert L. Norton  
McGraw-Hill  
Copyright 2008

**Analysis of the Four Bar Linkage**

*J. A. Hrones and G. L. Nelson*

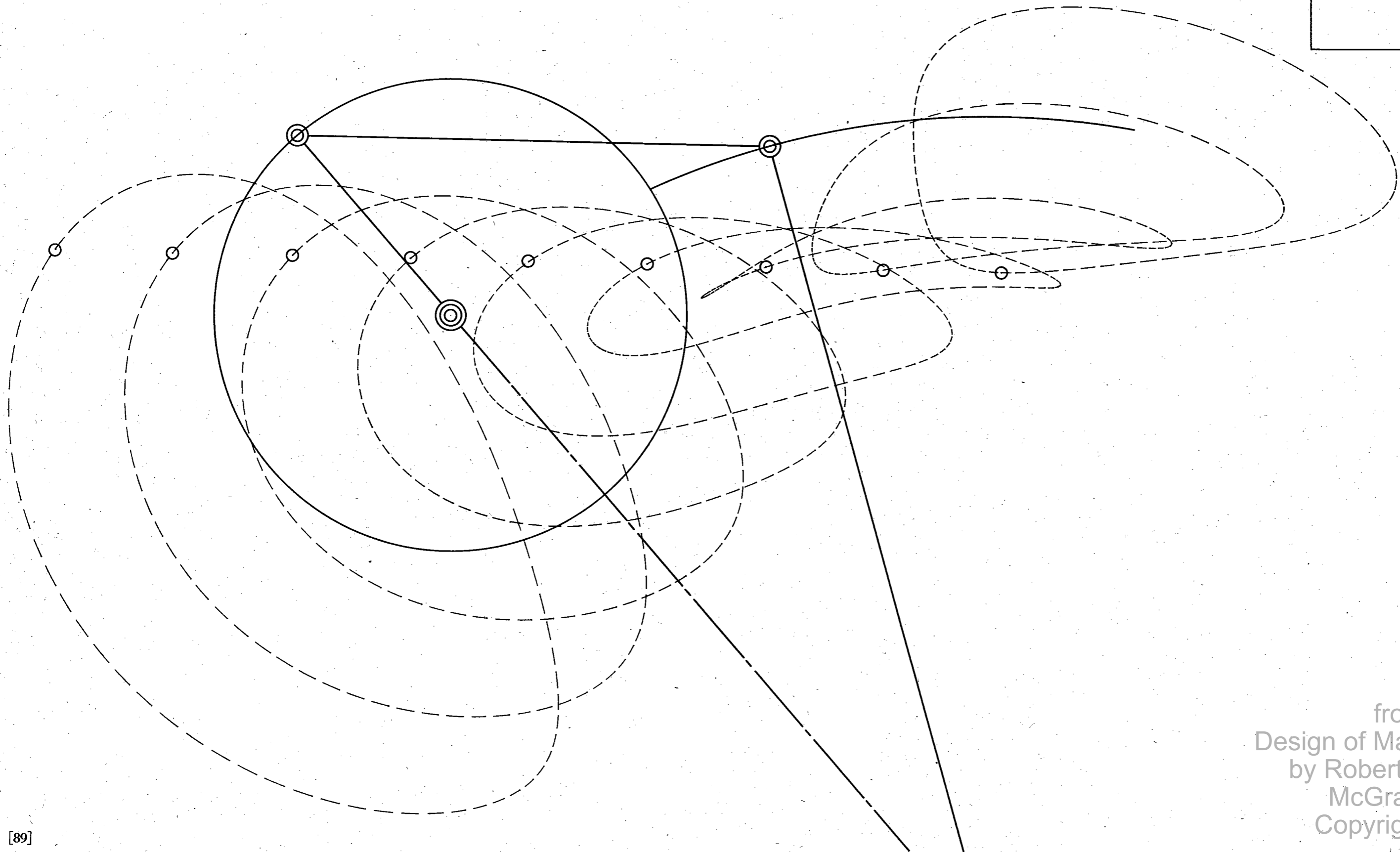
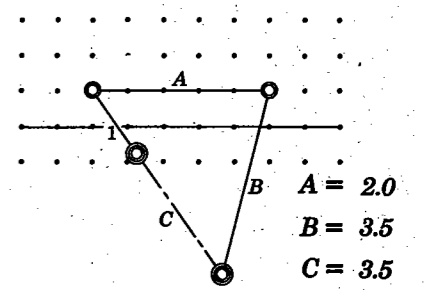

from  
Design of Machinery 4ed  
by Robert L. Norton  
McGraw-Hill  
Copyright 2008



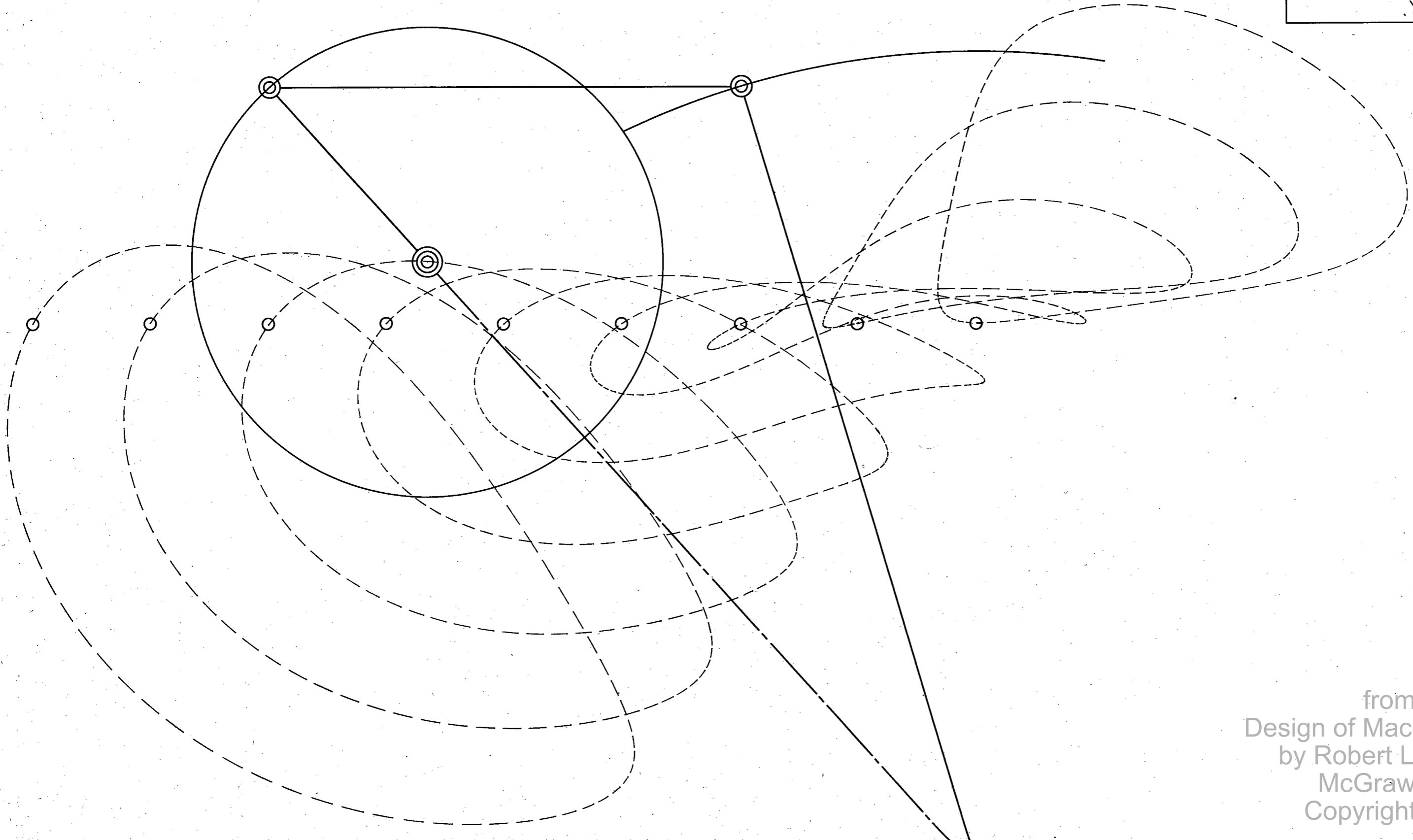
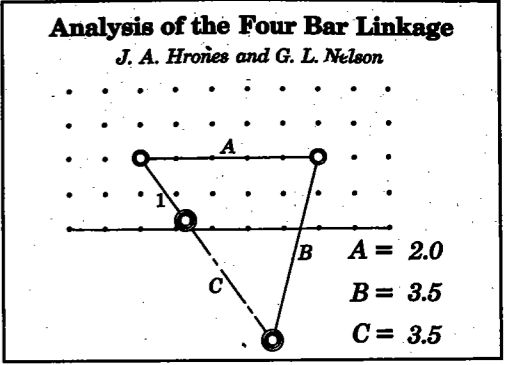

from  
Design of Machinery 4ed  
by Robert L. Norton  
McGraw-Hill  
Copyright 2008

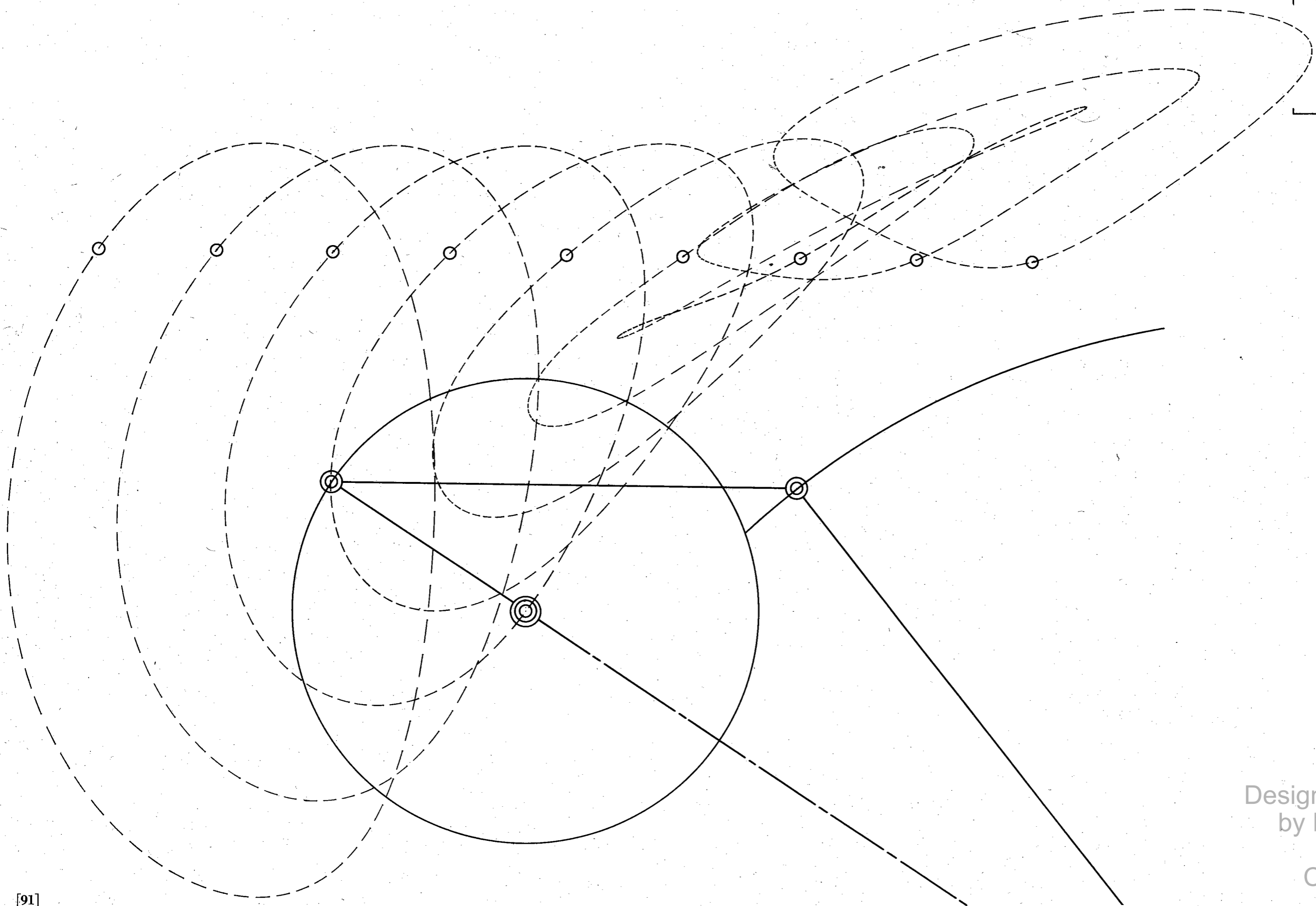
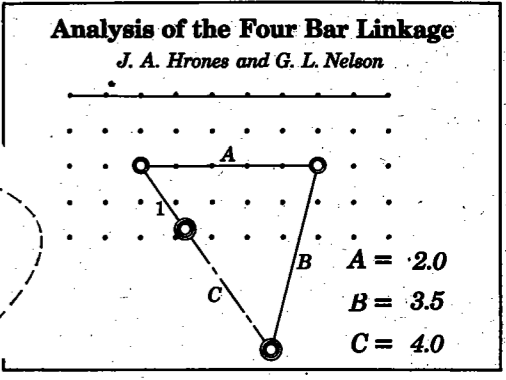

from  
 Design of Machinery 4ed  
 by Robert L. Norton  
 McGraw-Hill  
 Copyright 2008

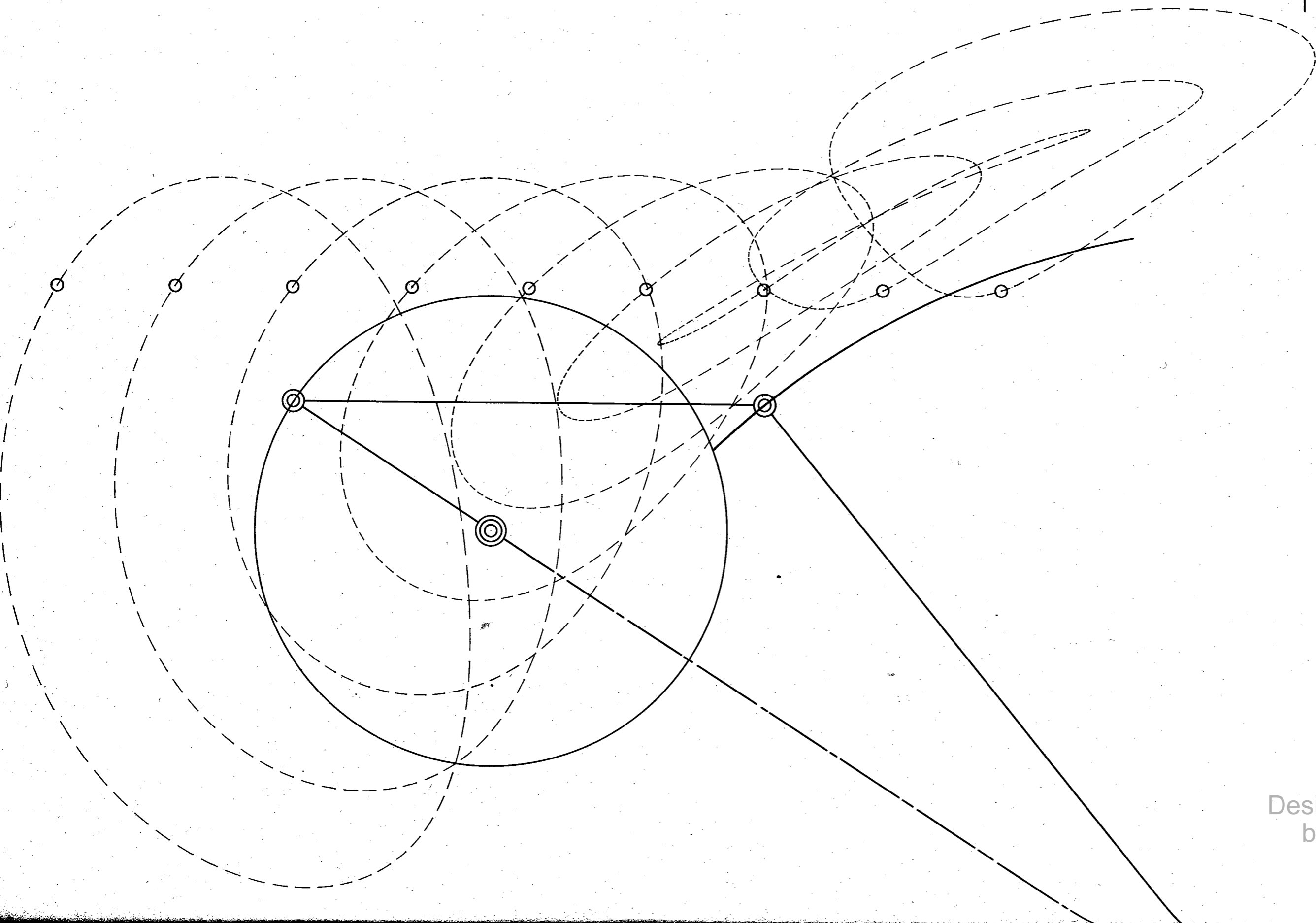
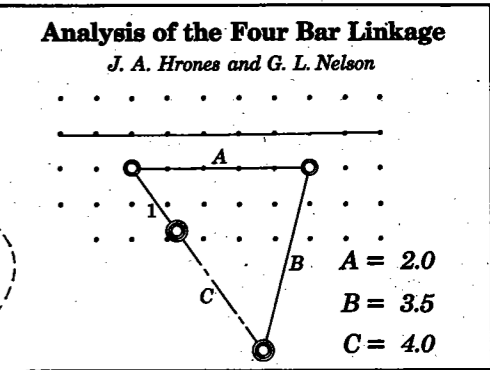

from  
Design of Machinery 4ed  
by Robert L. Norton  
McGraw-Hill  
Copyright 2008

**Analysis of the Four Bar Linkage**  
*J. A. Hrones and G. L. Nelson.*

$A = 2.0$   
 $B = 3.5$   
 $C = 4.0$

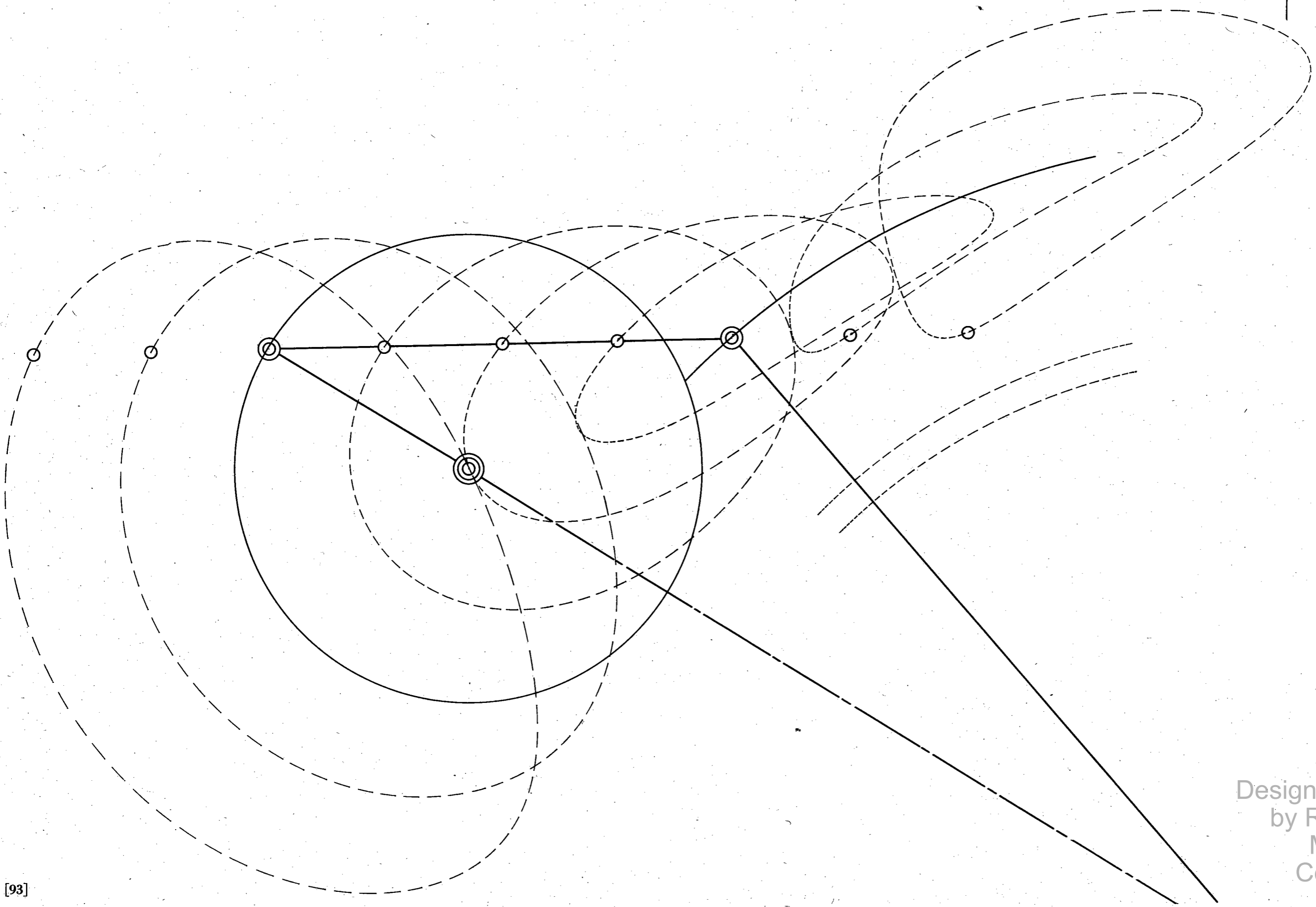

from  
 Design of Machinery 4ed  
 by Robert L. Norton  
 McGraw-Hill  
 Copyright 2008

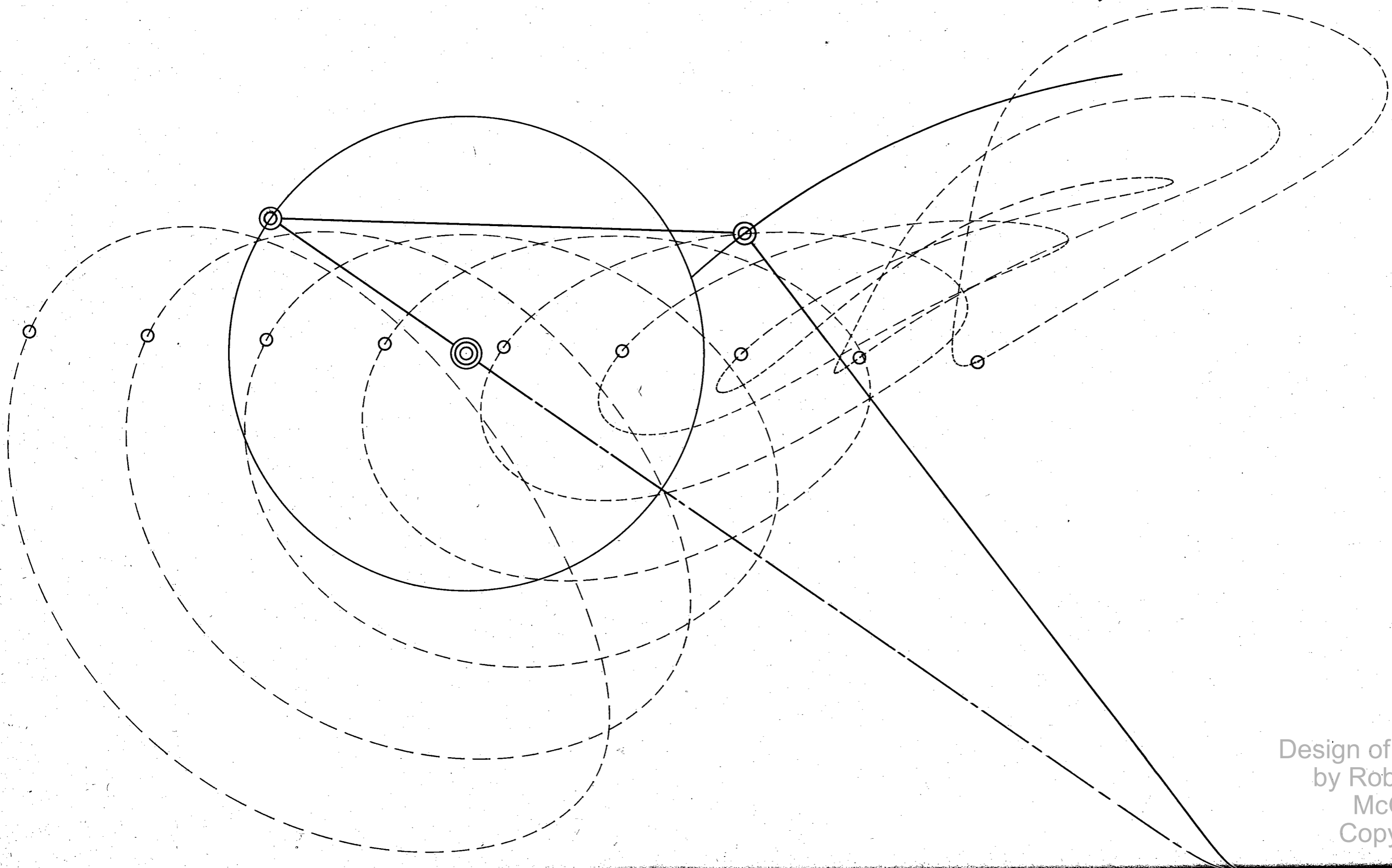
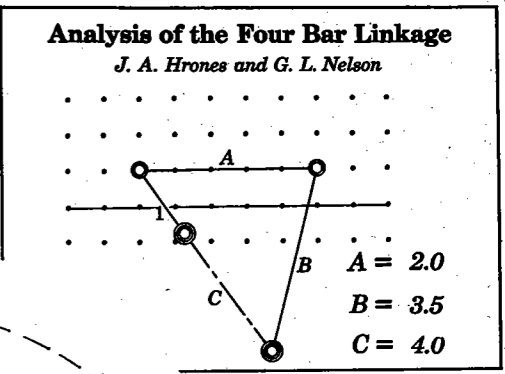

from  
Design of Machinery 4ed  
by Robert L. Norton  
McGraw-Hill  
Copyright 2008

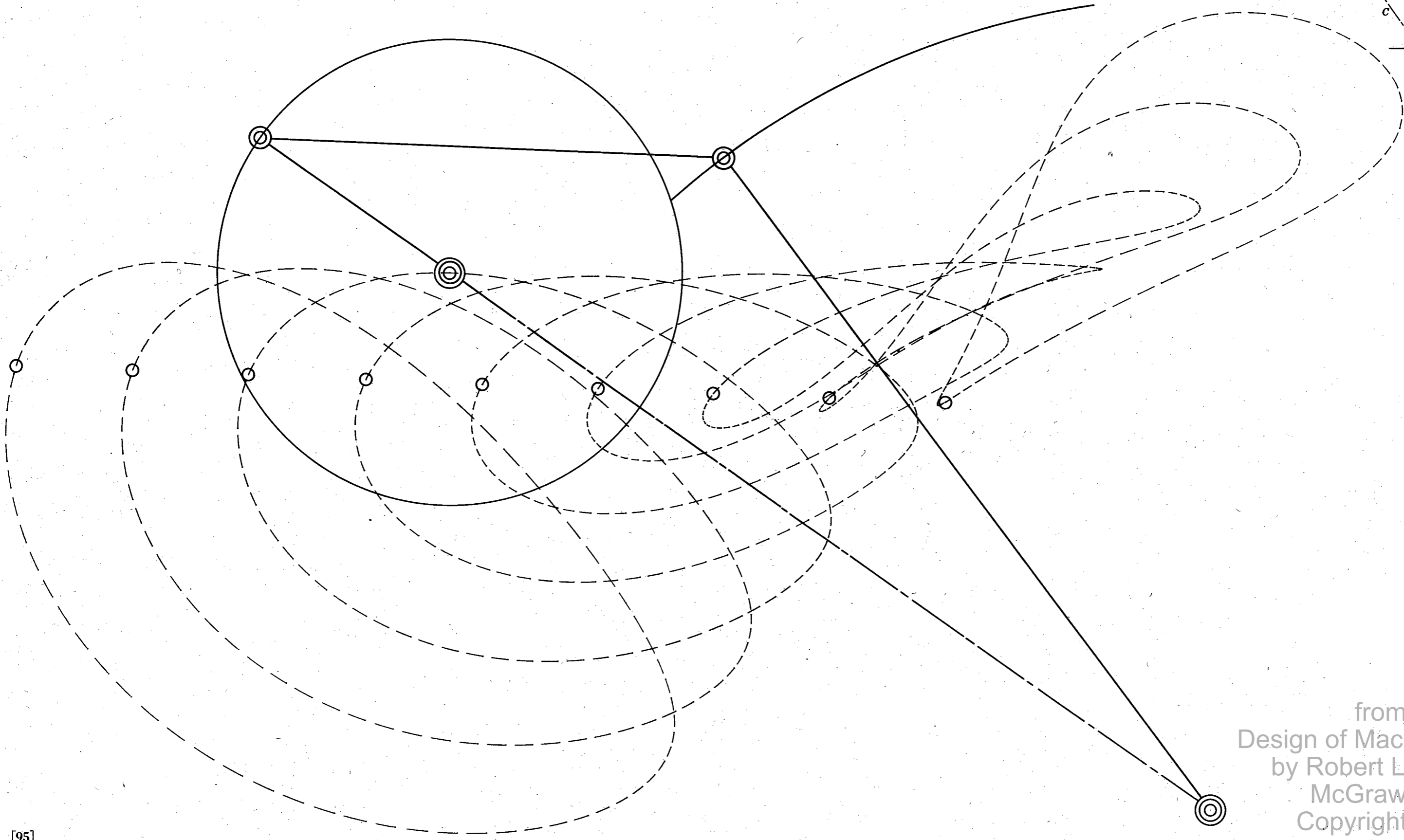
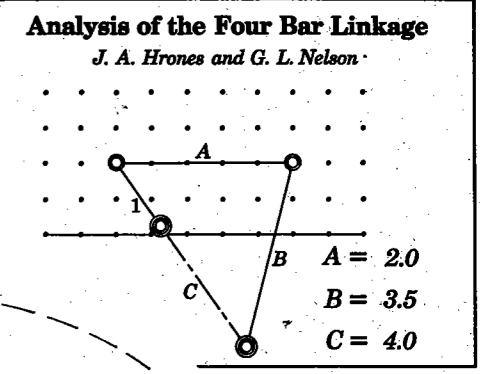

from  
 Design of Machinery 4ed  
 by Robert L. Norton  
 McGraw-Hill  
 Copyright 2008

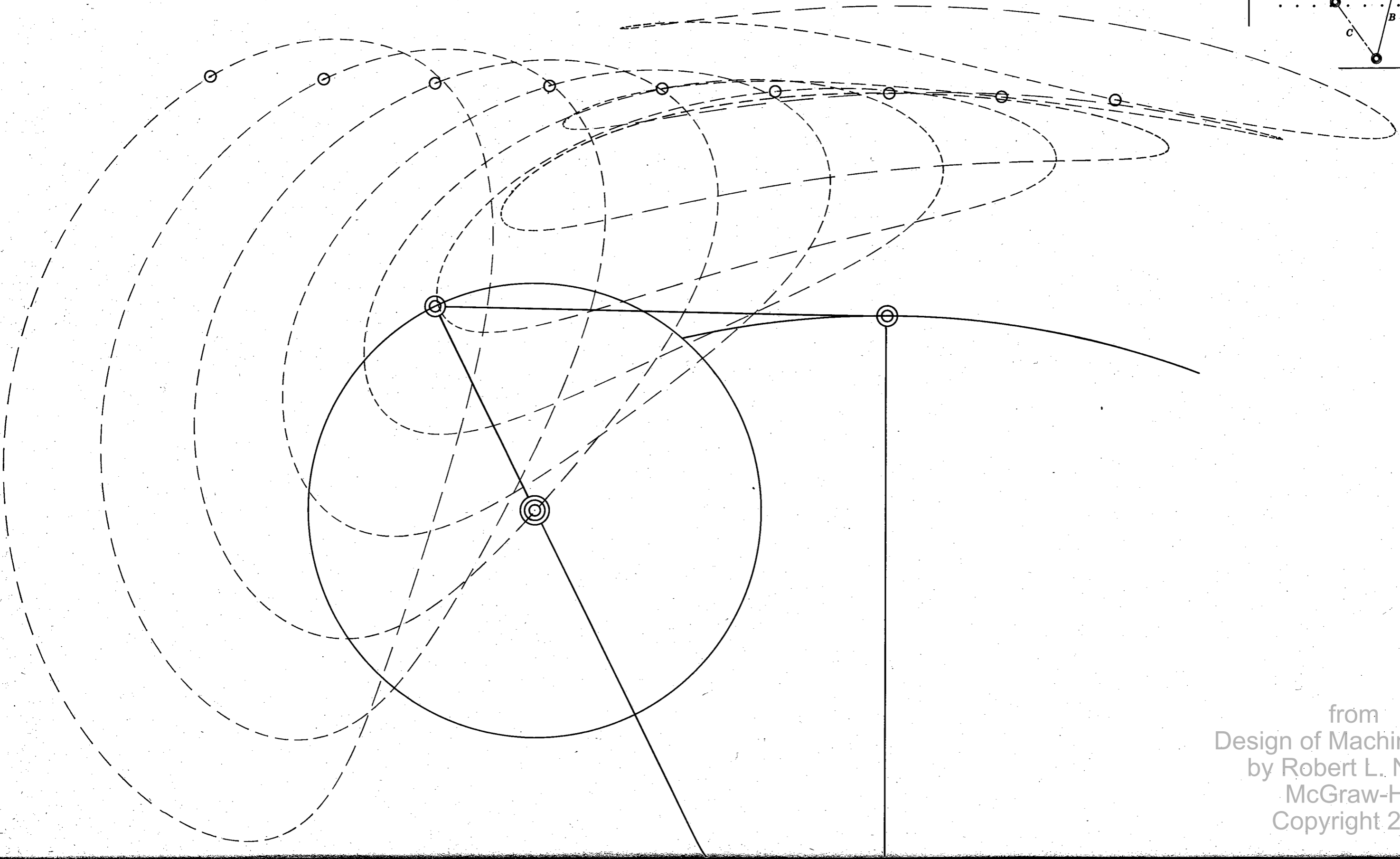
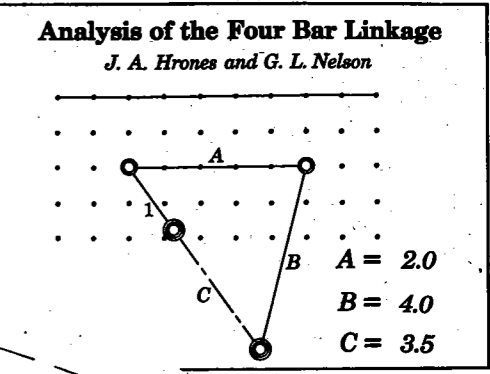

from  
Design of Machinery 4ed  
by Robert L. Norton  
McGraw-Hill  
Copyright 2008

**Analysis of the Four Bar Linkage**

*J. A. Hrones and G. L. Nelson*

.....

.....

.....

.....

.....

.....

.....

.....

.....

.....

.....

.....

.....

.....

.....

.....

.....

.....

.....

.....

.....

.....

.....

.....

.....

.....

.....

.....

.....

.....

.....

.....

.....

.....

.....

.....

.....

.....

.....

.....

.....

.....

.....

.....

.....

.....

.....

.....

.....

.....

.....

.....

.....

.....

.....

.....

A = 2.0  
B = 4.0  
C = 3.5

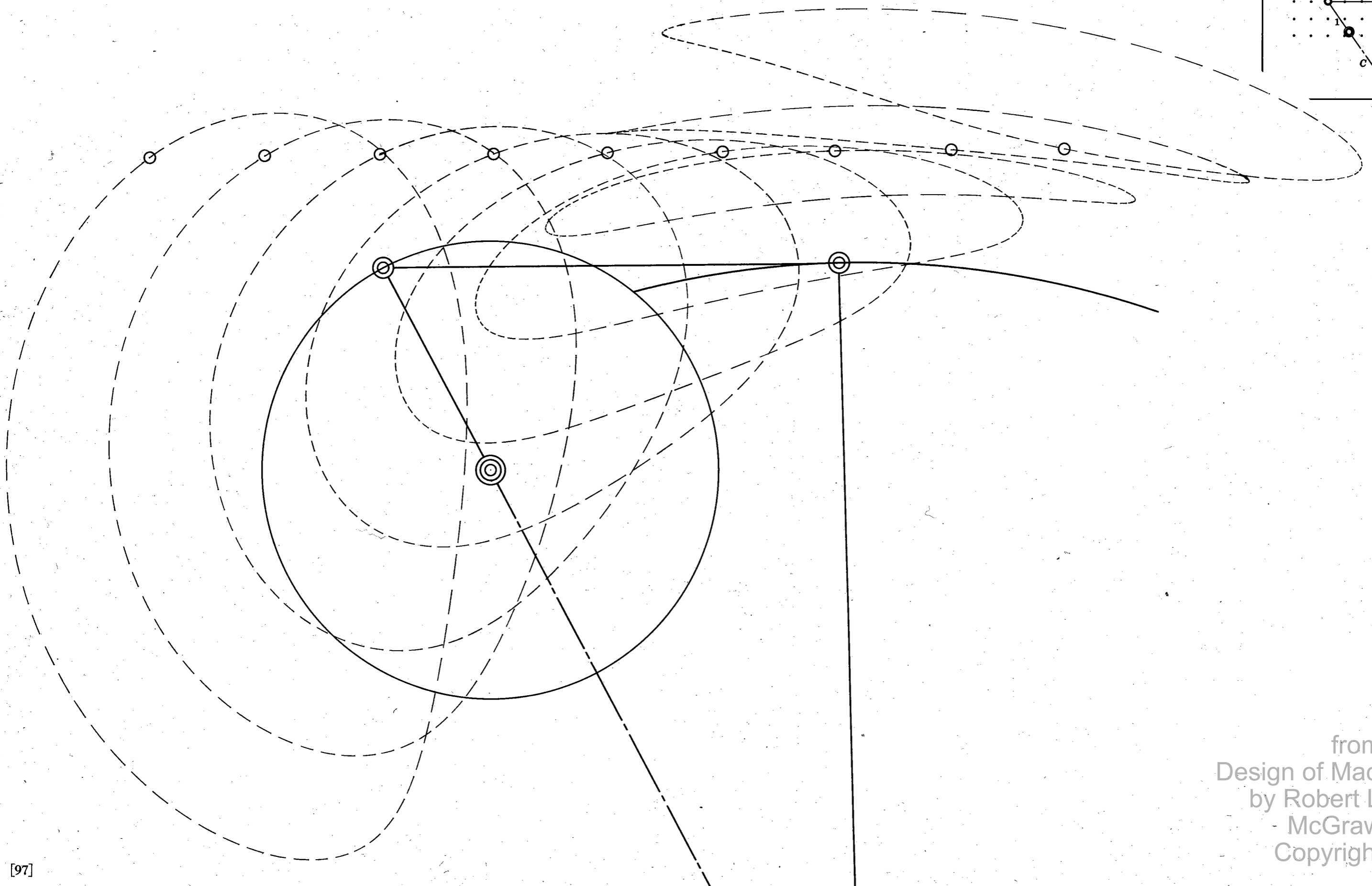

from  
Design of Machinery 4ed  
by Robert L. Norton  
McGraw-Hill  
Copyright 2008



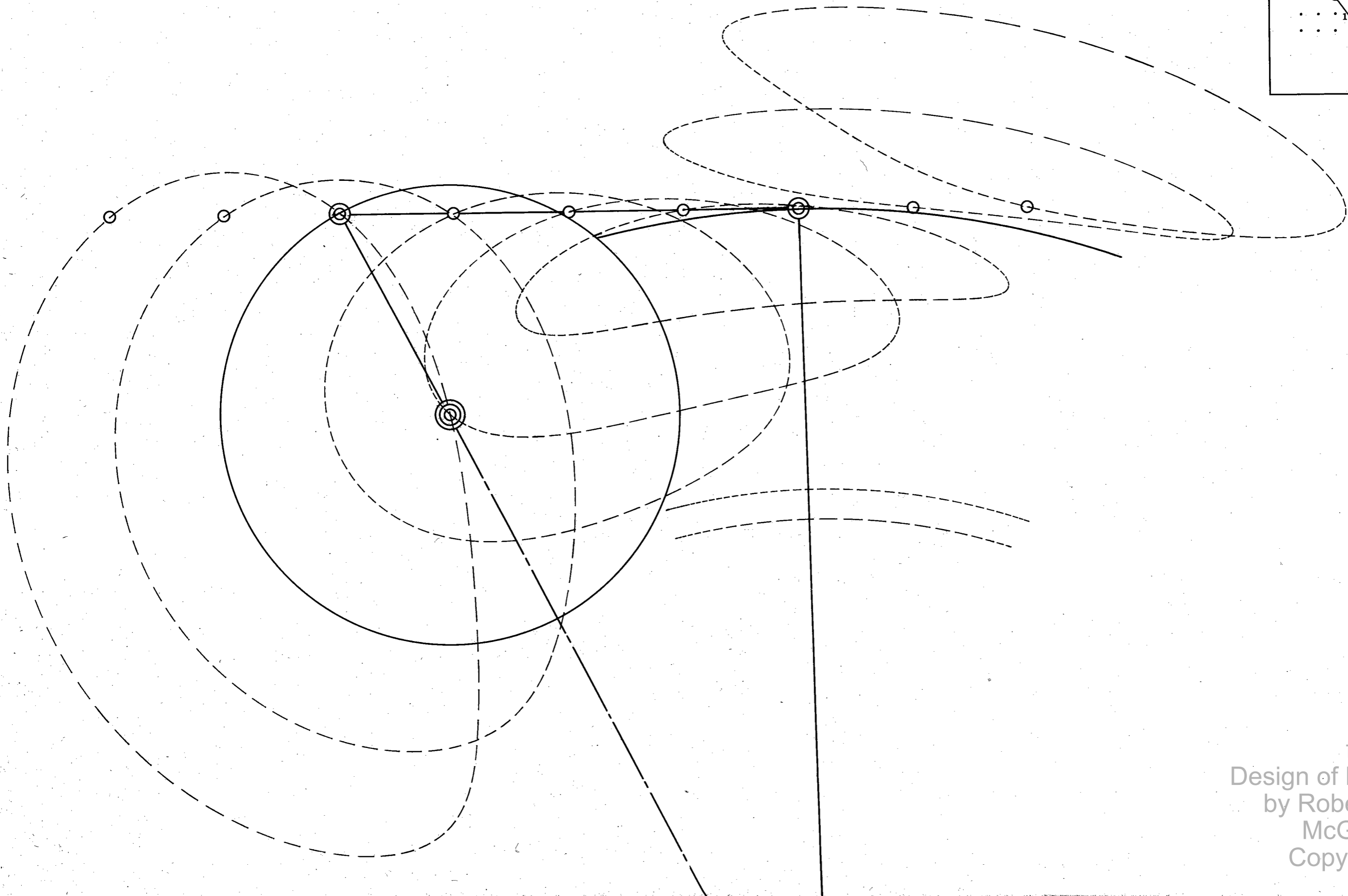
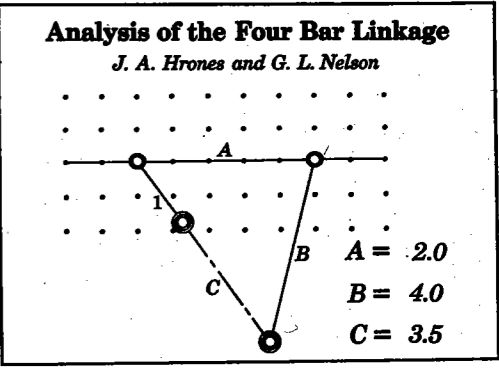

from  
Design of Machinery 4ed  
by Robert L. Norton  
McGraw-Hill  
Copyright 2008

**Analysis of the Four Bar Linkage**

*J. A. Hrones and G. L. Nelson*

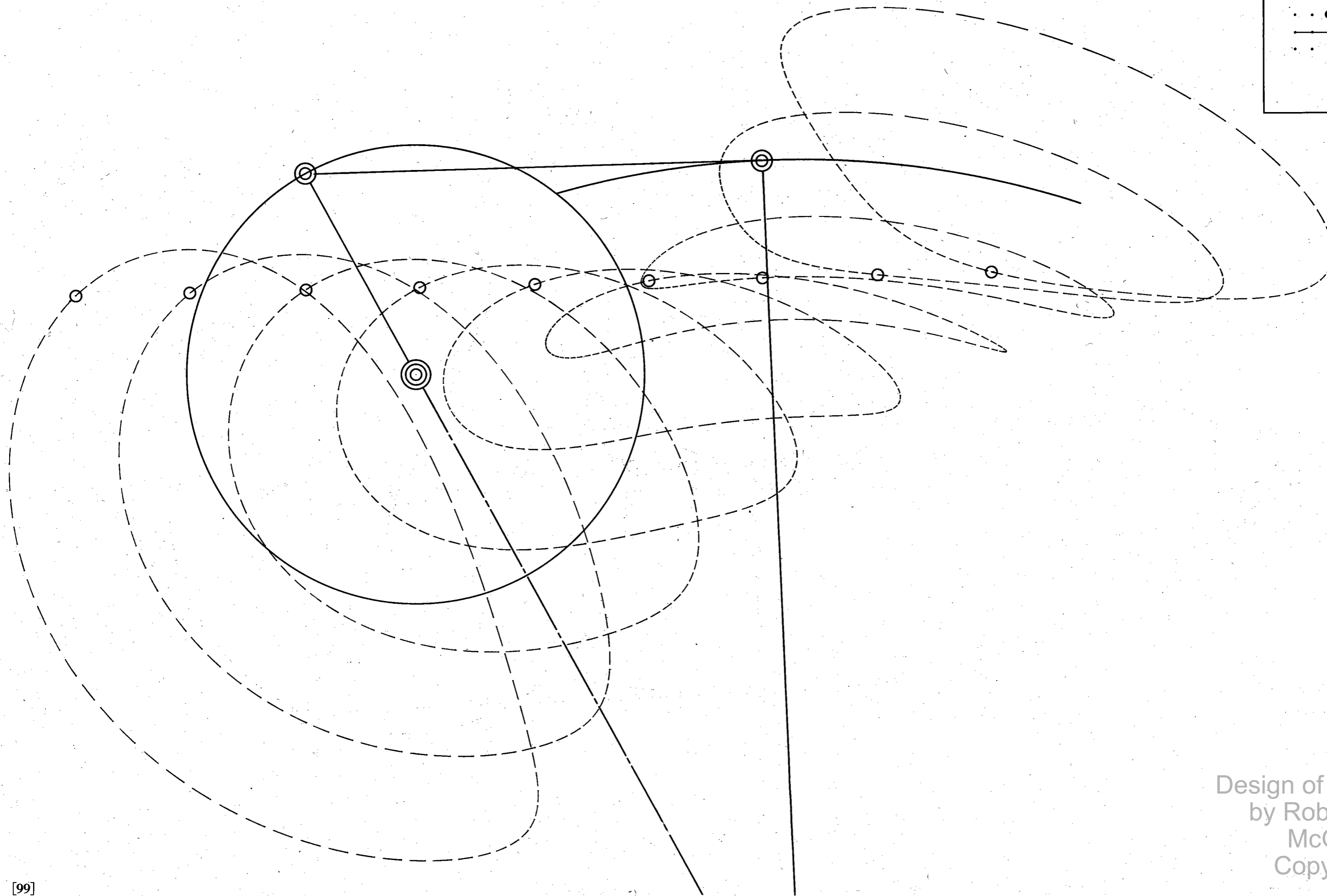
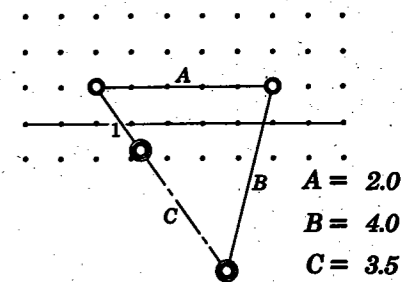

from  
Design of Machinery 4ed  
by Robert L. Norton  
McGraw-Hill  
Copyright 2008

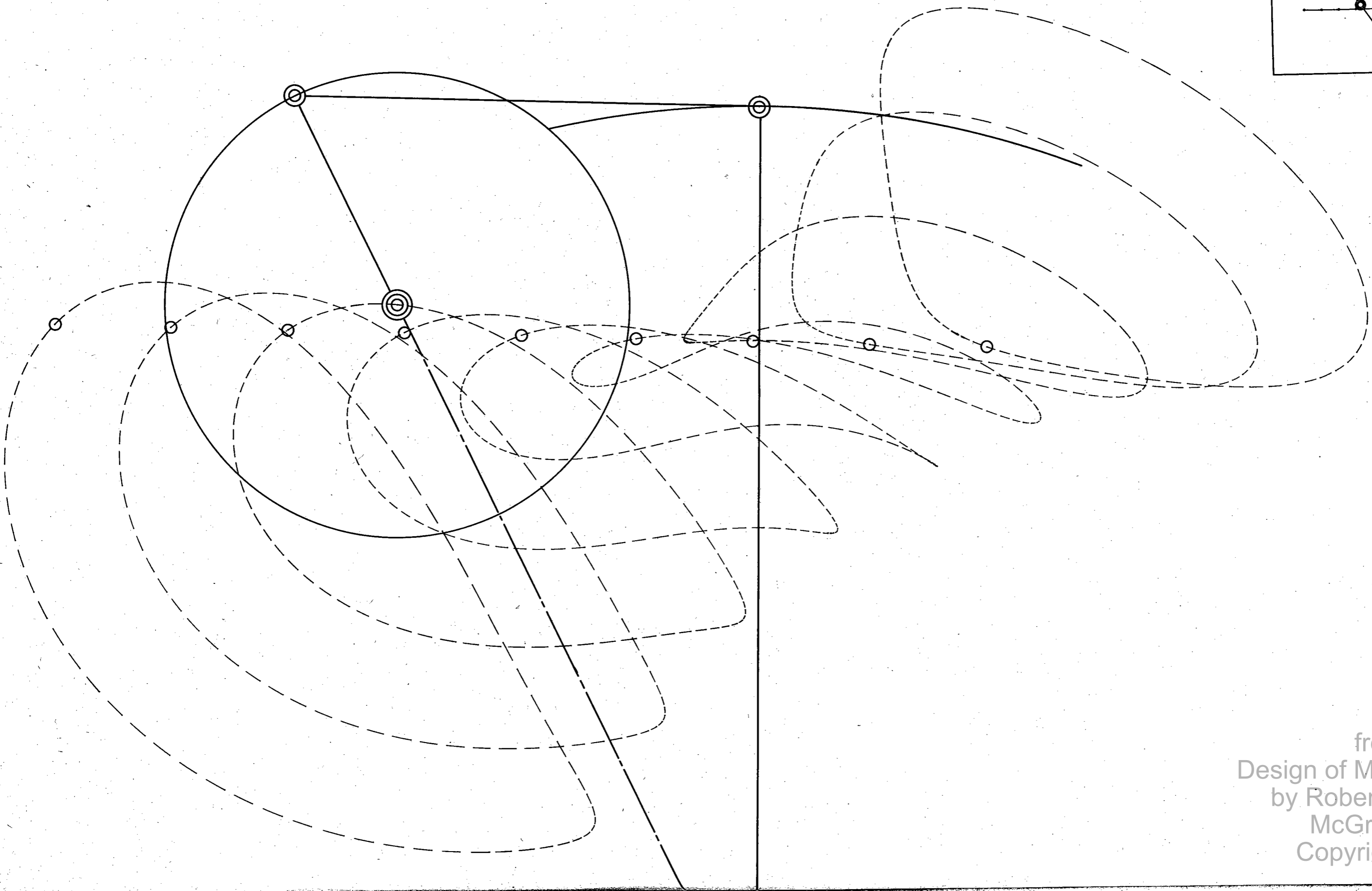
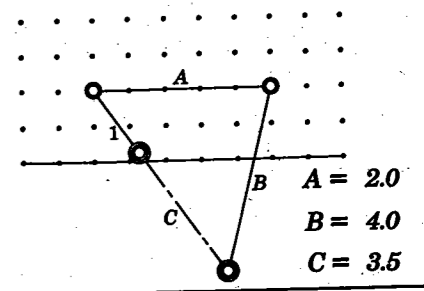

from  
Design of Machinery 4ed  
by Robert L. Norton  
McGraw-Hill  
Copyright 2008

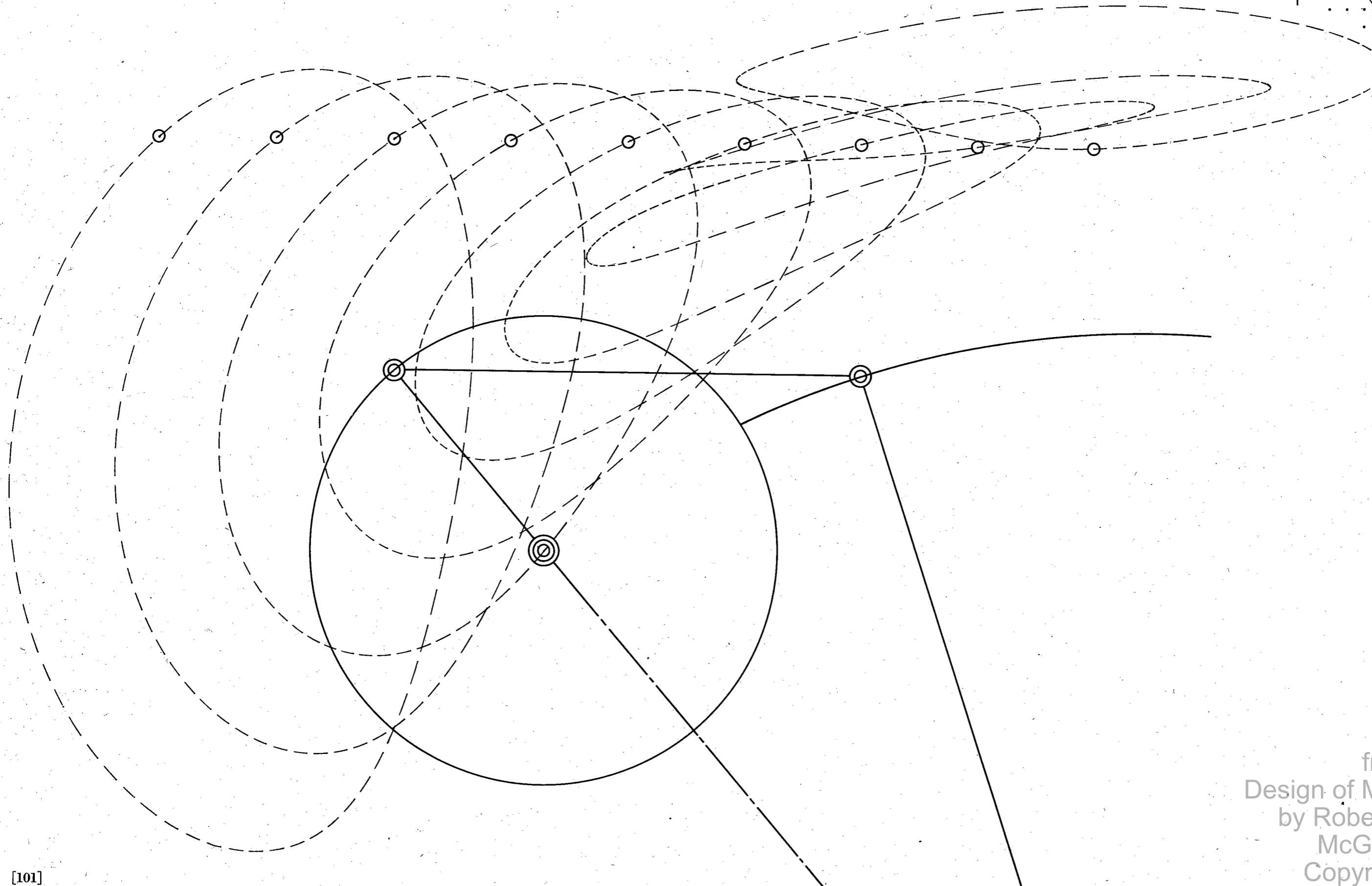
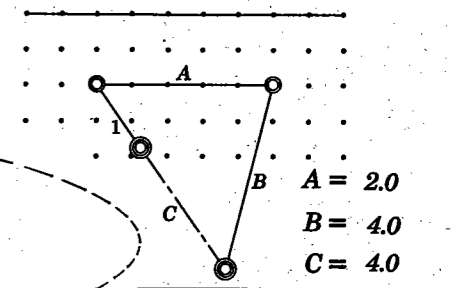

from  
Design of Machinery 4ed  
by Robert L. Norton  
McGraw-Hill  
Copyright 2008

**Analysis of the Four Bar Linkage**  
*J. A. Hrones and G. L. Nelson*

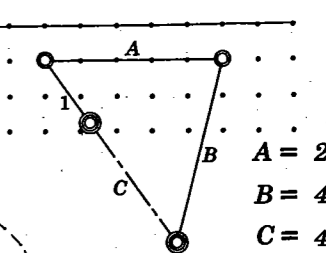

$A = 2.0$   
 $B = 4.0$   
 $C = 4.0$

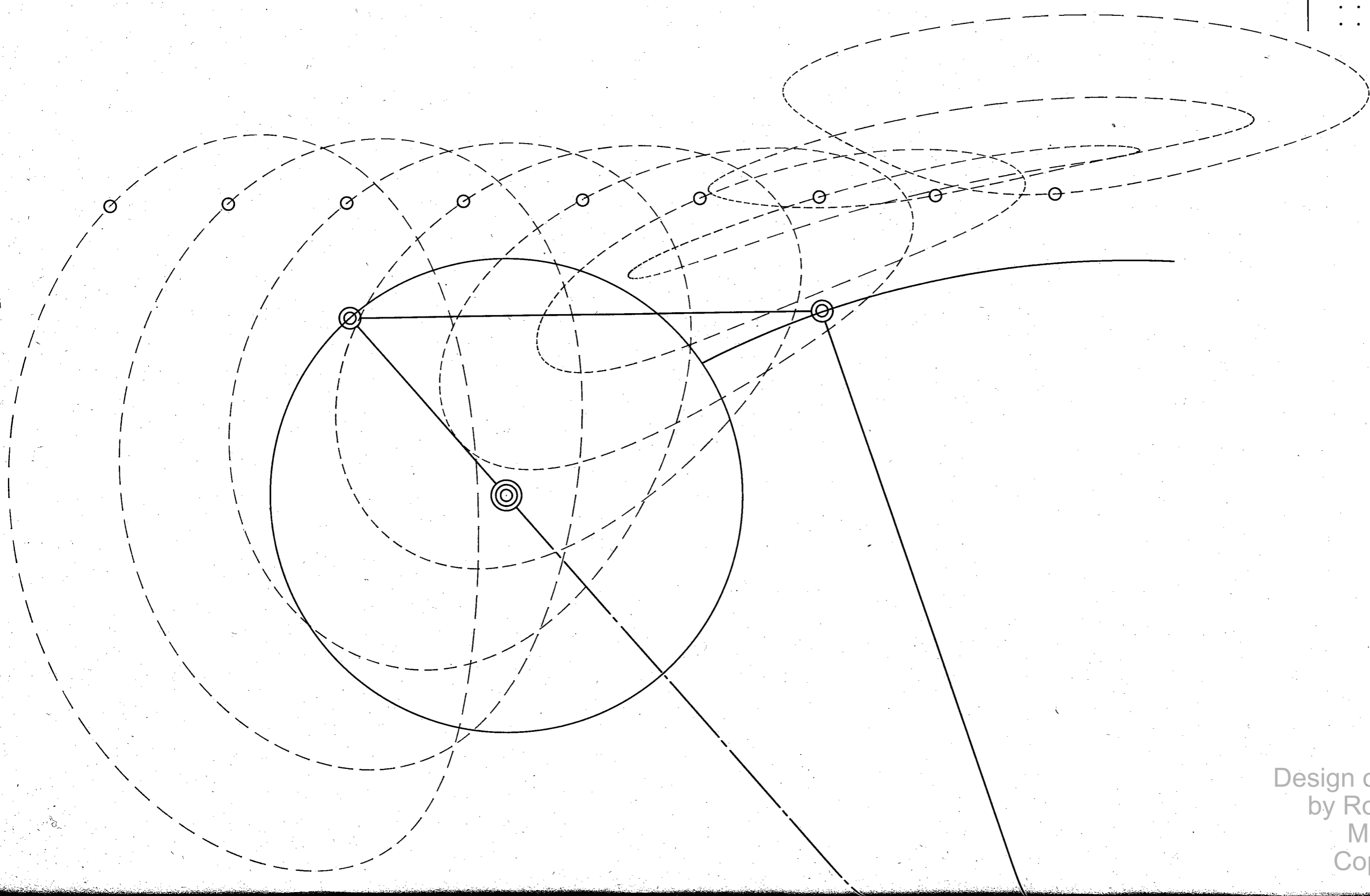

from  
Design of Machinery 4ed  
by Robert L. Norton  
McGraw-Hill  
Copyright 2008

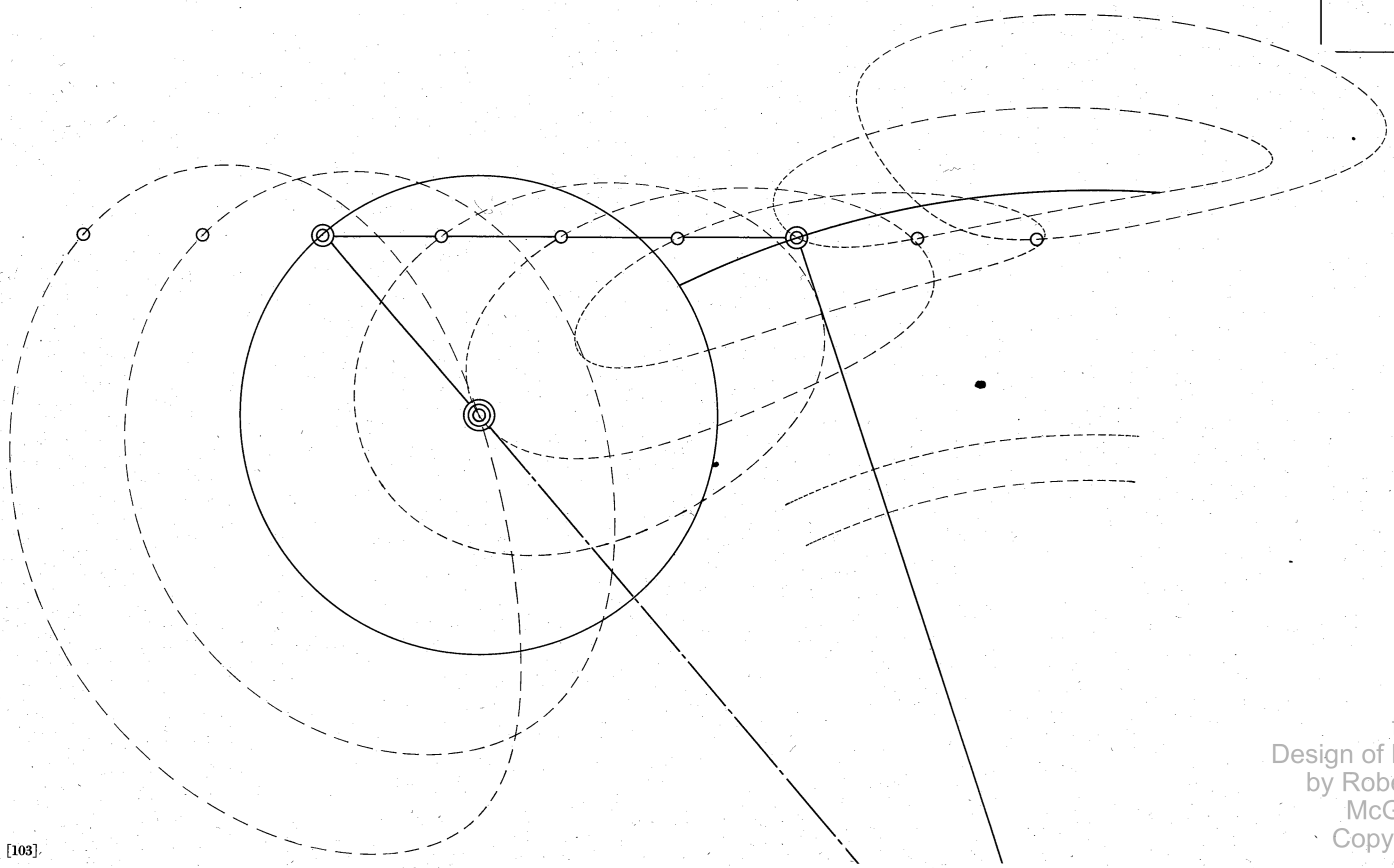
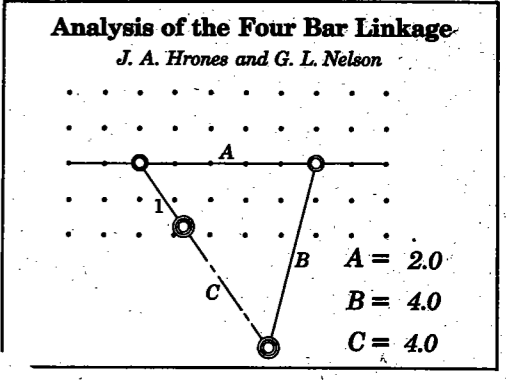

from  
 Design of Machinery 4ed  
 by Robert L. Norton  
 McGraw-Hill  
 Copyright 2008

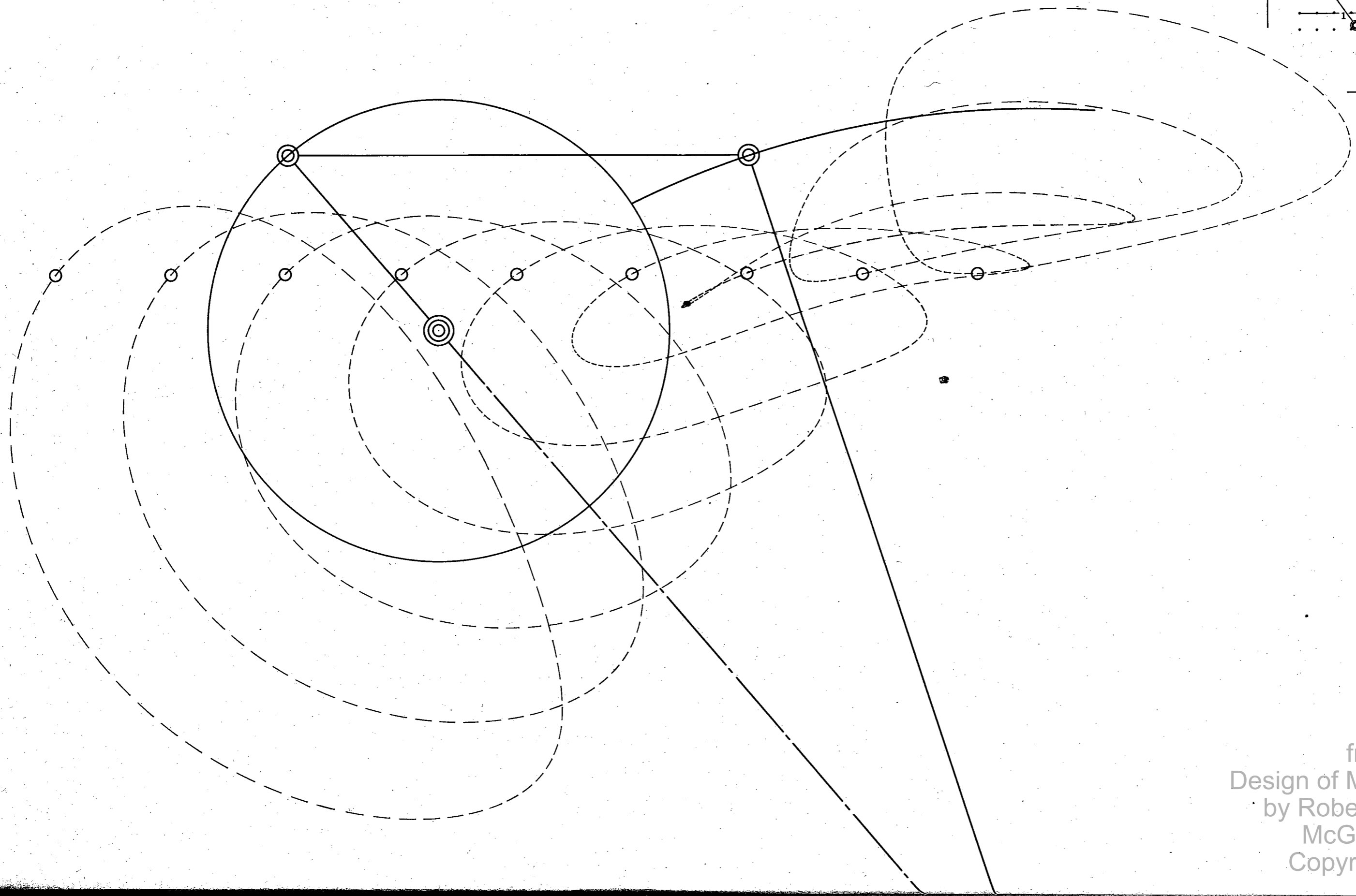
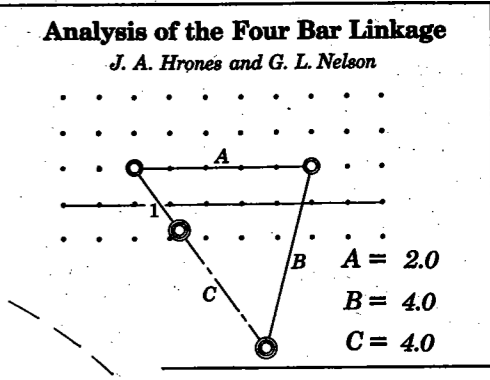

from  
Design of Machinery 4ed  
by Robert L. Norton  
McGraw-Hill  
Copyright 2008

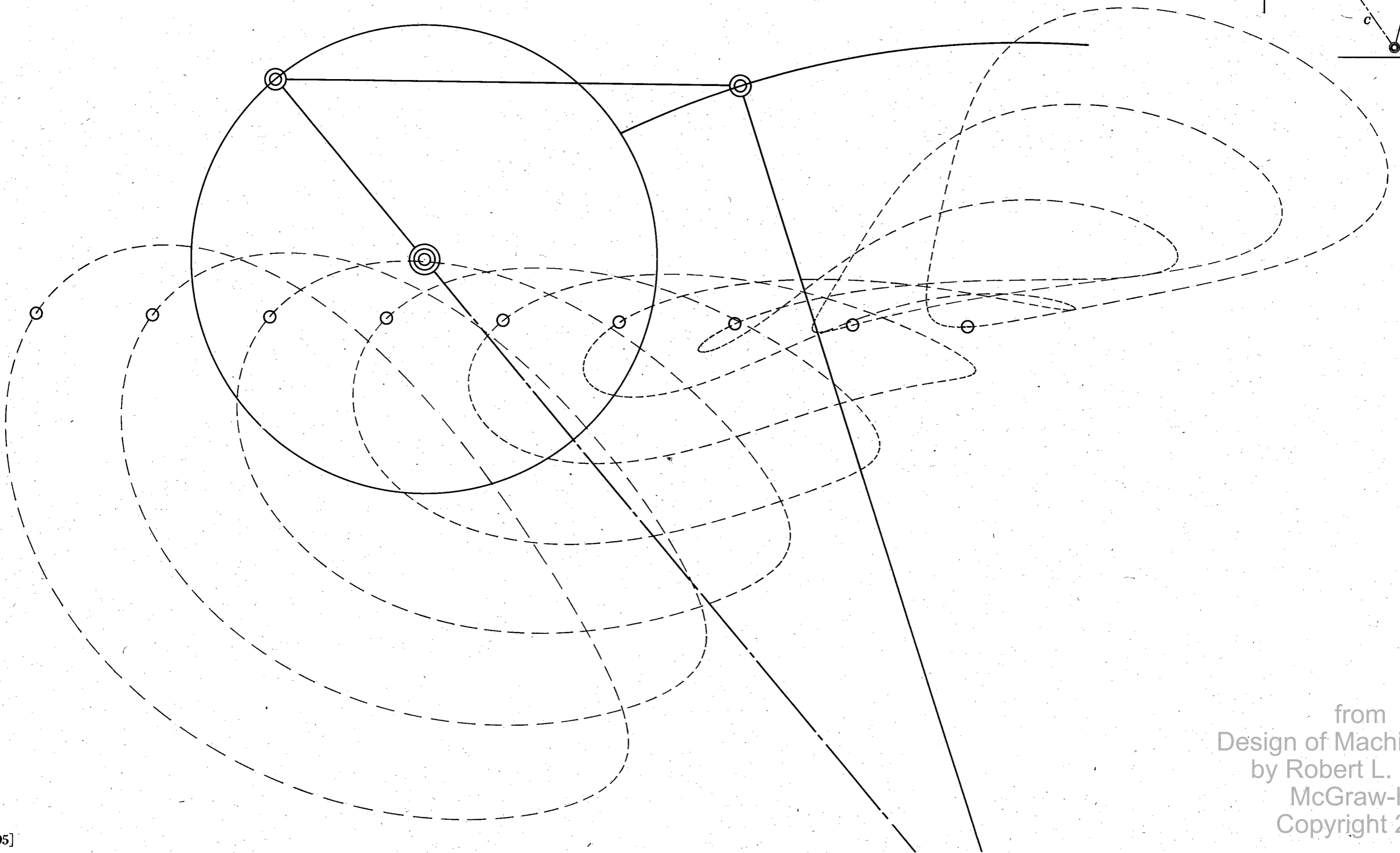
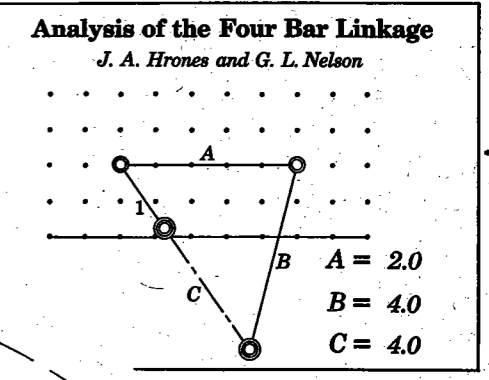

from  
 Design of Machinery 4ed  
 by Robert L. Norton  
 McGraw-Hill  
 Copyright 2008



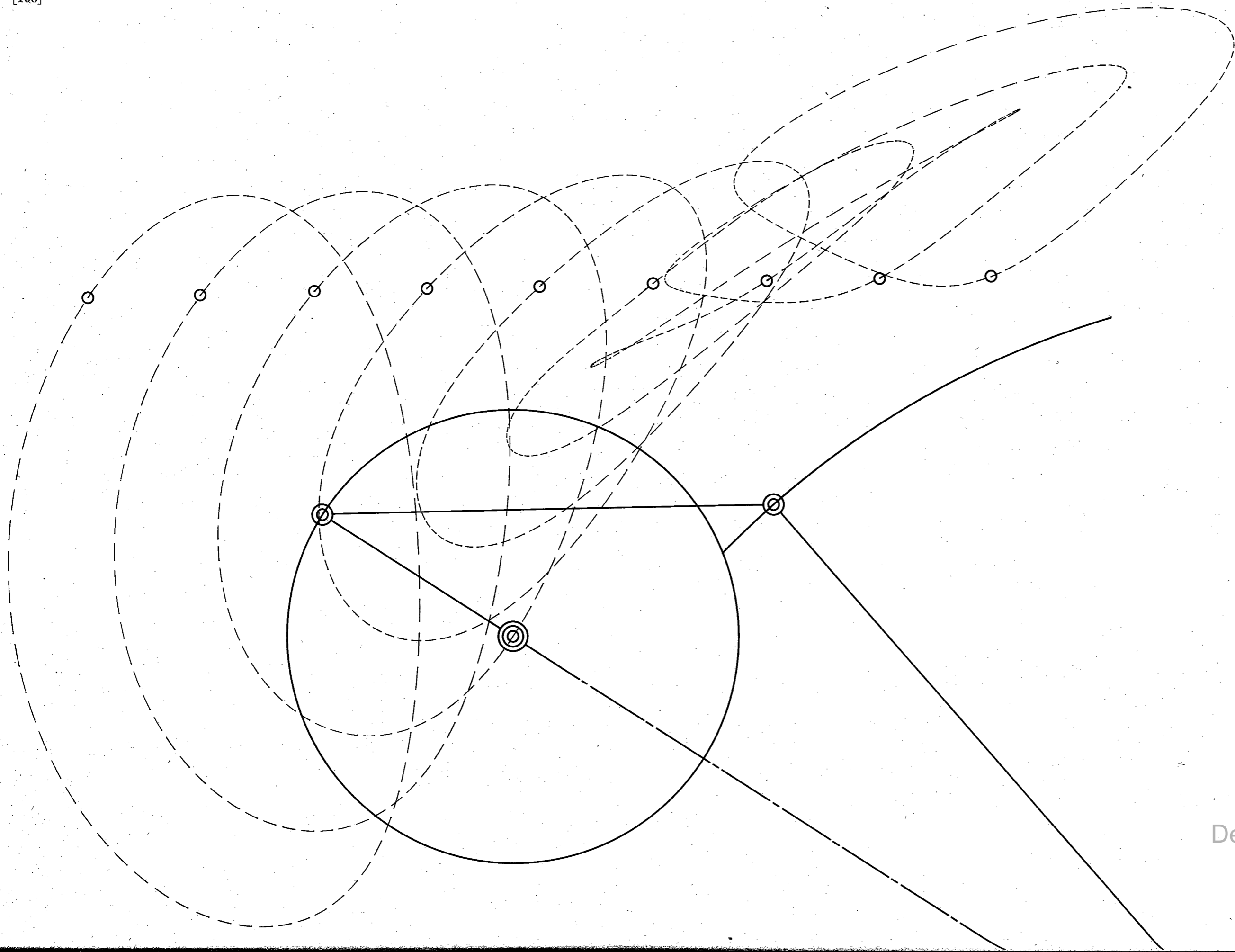
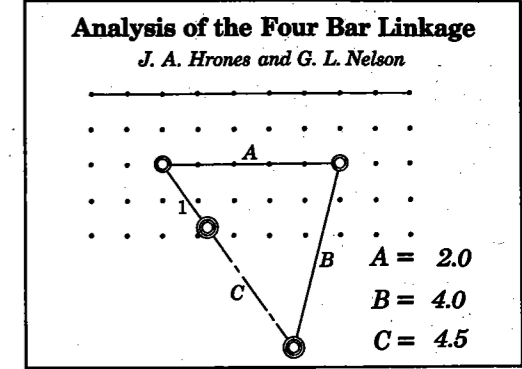

from  
Design of Machinery 4ed  
by Robert L. Norton  
McGraw-Hill  
Copyright 2008

**Analysis of the Four Bar Linkage**

*J. A. Hrones and G. L. Nelson*

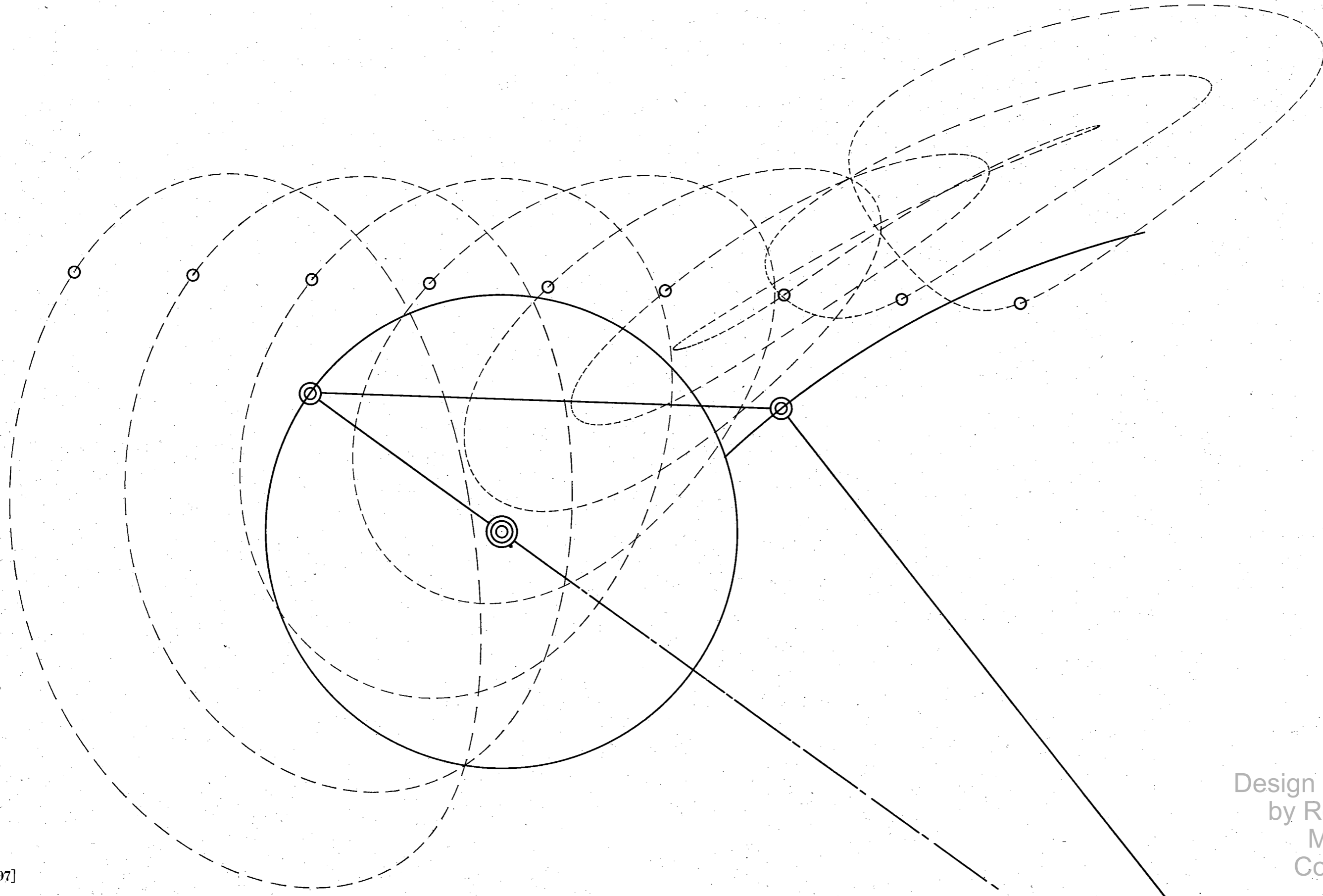
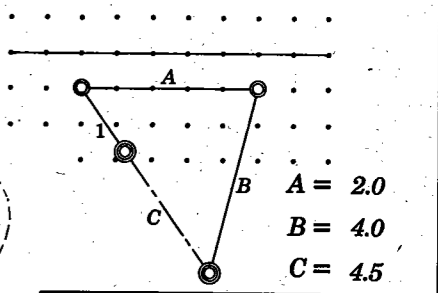

from  
Design of Machinery 4ed  
by Robert L. Norton  
McGraw-Hill  
Copyright 2008

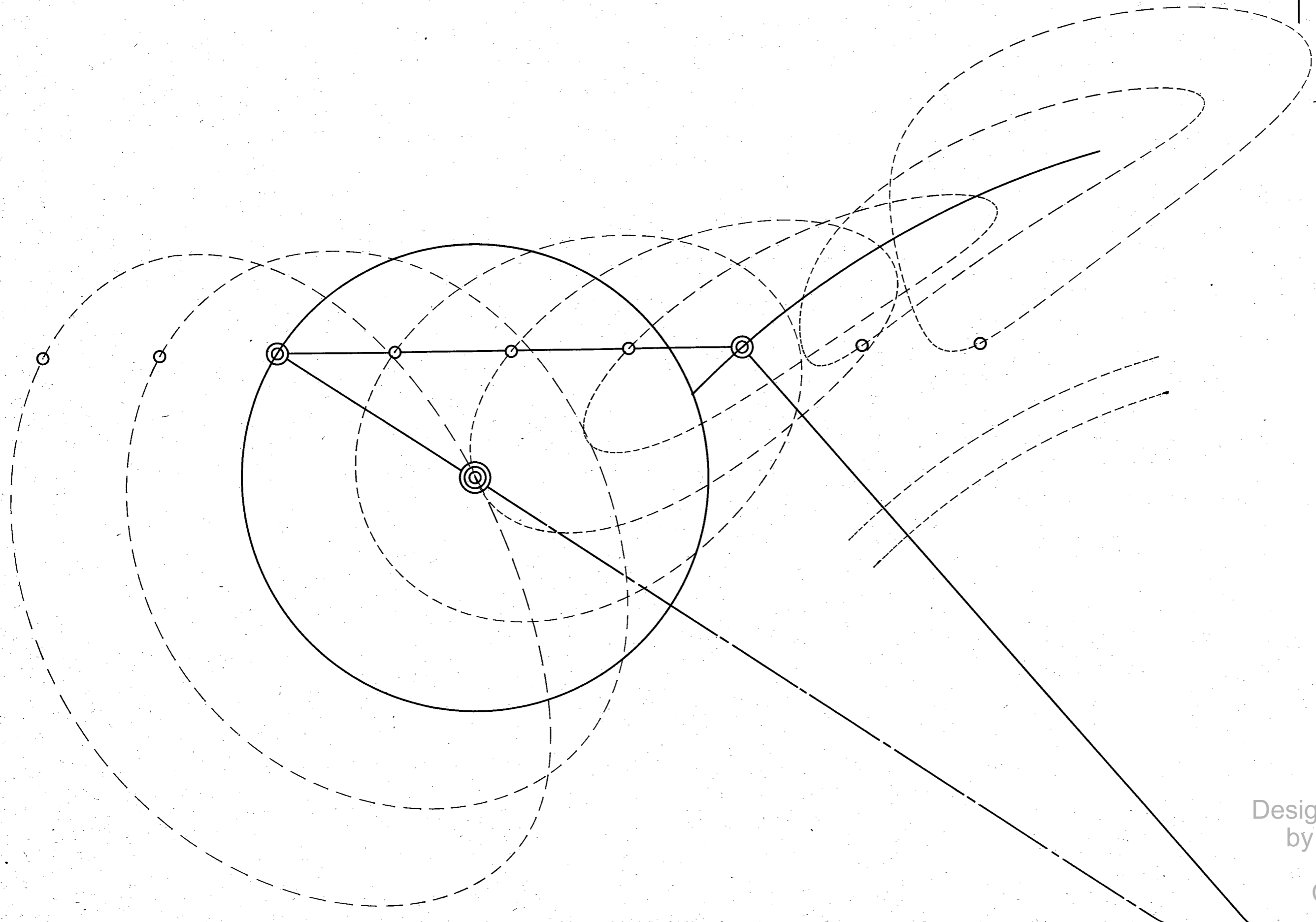
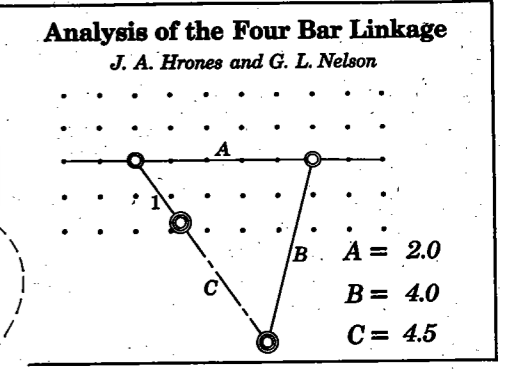

from  
Design of Machinery 4ed  
by Robert L. Norton  
McGraw-Hill  
Copyright 2008

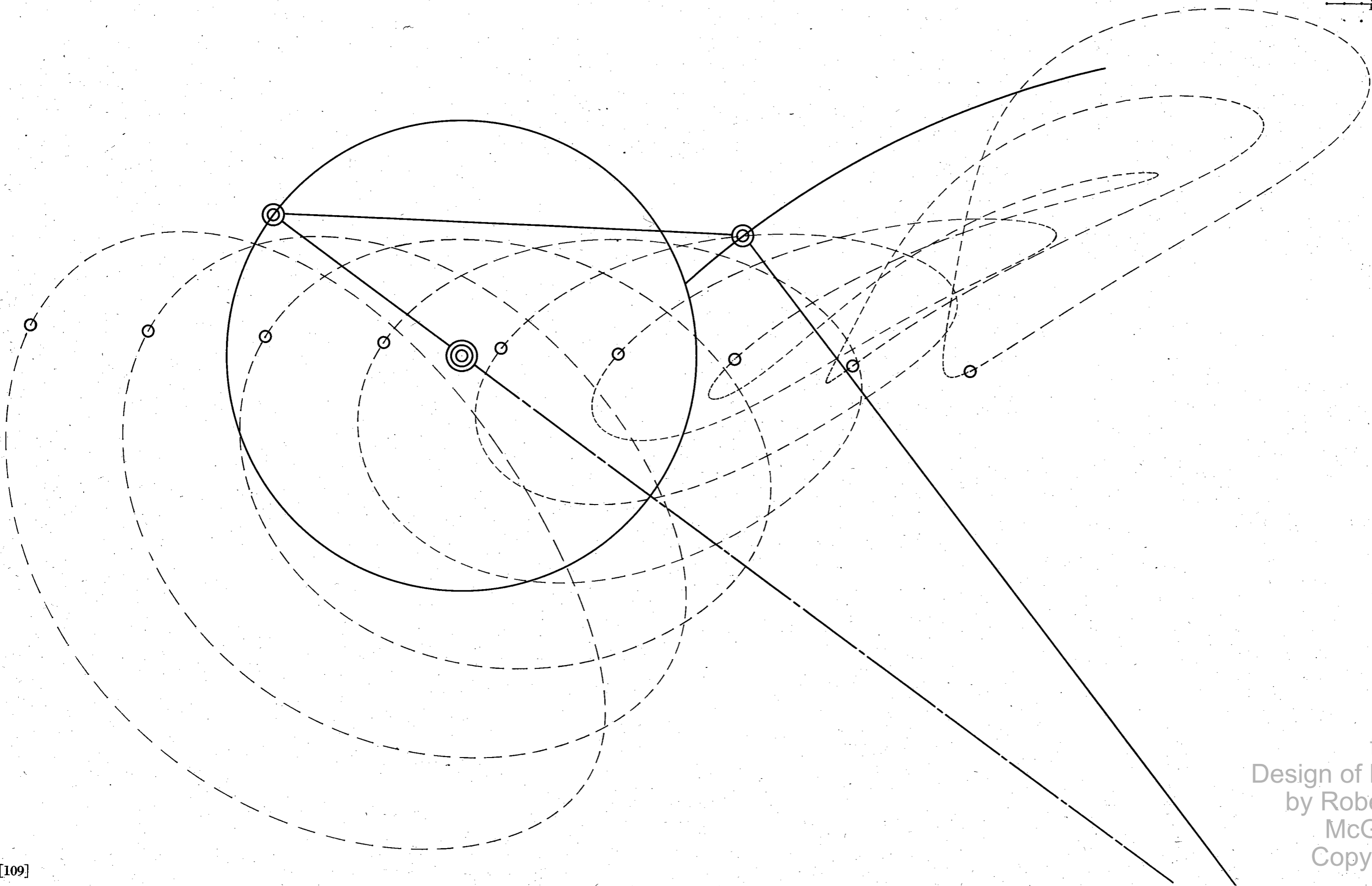
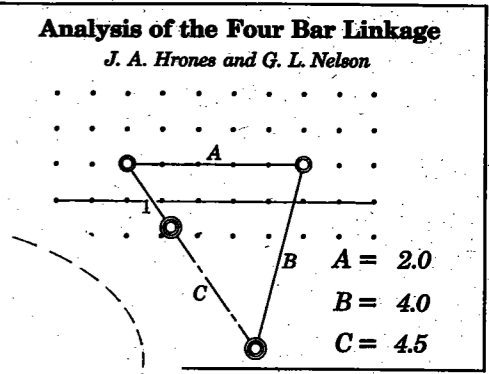

from  
 Design of Machinery 4ed  
 by Robert L. Norton  
 McGraw-Hill  
 Copyright 2008

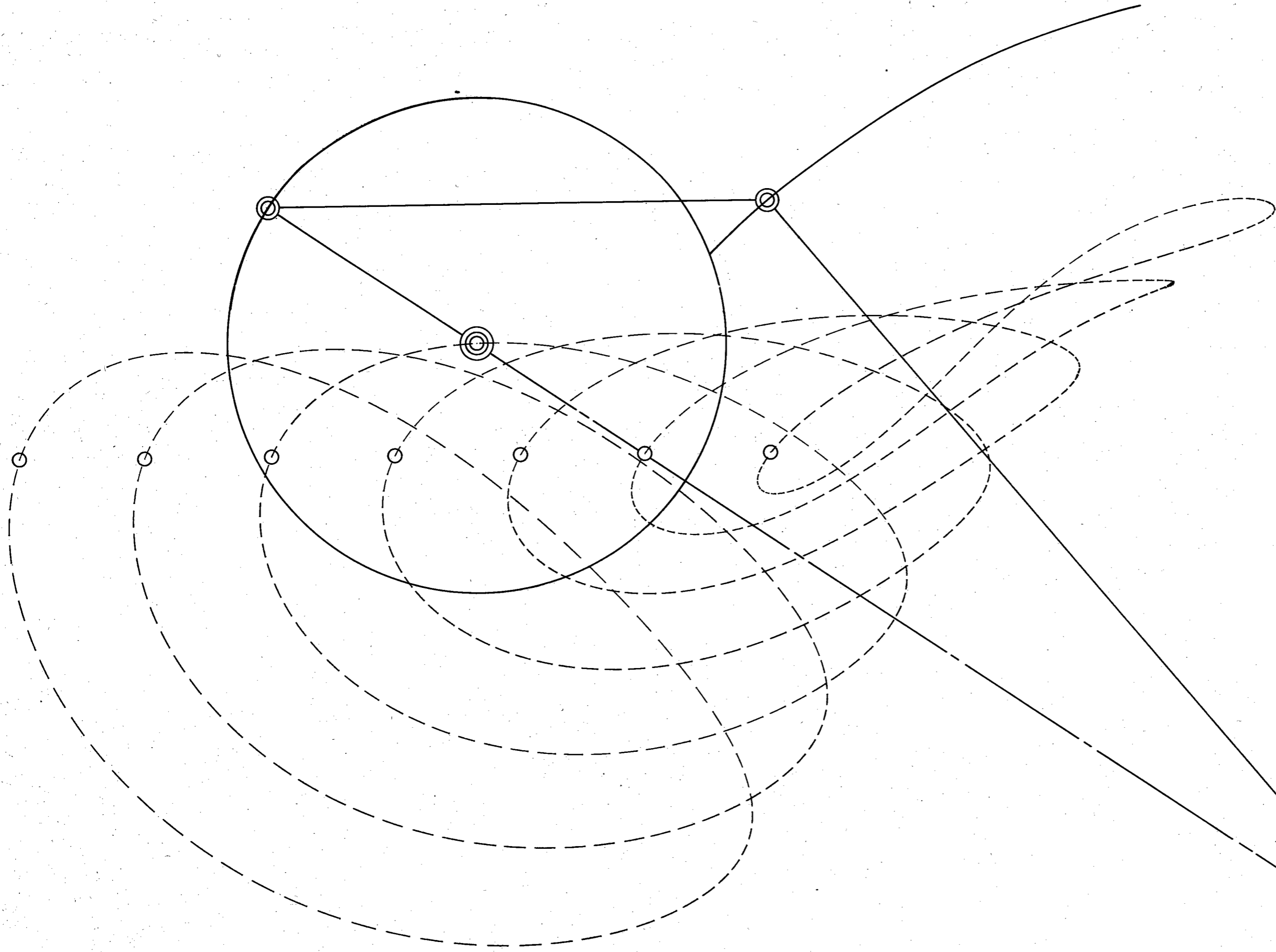
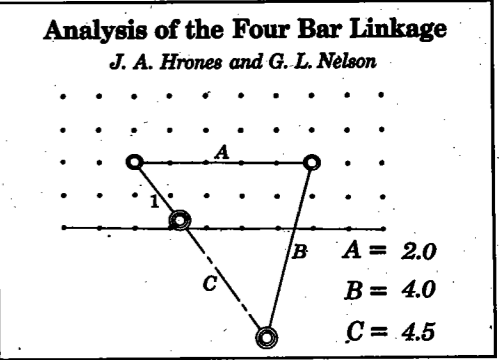

from  
Design of Machinery 4ed  
by Robert L. Norton  
© Graw-Hill  
Copyright 2008

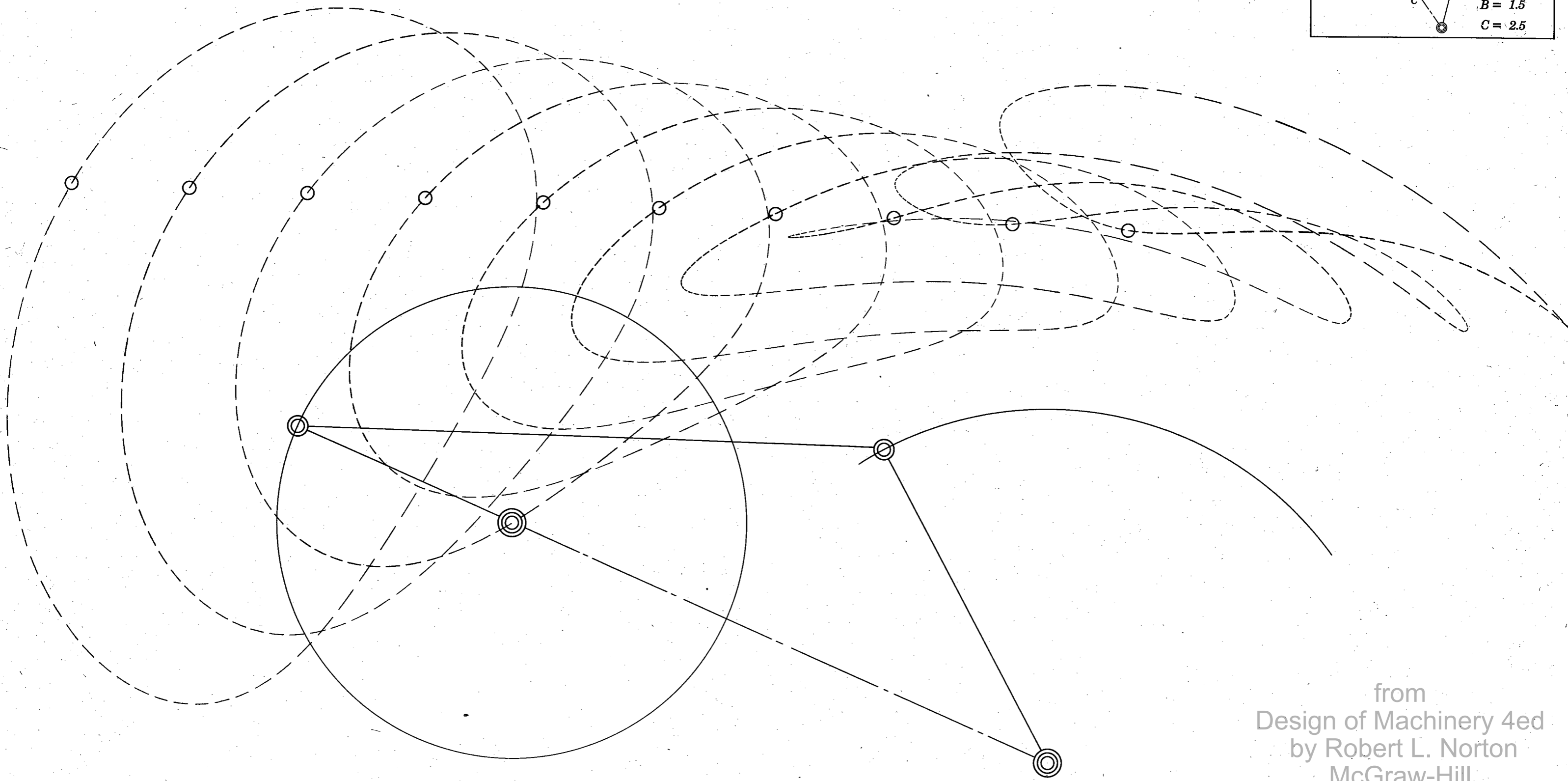
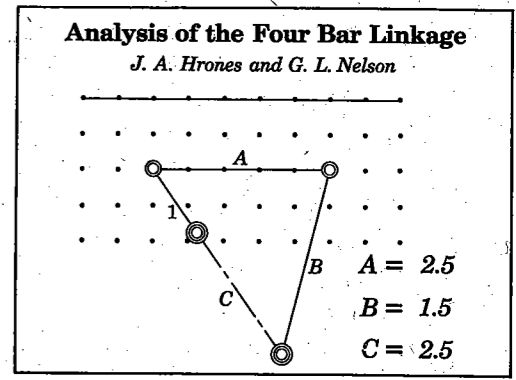

from  
 Design of Machinery 4ed  
 by Robert L. Norton  
 McGraw-Hill  
 Copyright 2008

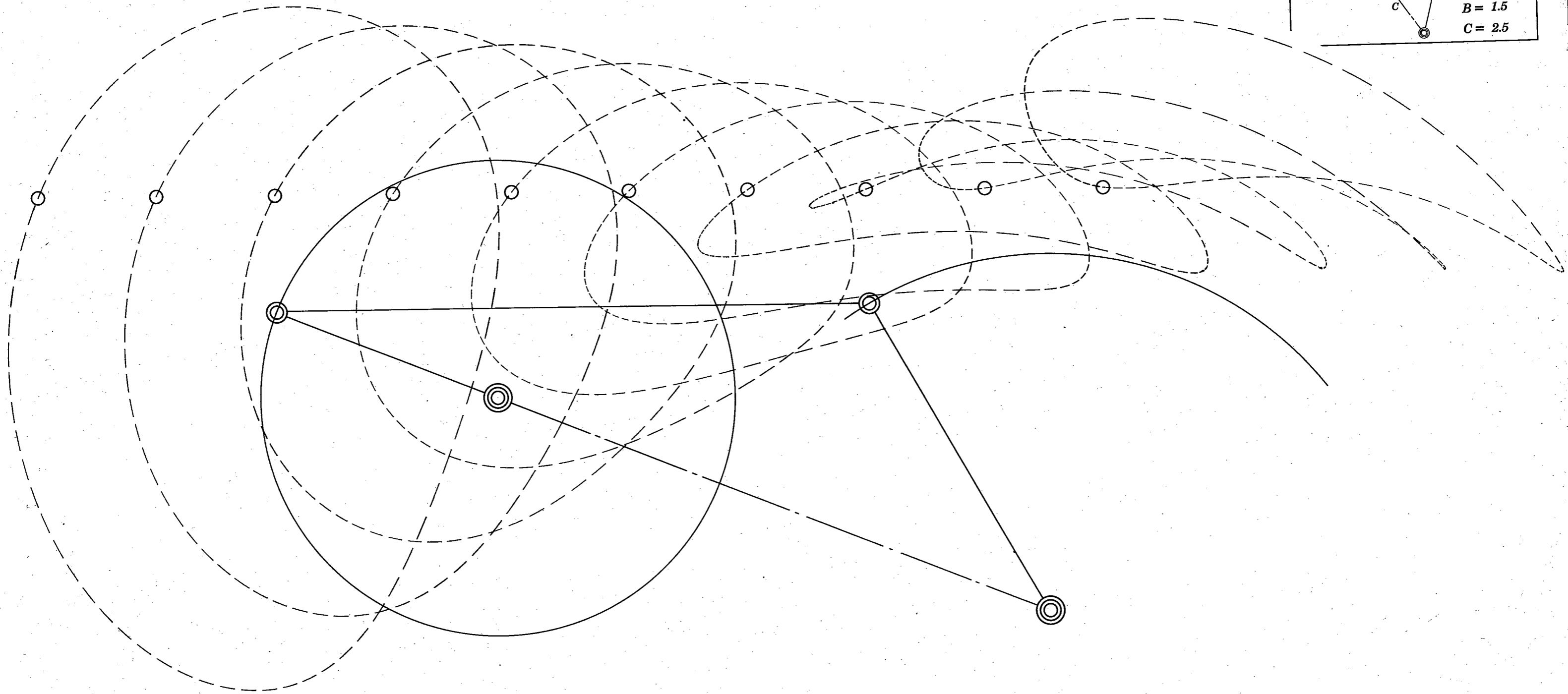
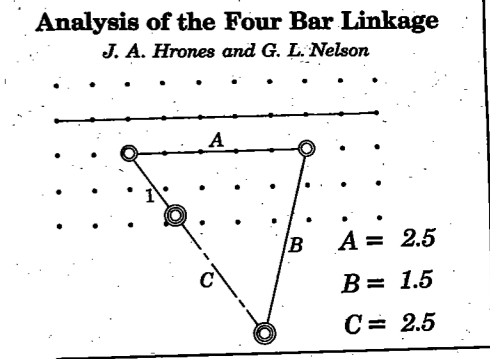

from  
Design of Machinery 4ed  
by Robert L. Norton  
McGraw-Hill  
Copyright 2008

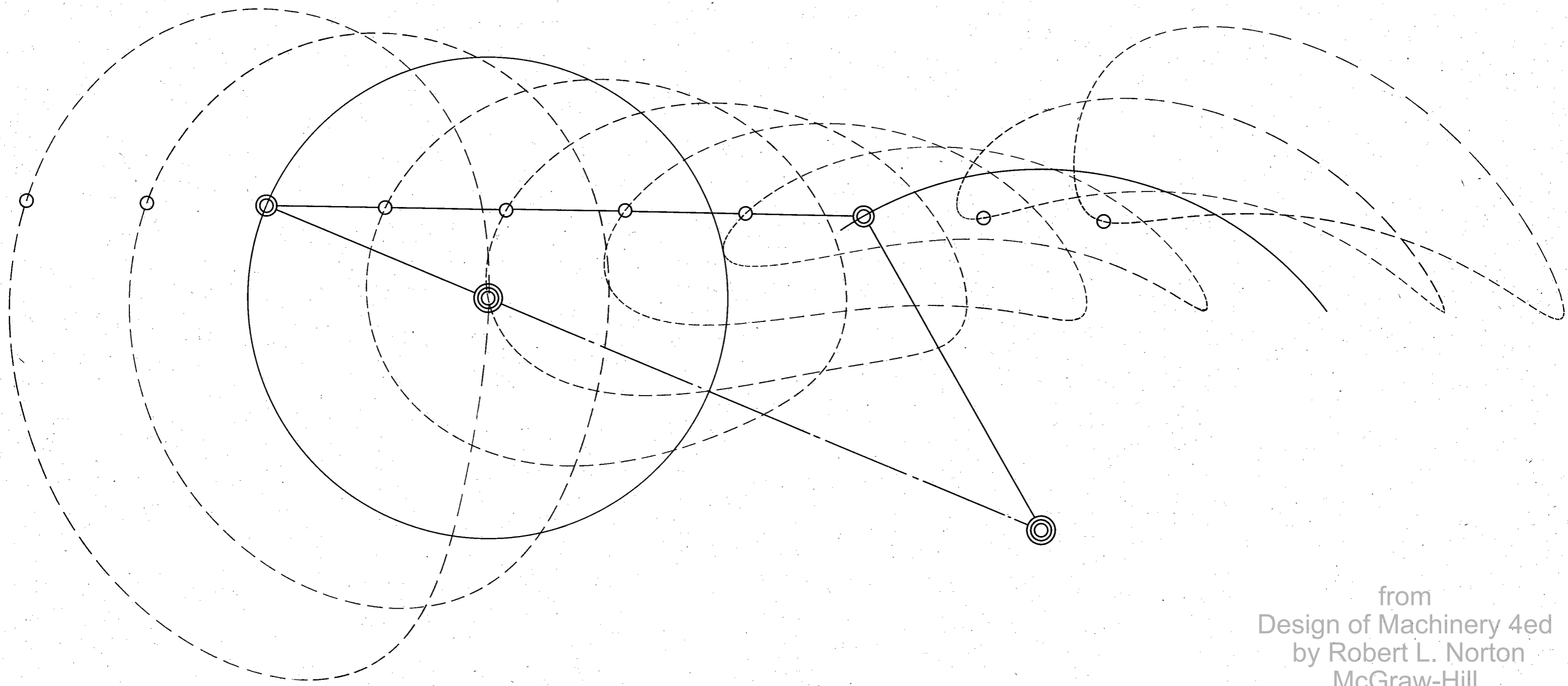
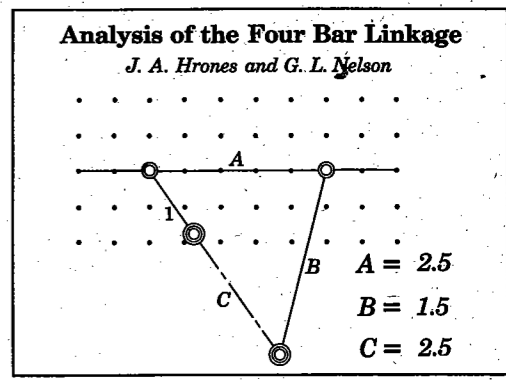

from  
 Design of Machinery 4ed  
 by Robert L. Norton  
 McGraw-Hill  
 Copyright 2008



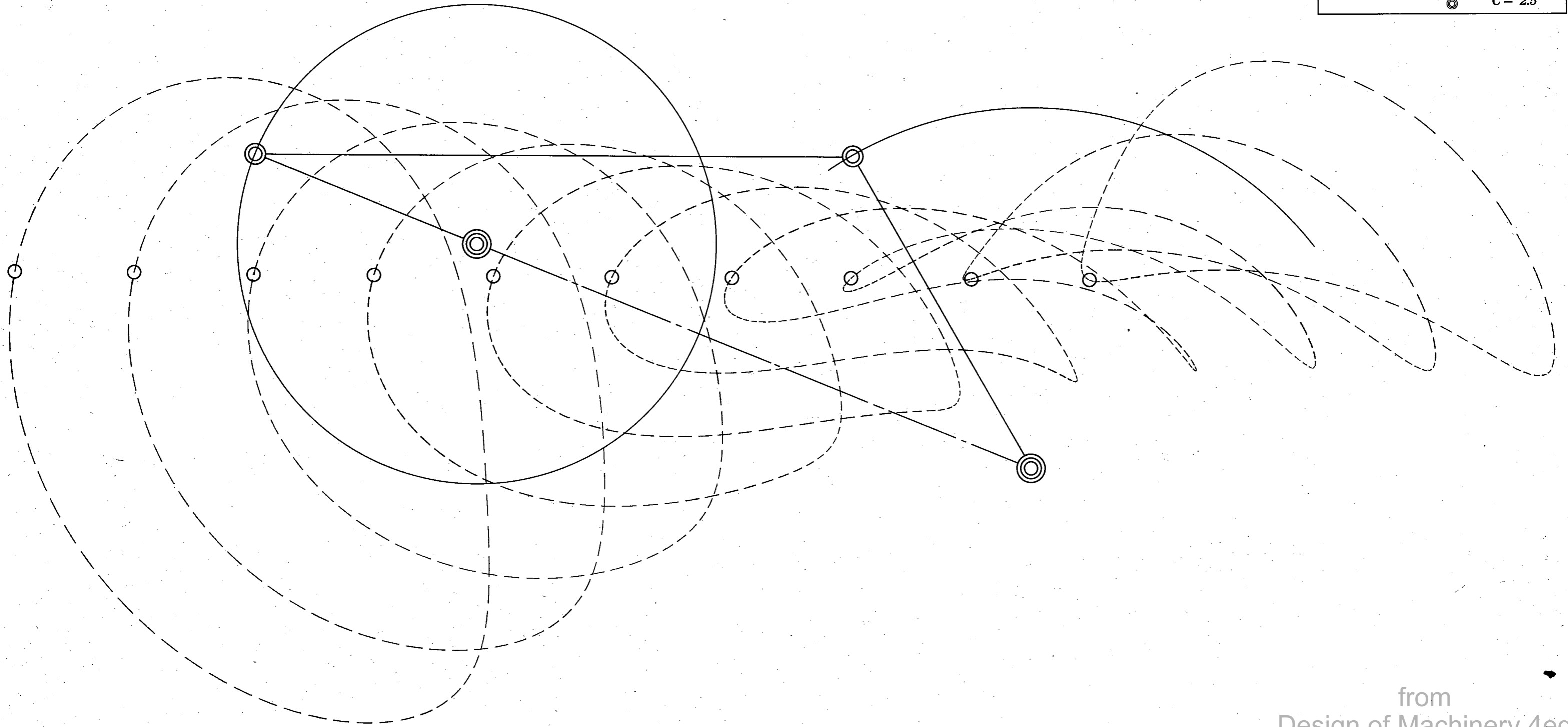
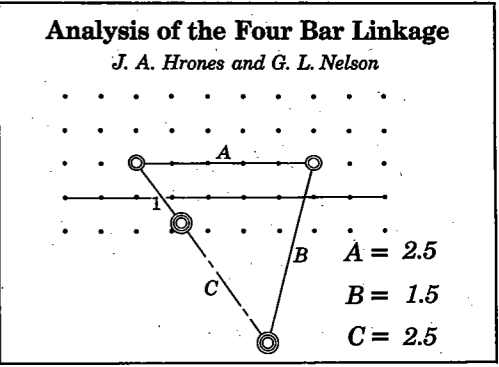

from  
Design of Machinery 4ed  
by Robert L. Norton  
McGraw-Hill  
Copyright 2008

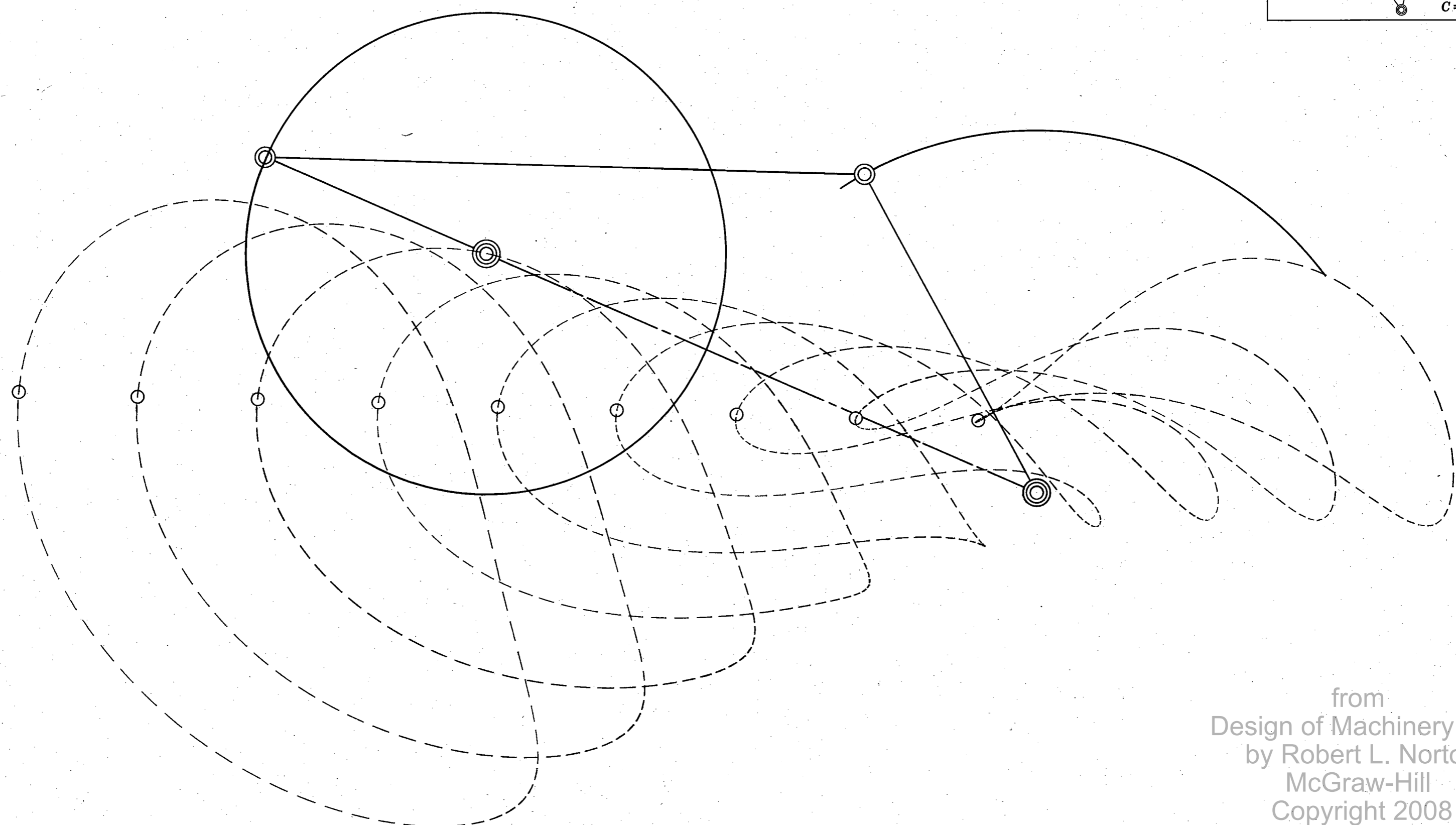
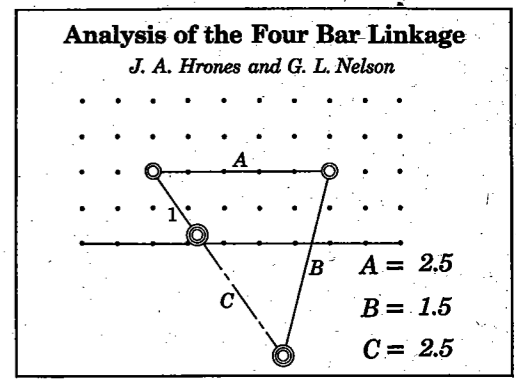

from  
 Design of Machinery 4ed  
 by Robert L. Norton  
 McGraw-Hill  
 Copyright 2008

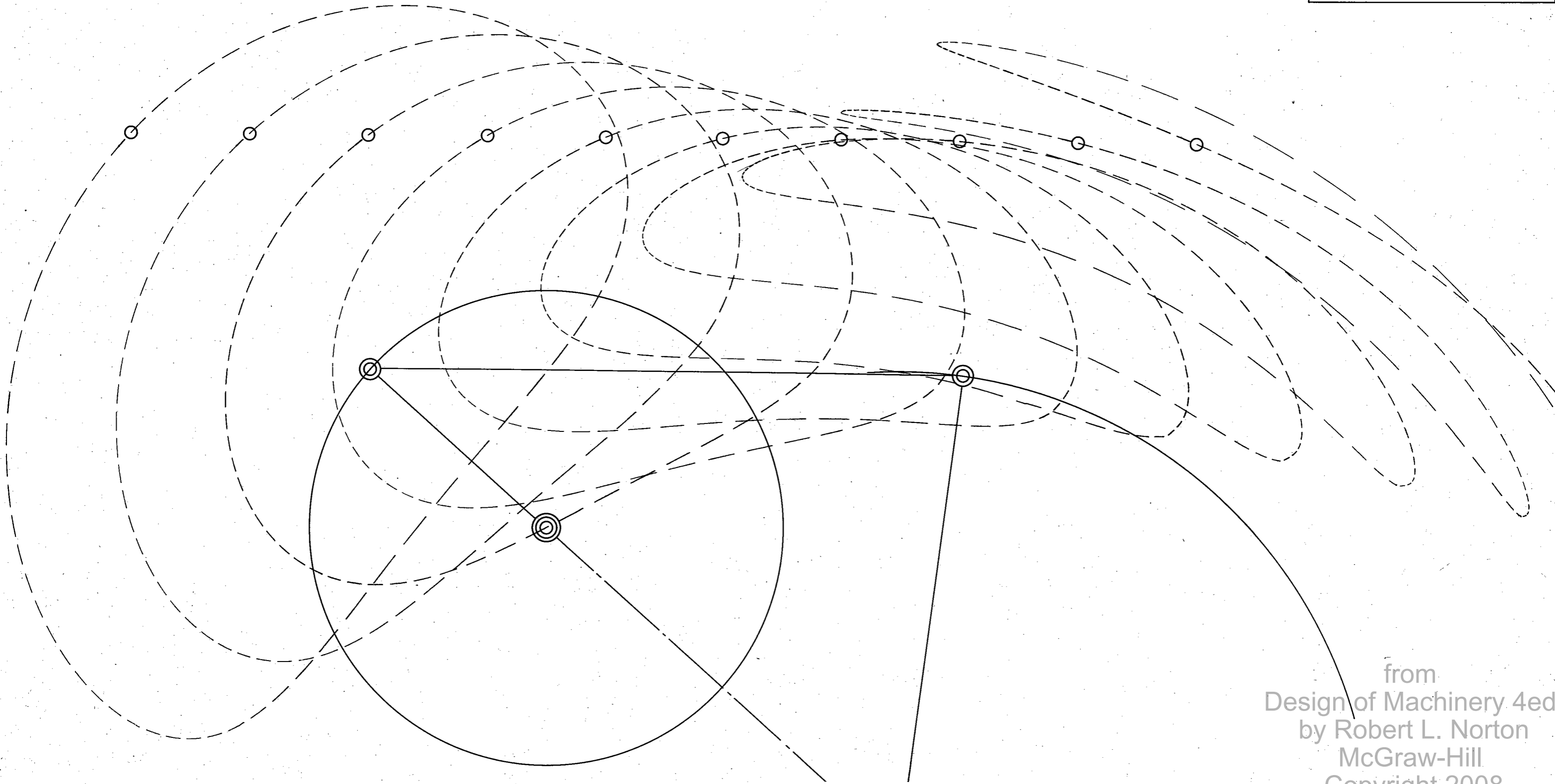
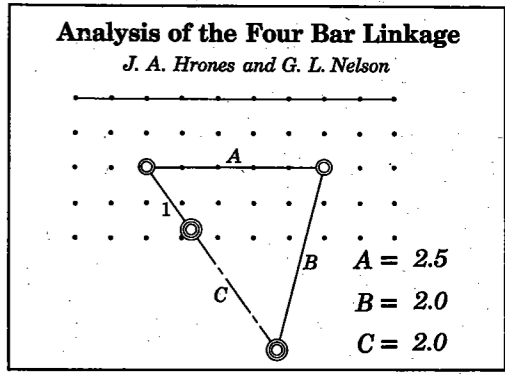

from  
Design of Machinery 4ed  
by Robert L. Norton  
McGraw-Hill  
Copyright 2008

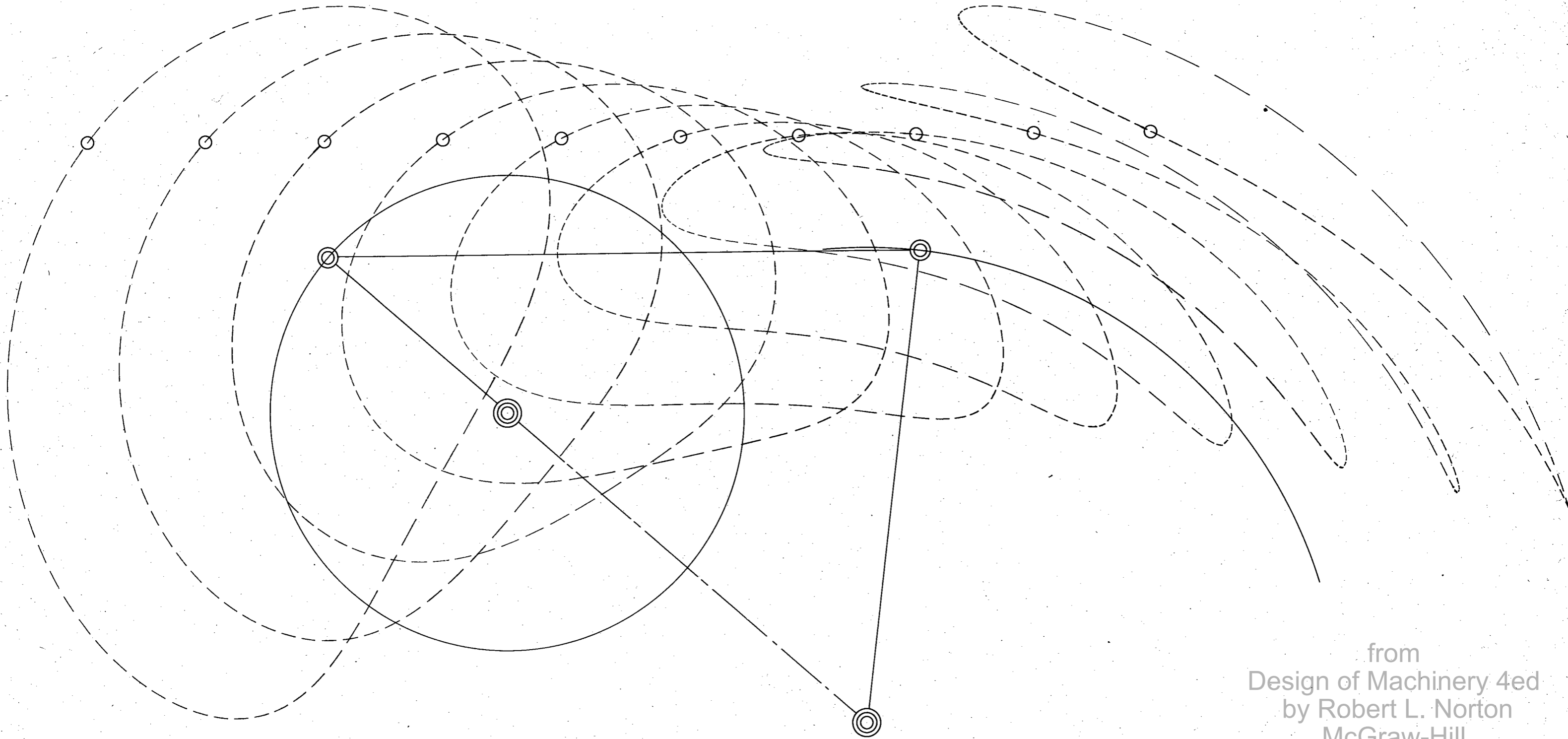
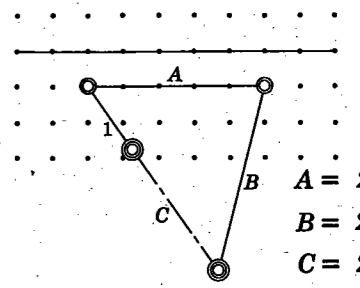

from  
Design of Machinery 4ed  
by Robert L. Norton  
McGraw-Hill  
Copyright 2008

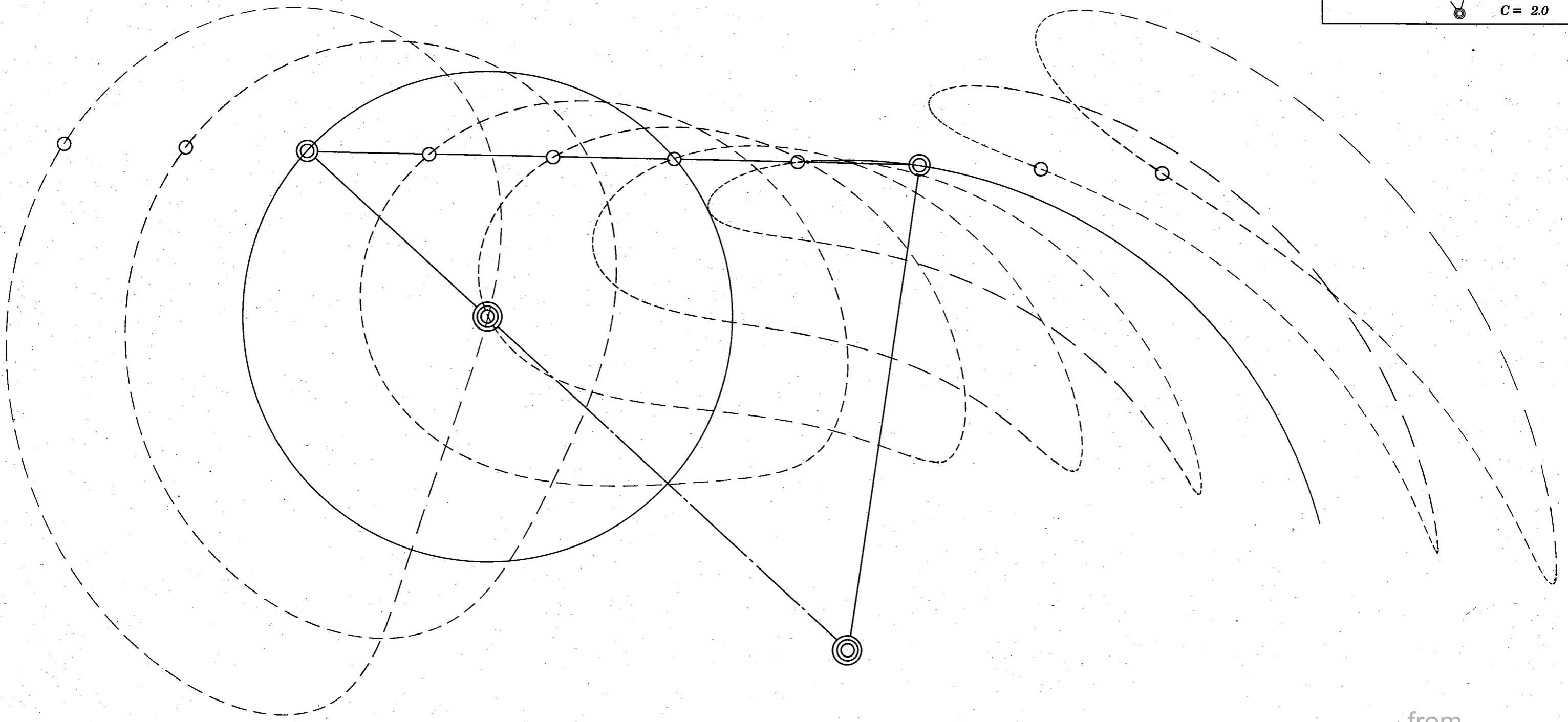
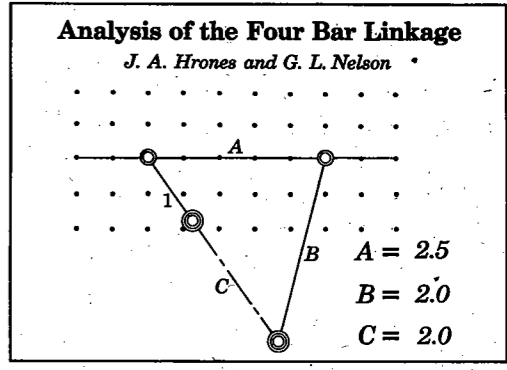

from  
Design of Machinery 4ed  
by Robert L. Norton  
McGraw-Hill  
Copyright 2008

**Analysis of the Four Bar Linkage**

*J. A. Hrones and G. L. Nelson*

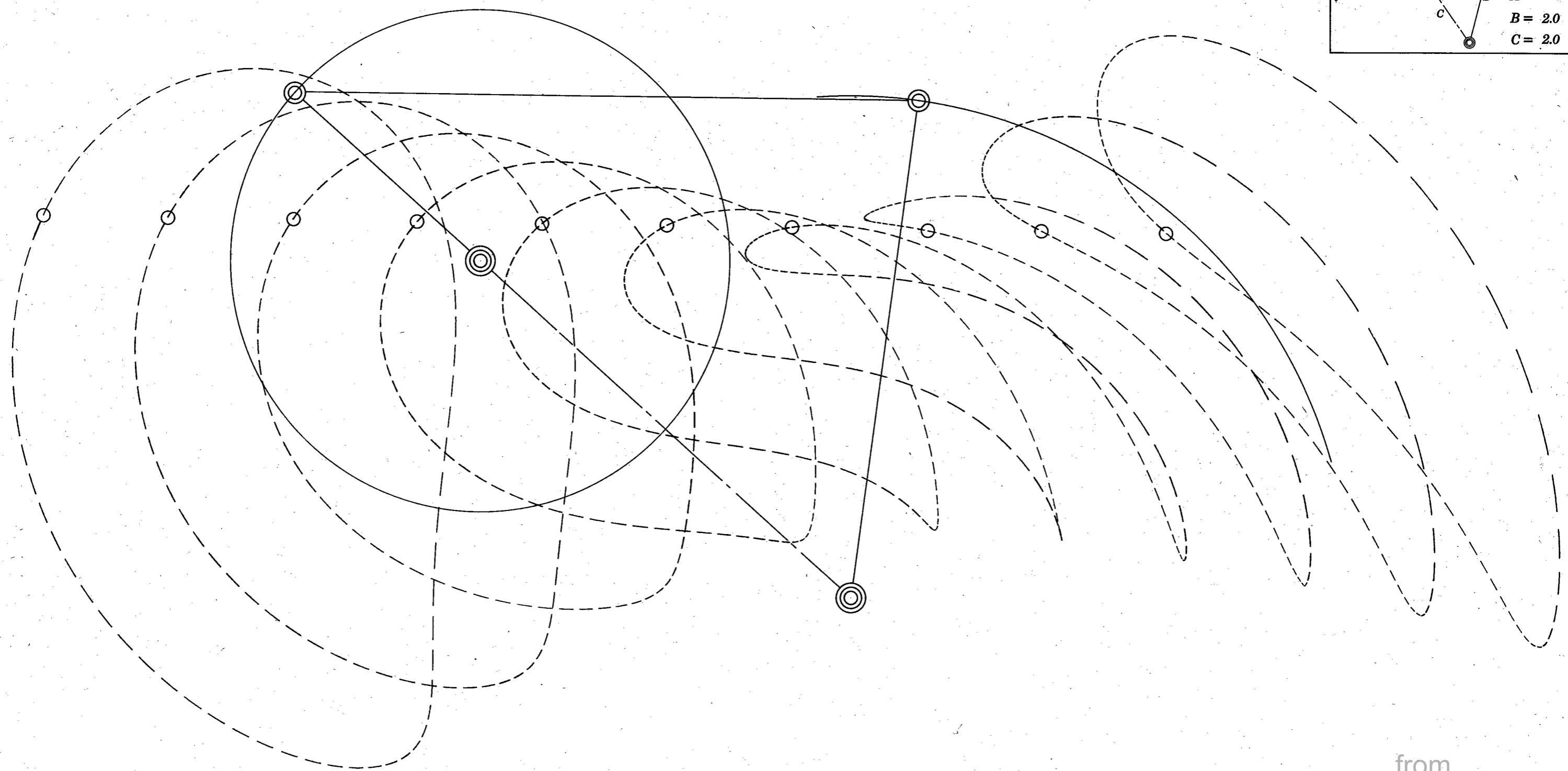
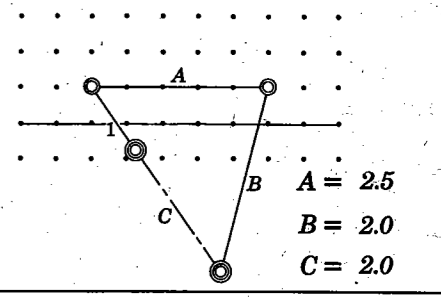

from  
Design of Machinery 4ed  
by Robert L. Norton  
McGraw-Hill  
Copyright 2008

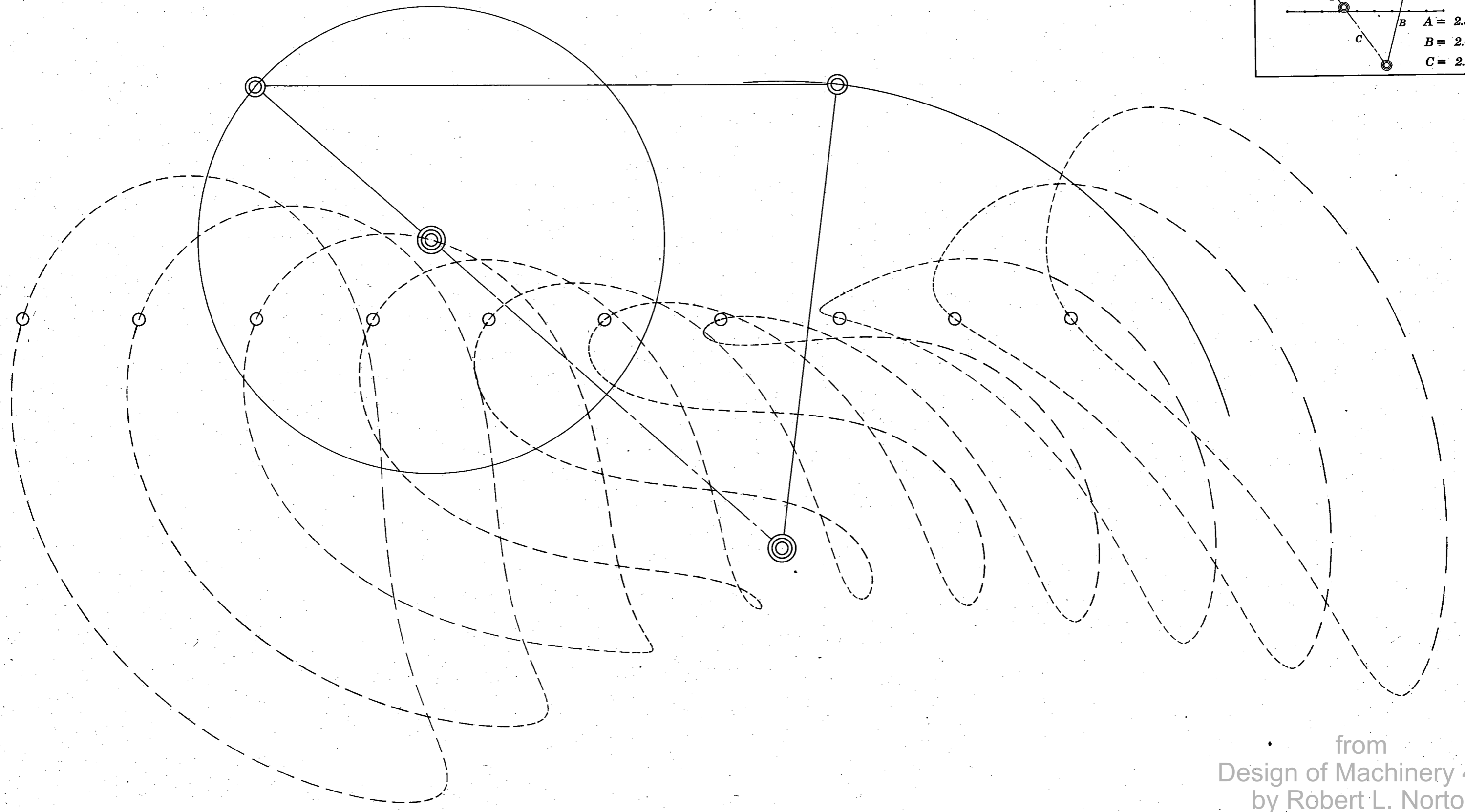
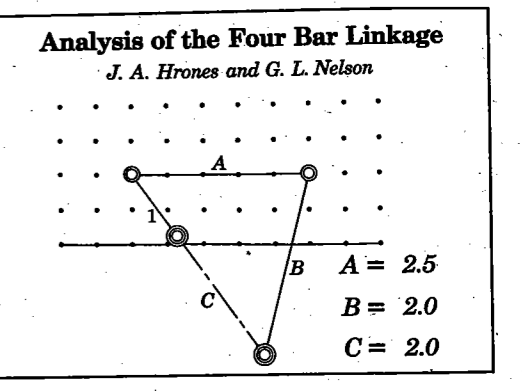

from  
Design of Machinery 4ed  
by Robert L. Norton  
McGraw-Hill  
Copyright 2008

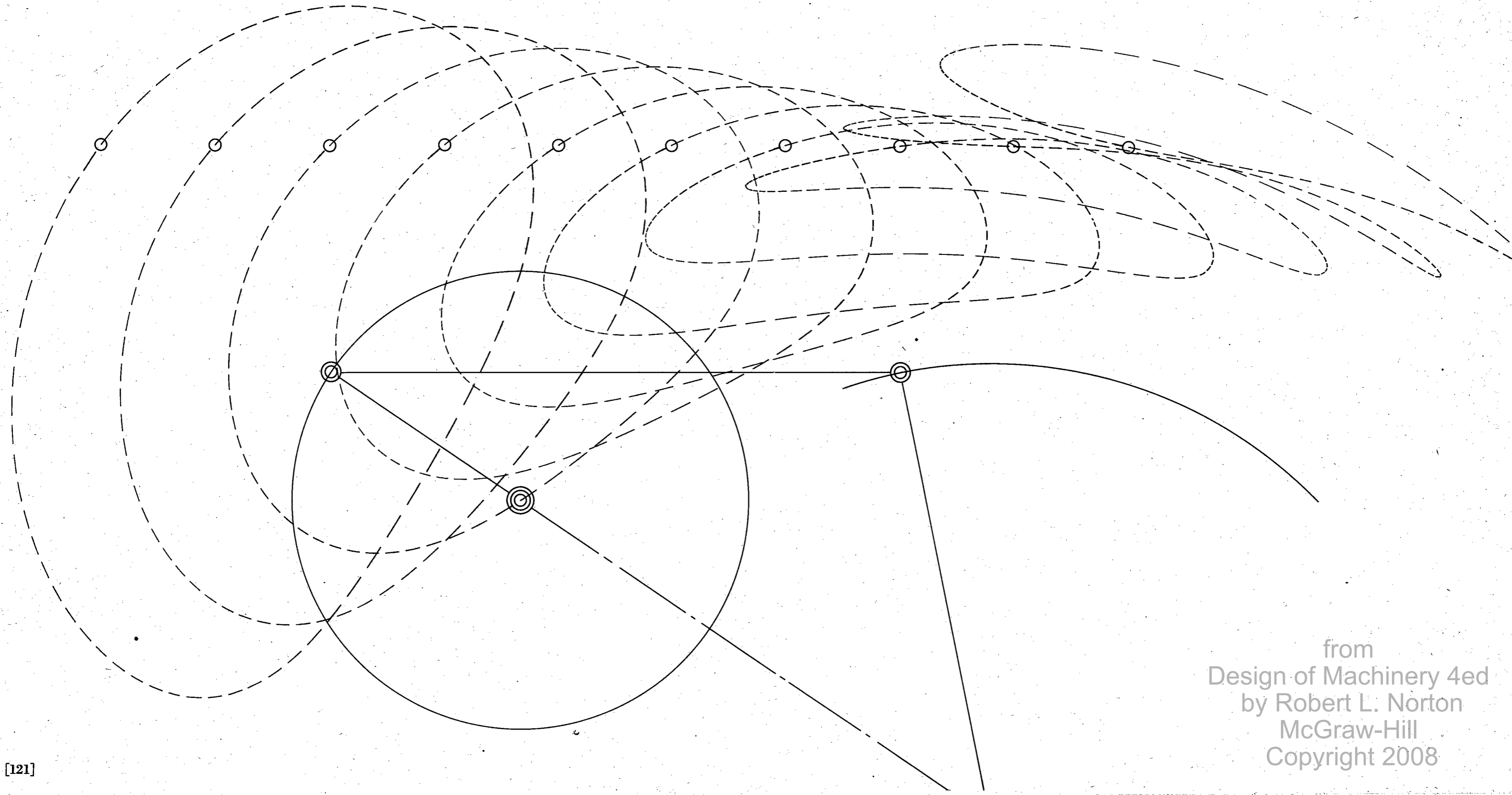
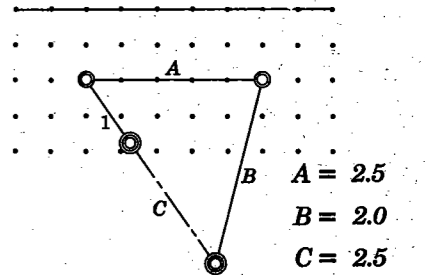

from  
Design of Machinery 4ed  
by Robert L. Norton  
McGraw-Hill  
Copyright 2008



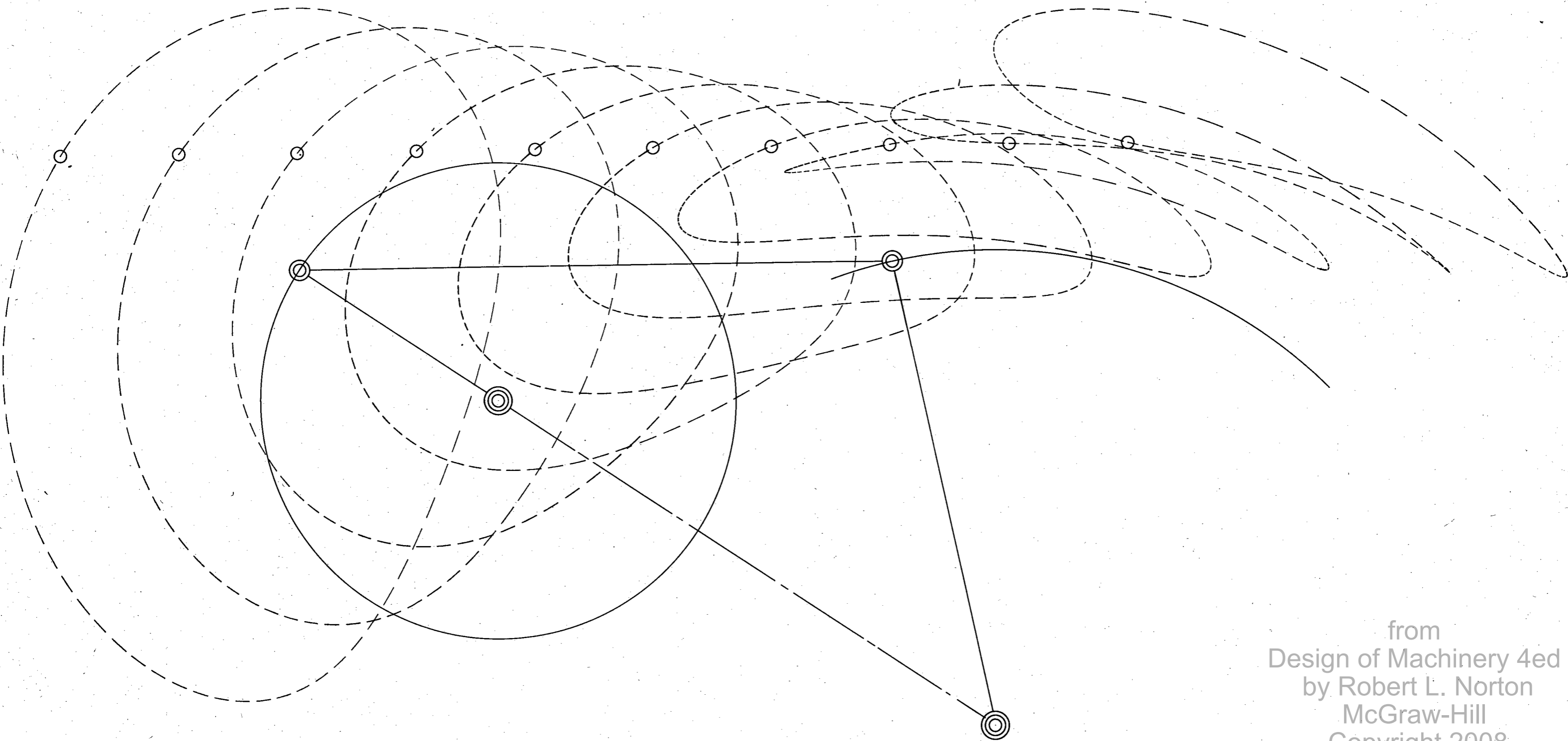
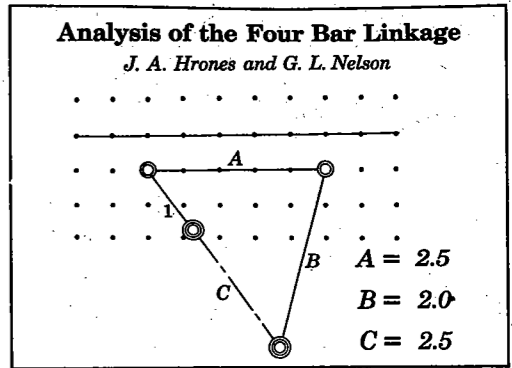

from  
Design of Machinery 4ed  
by Robert L. Norton  
McGraw-Hill  
Copyright 2008

**Analysis of the Four Bar Linkage**

*J. A. Hrones and G. L. Nelson*

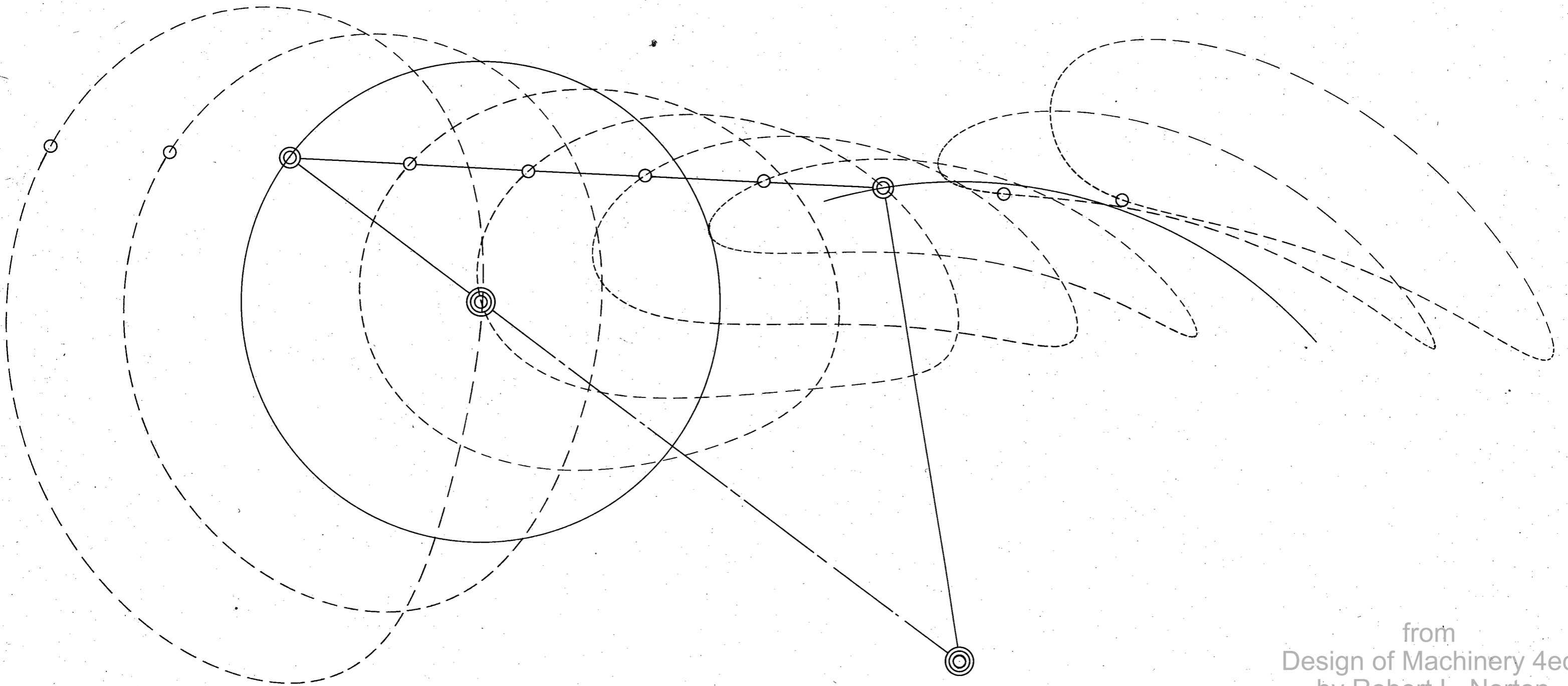
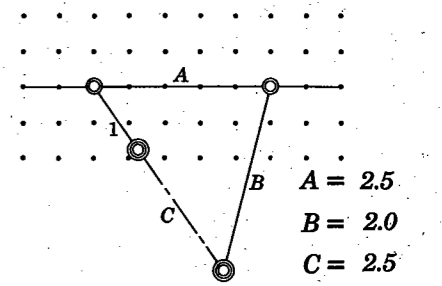

from  
Design of Machinery 4ed  
by Robert L. Norton  
McGraw-Hill  
Copyright 2008

**Analysis of the Four Bar Linkage**

*J. A. Hrones and G. L. Nelson*

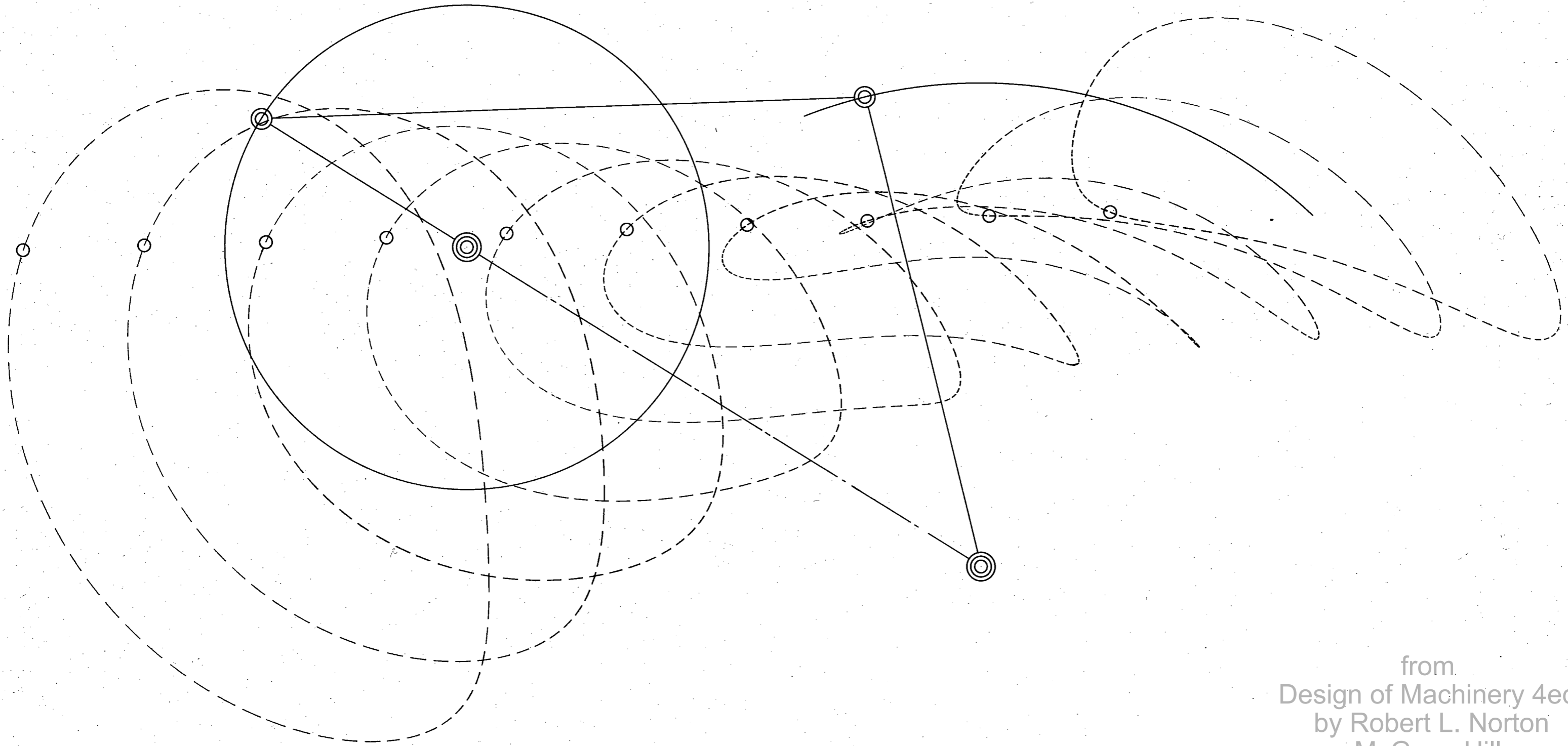
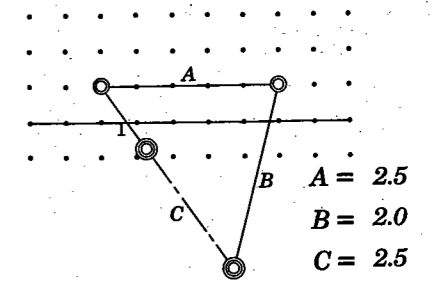

from  
Design of Machinery 4ed  
by Robert L. Norton  
McGraw-Hill  
Copyright 2008

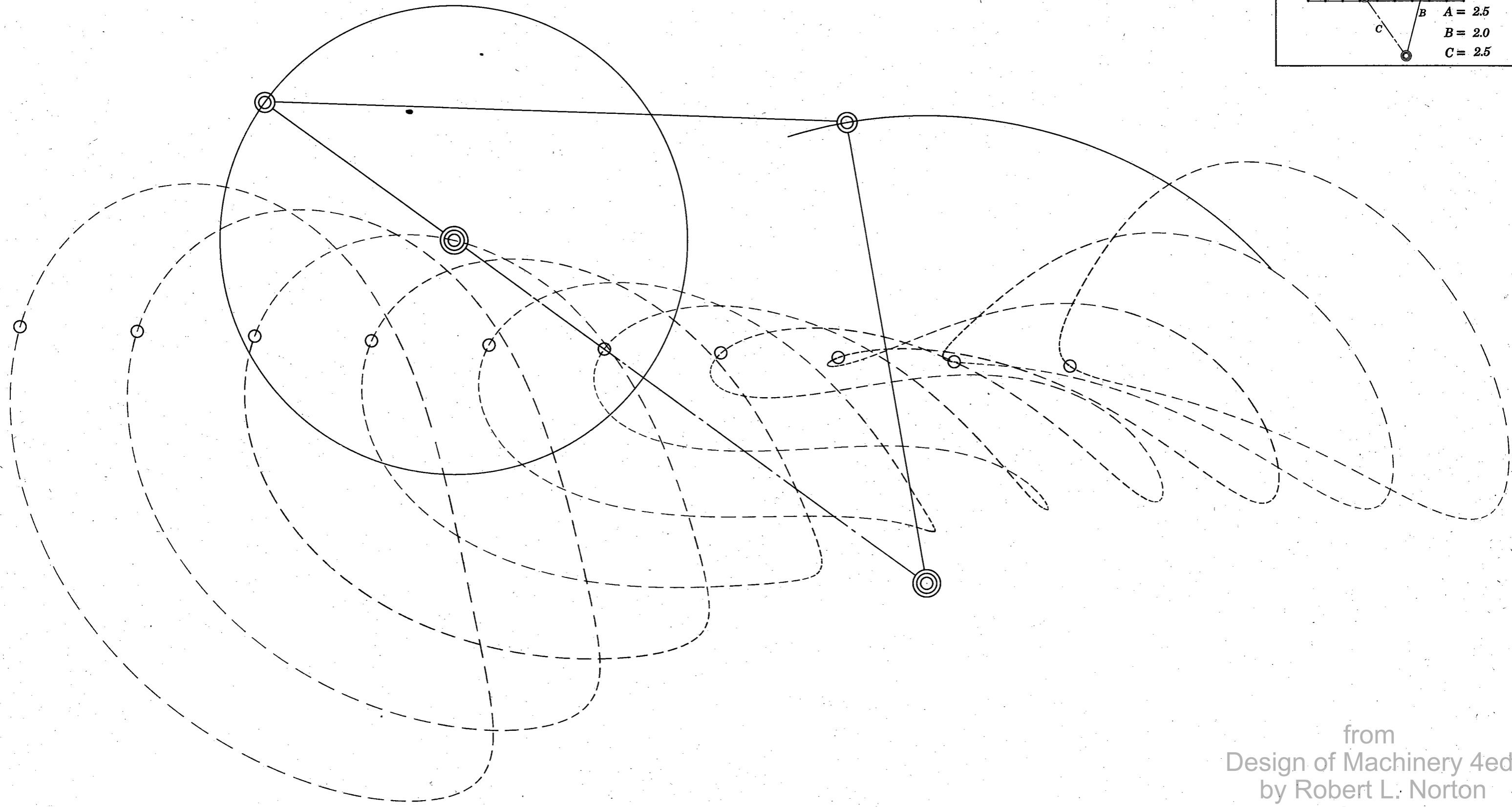
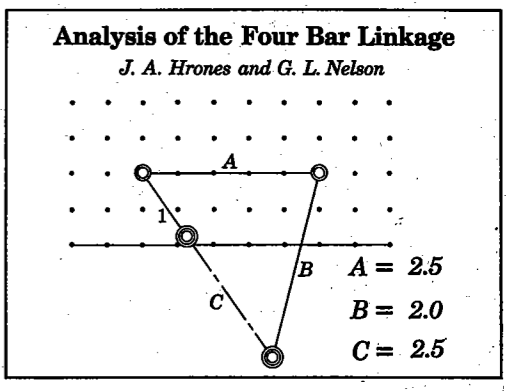

from  
 Design of Machinery 4ed  
 by Robert L. Norton  
 McGraw-Hill  
 Copyright 2008

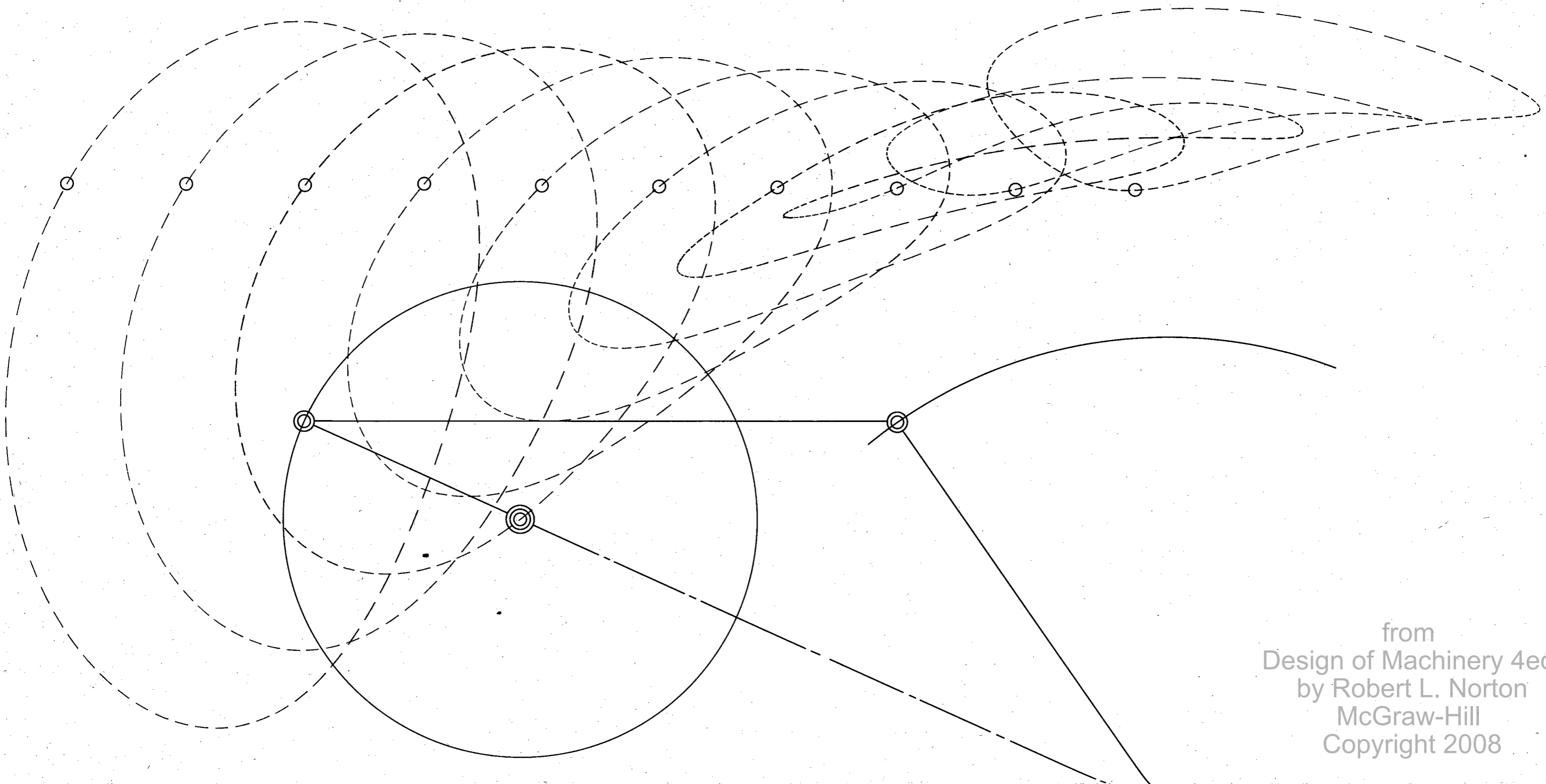
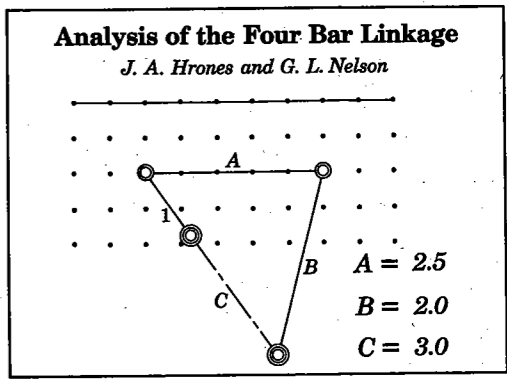

from  
Design of Machinery 4ed  
by Robert L. Norton  
McGraw-Hill  
Copyright 2008

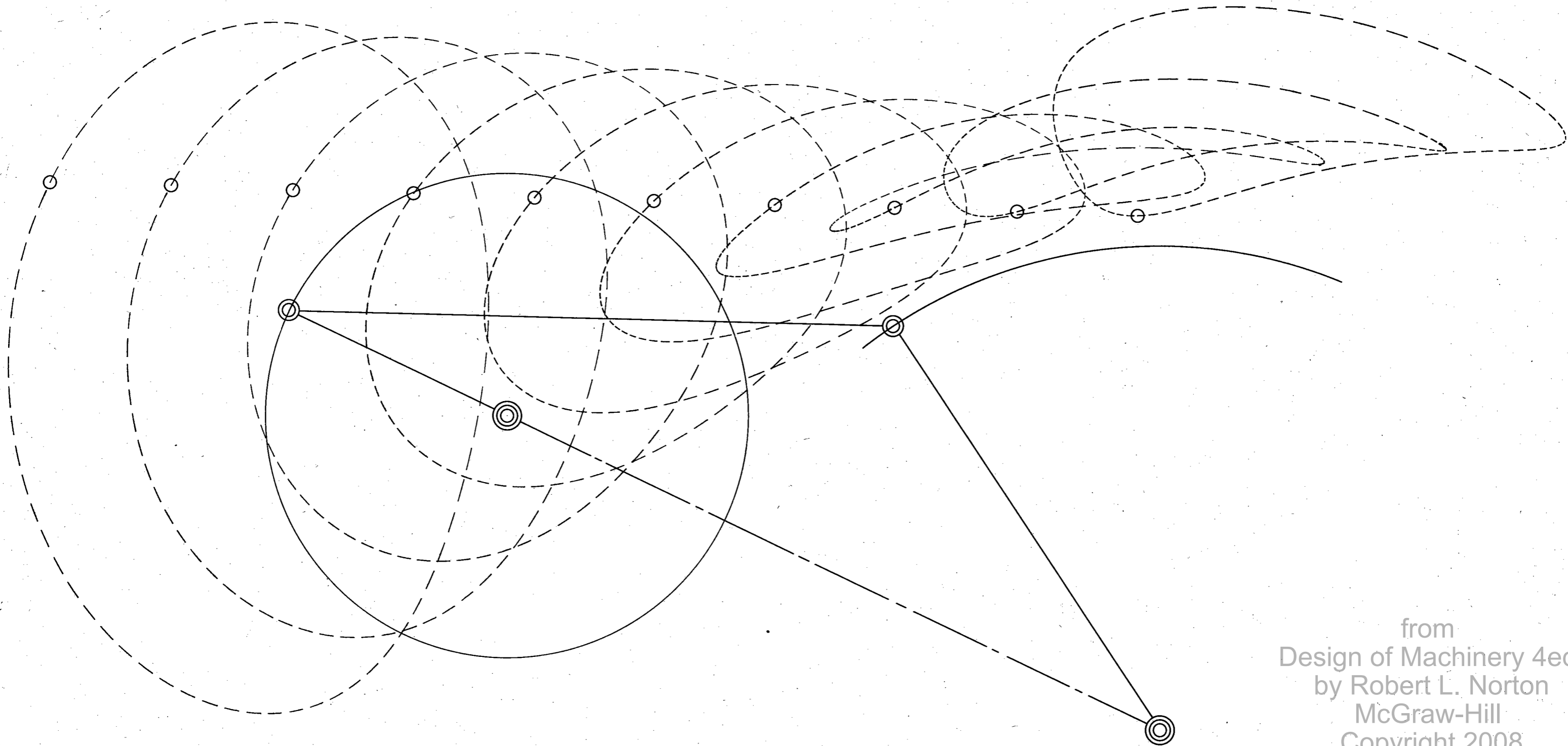
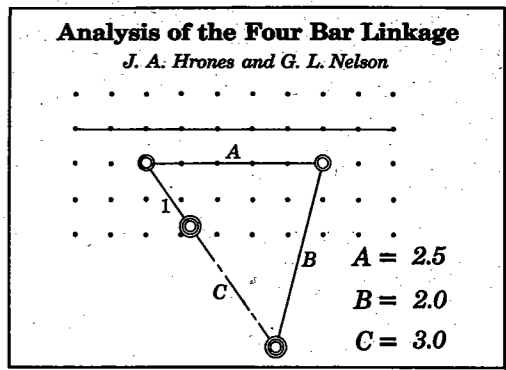

from  
 Design of Machinery 4ed  
 by Robert L. Norton  
 McGraw-Hill  
 Copyright 2008

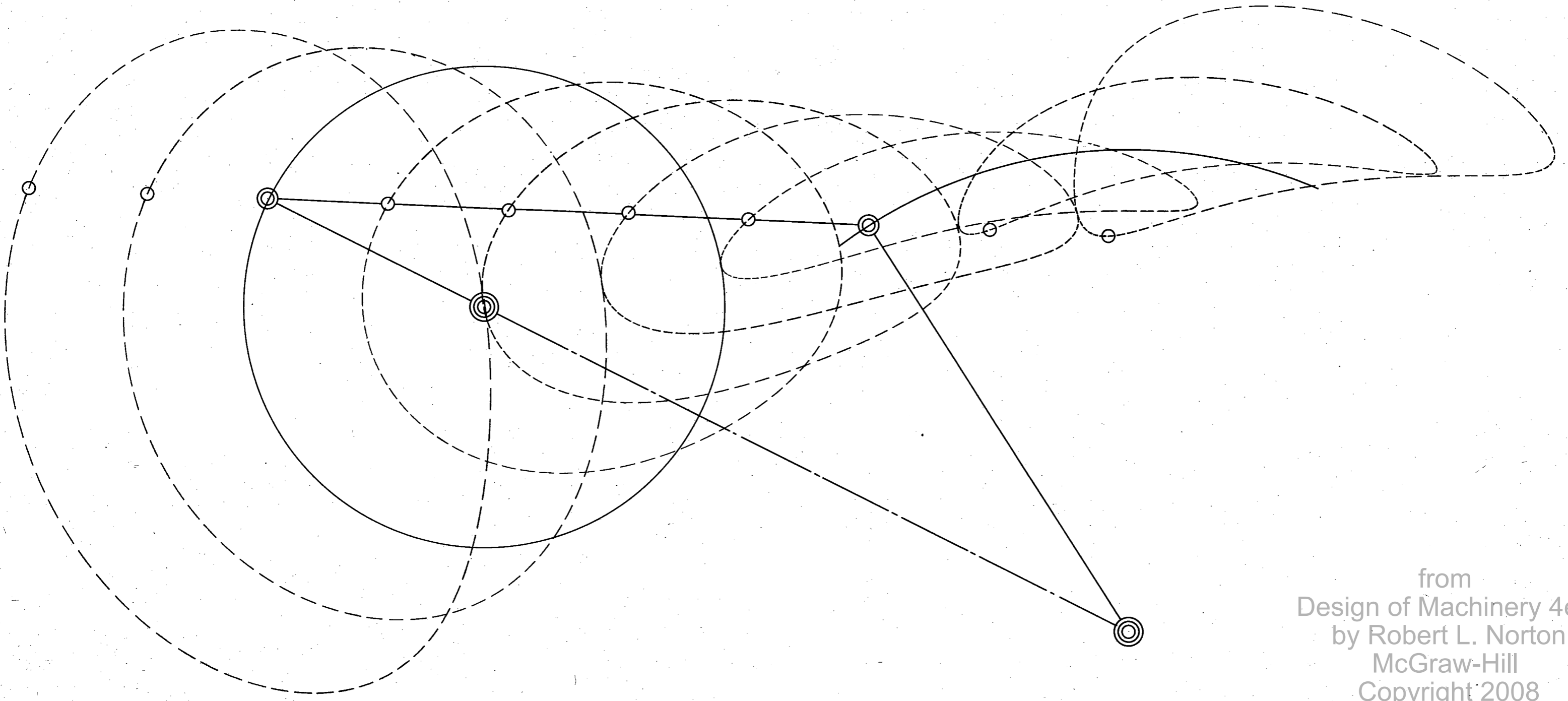
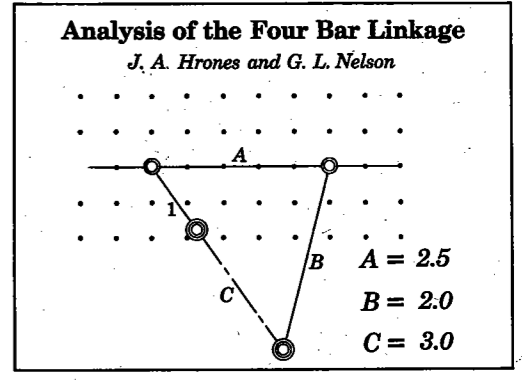

from  
Design of Machinery 4ed  
by Robert L. Norton  
McGraw-Hill  
Copyright 2008

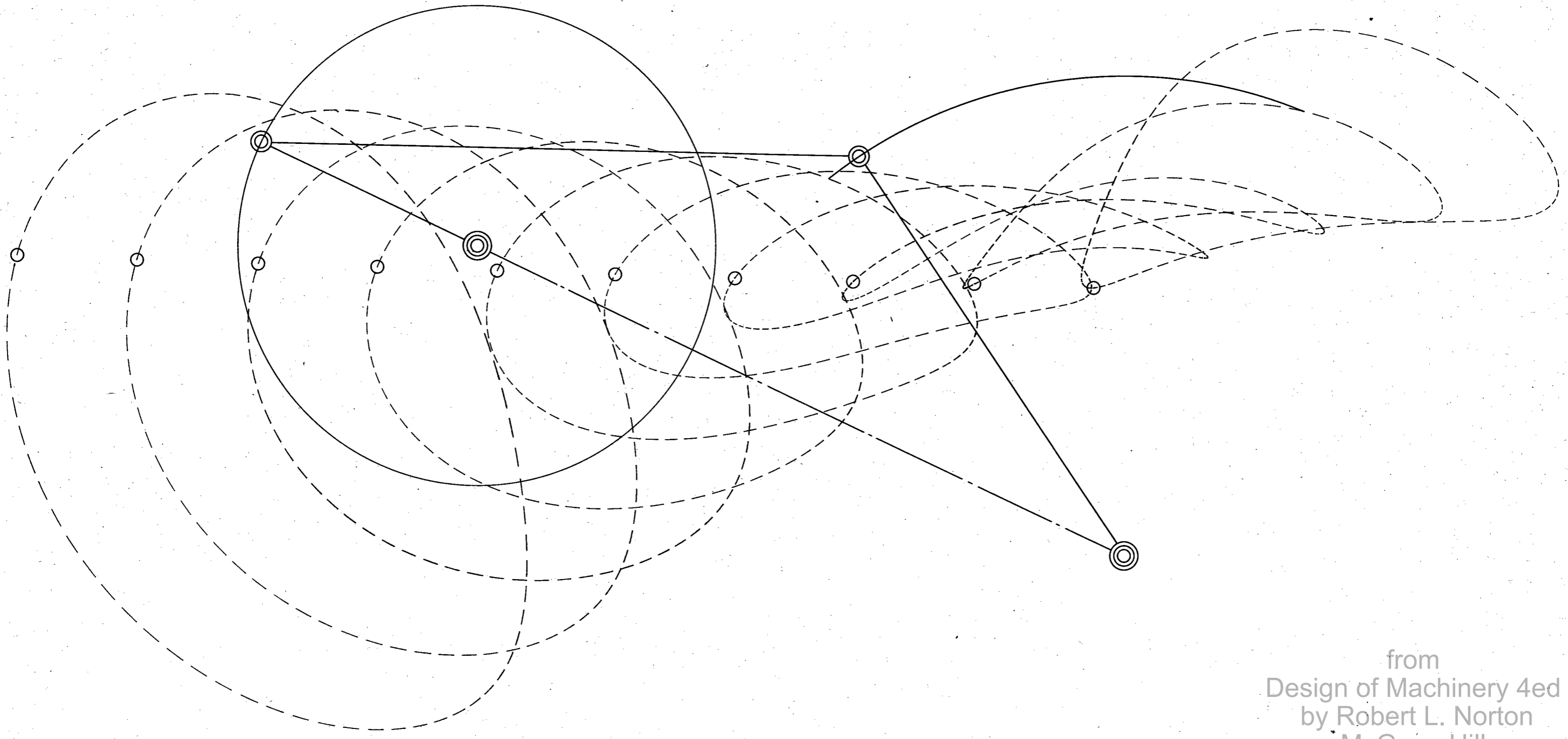
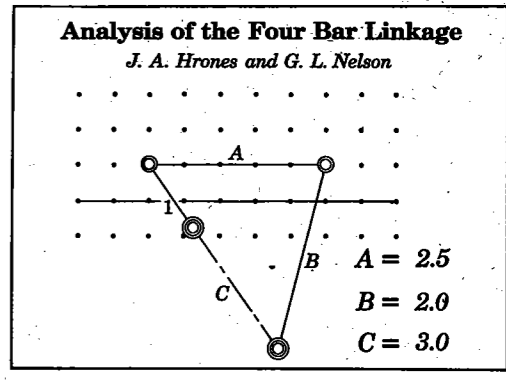

from  
 Design of Machinery 4ed  
 by Robert L. Norton  
 McGraw-Hill  
 Copyright 2008



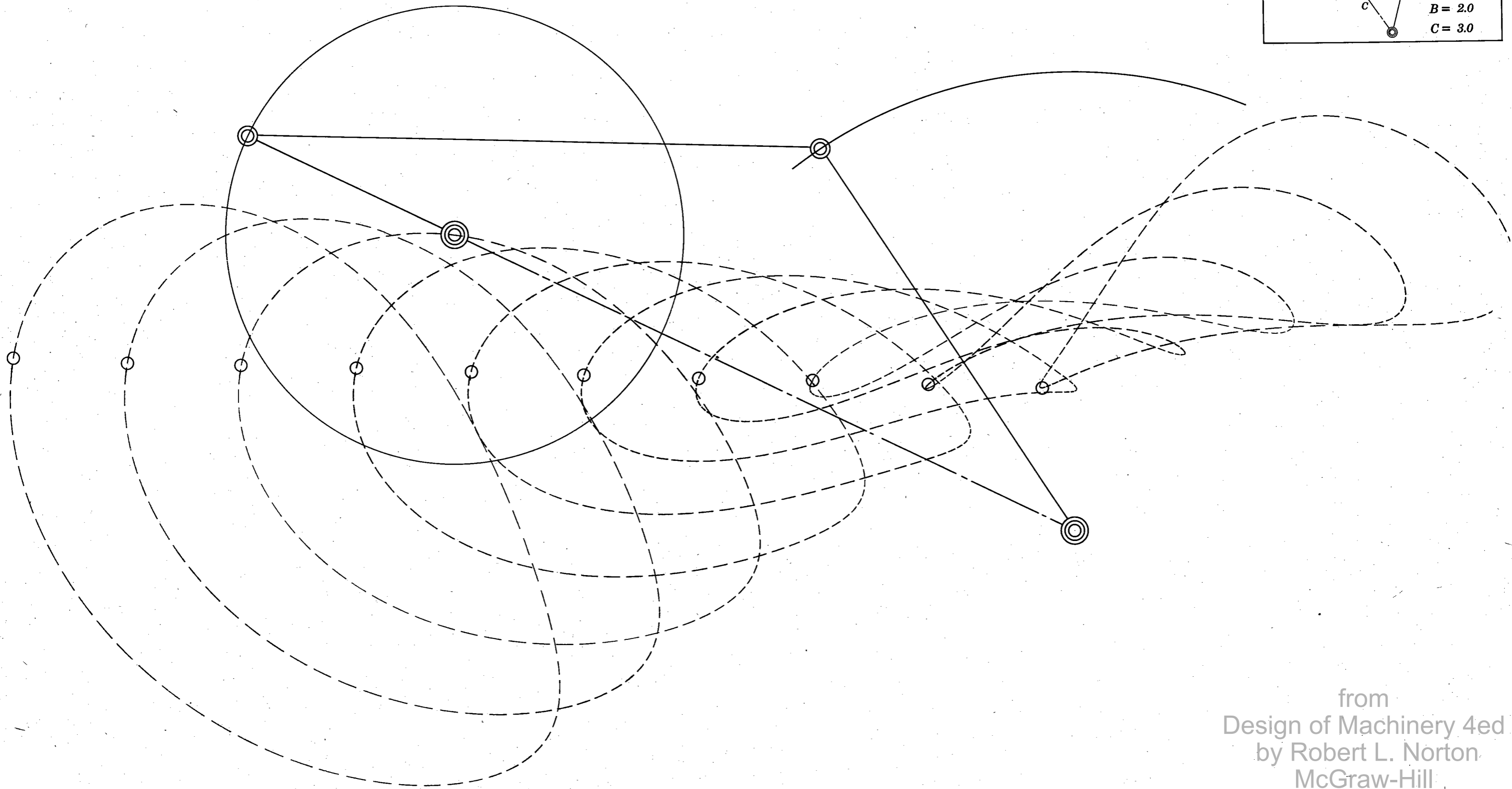
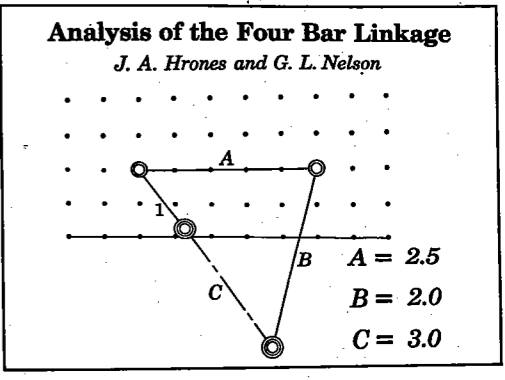

from  
Design of Machinery 4ed  
by Robert L. Norton  
McGraw-Hill  
Copyright 2008

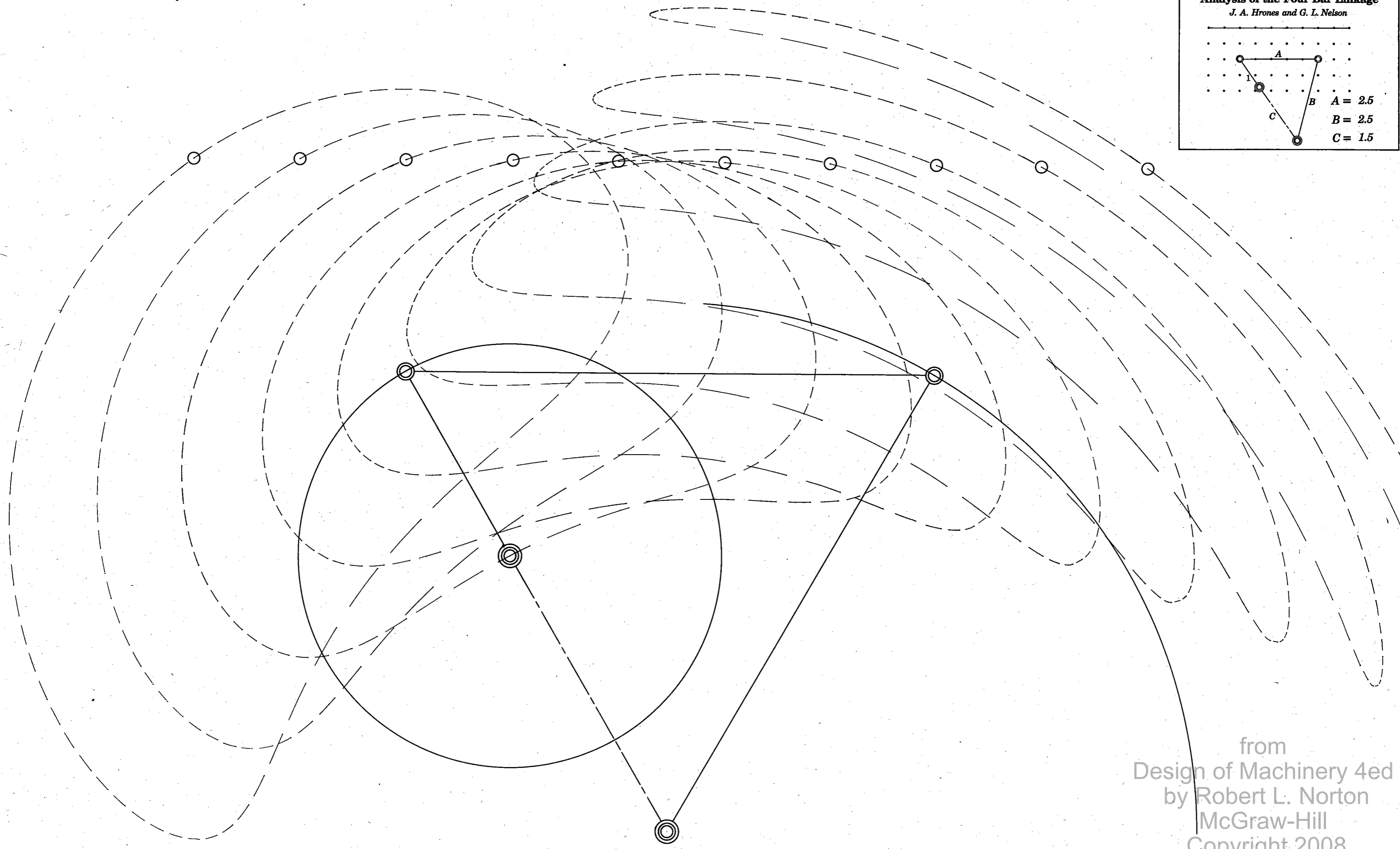
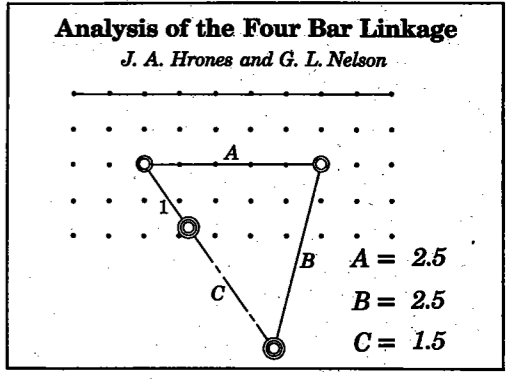

from  
 Design of Machinery 4ed  
 by Robert L. Norton  
 McGraw-Hill  
 Copyright 2008

**Analysis of the Four Bar Linkage**  
*J. A. Hrones and G. L. Nelson*

.....

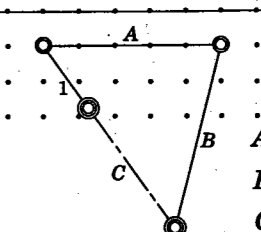

$A = 2.5$   
 $B = 2.5$   
 $C = 1.5$

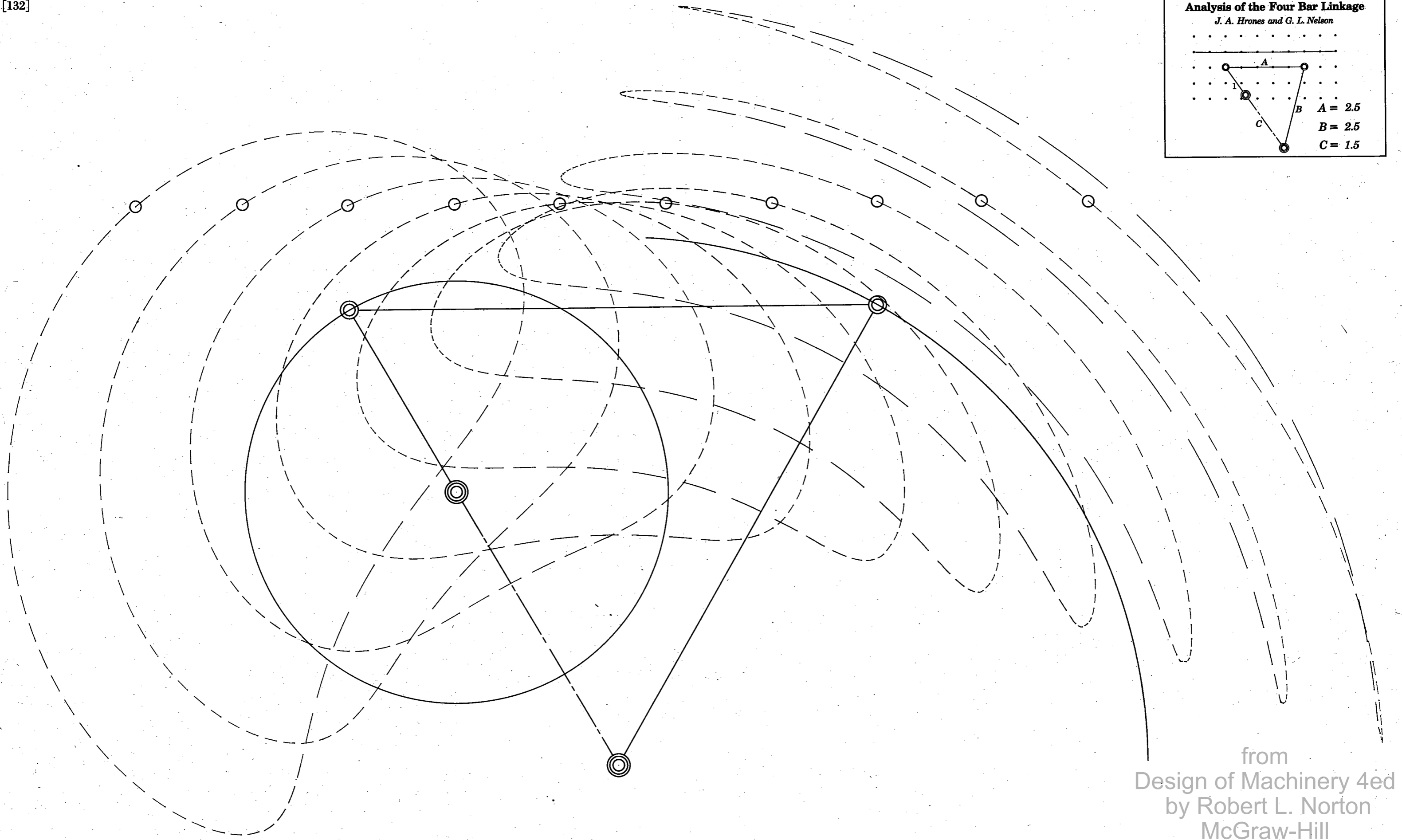

from  
Design of Machinery 4ed  
by Robert L. Norton  
McGraw-Hill  
Copyright 2008

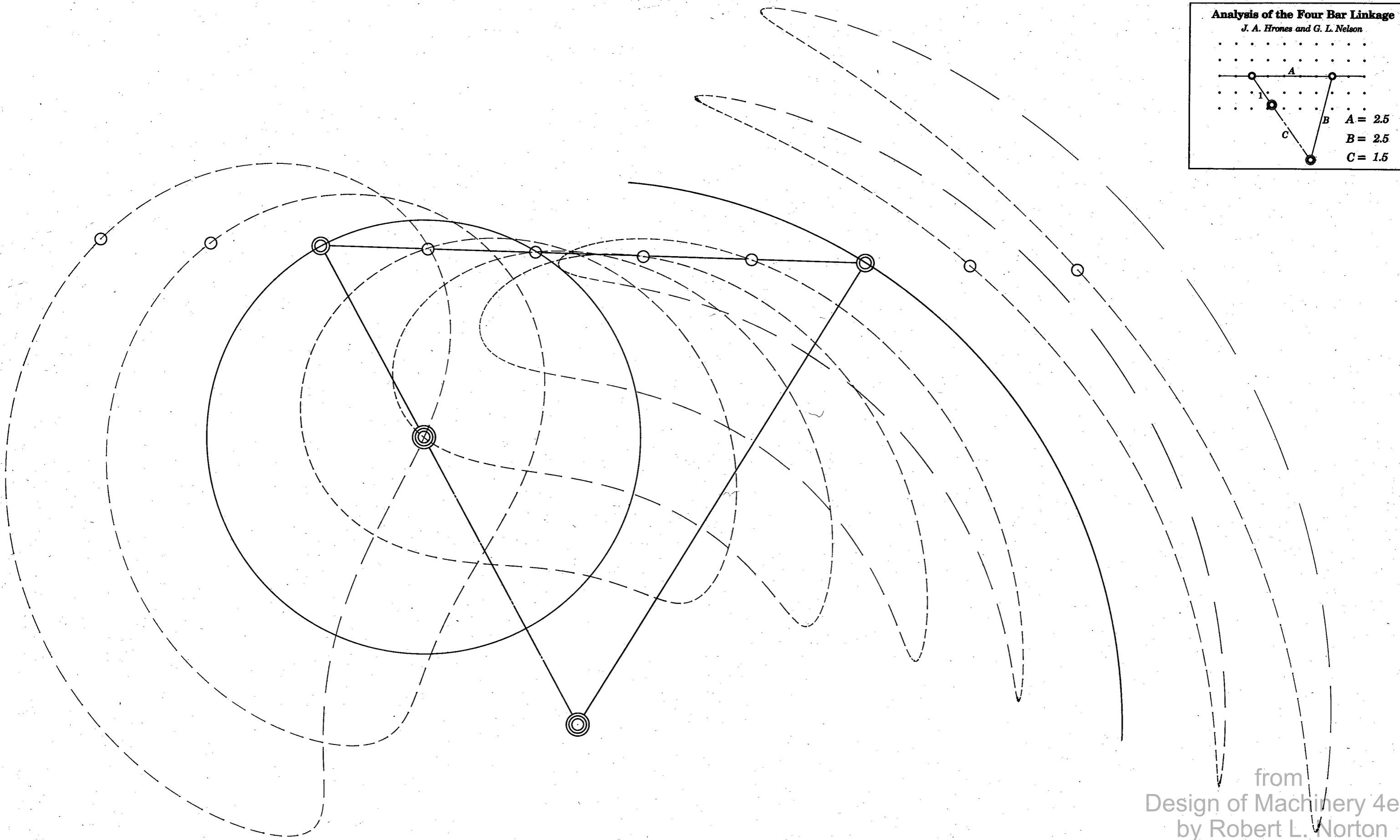
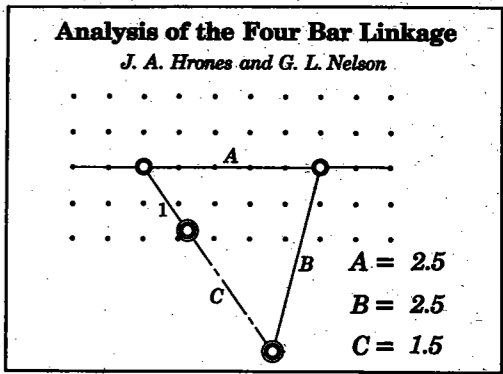

from  
 Design of Machinery 4ed  
 by Robert L. Norton  
 McGraw-Hill  
 Copyright 2008

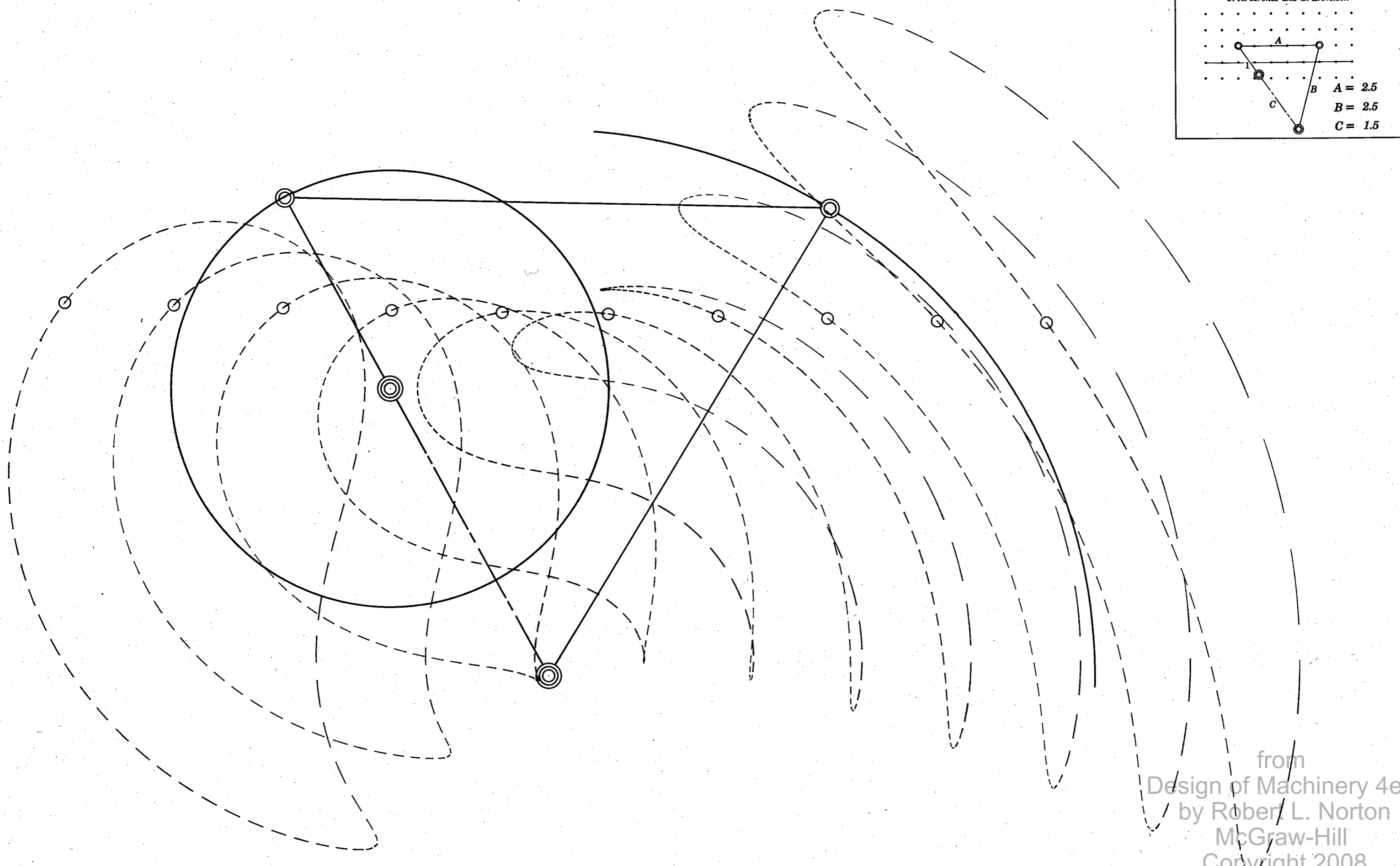
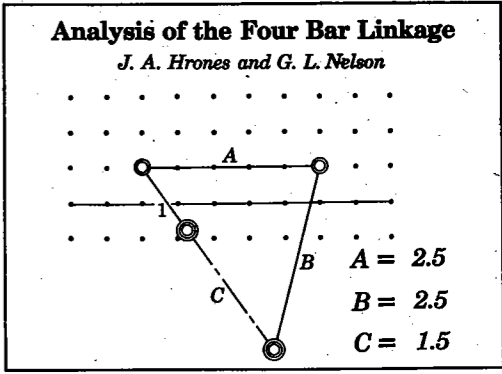

from  
Design of Machinery 4ed  
by Robert L. Norton  
McGraw-Hill  
Copyright 2008

**Analysis of the Four Bar Linkage**  
*J. A. Hrones and G. L. Nelson*

$A = 2.5$   
 $B = 2.5$   
 $C = 1.5$

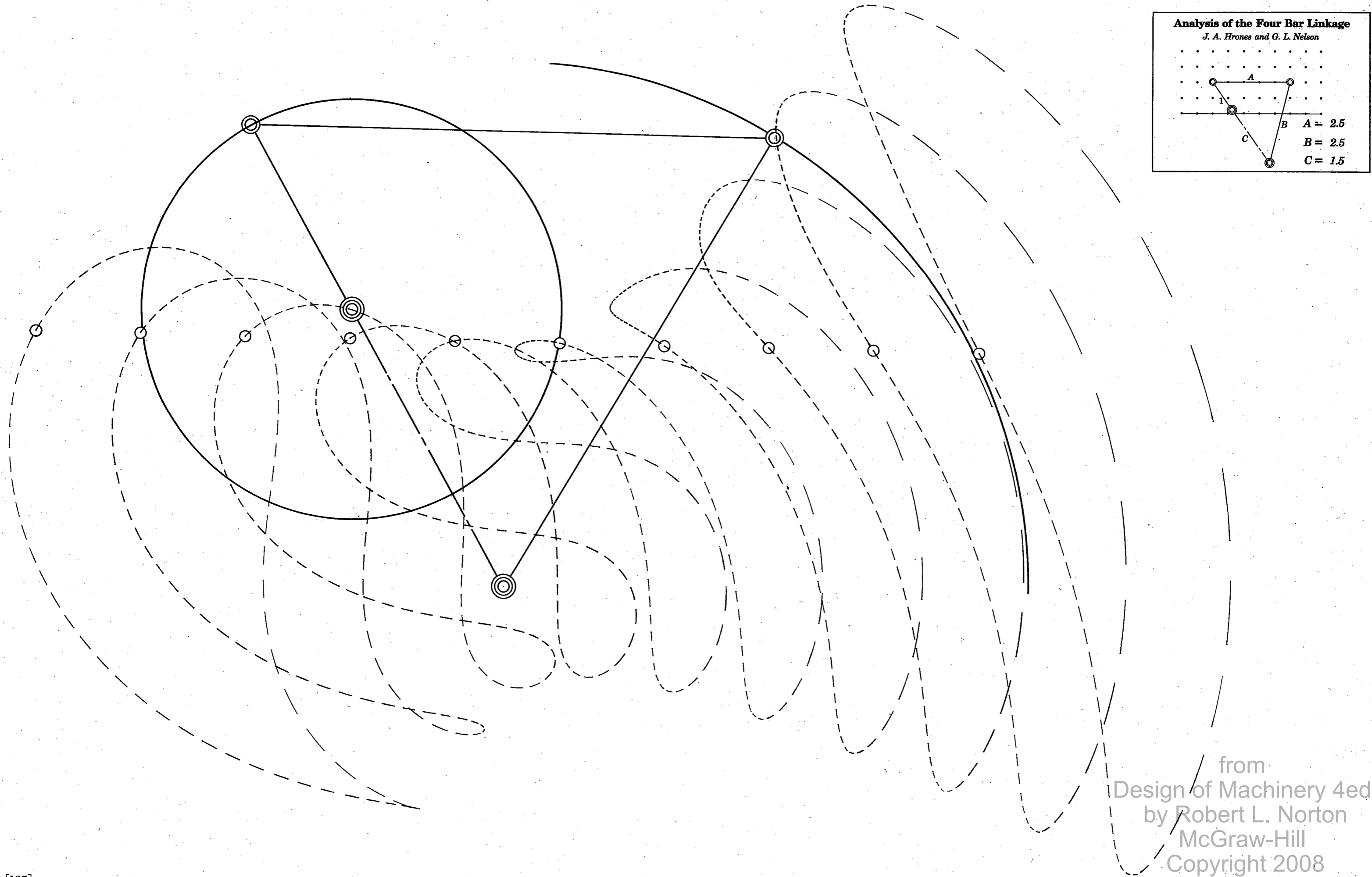

from  
 Design of Machinery 4ed  
 by Robert L. Norton  
 McGraw-Hill  
 Copyright 2008

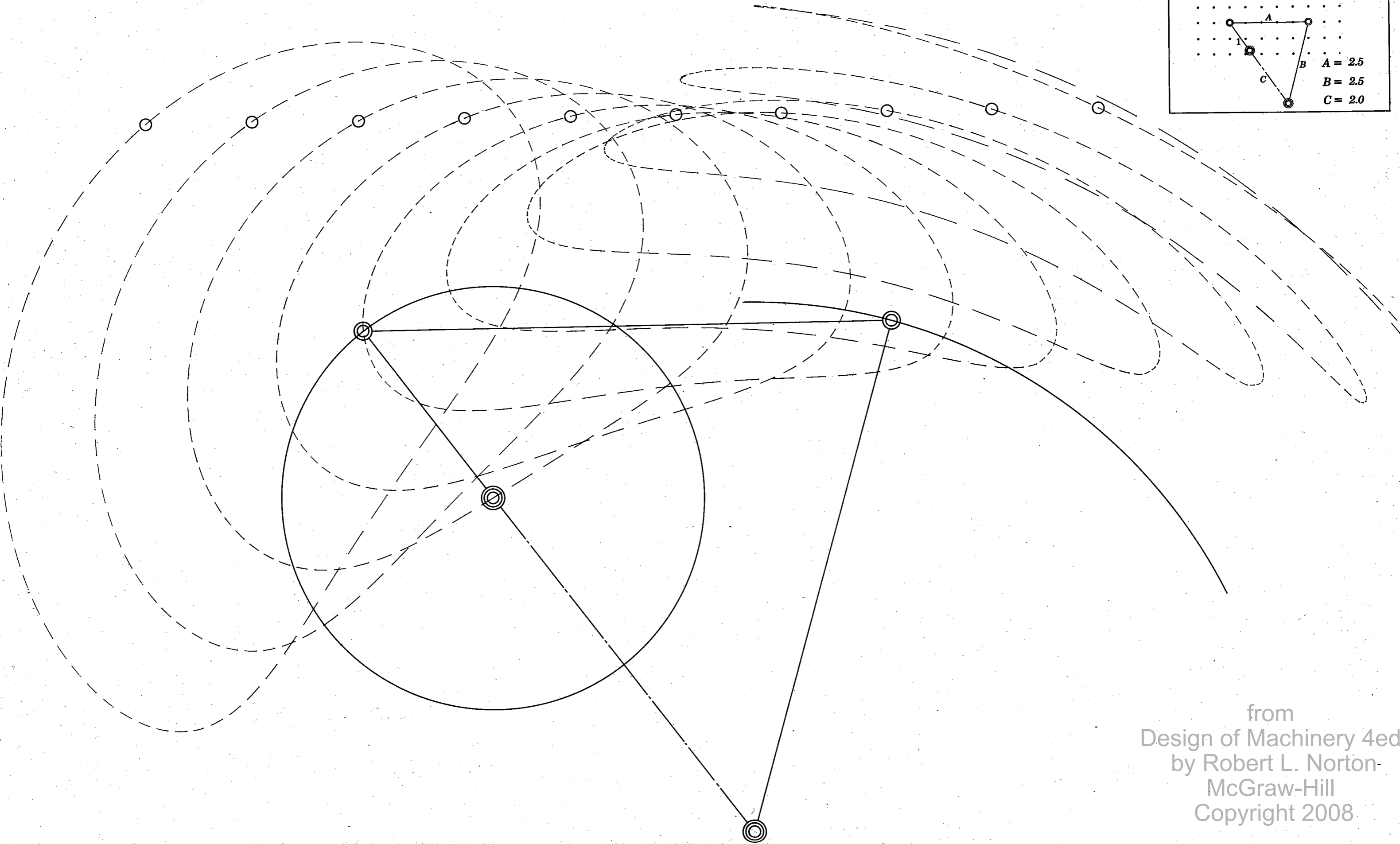
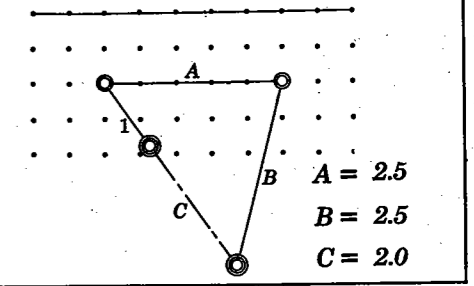

from  
Design of Machinery 4ed  
by Robert L. Norton  
McGraw-Hill  
Copyright 2008

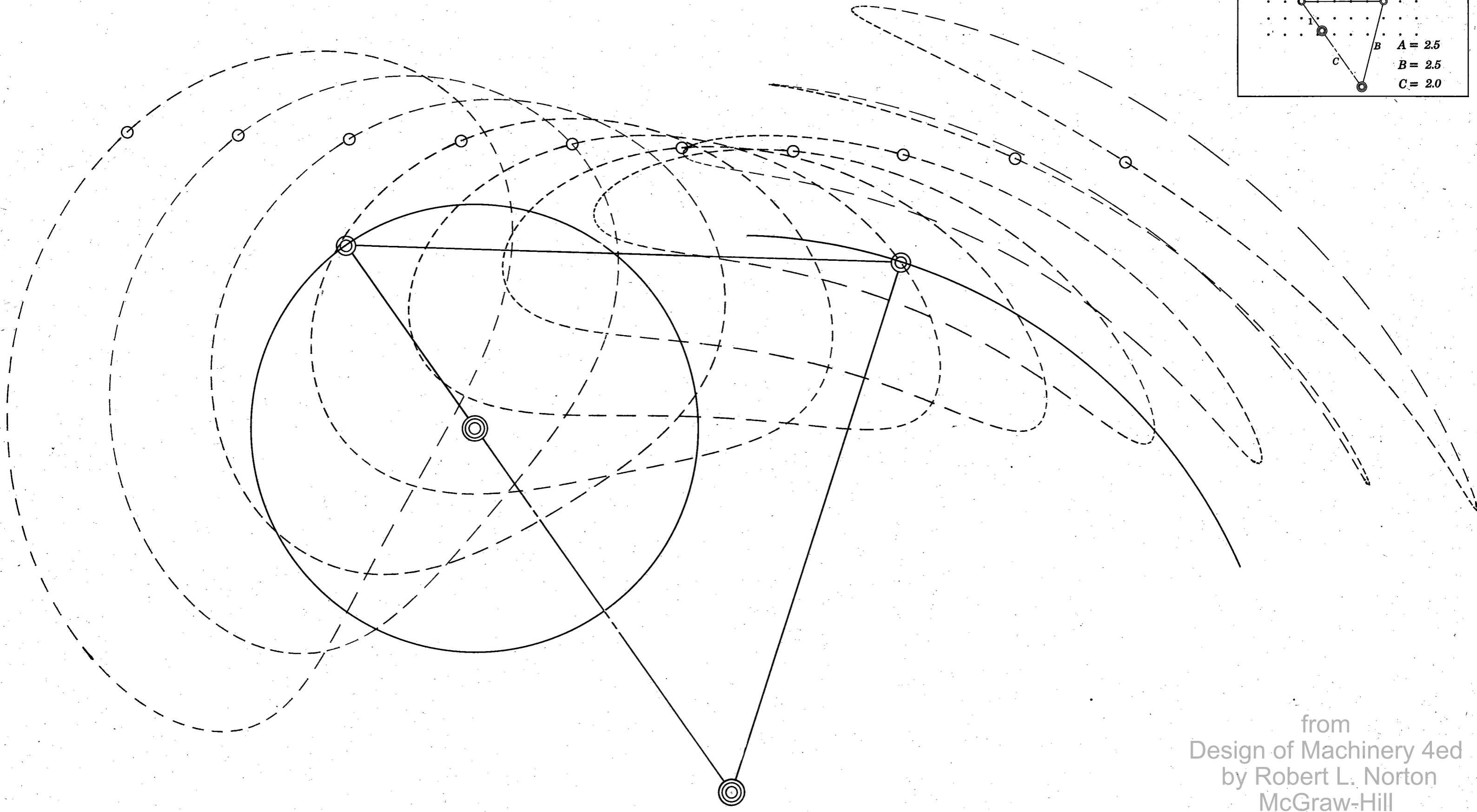
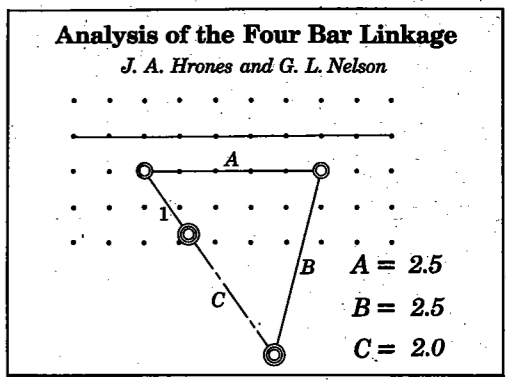

from  
 Design of Machinery 4ed  
 by Robert L. Norton  
 McGraw-Hill  
 Copyright 2008



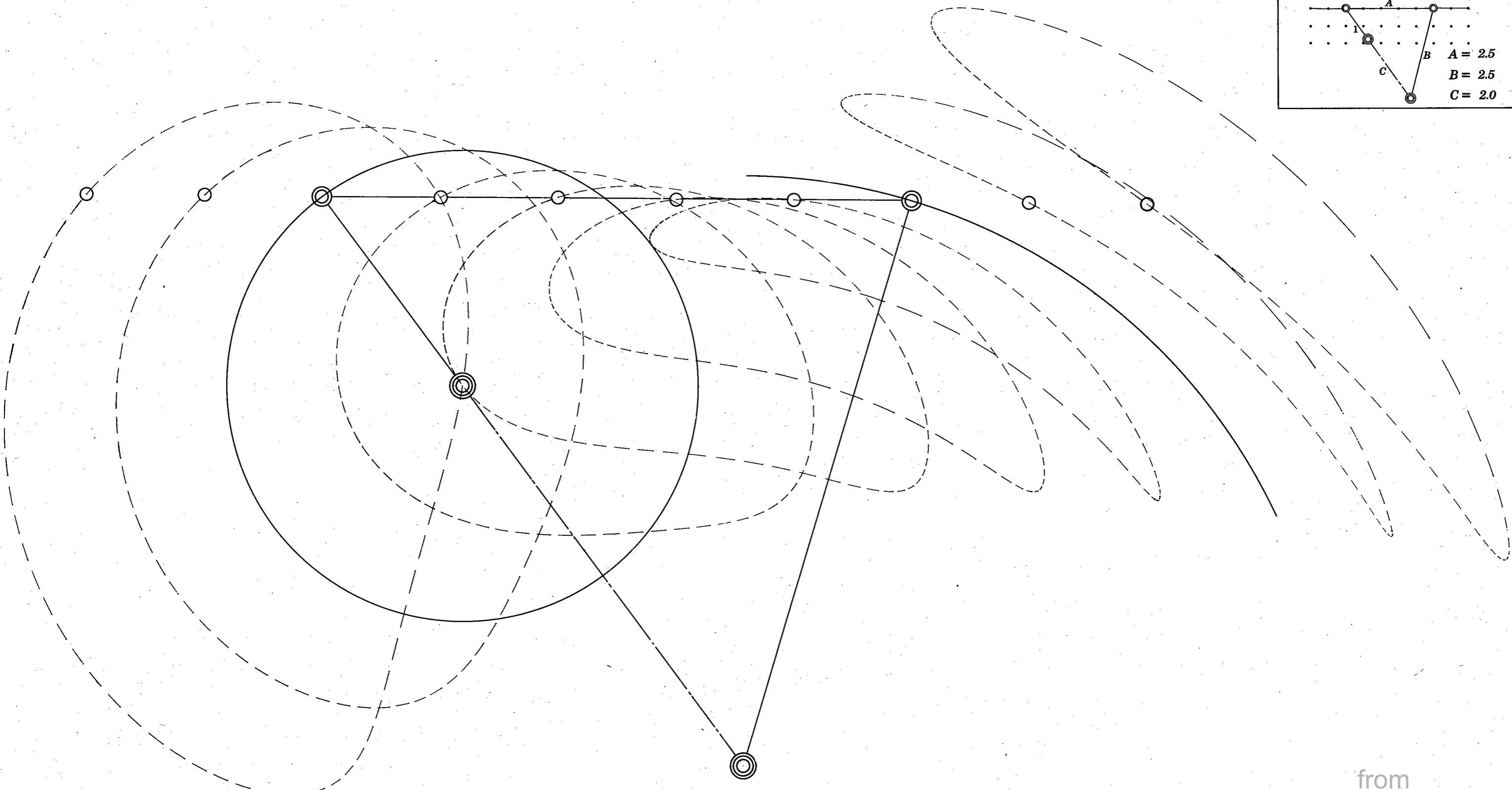
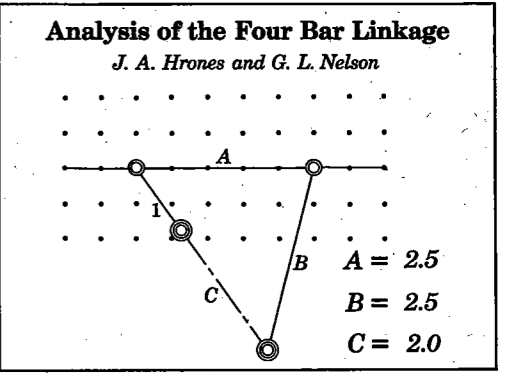

from  
Design of Machinery 4ed  
by Robert L. Norton  
McGraw-Hill  
Copyright 2008

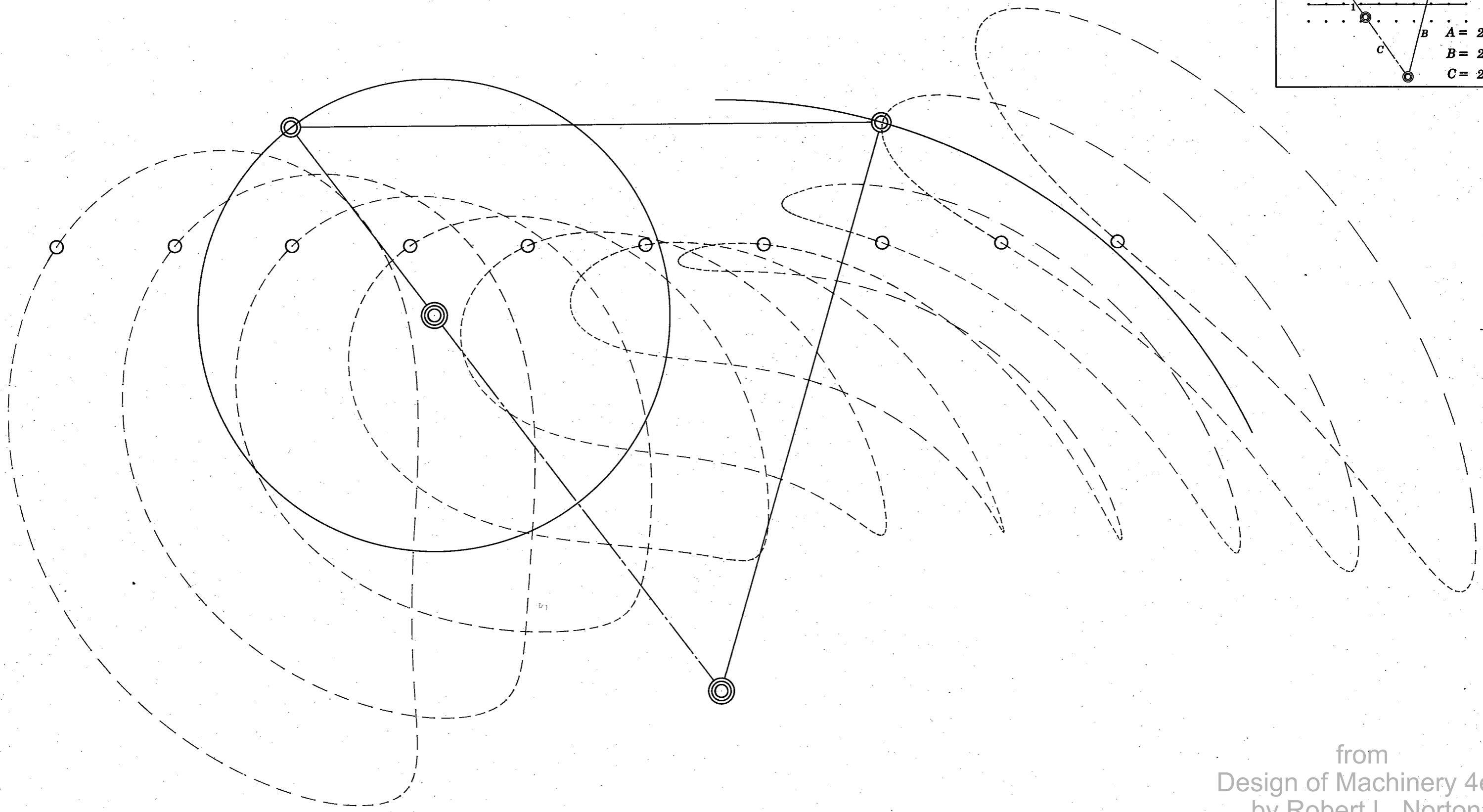
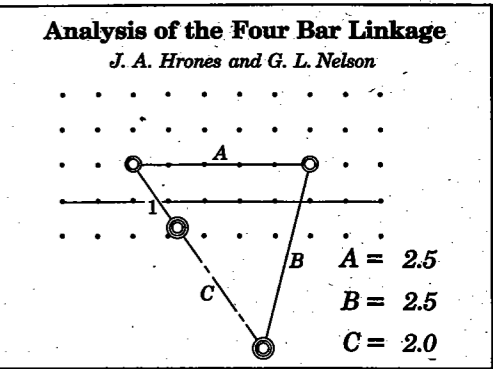

from  
 Design of Machinery 4ed  
 by Robert L. Norton  
 McGraw-Hill  
 Copyright 2008

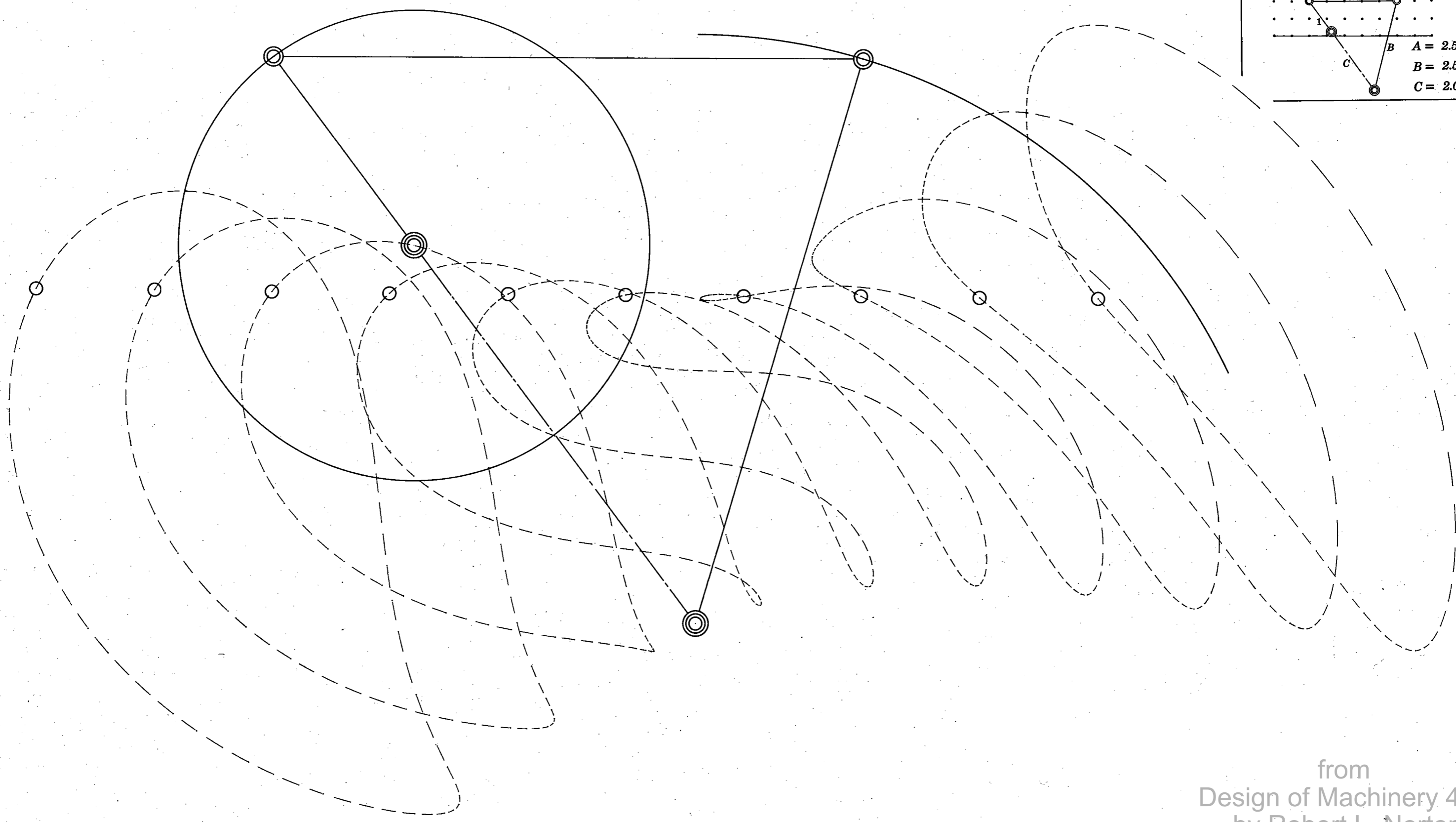
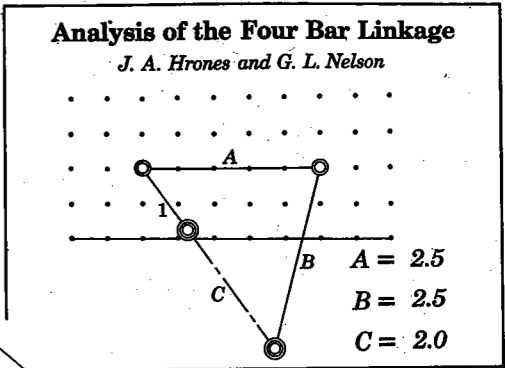

from  
Design of Machinery 4ed  
by Robert L. Norton  
McGraw-Hill  
Copyright 2008

**Analysis of the Four Bar Linkage**

*J. A. Hrones and G. L. Nelson*

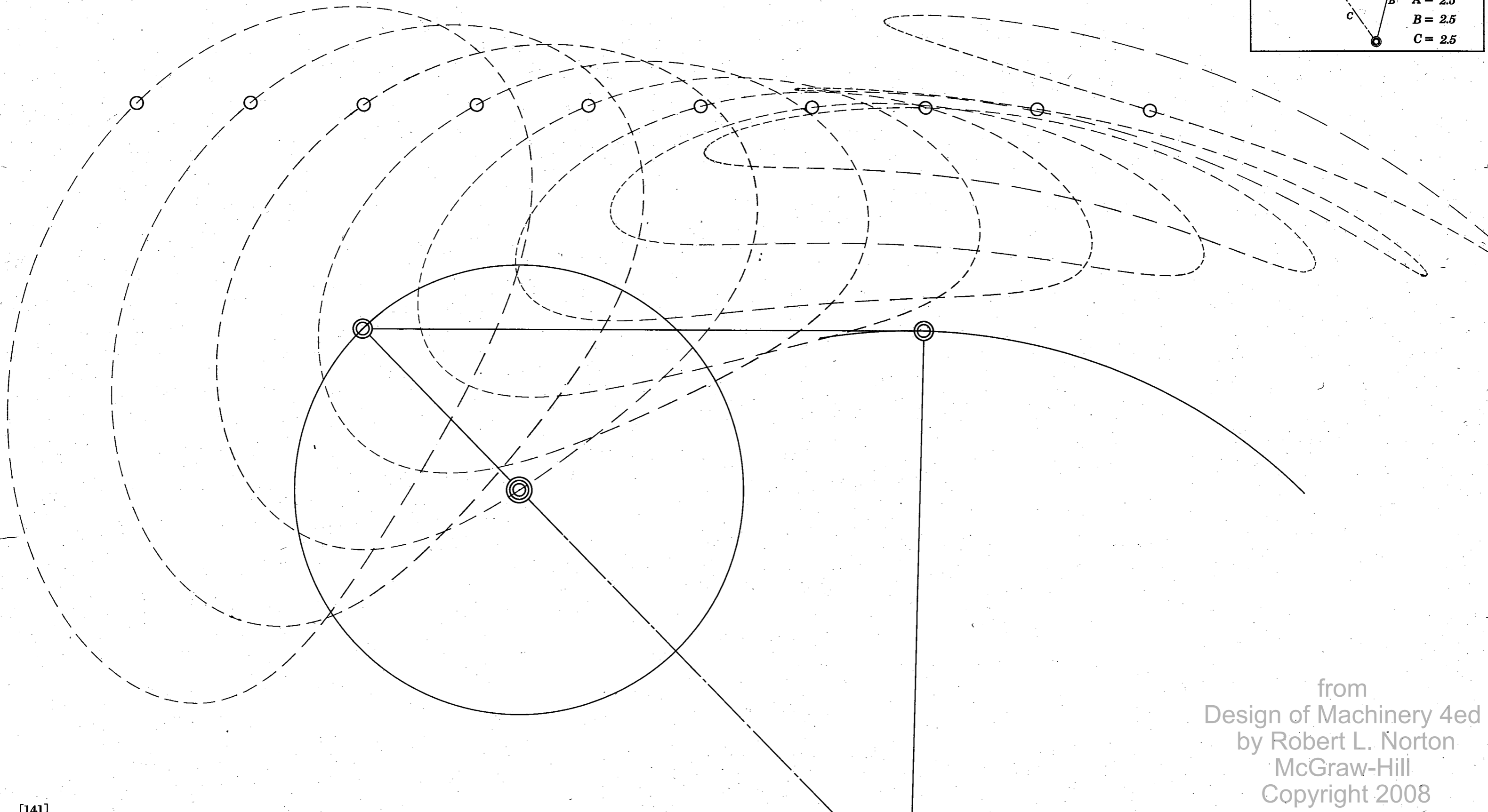
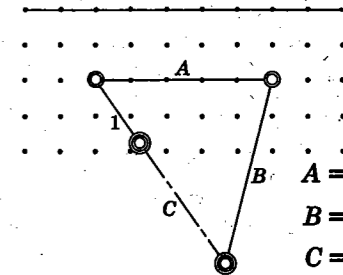

from  
Design of Machinery 4ed  
by Robert L. Norton  
McGraw-Hill  
Copyright 2008

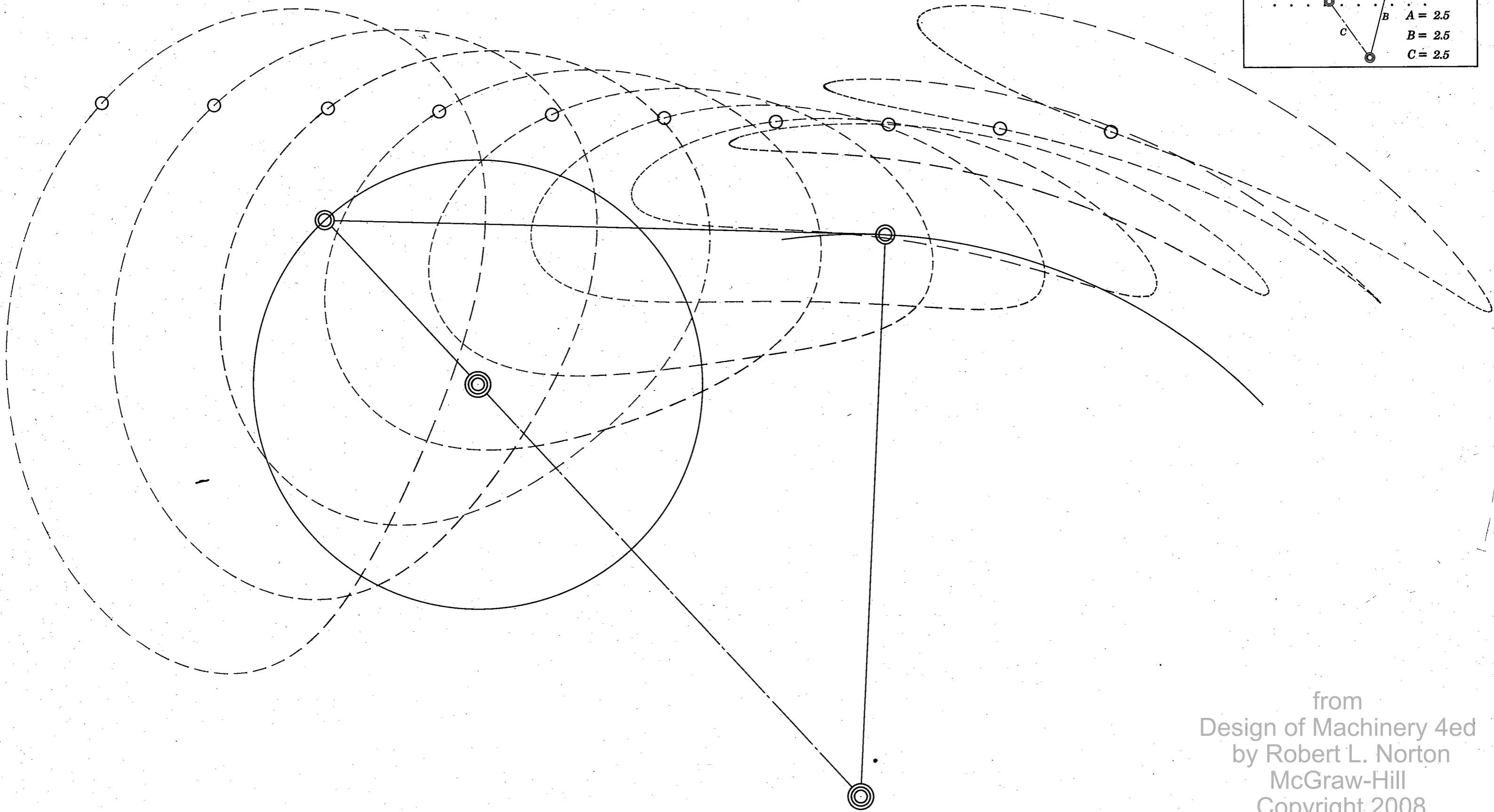
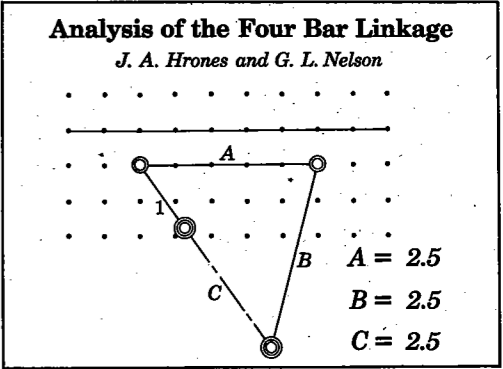

from  
Design of Machinery 4ed  
by Robert L. Norton  
McGraw-Hill  
Copyright 2008

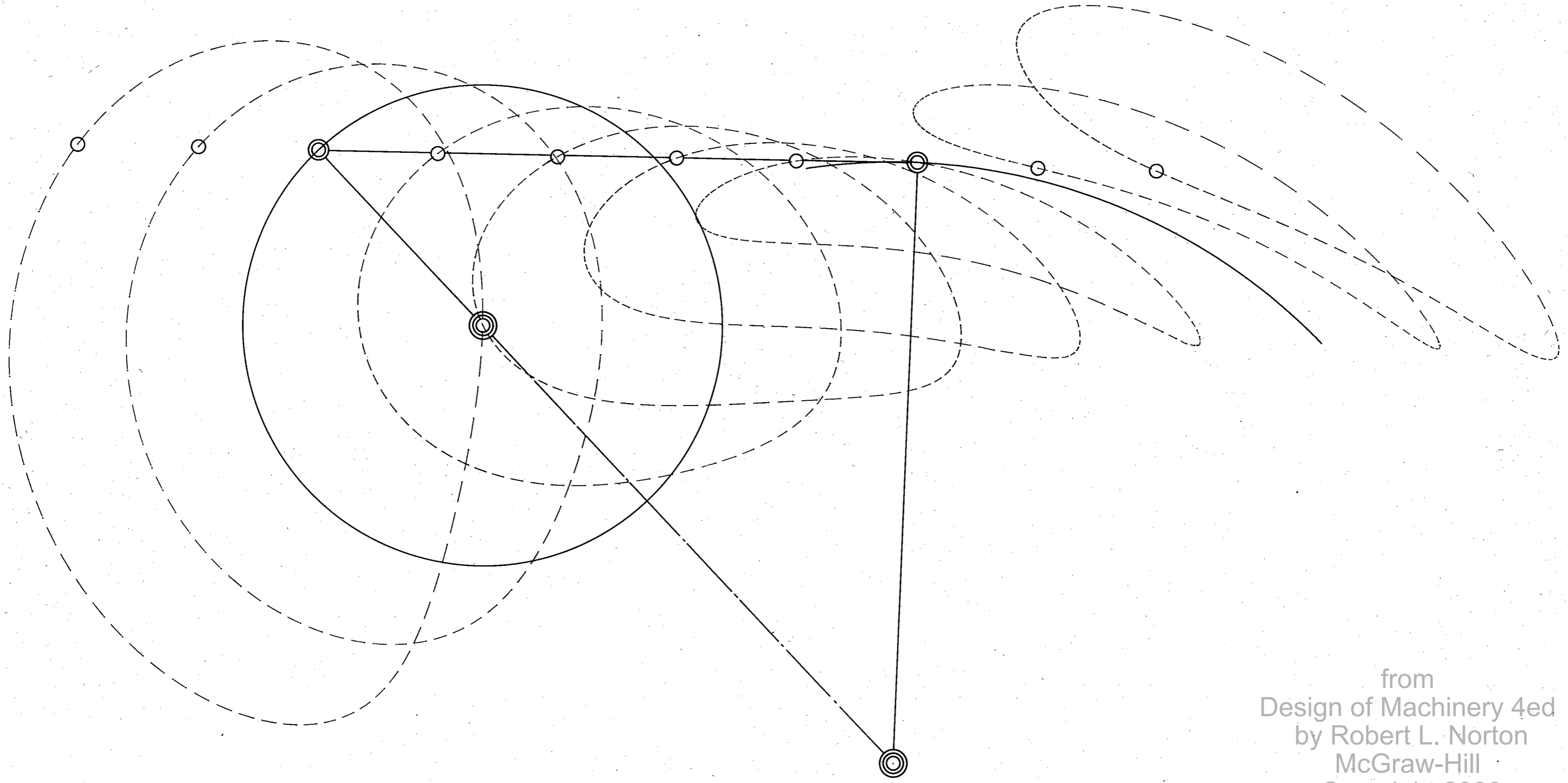
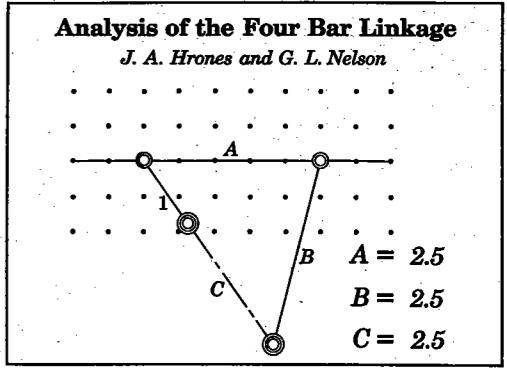

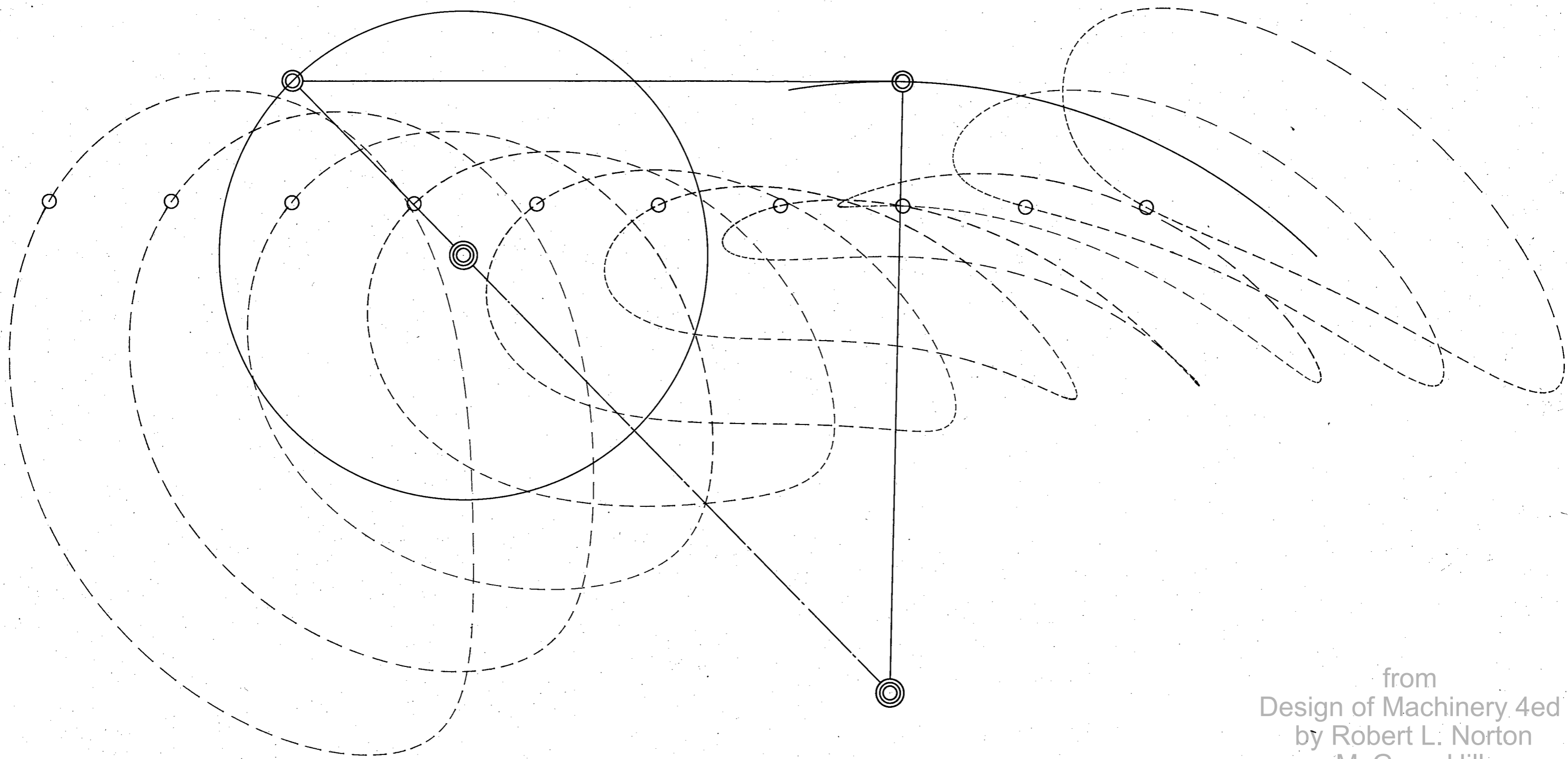
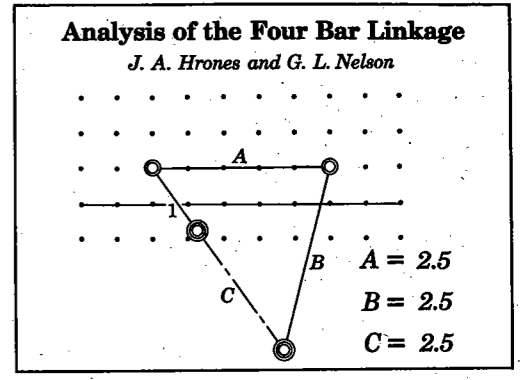

from  
Design of Machinery 4ed  
by Robert L. Norton  
McGraw-Hill  
Copyright 2008

**Analysis of the Four Bar Linkage**

*J. A. Hrones and G. L. Nelson*

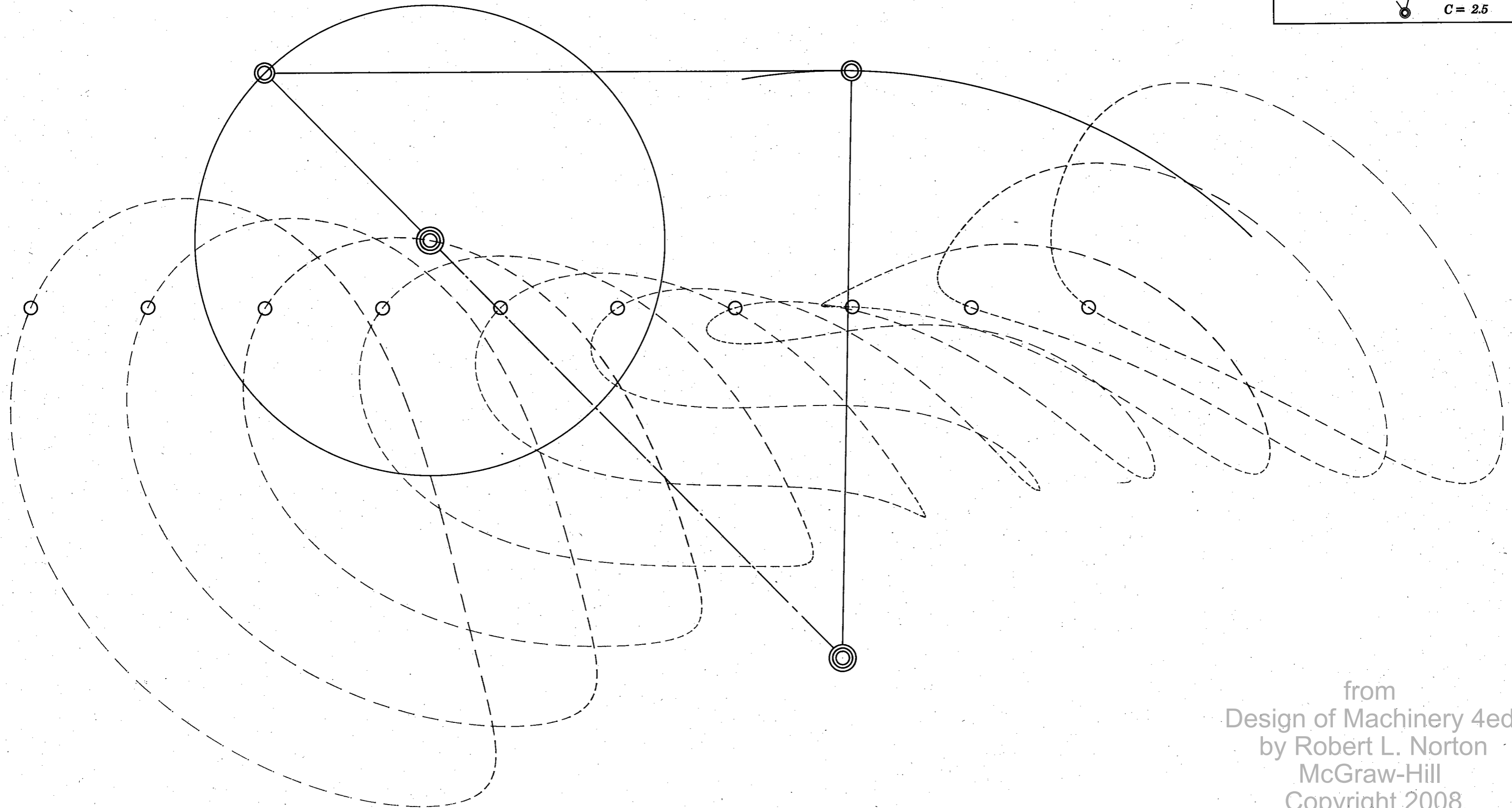
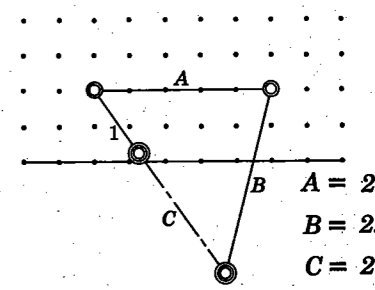

from  
Design of Machinery 4ed  
by Robert L. Norton  
McGraw-Hill  
Copyright 2008



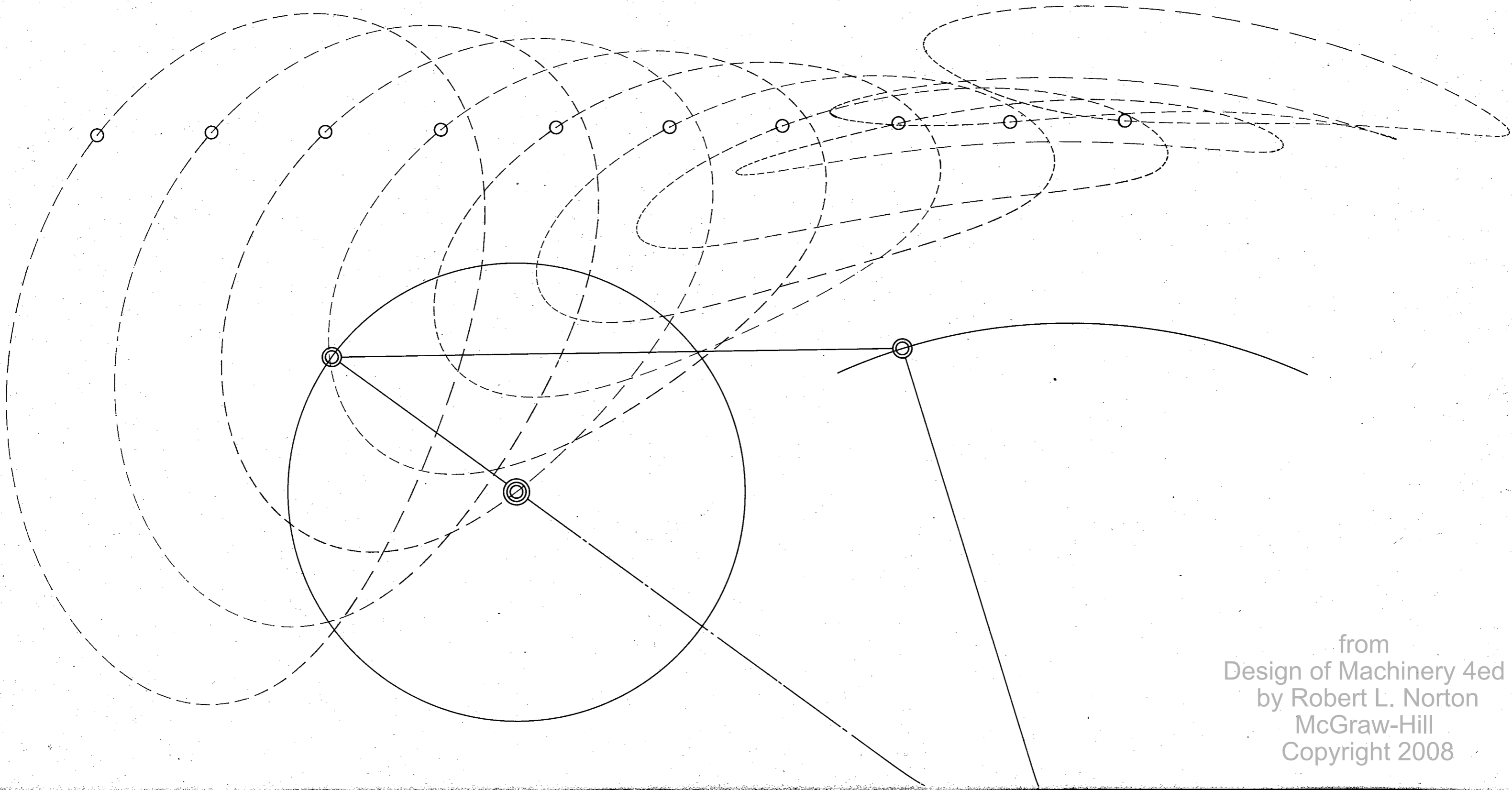
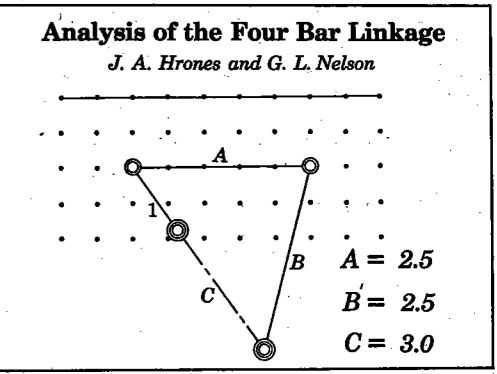

from  
Design of Machinery 4ed  
by Robert L. Norton  
McGraw-Hill  
Copyright 2008

**Analysis of the Four Bar Linkage**

*J. A. Hrones and G. L. Nelson*

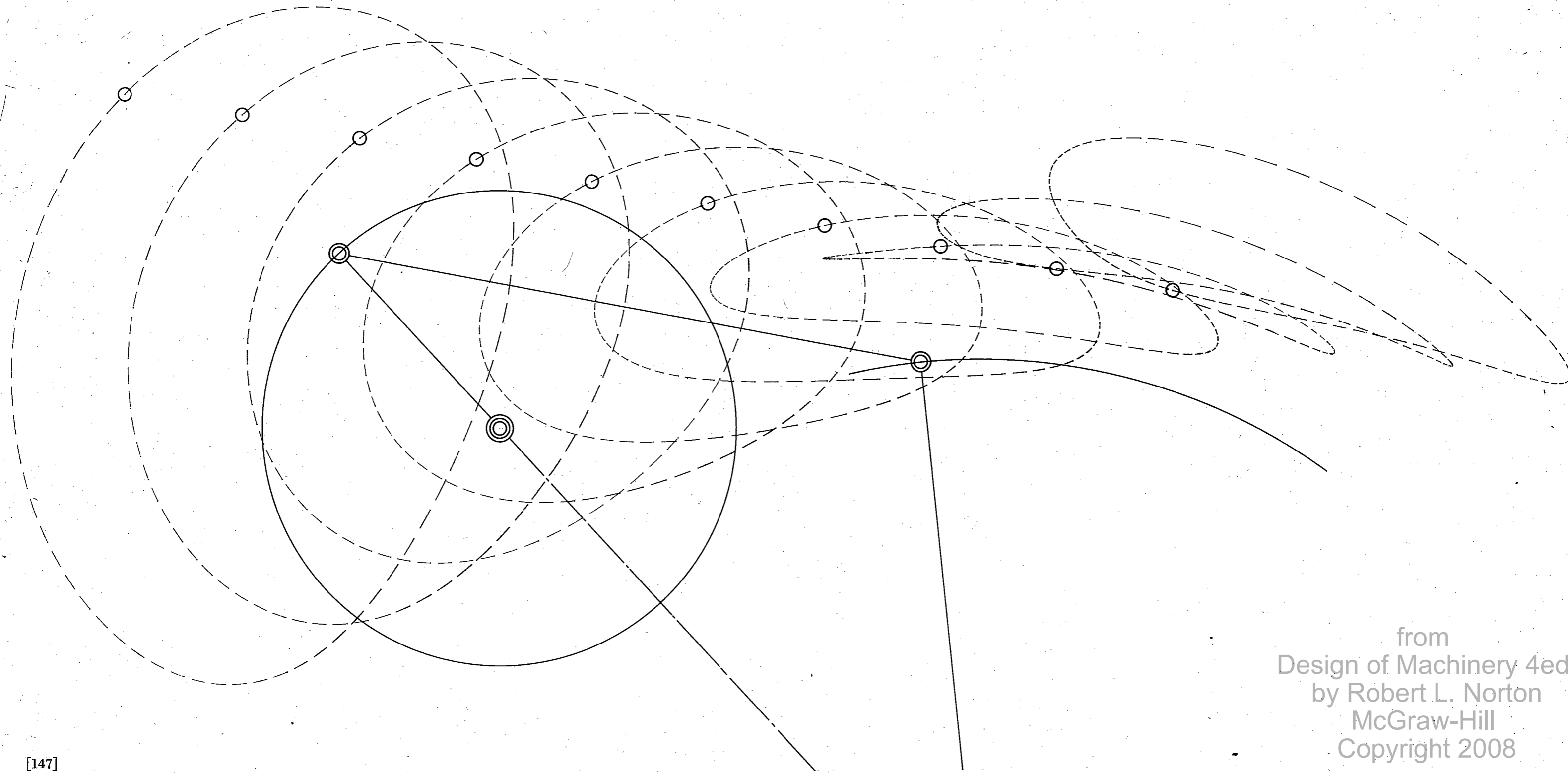
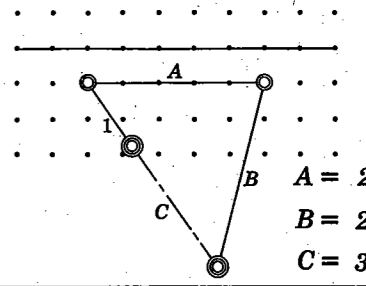

from  
Design of Machinery 4ed  
by Robert L. Norton  
McGraw-Hill  
Copyright 2008

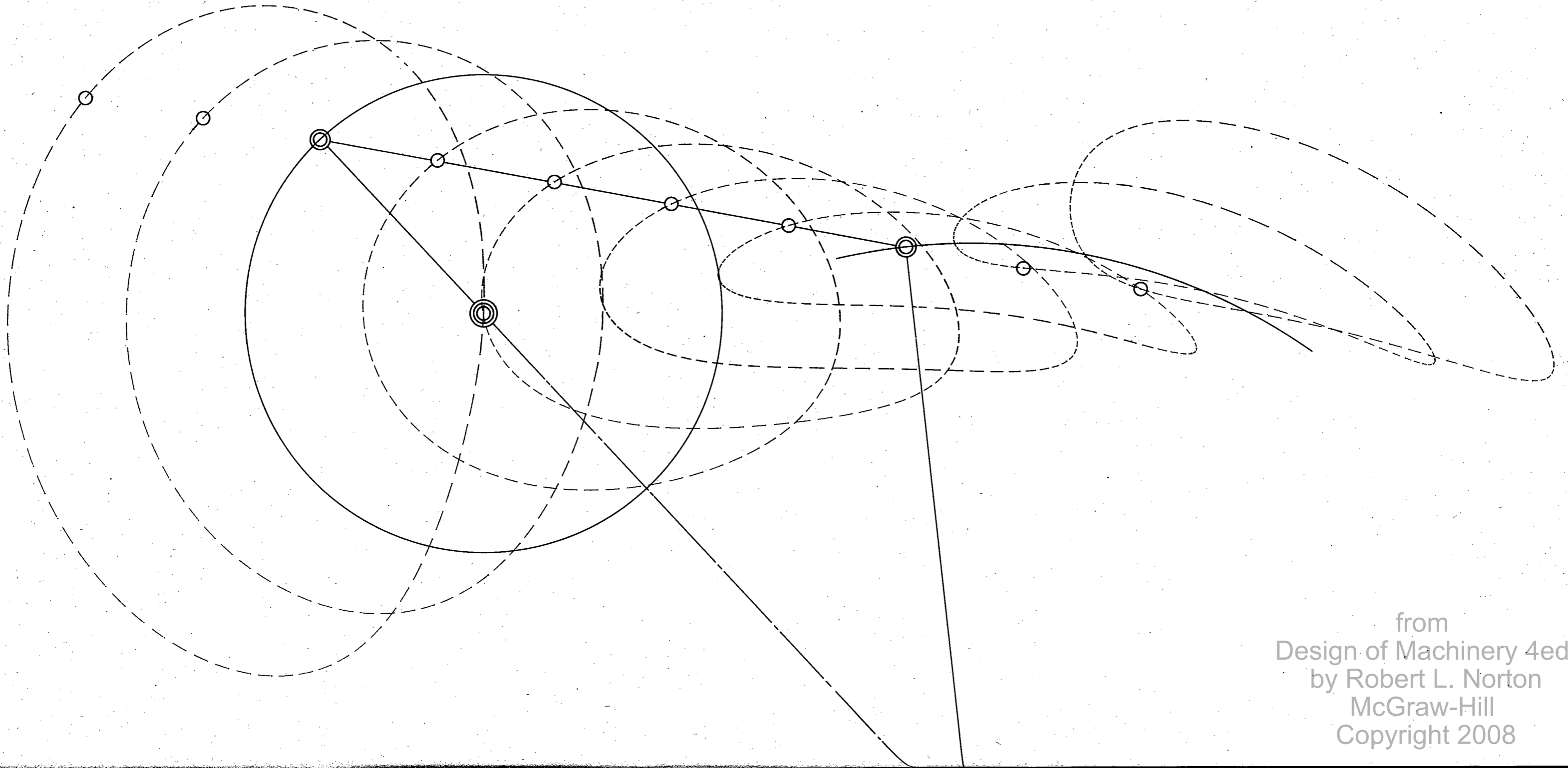
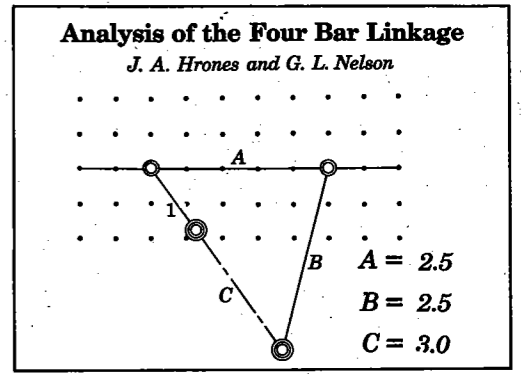

from  
Design of Machinery 4ed  
by Robert L. Norton  
McGraw-Hill  
Copyright 2008

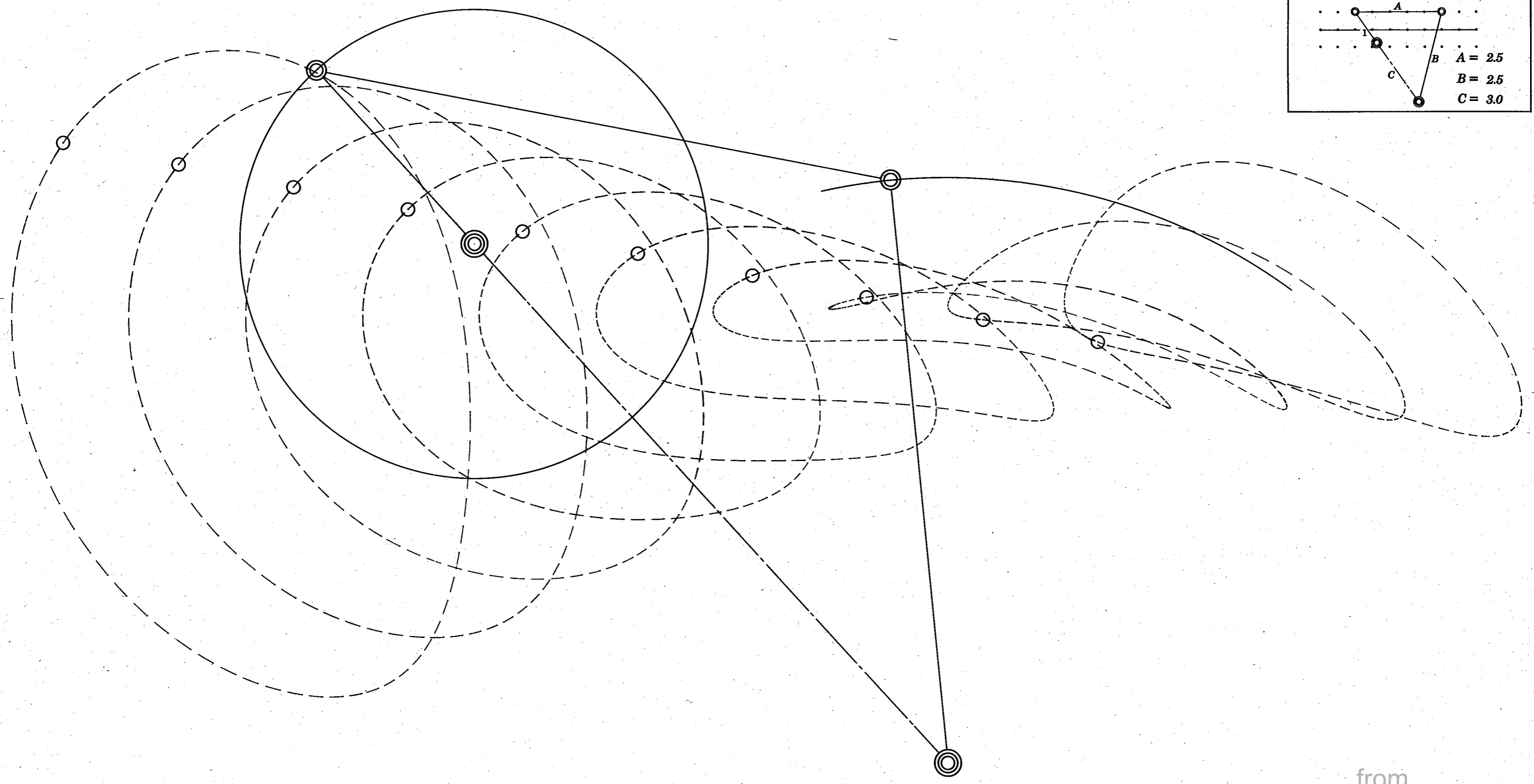
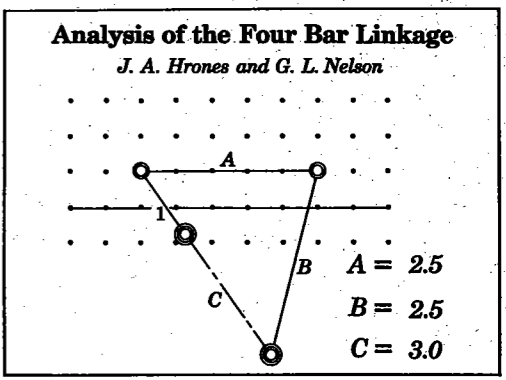

from  
 Design of Machinery 4ed  
 by Robert L. Norton  
 McGraw-Hill  
 Copyright 2008

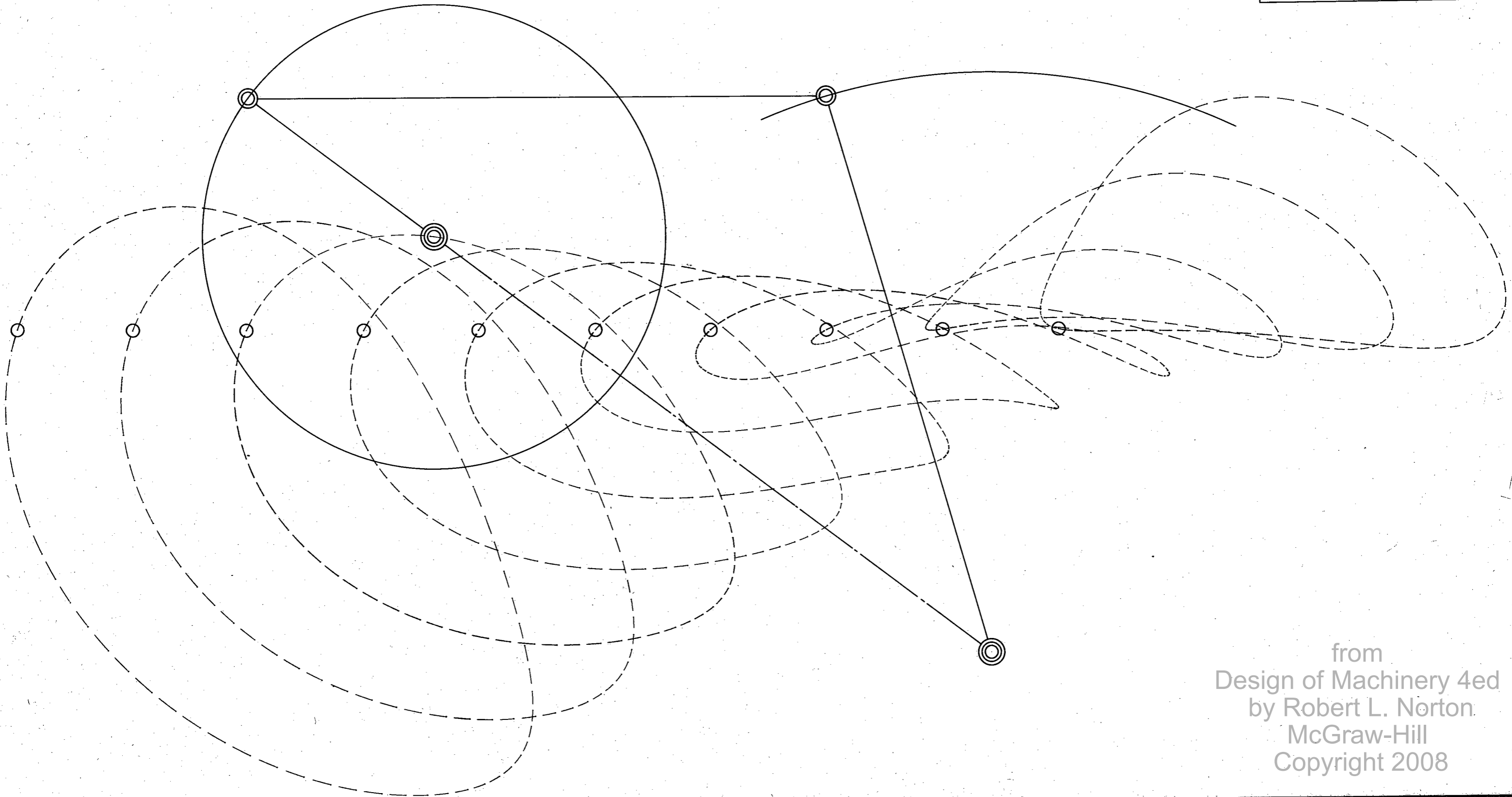
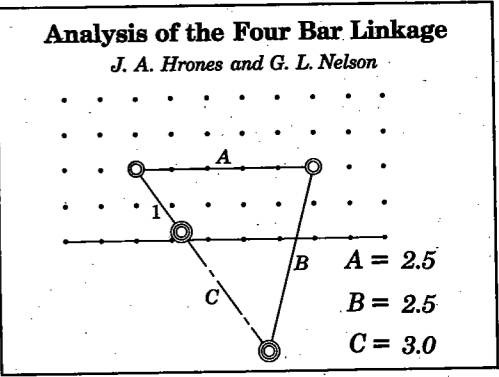

from  
Design of Machinery 4ed  
by Robert L. Norton  
McGraw-Hill  
Copyright 2008

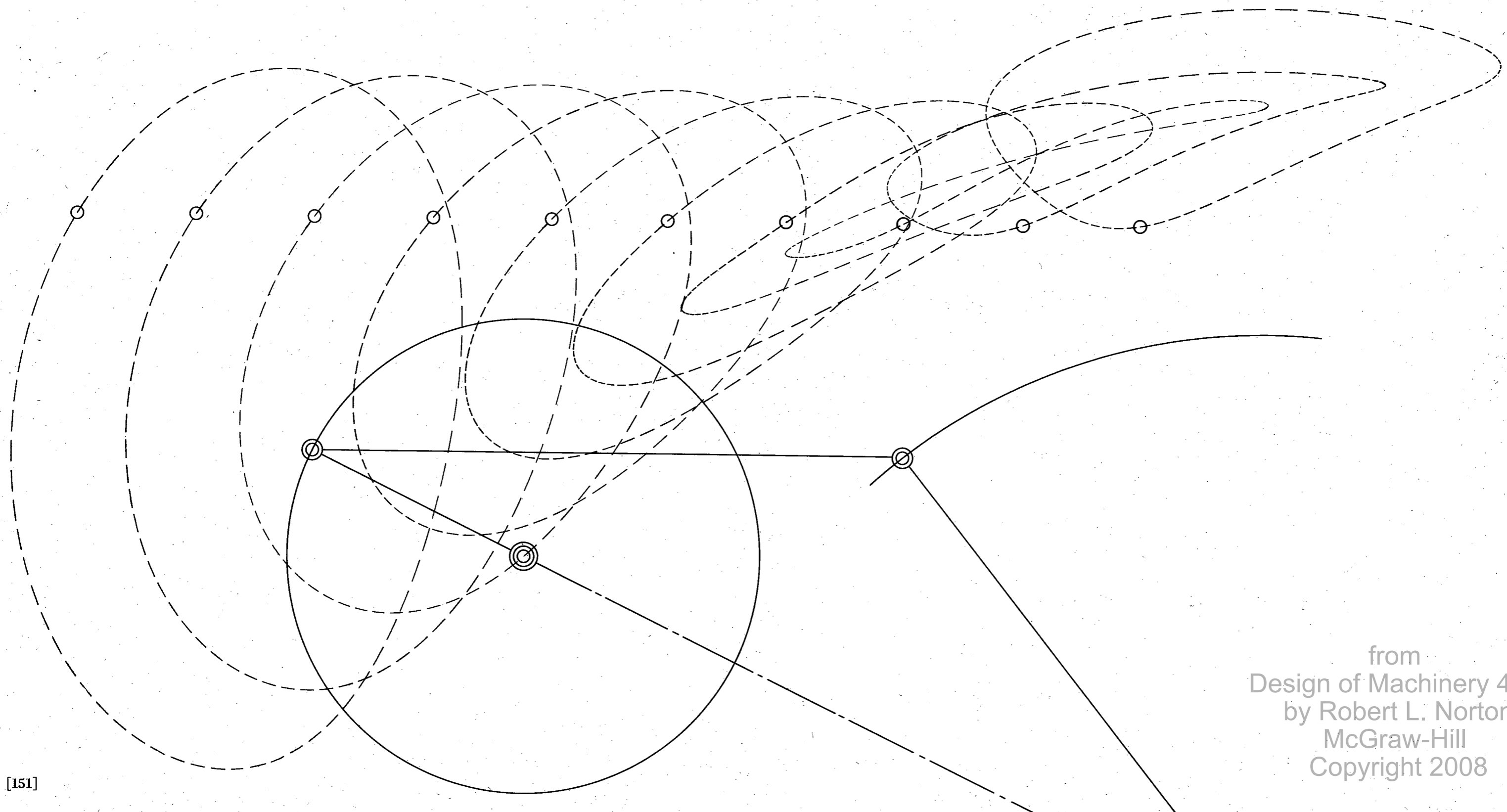
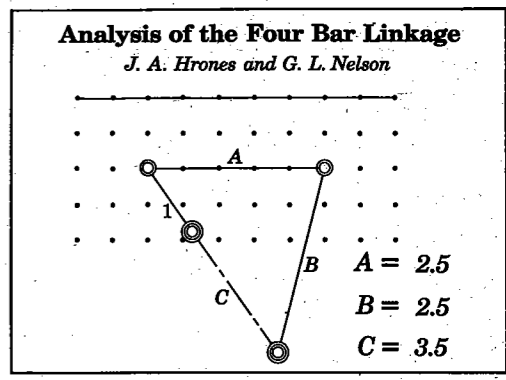

from  
 Design of Machinery 4ed  
 by Robert L. Norton  
 McGraw-Hill  
 Copyright 2008

**Analysis of the Four Bar Linkage**  
*J. A. Hrones and G. L. Nelson*

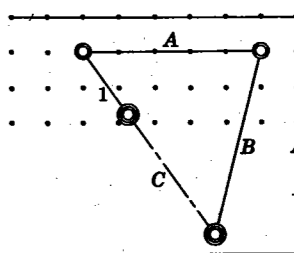

$A = 2.5$   
 $B = 2.5$   
 $C = 3.5$

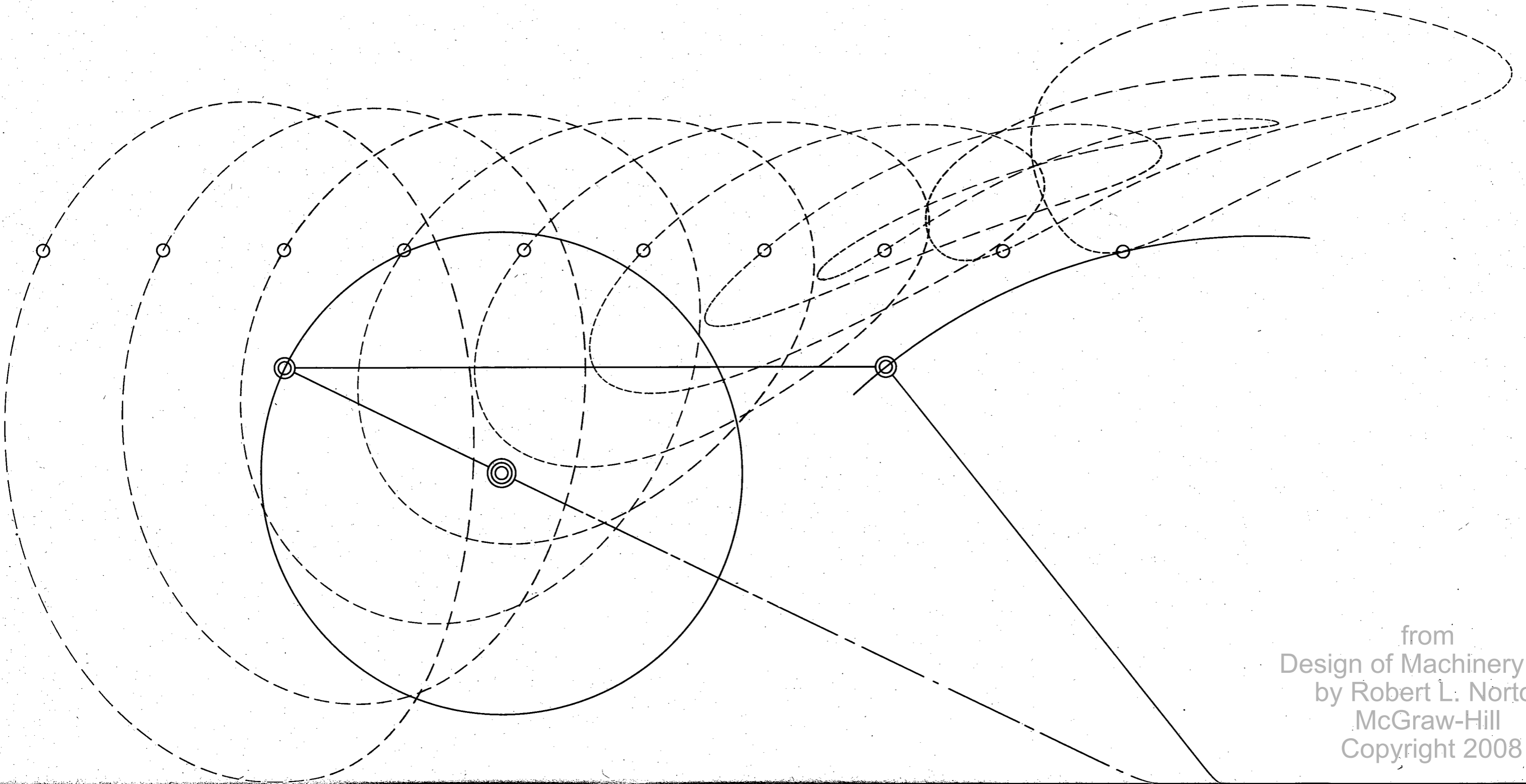

from  
Design of Machinery 4ed  
by Robert L. Norton  
McGraw-Hill  
Copyright 2008

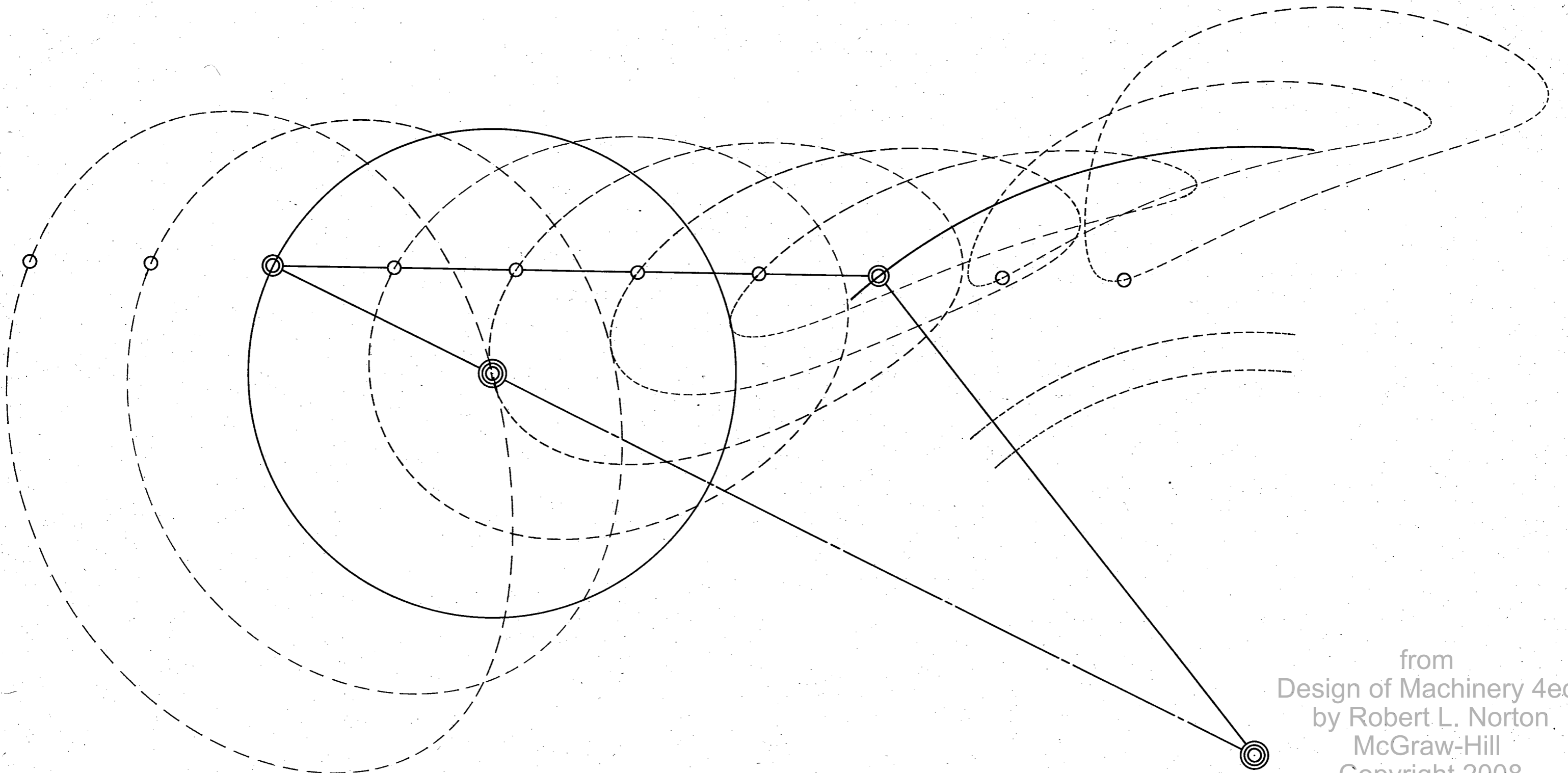
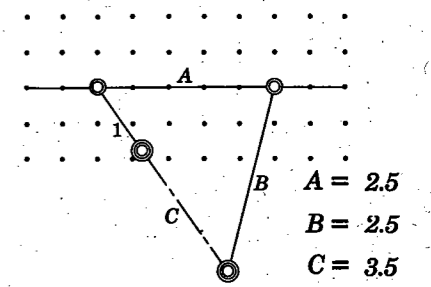

from  
Design of Machinery 4ed  
by Robert L. Norton  
McGraw-Hill  
Copyright 2008



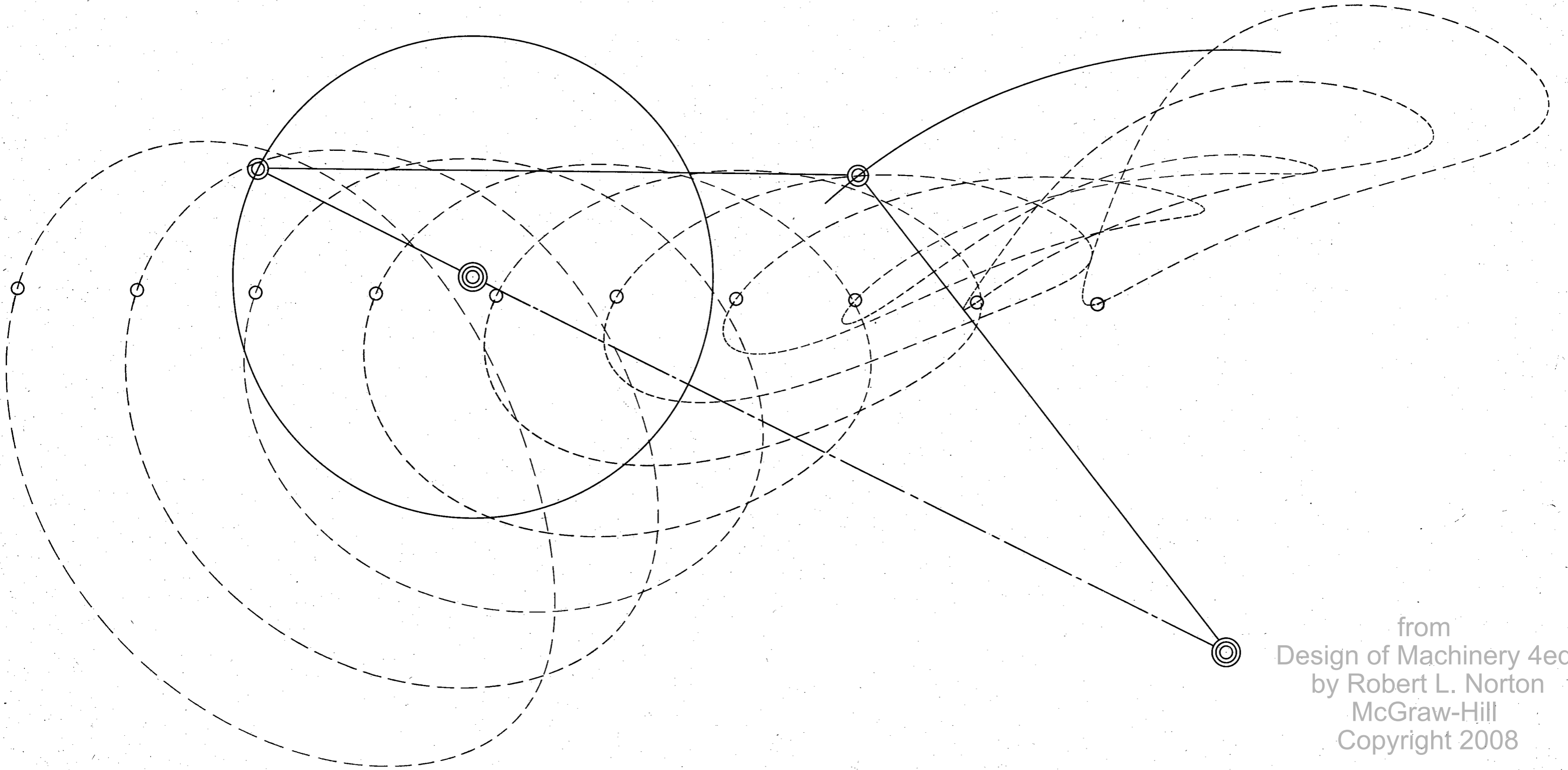
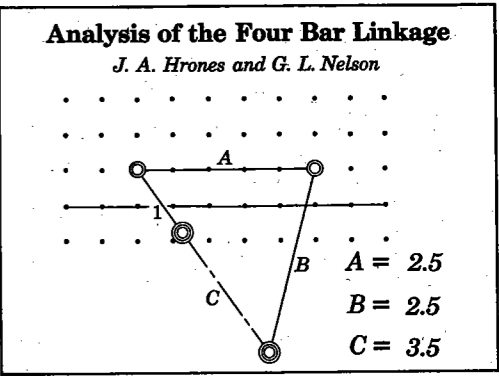

from  
Design of Machinery 4ed  
by Robert L. Norton  
McGraw-Hill  
Copyright 2008

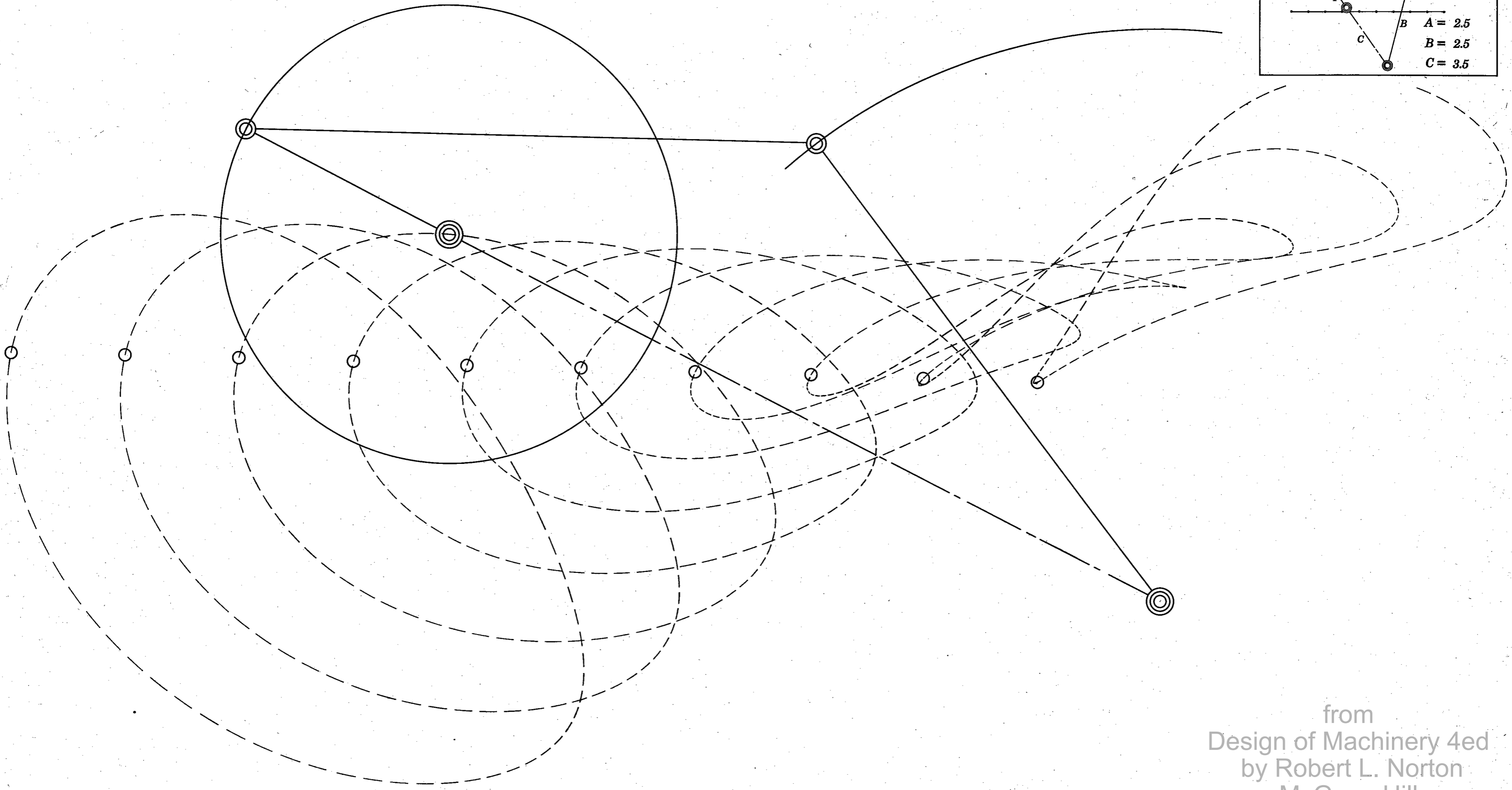
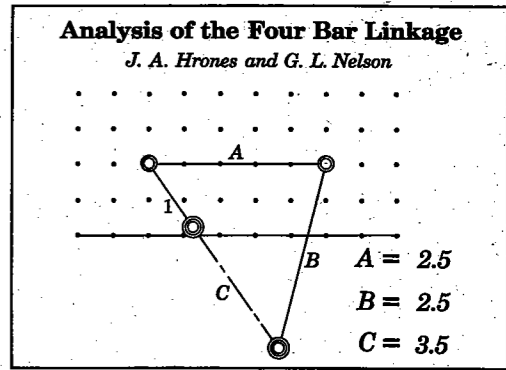

from  
 Design of Machinery 4ed  
 by Robert L. Norton  
 McGraw-Hill  
 Copyright 2008

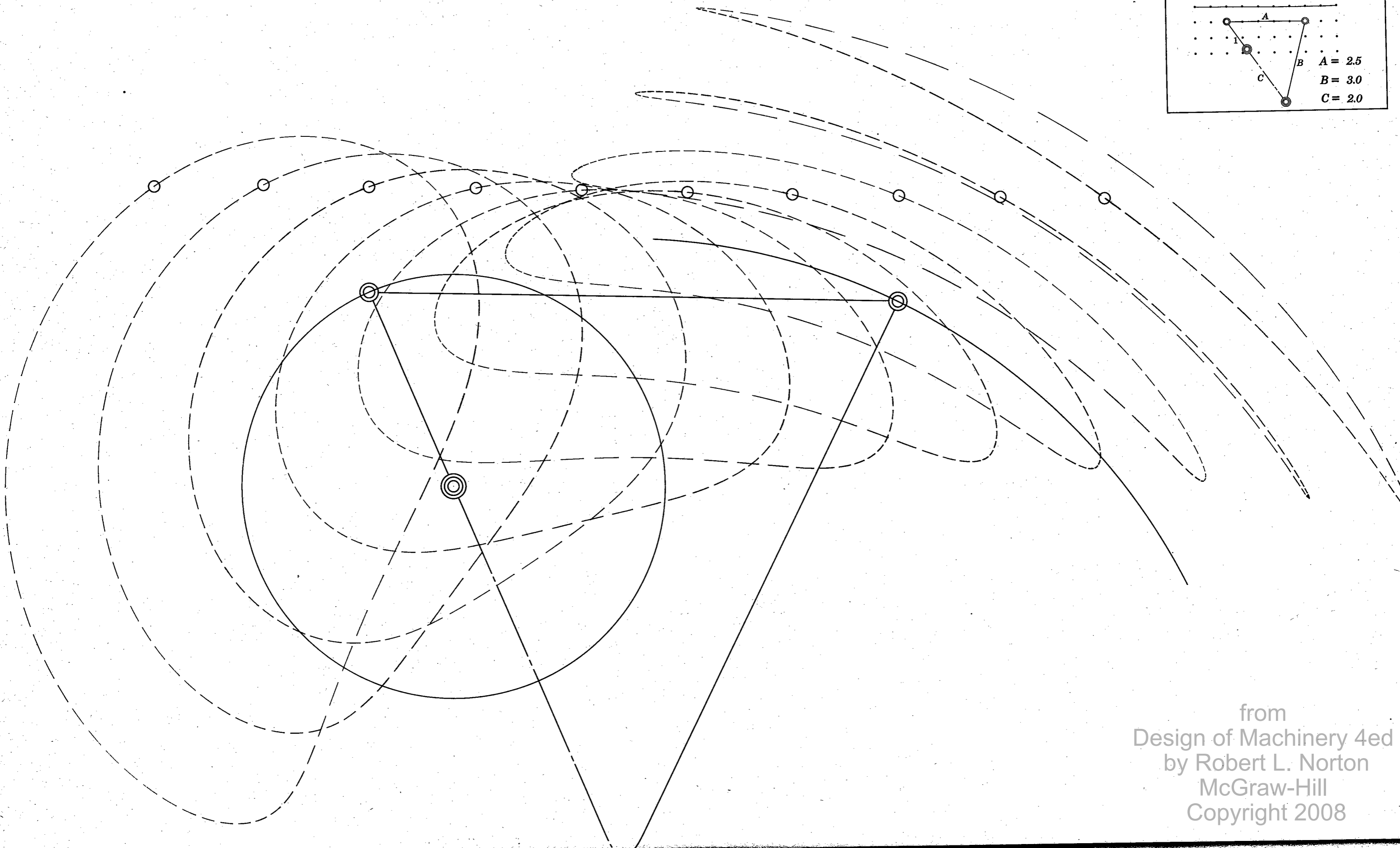
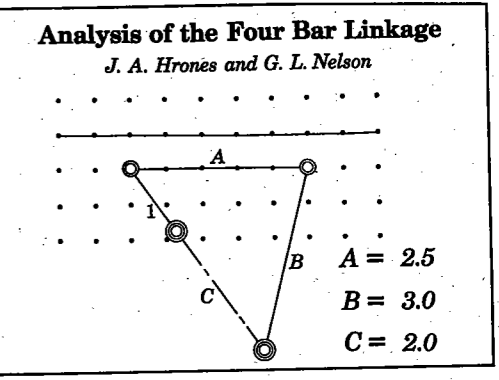

from  
Design of Machinery 4ed  
by Robert L. Norton  
McGraw-Hill  
Copyright 2008

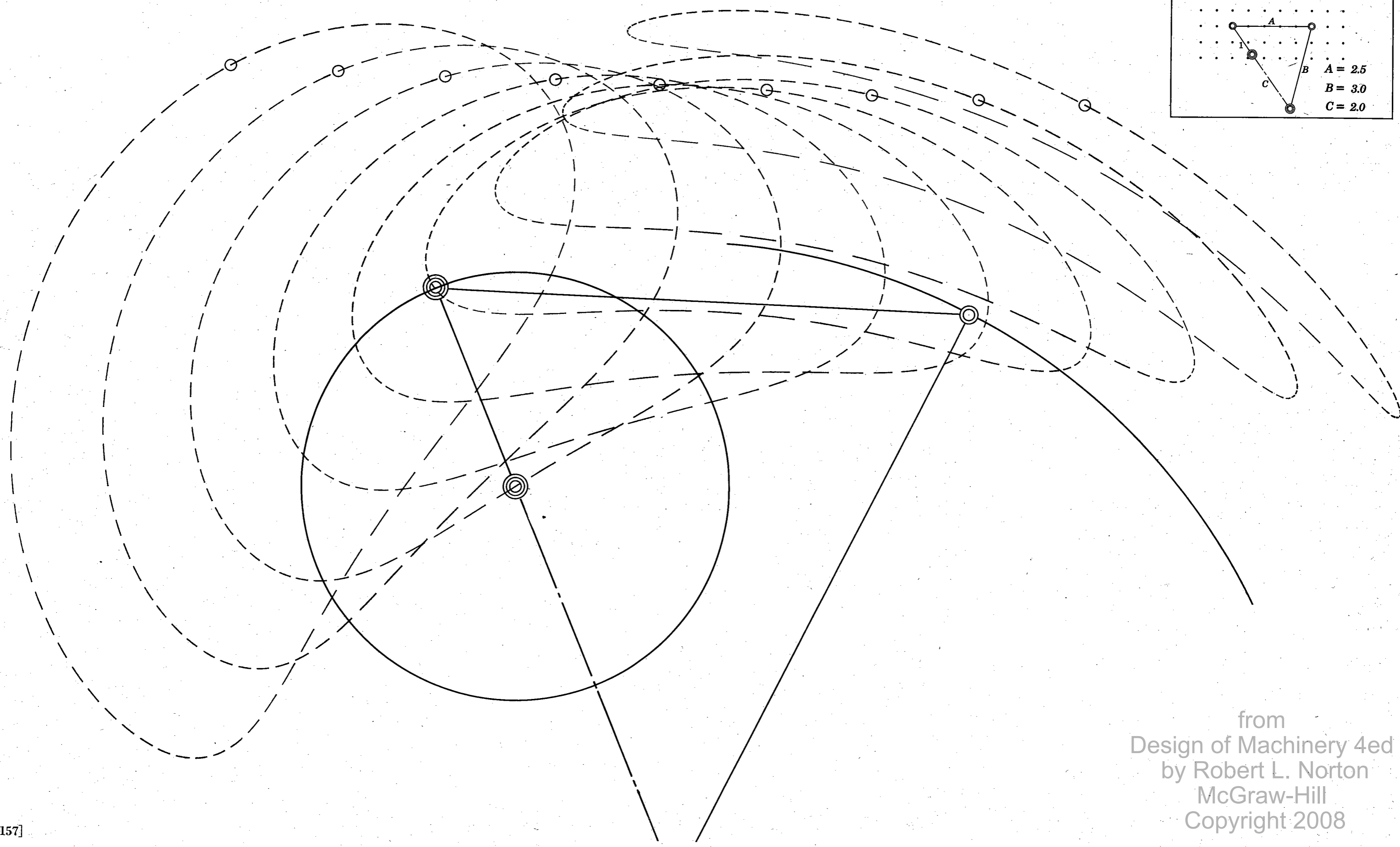
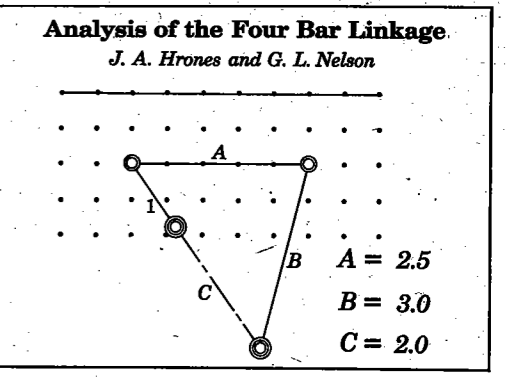

from  
 Design of Machinery 4ed  
 by Robert L. Norton  
 McGraw-Hill  
 Copyright 2008

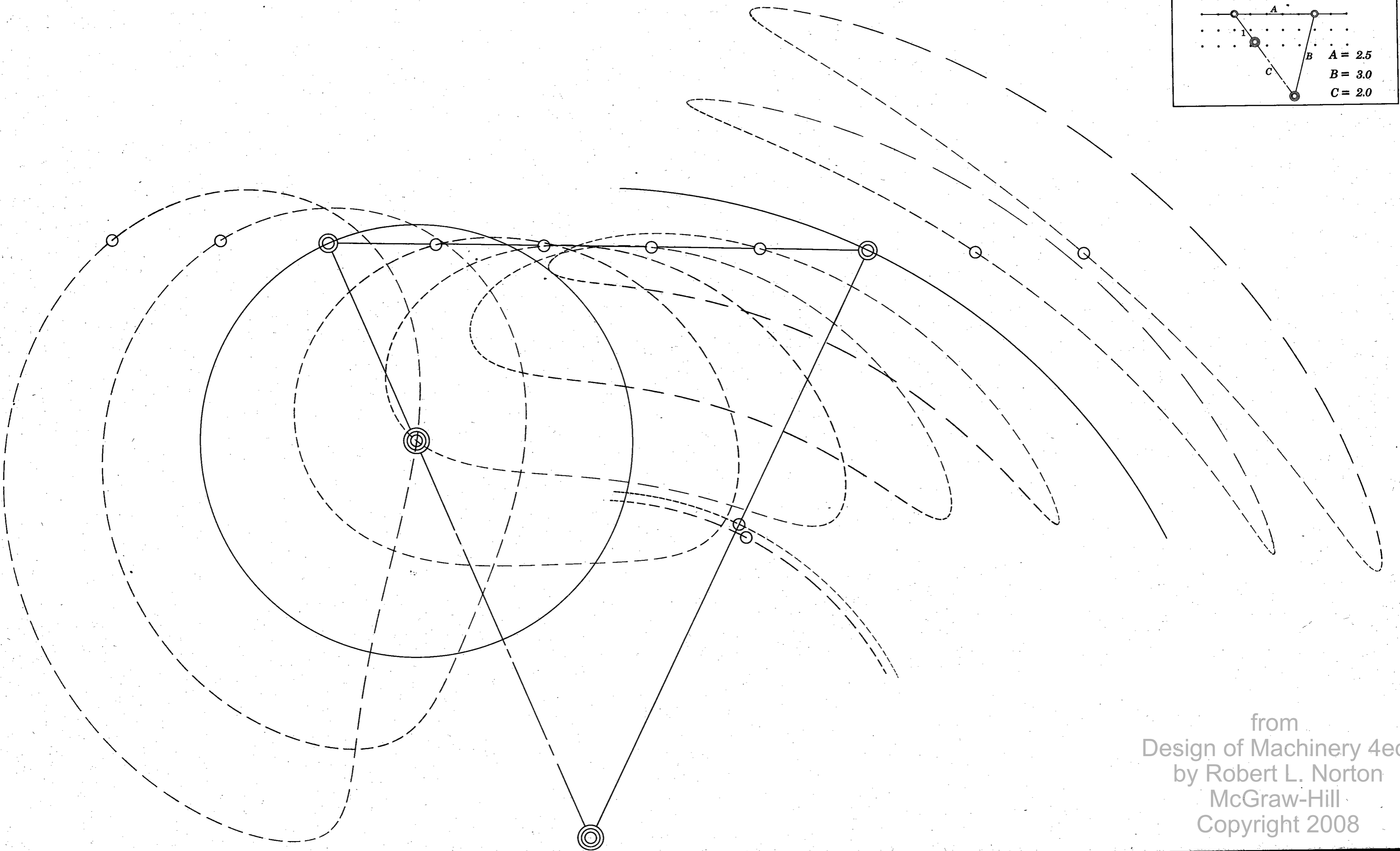
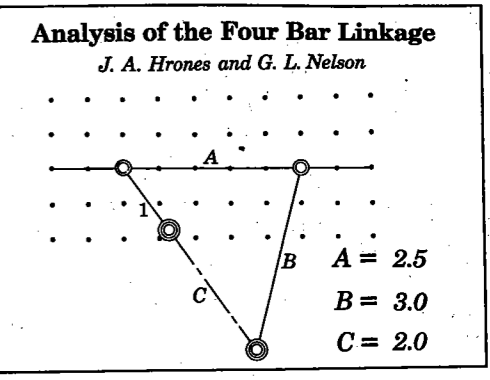

from  
Design of Machinery 4ed  
by Robert L. Norton  
McGraw-Hill  
Copyright 2008

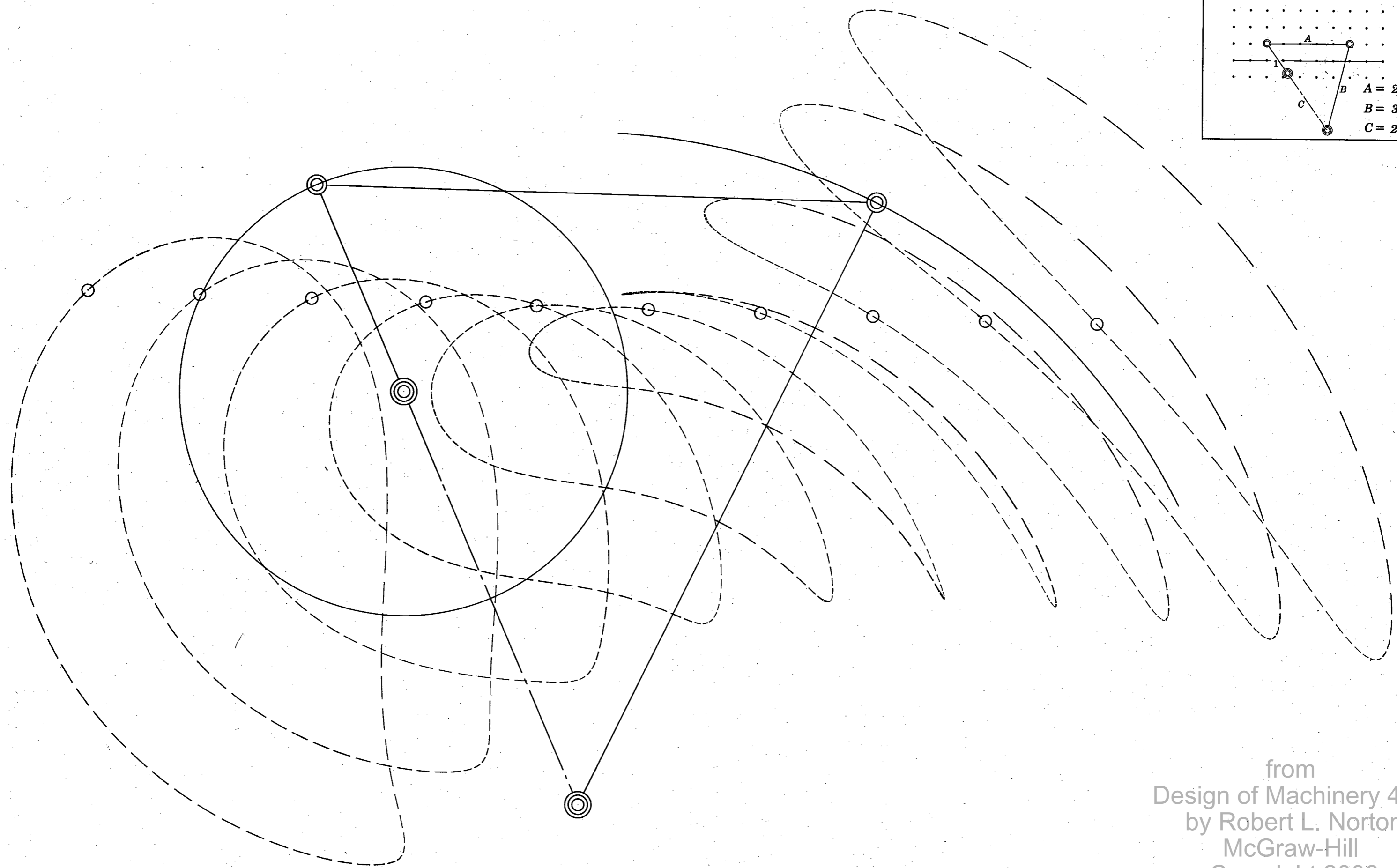
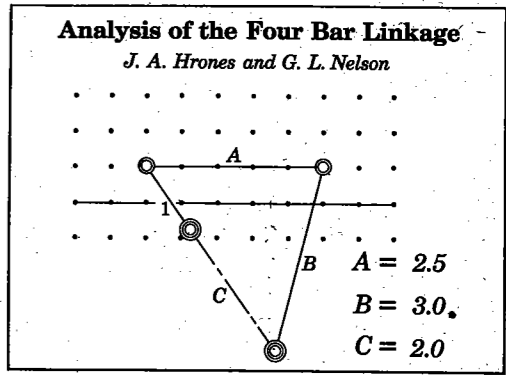

from  
 Design of Machinery 4ed  
 by Robert L. Norton  
 McGraw-Hill  
 Copyright 2008

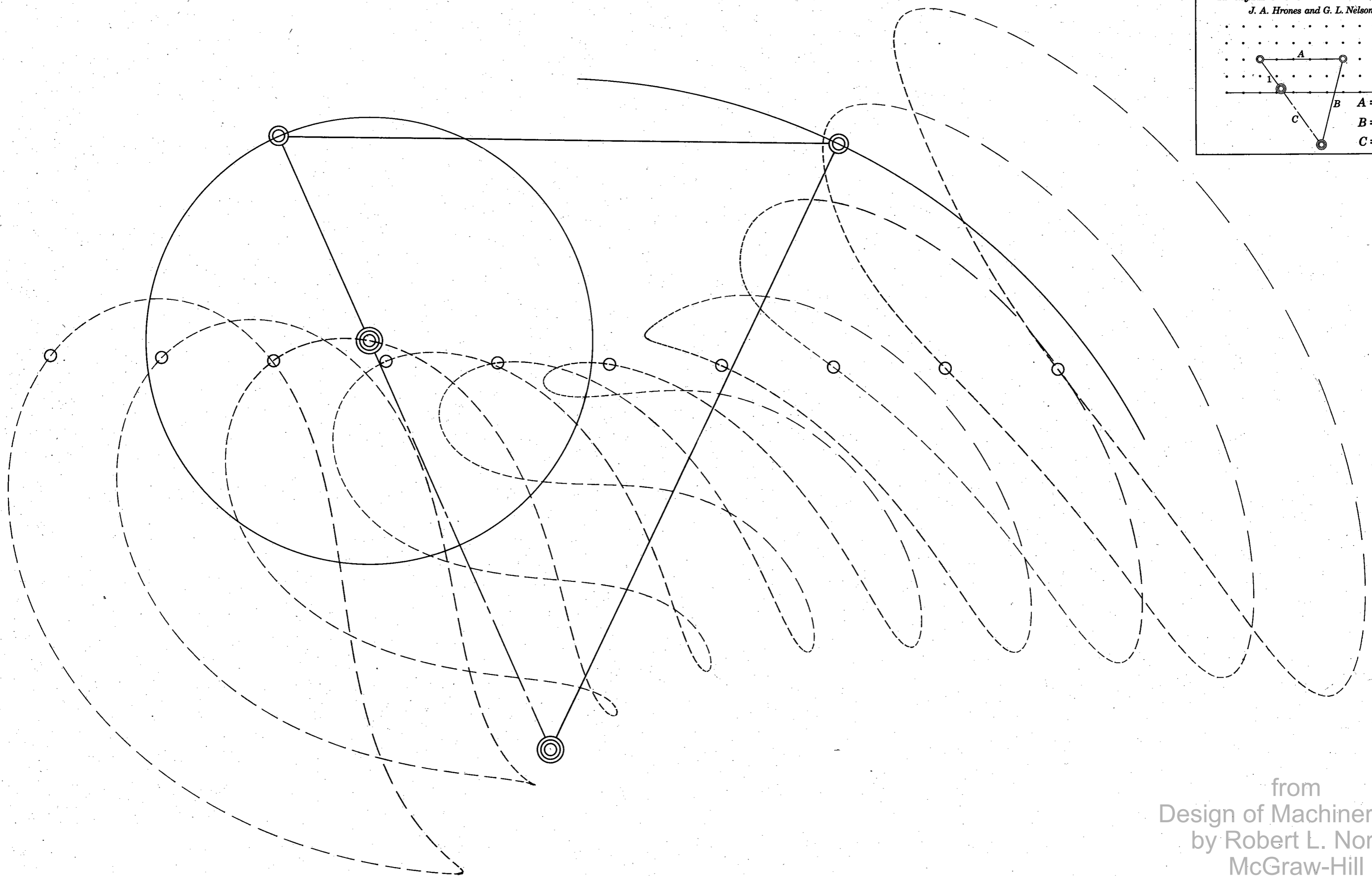
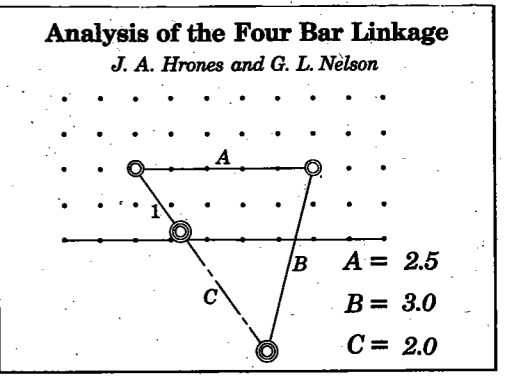

from  
Design of Machinery 4ed  
by Robert L. Norton  
McGraw-Hill  
Copyright 2008

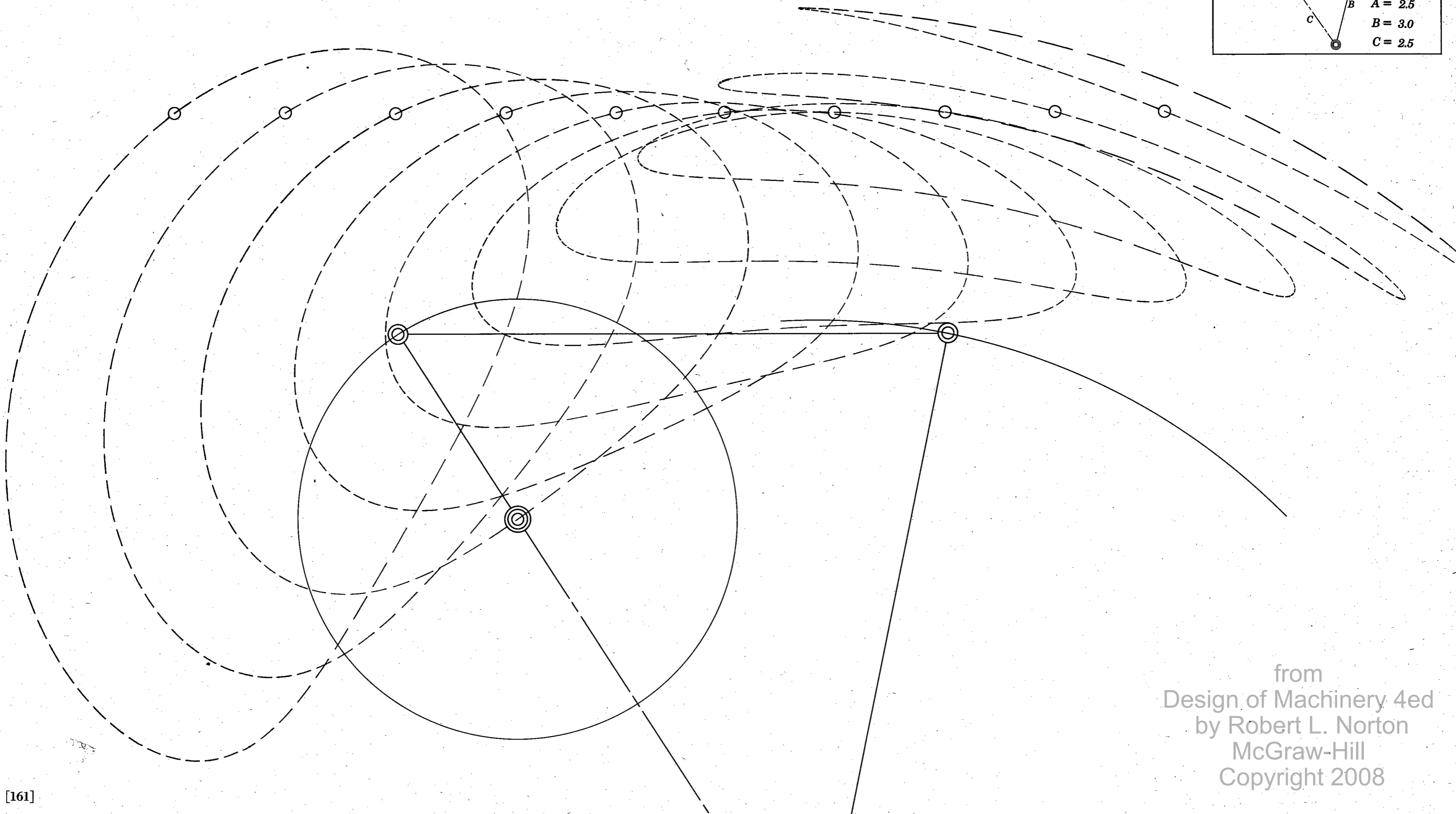
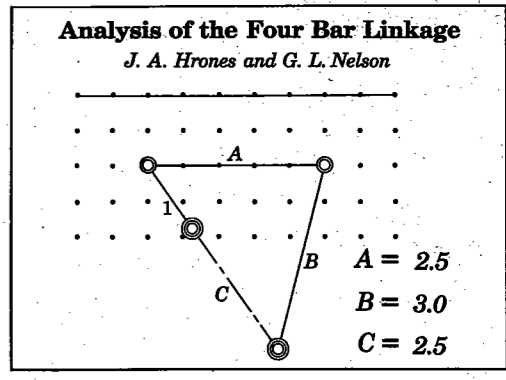

from  
 Design of Machinery 4ed  
 by Robert L. Norton  
 McGraw-Hill  
 Copyright 2008



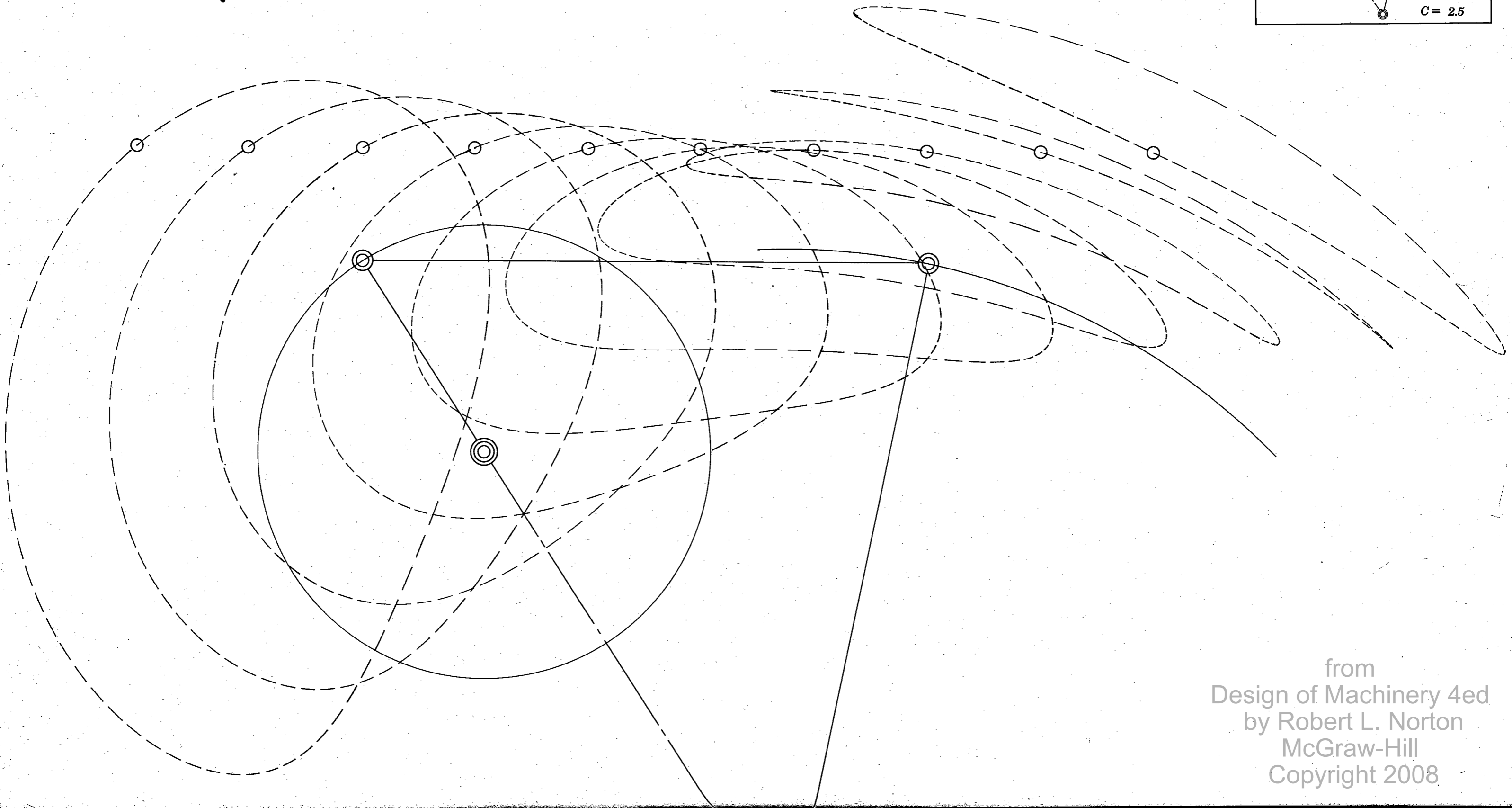
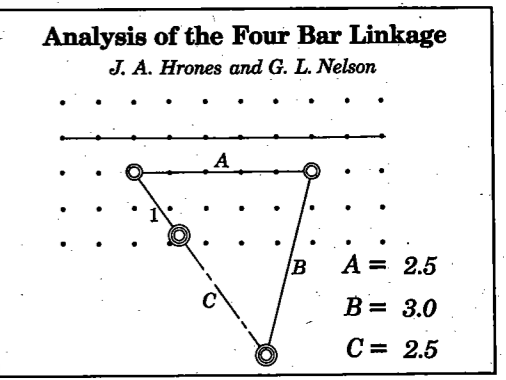

from  
Design of Machinery 4ed  
by Robert L. Norton  
McGraw-Hill  
Copyright 2008

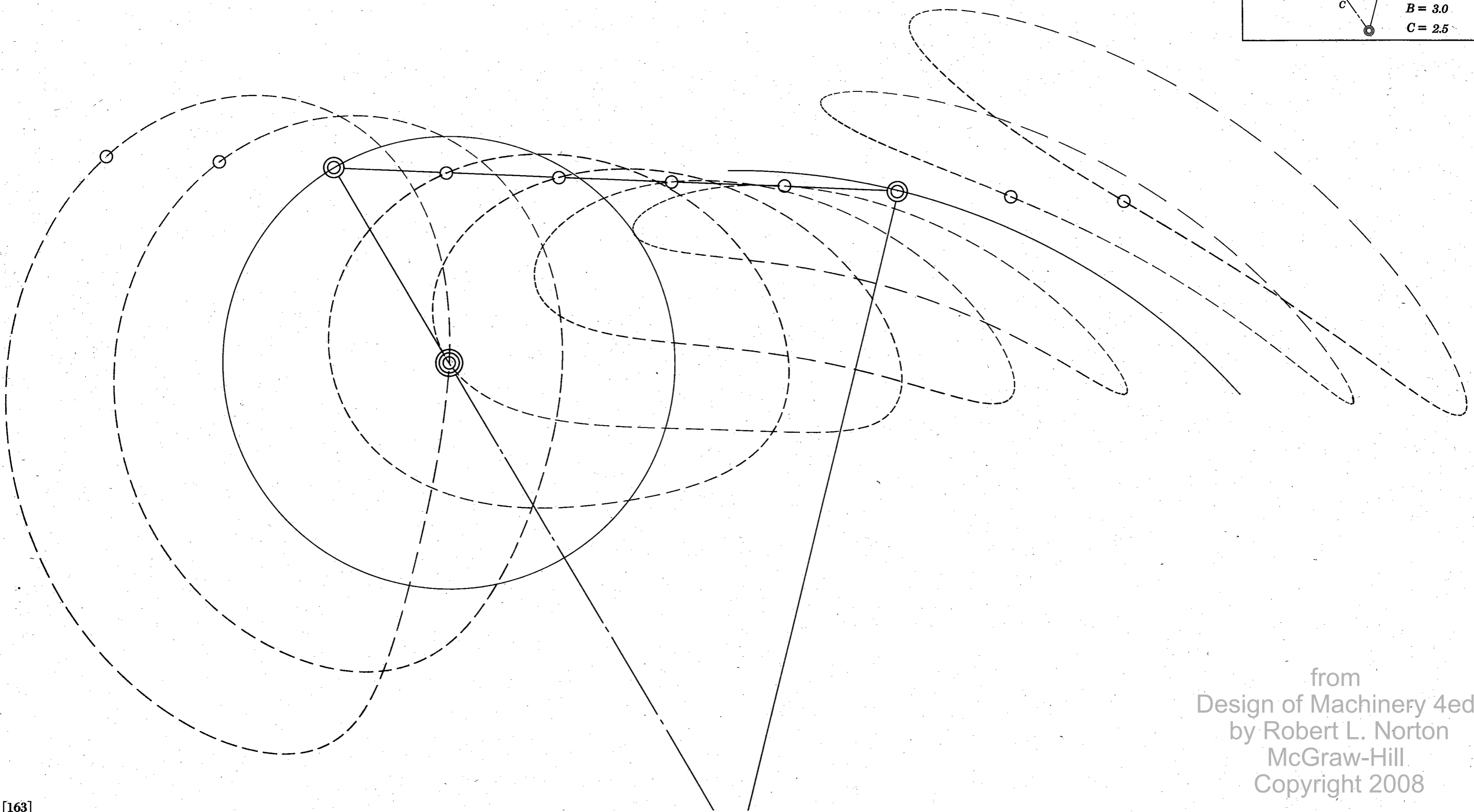
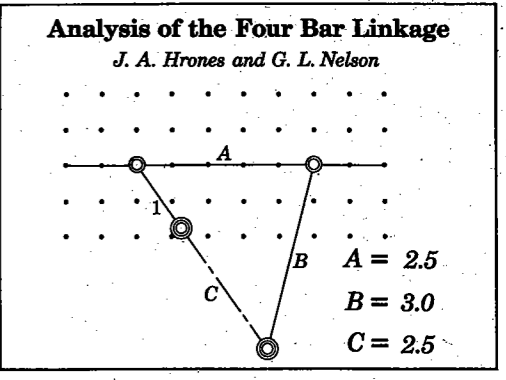

from  
 Design of Machinery 4ed  
 by Robert L. Norton  
 McGraw-Hill  
 Copyright 2008

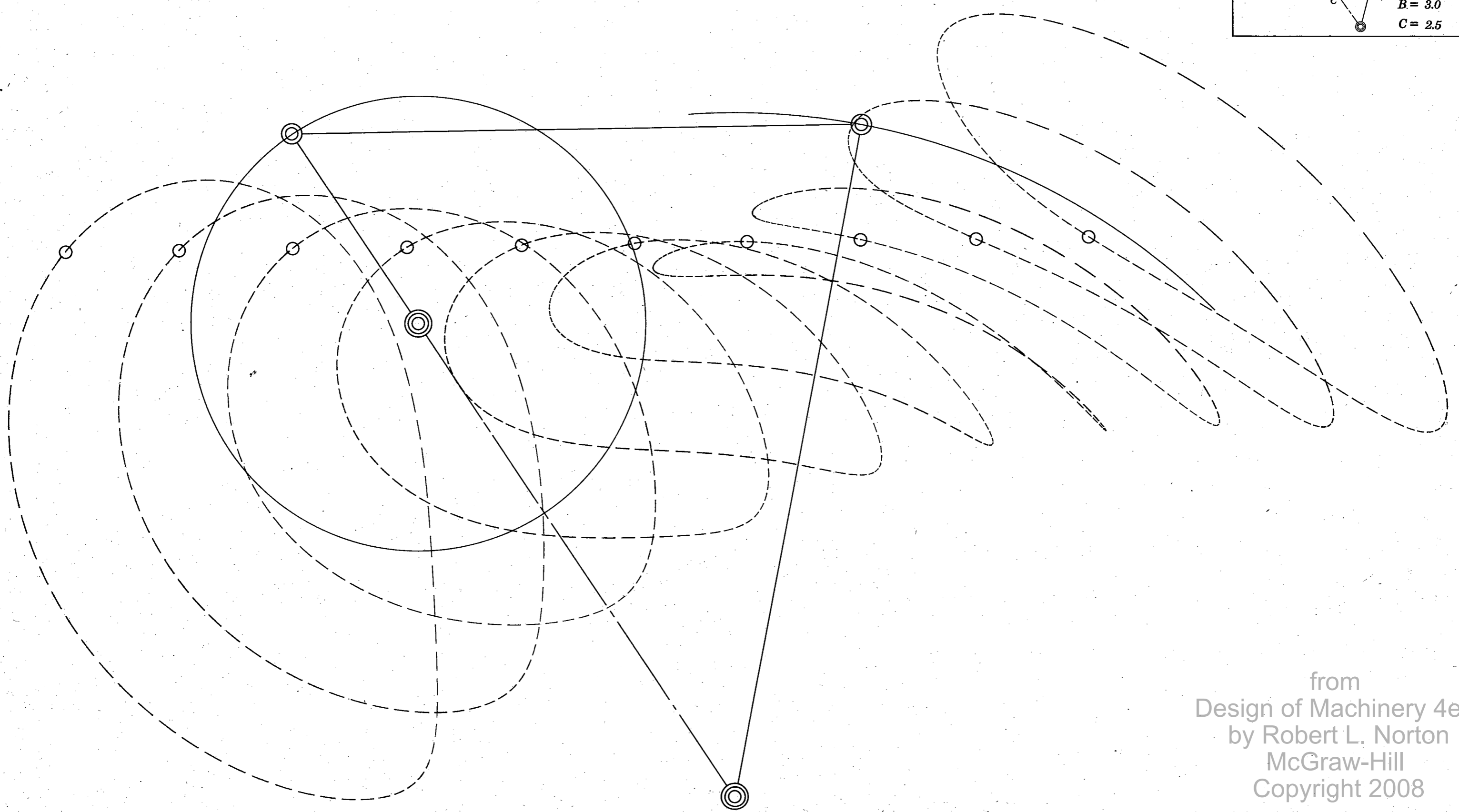
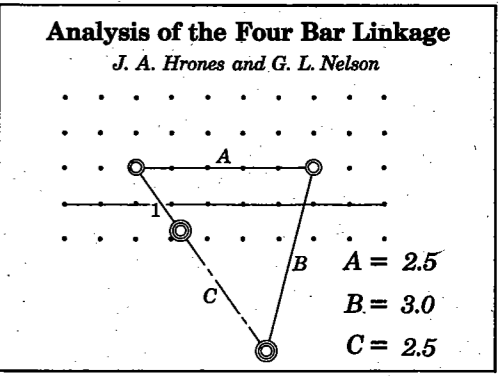

from  
Design of Machinery 4ed  
by Robert L. Norton  
McGraw-Hill  
Copyright 2008

**Analysis of the Four Bar Linkage**

*J. A. Hrones and G. L. Nelson*

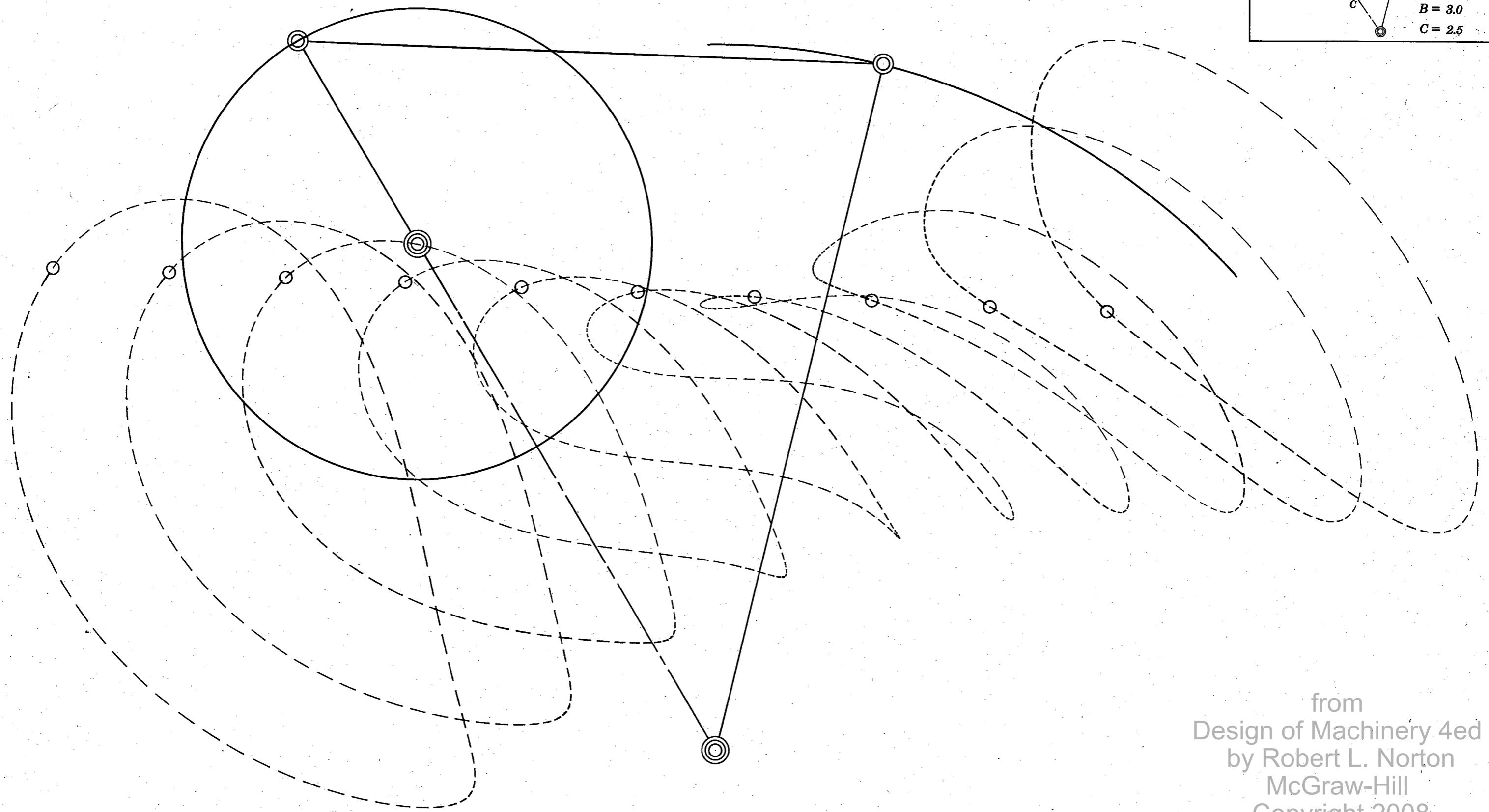
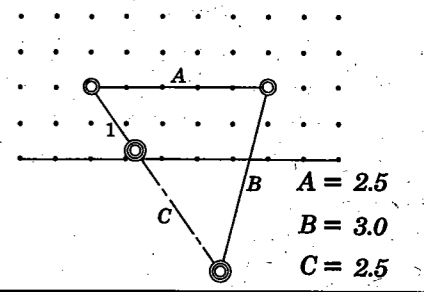

from  
Design of Machinery 4ed  
by Robert L. Norton  
McGraw-Hill  
Copyright 2008

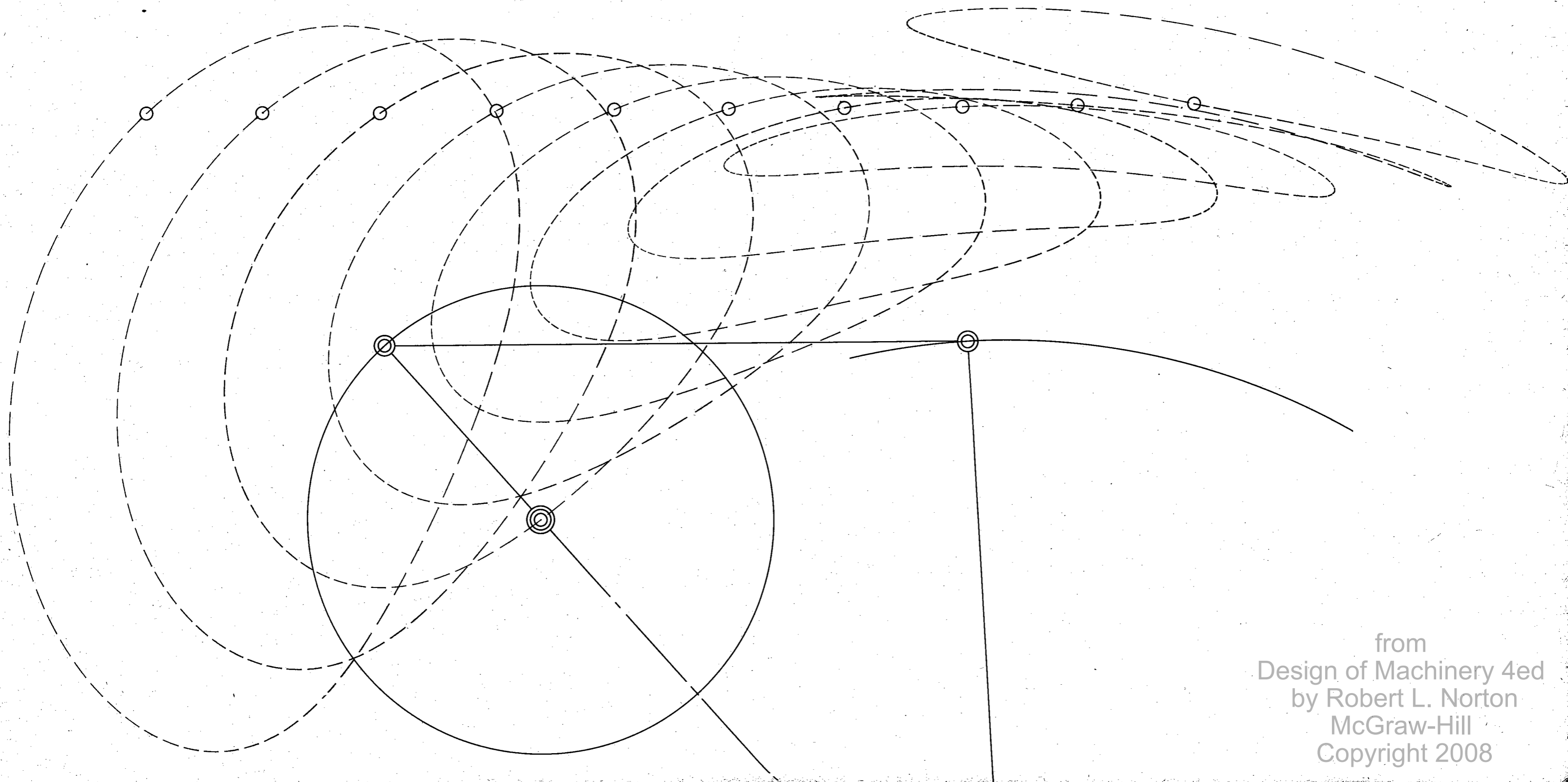
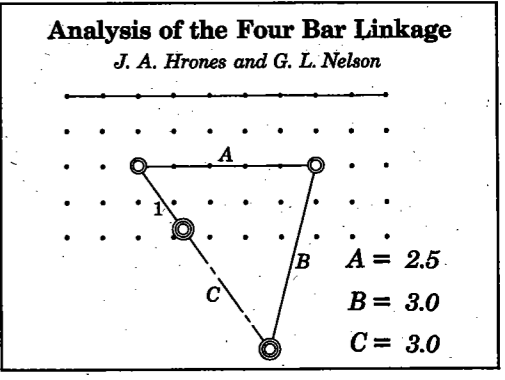

from  
Design of Machinery 4ed  
by Robert L. Norton  
McGraw-Hill  
Copyright 2008

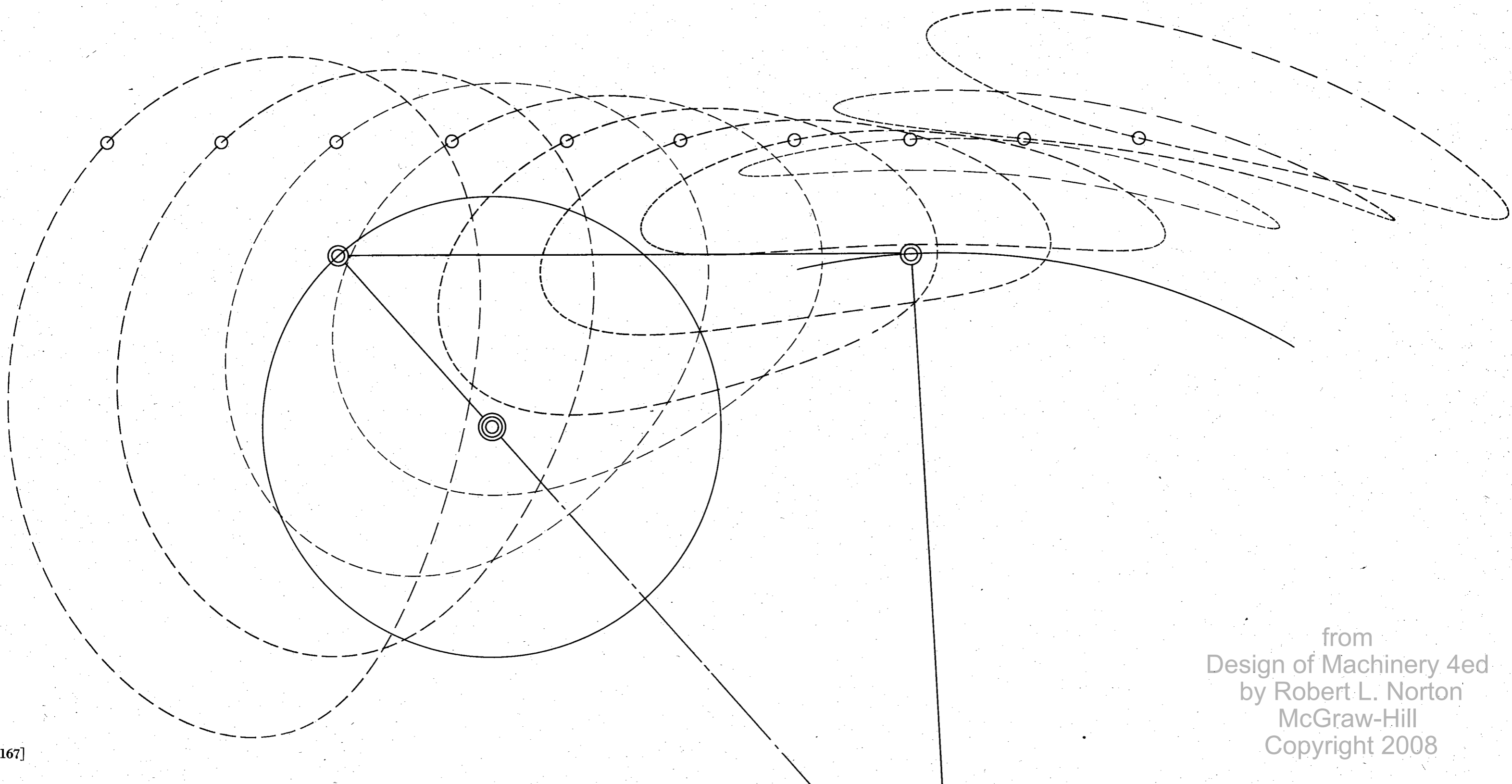
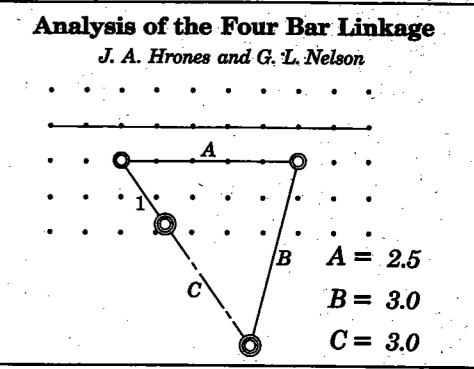

from  
 Design of Machinery 4ed  
 by Robert L. Norton  
 McGraw-Hill  
 Copyright 2008

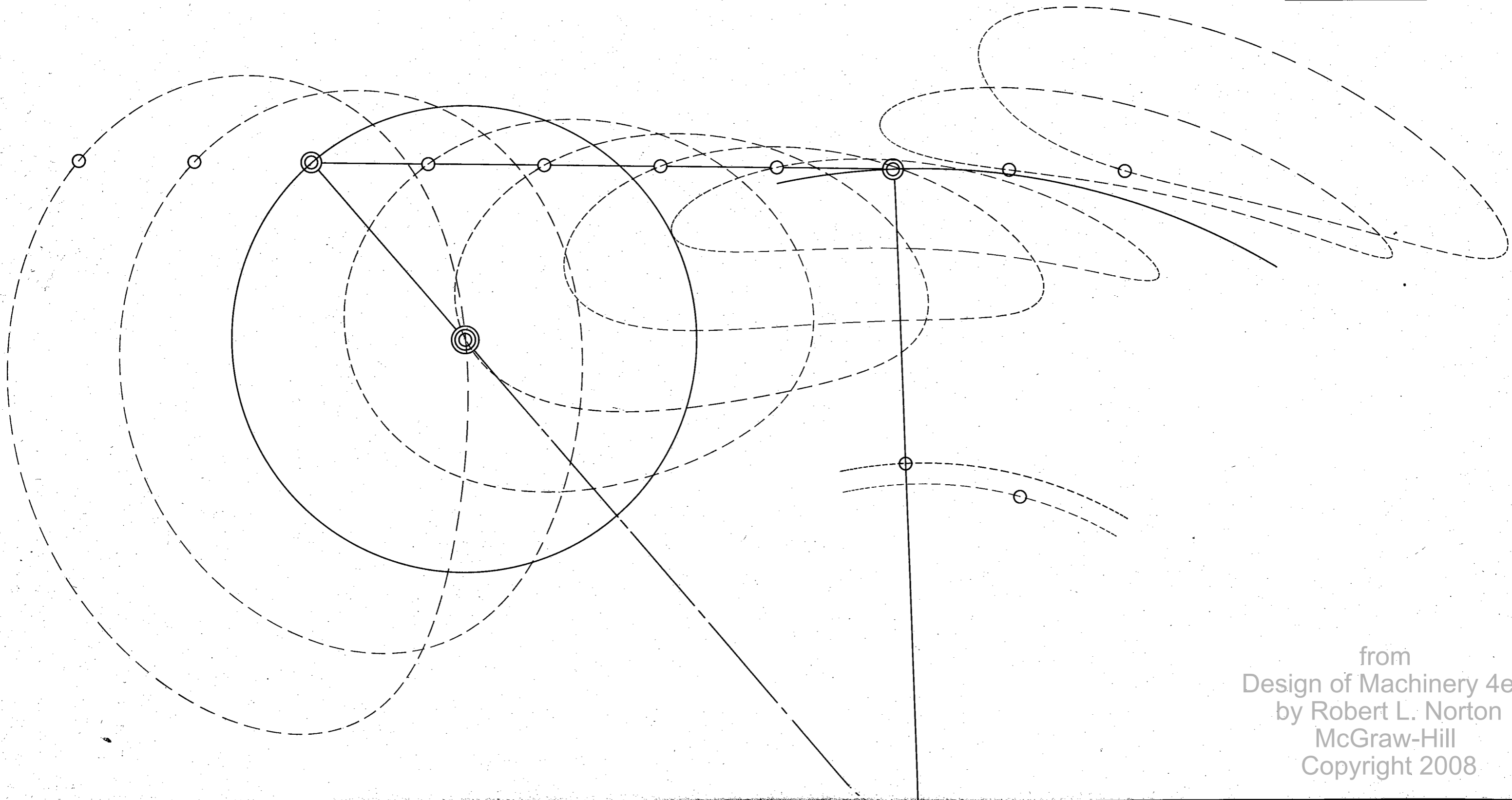
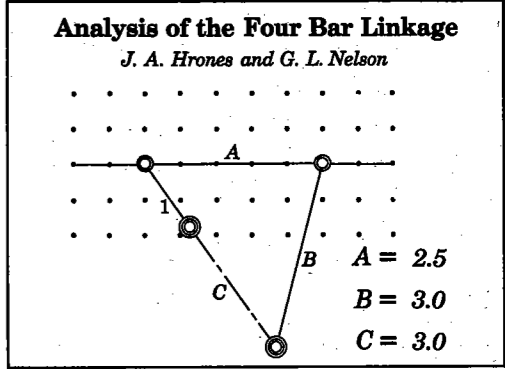

from  
Design of Machinery 4ed  
by Robert L. Norton  
McGraw-Hill  
Copyright 2008

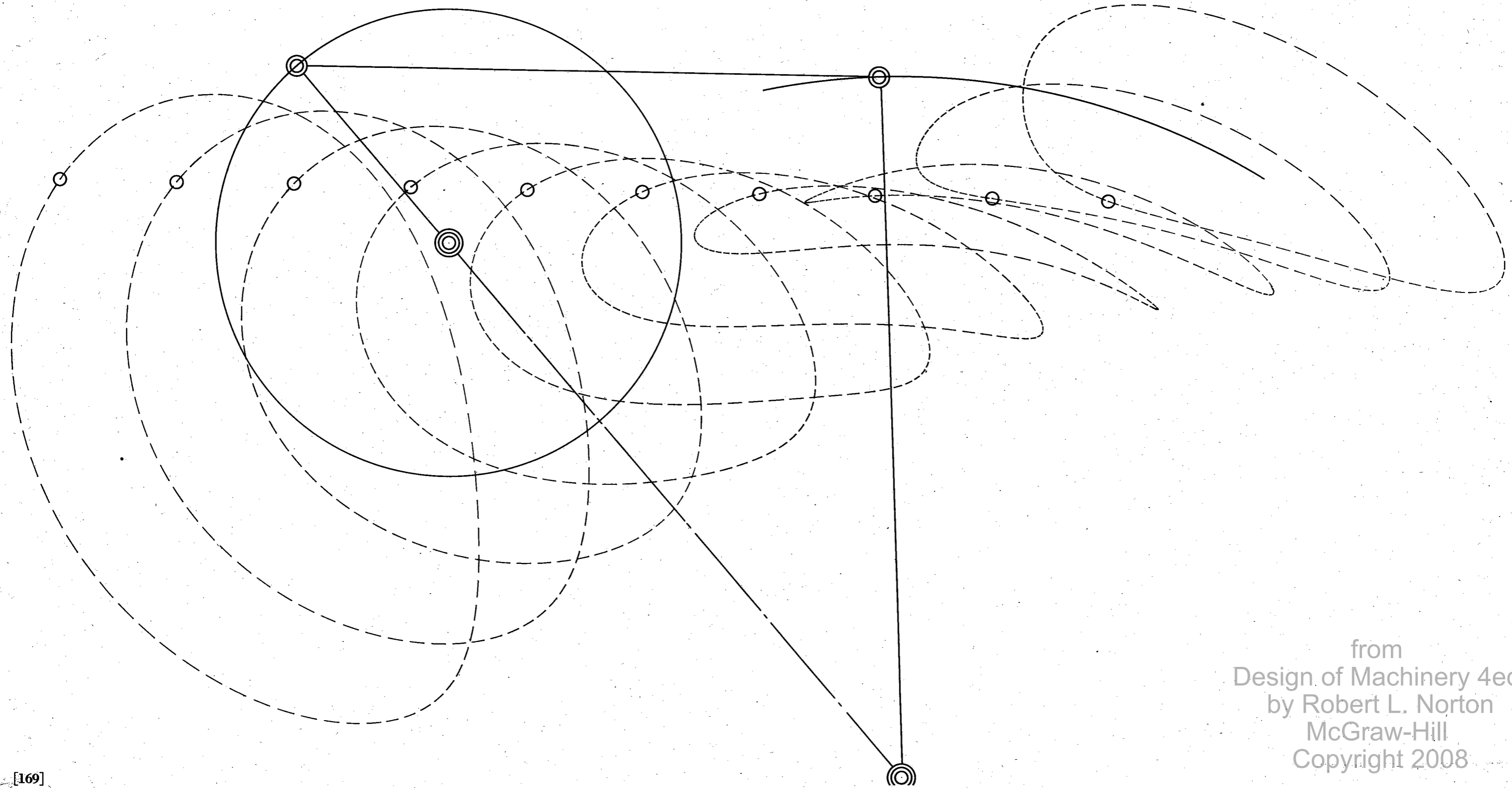
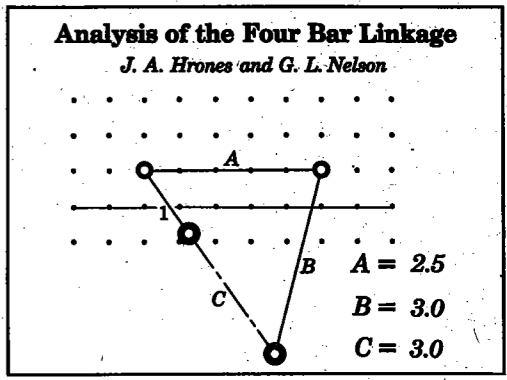

from  
 Design of Machinery 4ed  
 by Robert L. Norton  
 McGraw-Hill  
 Copyright 2008



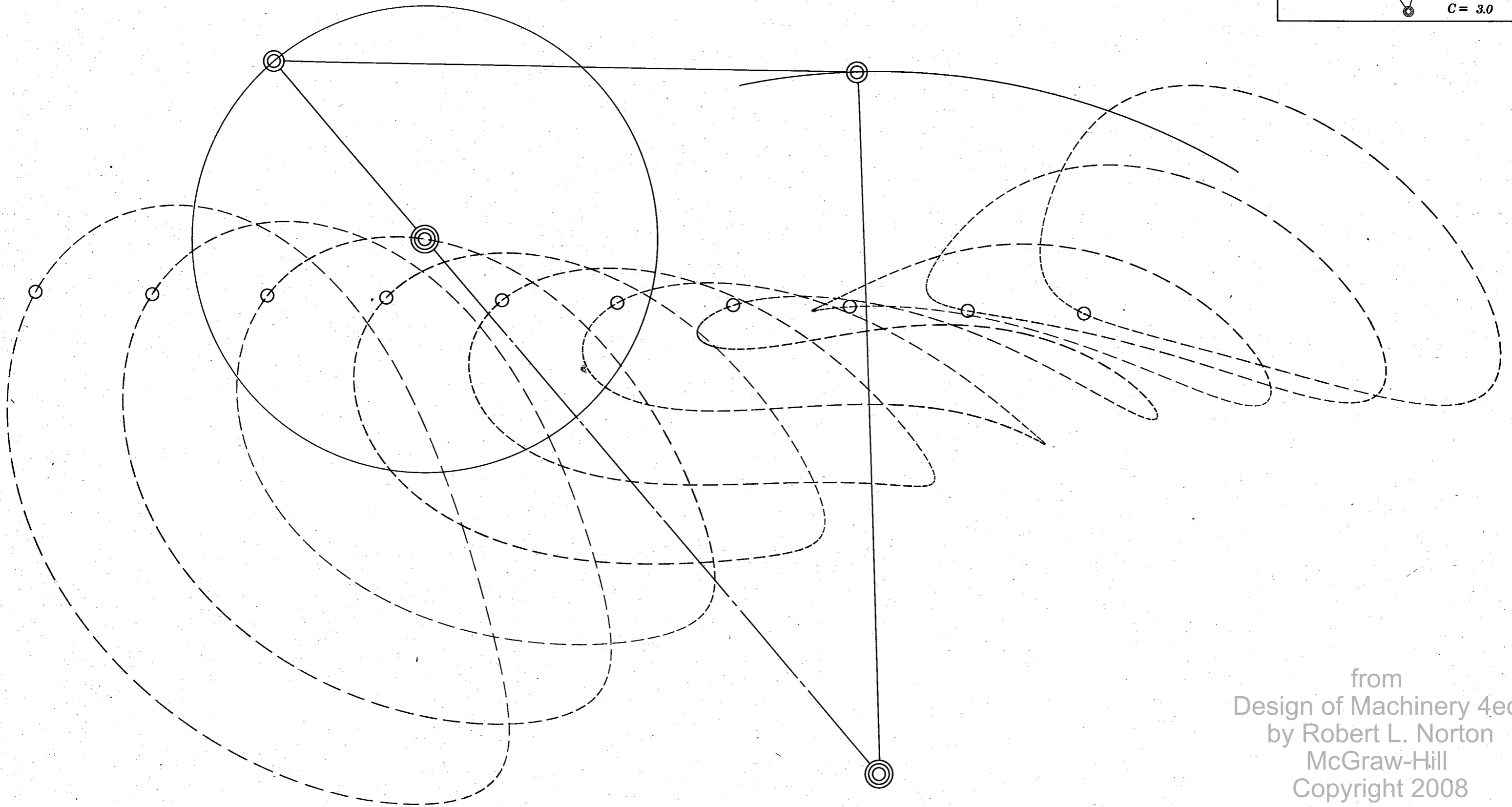
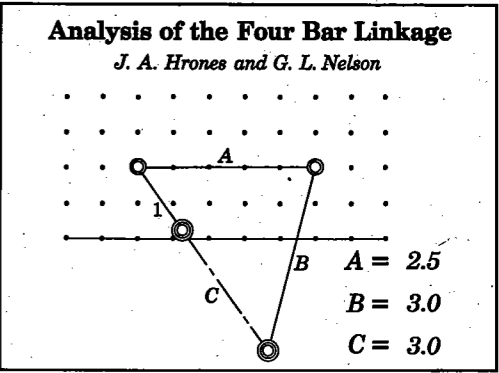

from  
Design of Machinery 4ed  
by Robert L. Norton  
McGraw-Hill  
Copyright 2008

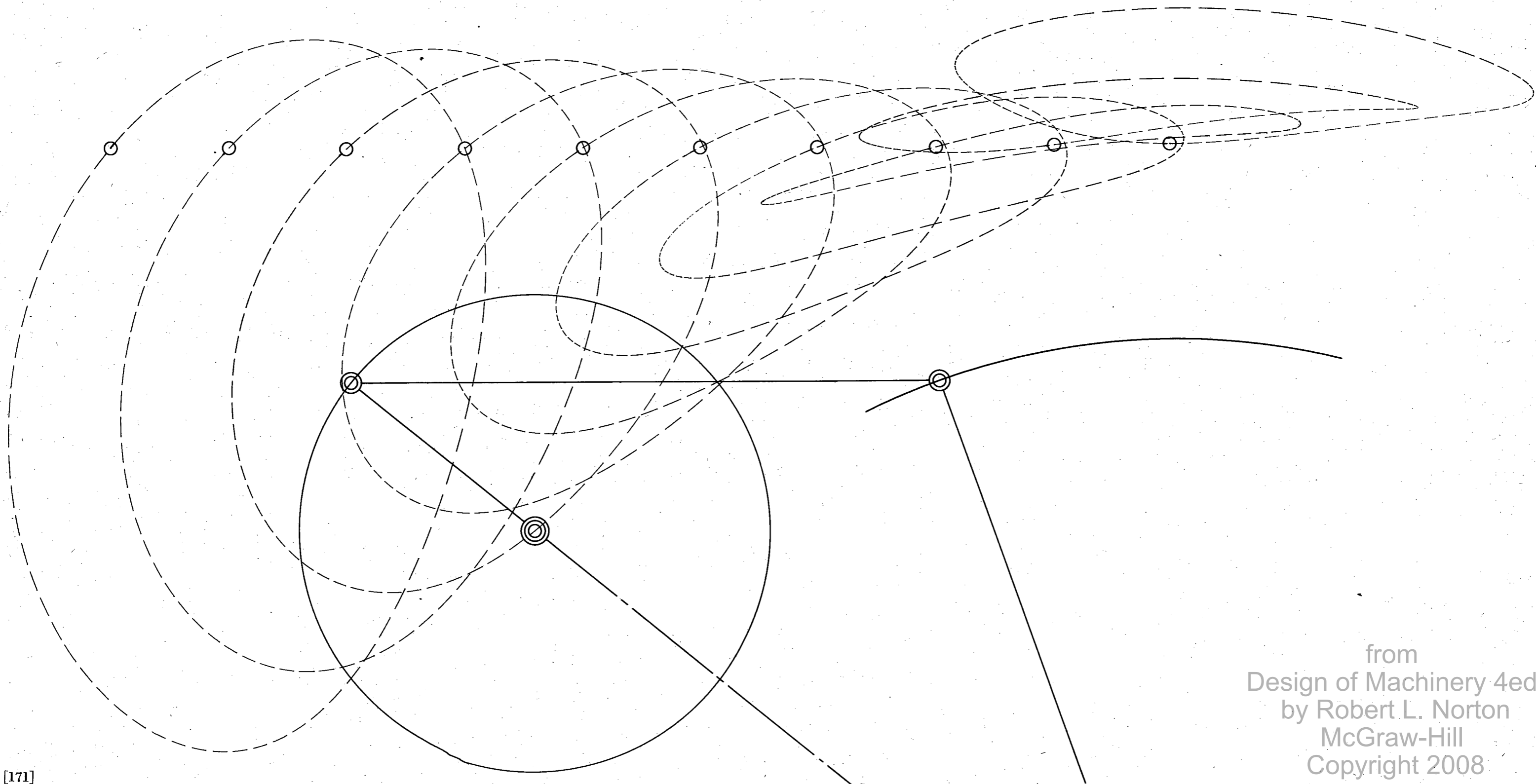
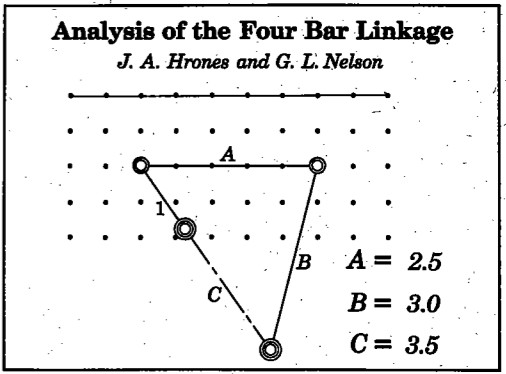

from  
 Design of Machinery 4ed  
 by Robert L. Norton  
 McGraw-Hill  
 Copyright 2008

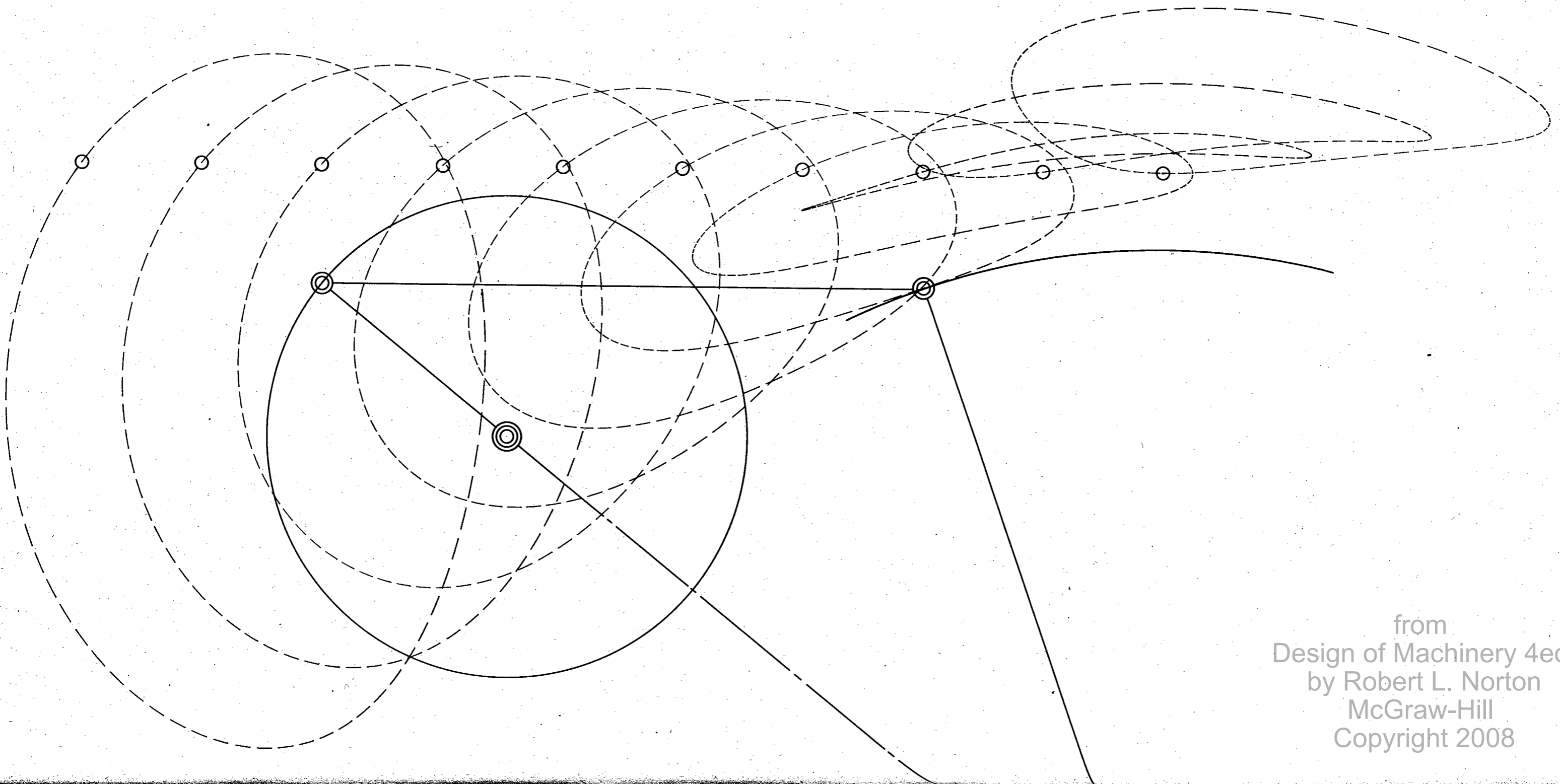
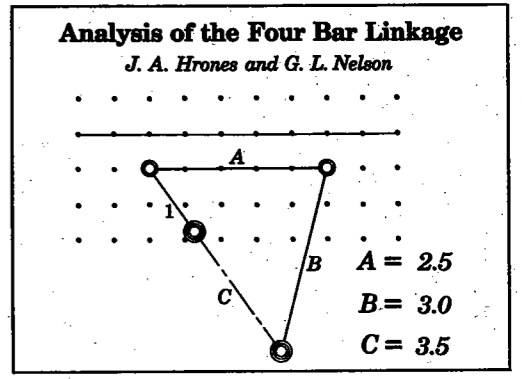

from  
Design of Machinery 4ed  
by Robert L. Norton  
McGraw-Hill  
Copyright 2008

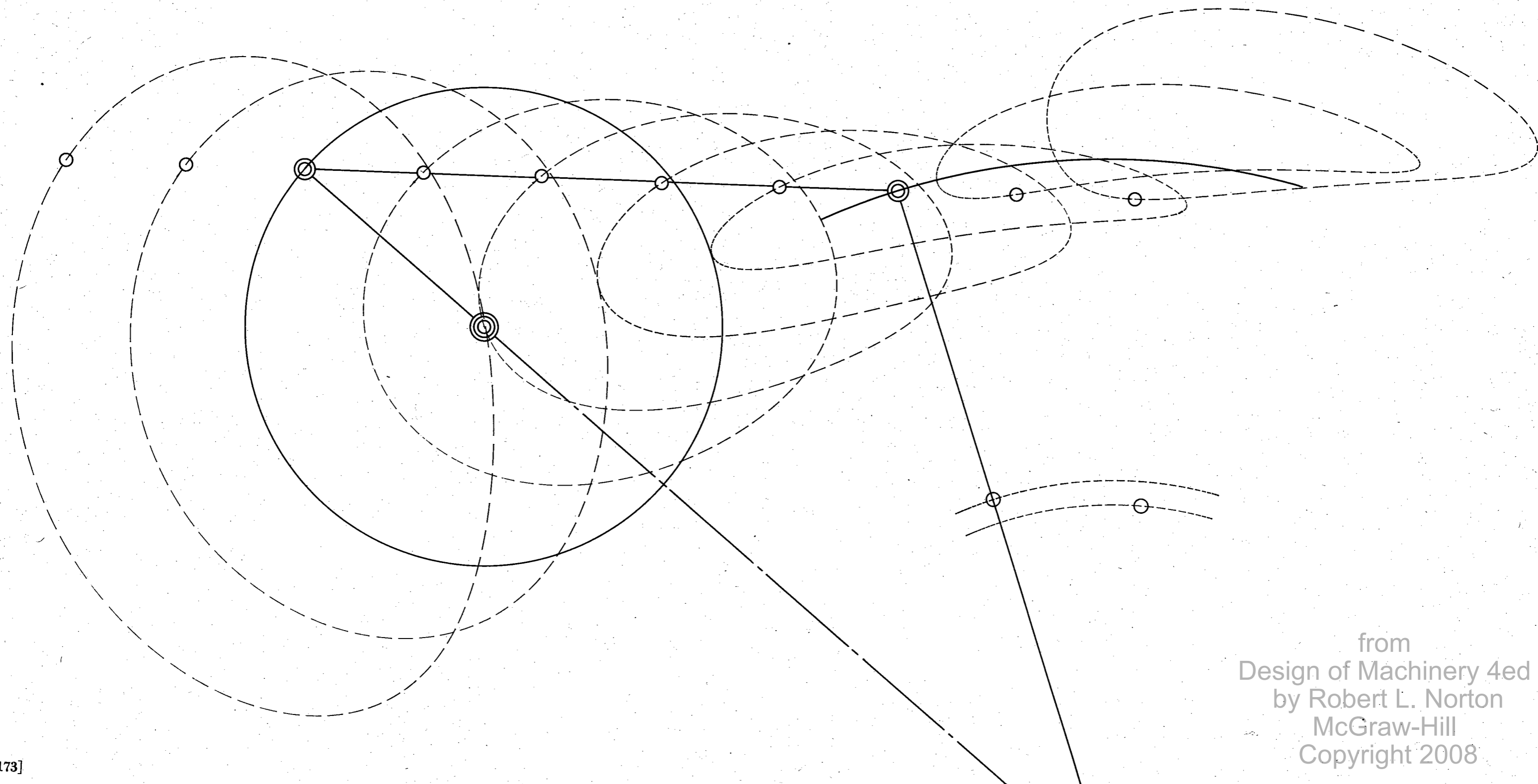
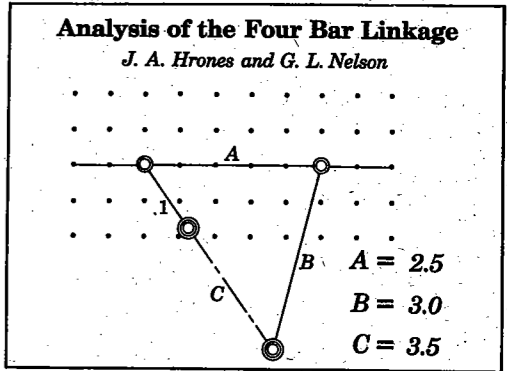

from  
 Design of Machinery 4ed  
 by Robert L. Norton  
 McGraw-Hill  
 Copyright 2008

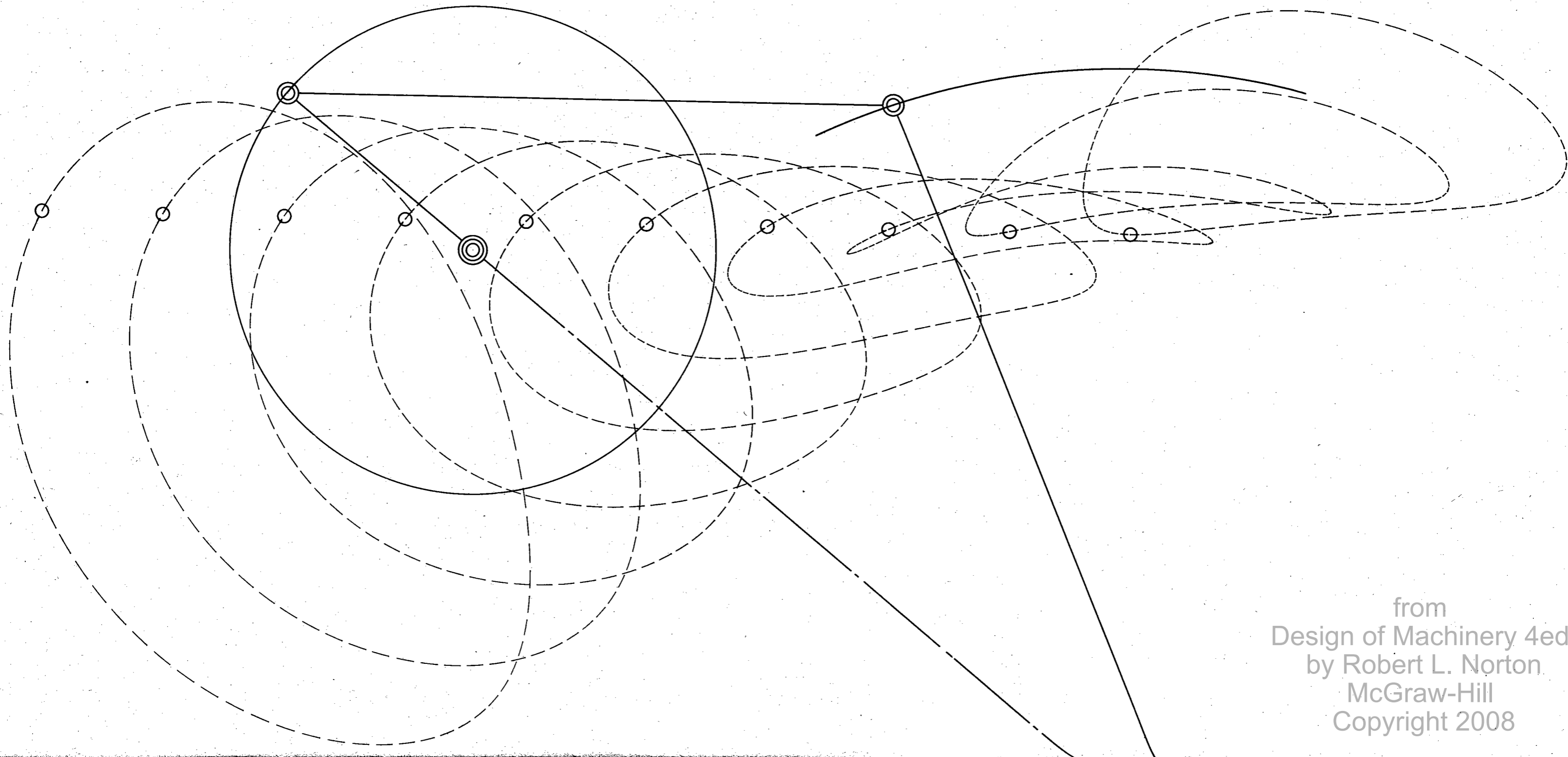
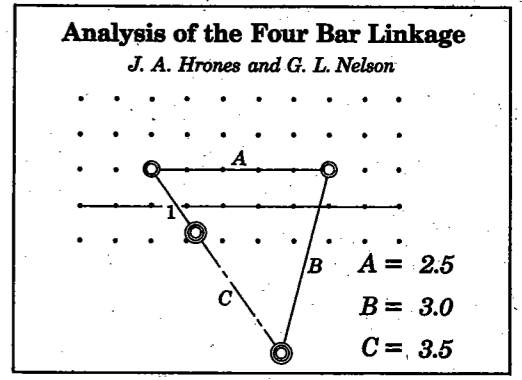

from  
Design of Machinery 4ed  
by Robert L. Norton  
McGraw-Hill  
Copyright 2008

**Analysis of the Four Bar Linkage**

*J. A. Hrones and G. L. Nelson*

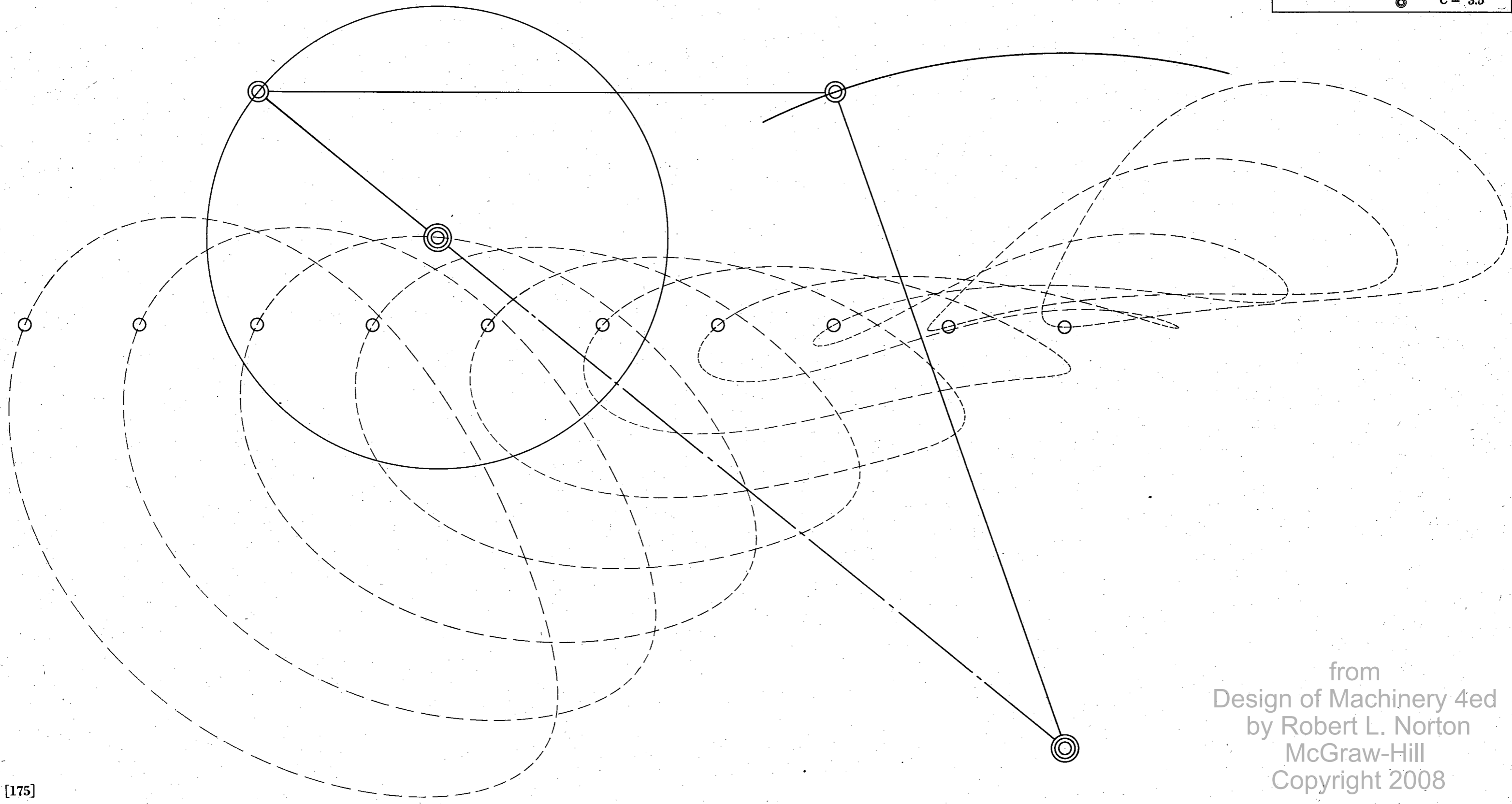
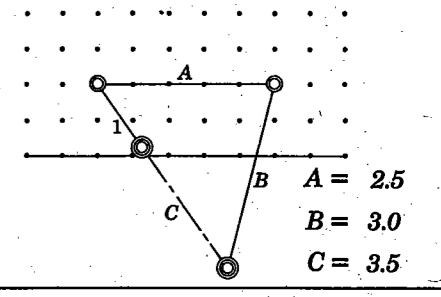

from  
Design of Machinery 4ed  
by Robert L. Norton  
McGraw-Hill  
Copyright 2008

**Analysis of the Four Bar Linkage**  
*J. A. Hrones and G. L. Nelson*

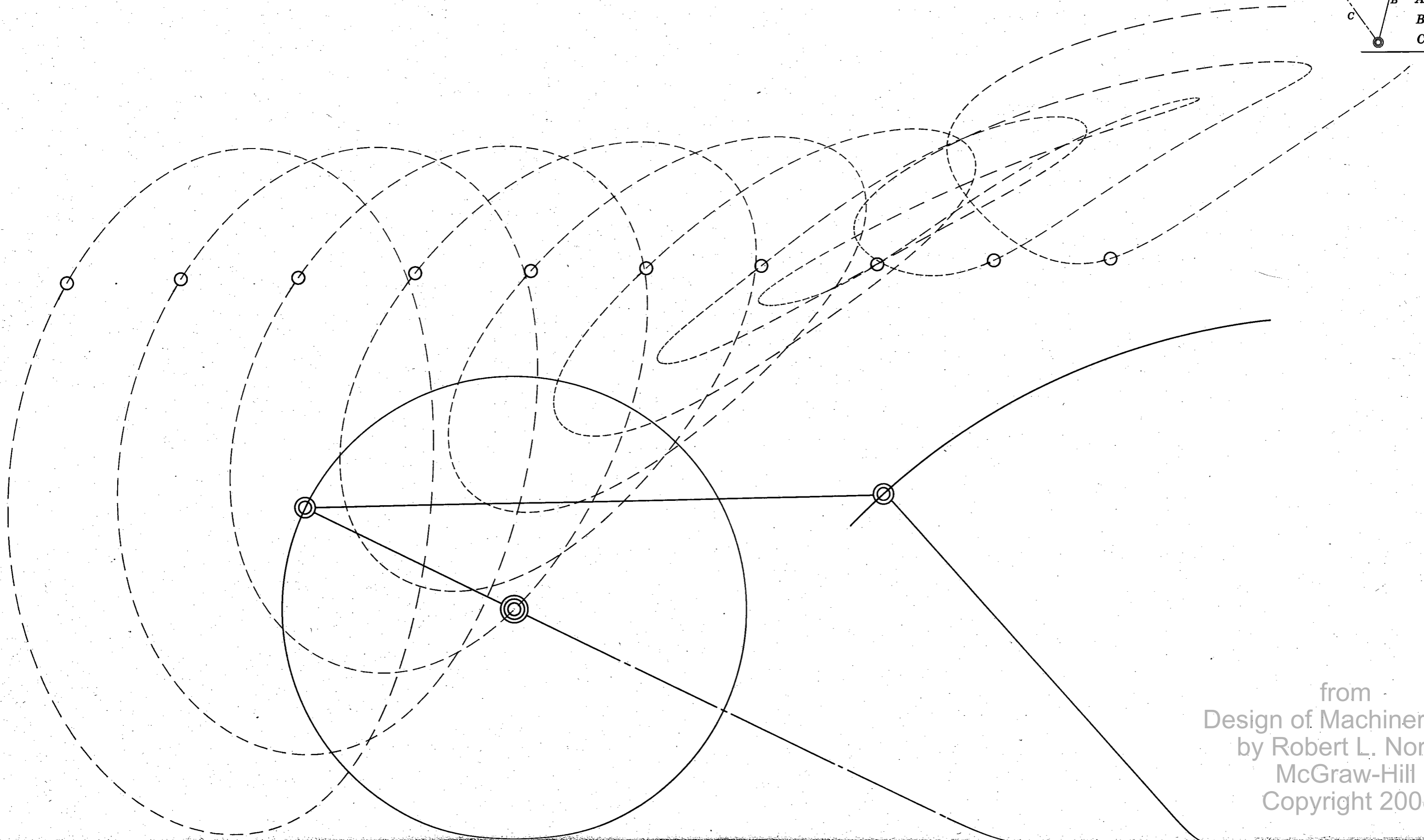
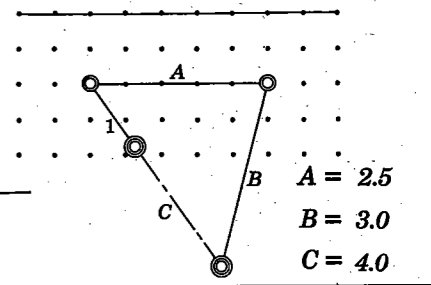

from  
Design of Machinery 4ed  
by Robert L. Norton  
McGraw-Hill  
Copyright 2008

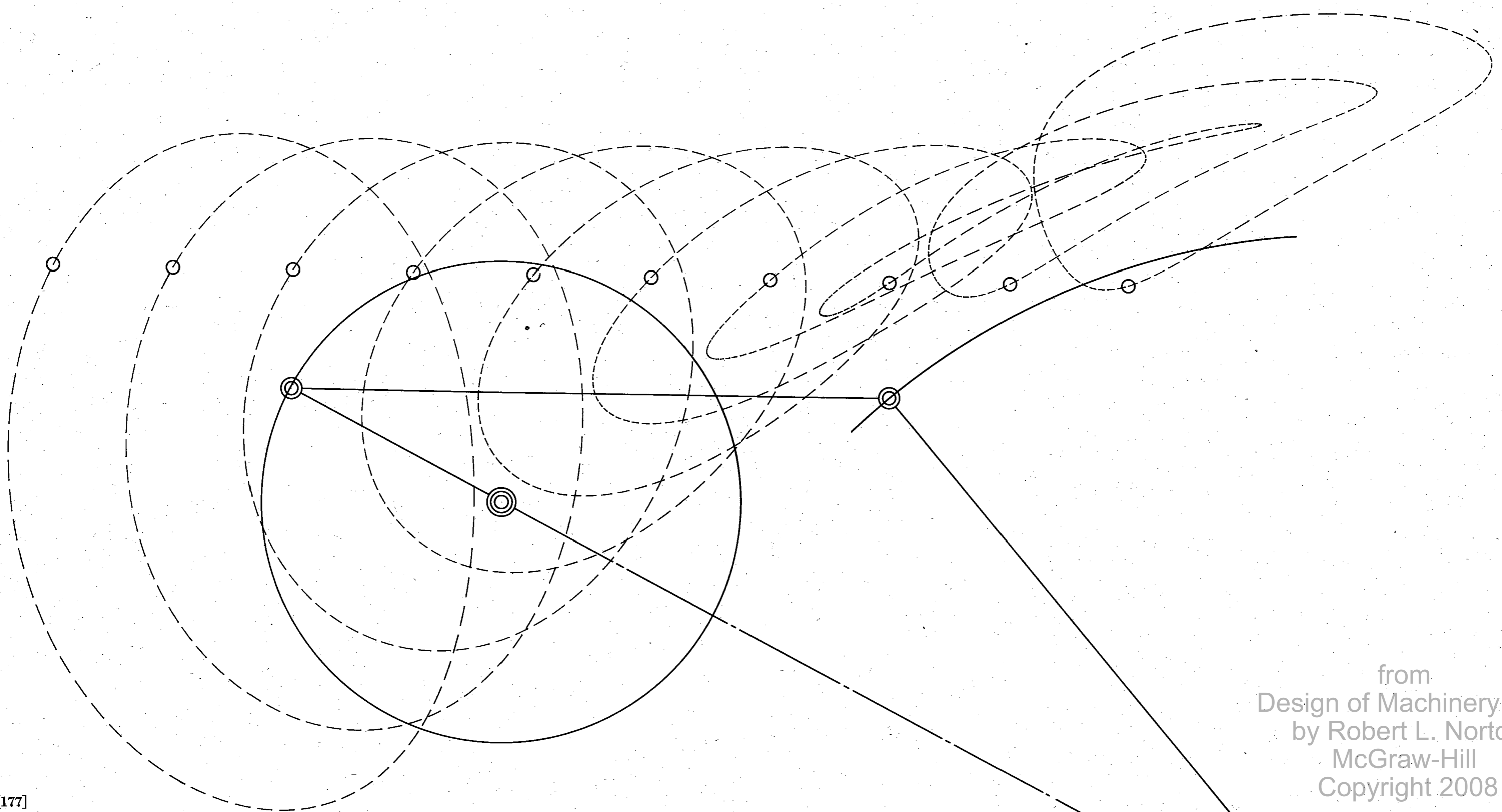
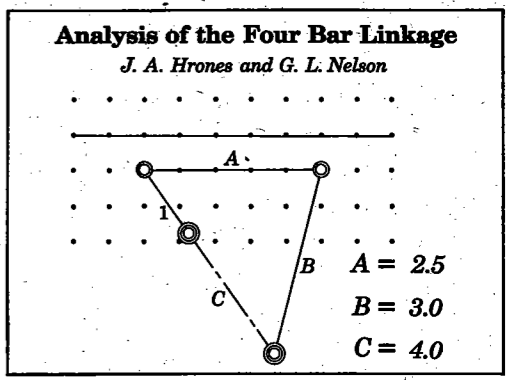

from  
 Design of Machinery 4ed  
 by Robert L. Norton  
 McGraw-Hill  
 Copyright 2008



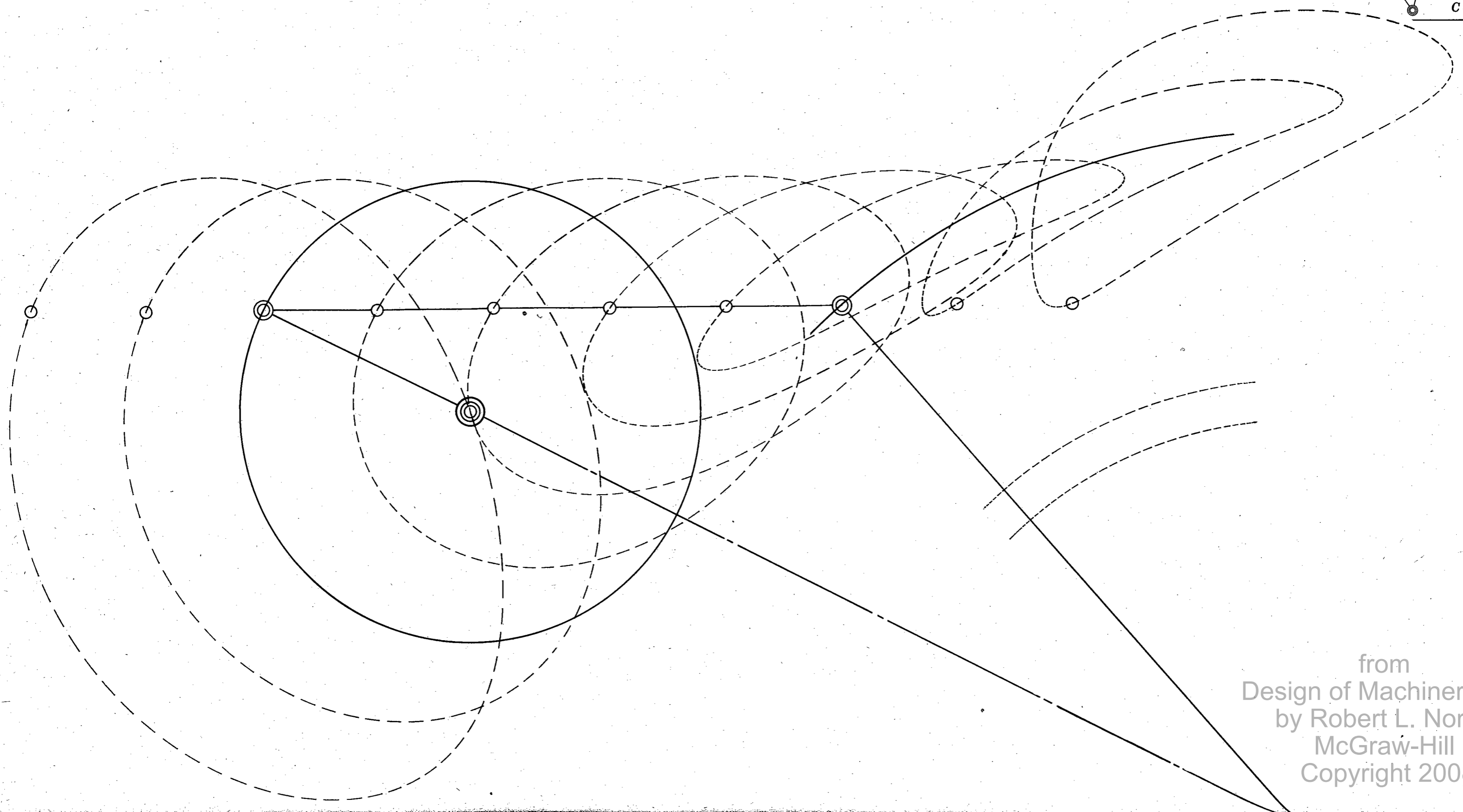
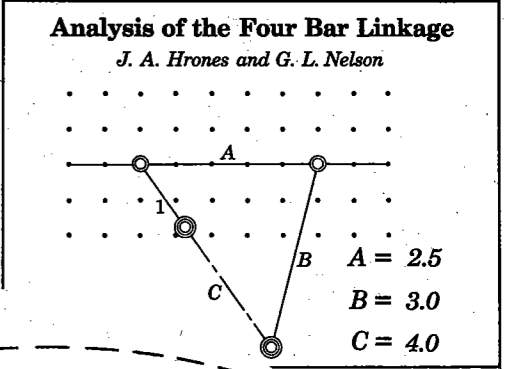

from  
Design of Machinery 4ed  
by Robert L. Norton  
McGraw-Hill  
Copyright 2008

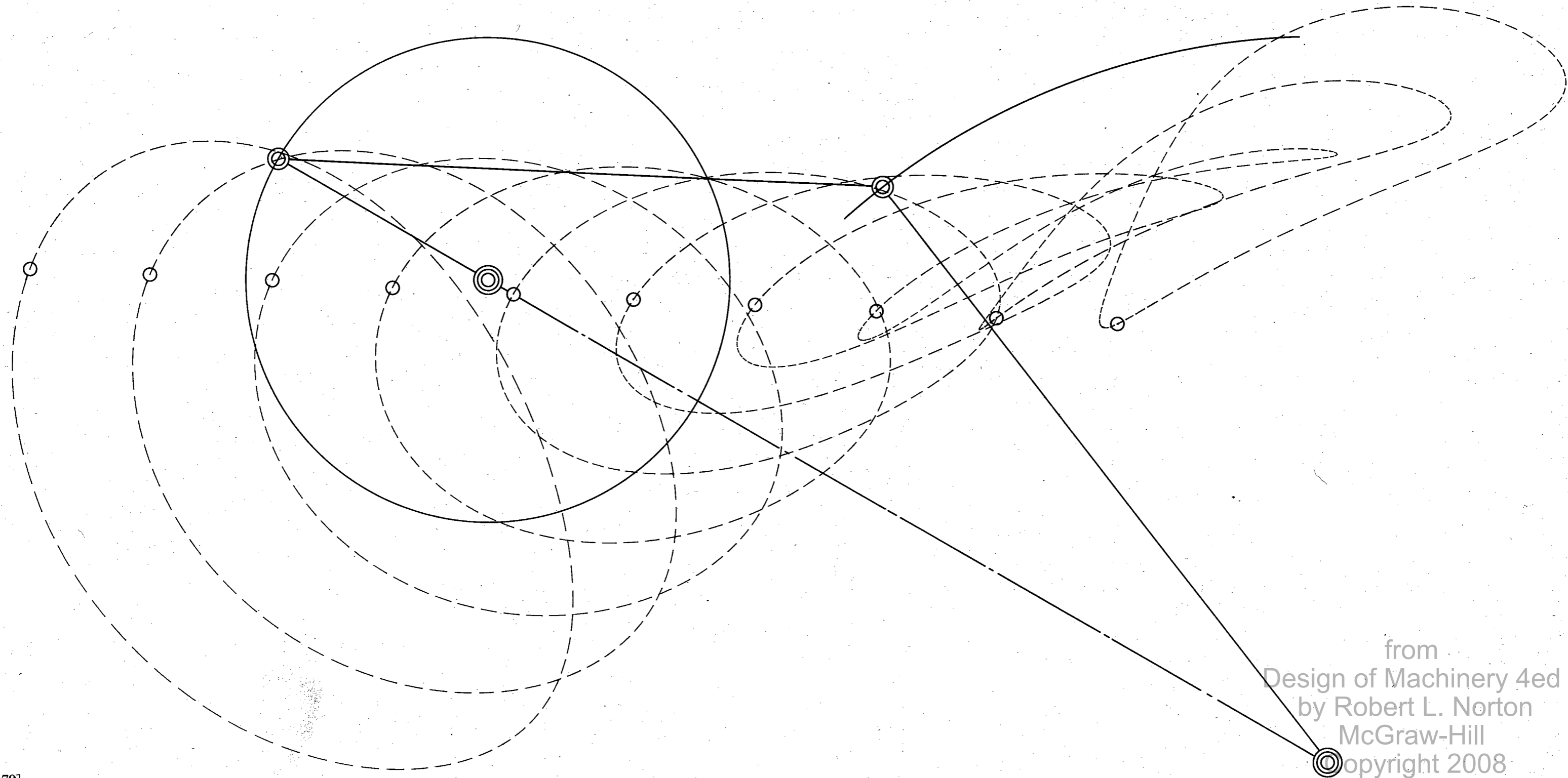
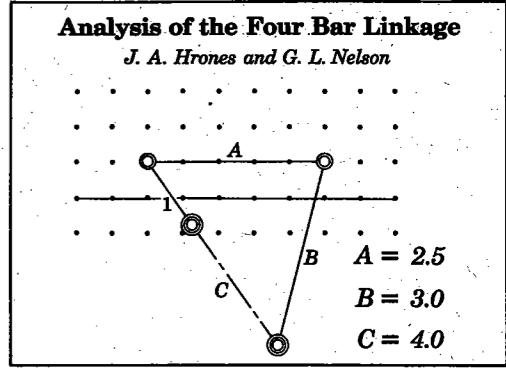

from  
 Design of Machinery 4ed  
 by Robert L. Norton  
 McGraw-Hill  
 © copyright 2008

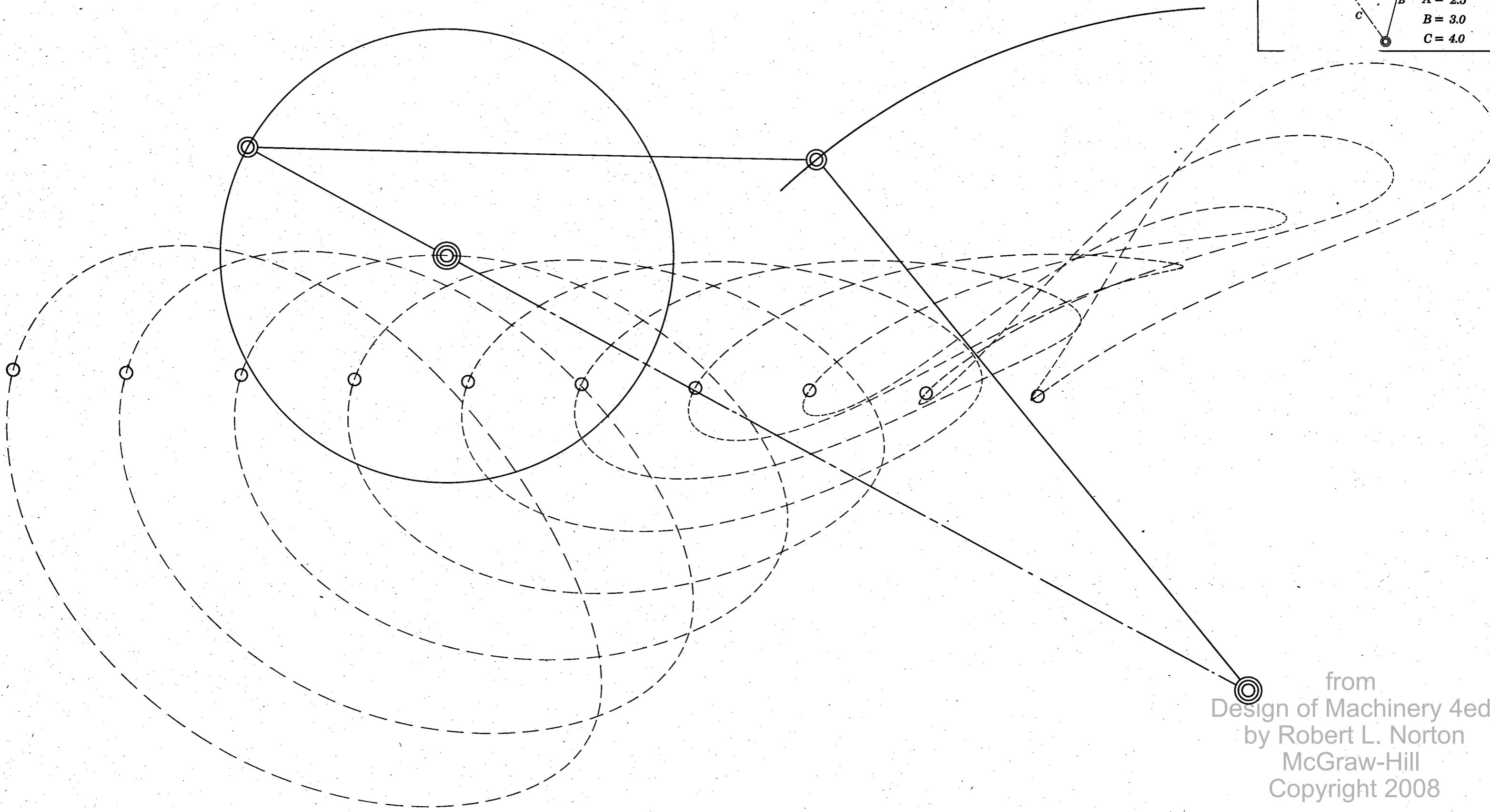
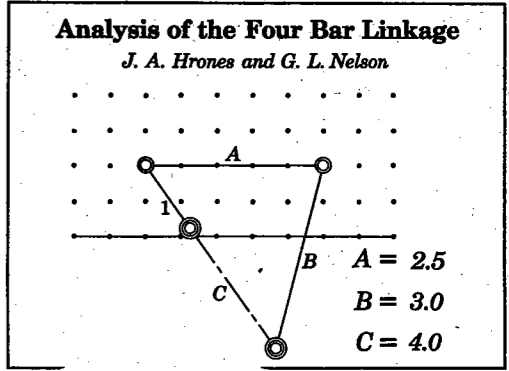

from  
Design of Machinery 4ed  
by Robert L. Norton  
McGraw-Hill  
Copyright 2008

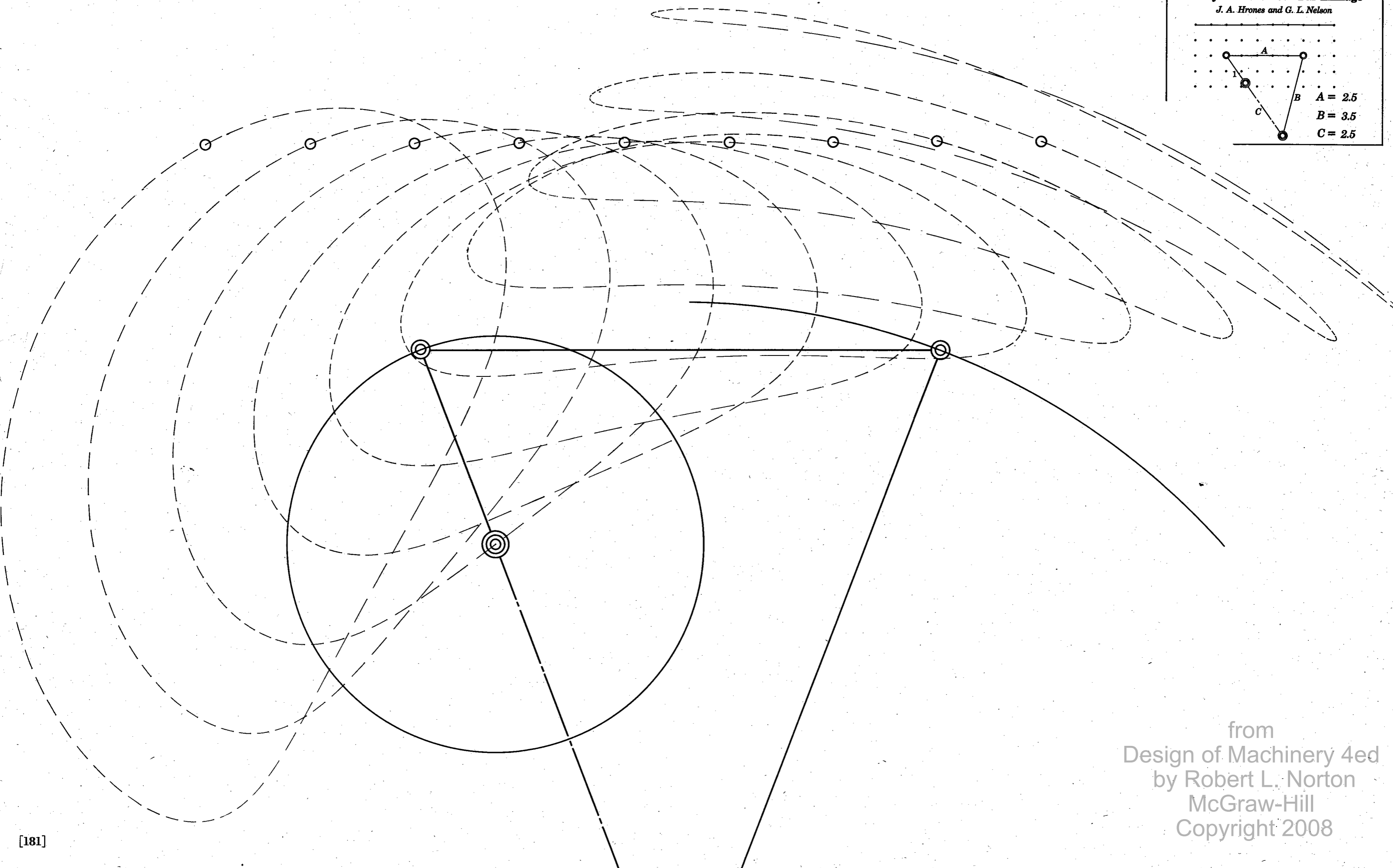
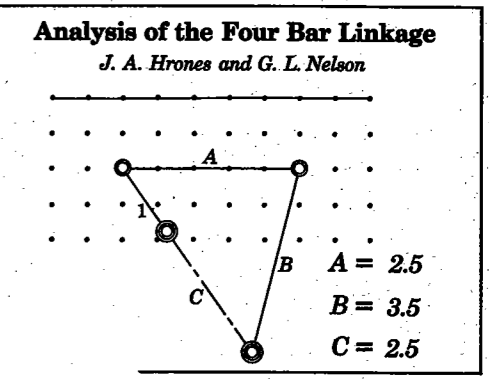

from  
 Design of Machinery 4ed  
 by Robert L. Norton  
 McGraw-Hill  
 Copyright 2008

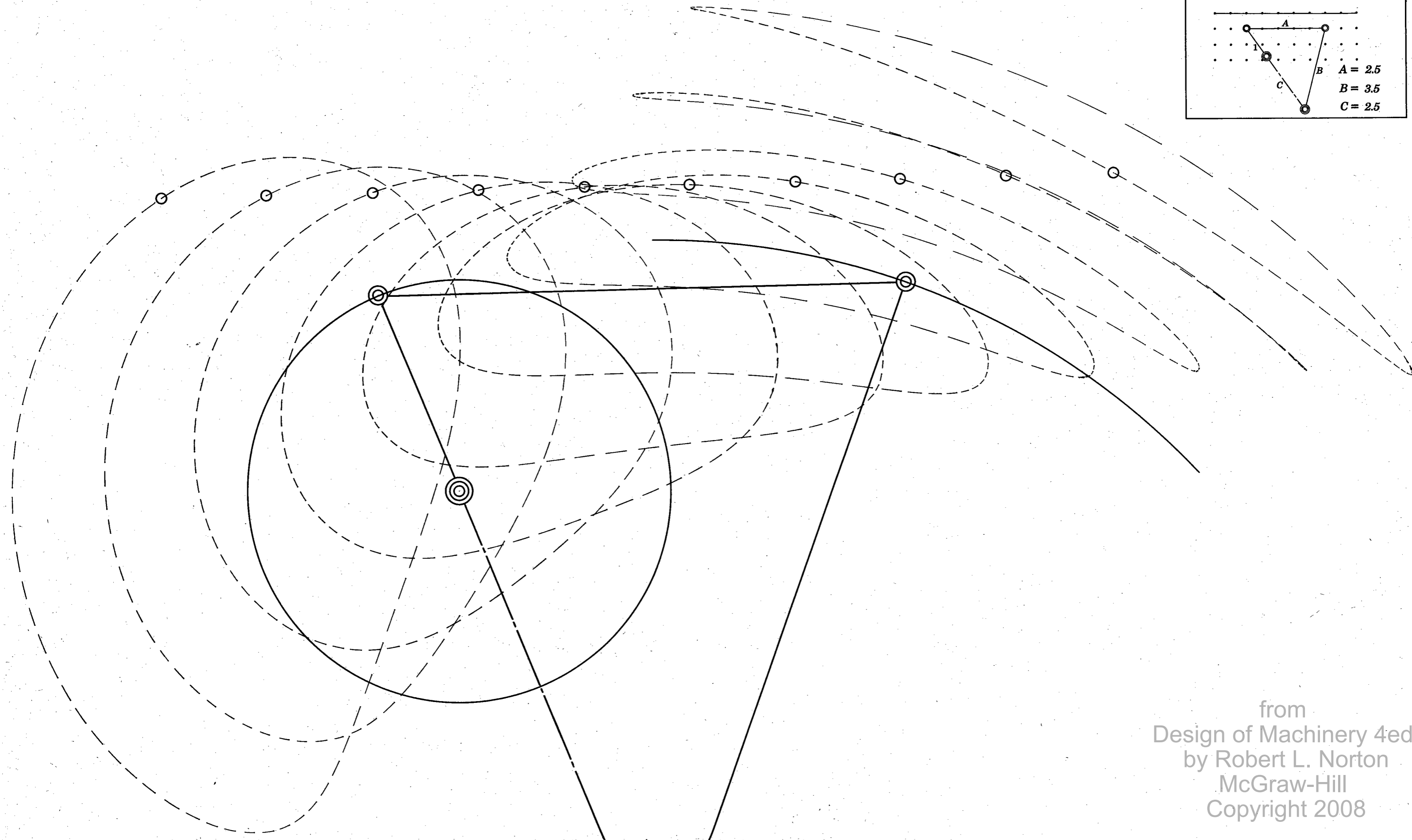
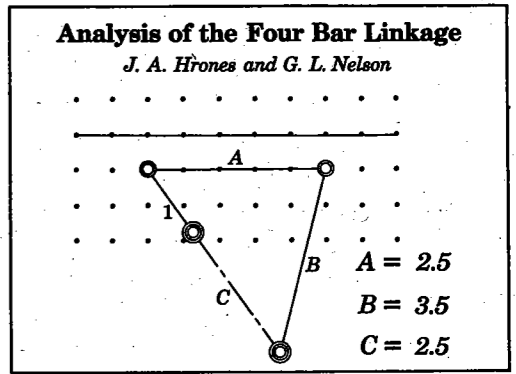

from  
Design of Machinery 4ed  
by Robert L. Norton  
McGraw-Hill  
Copyright 2008

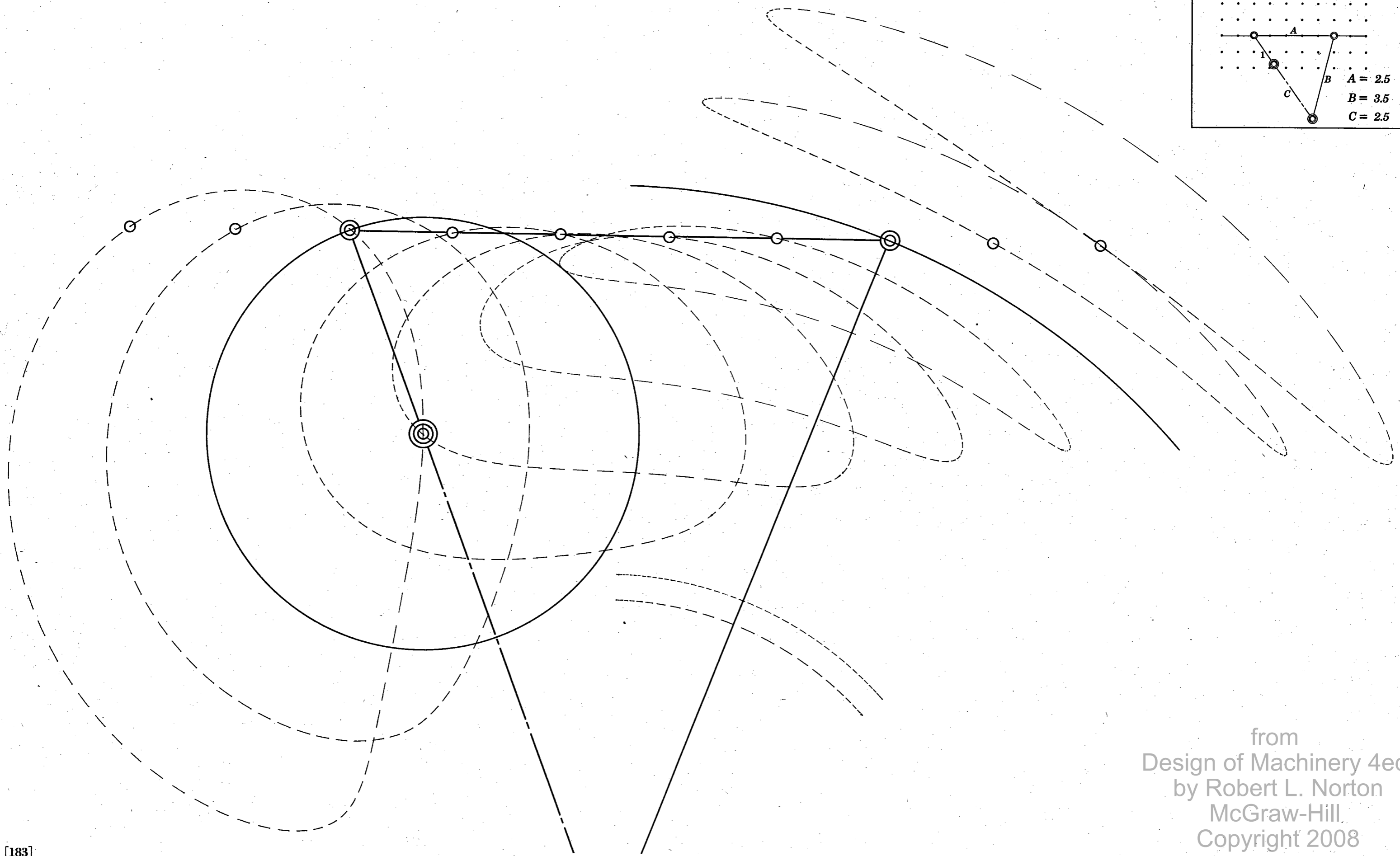
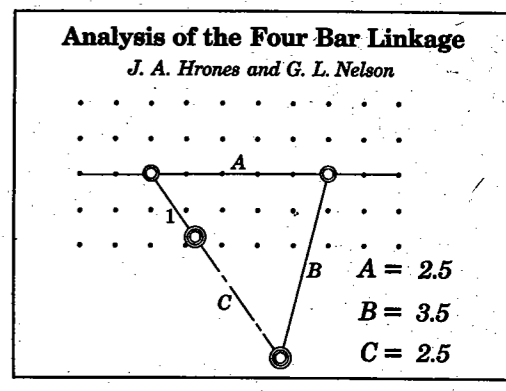

from  
 Design of Machinery 4ed  
 by Robert L. Norton  
 McGraw-Hill  
 Copyright 2008

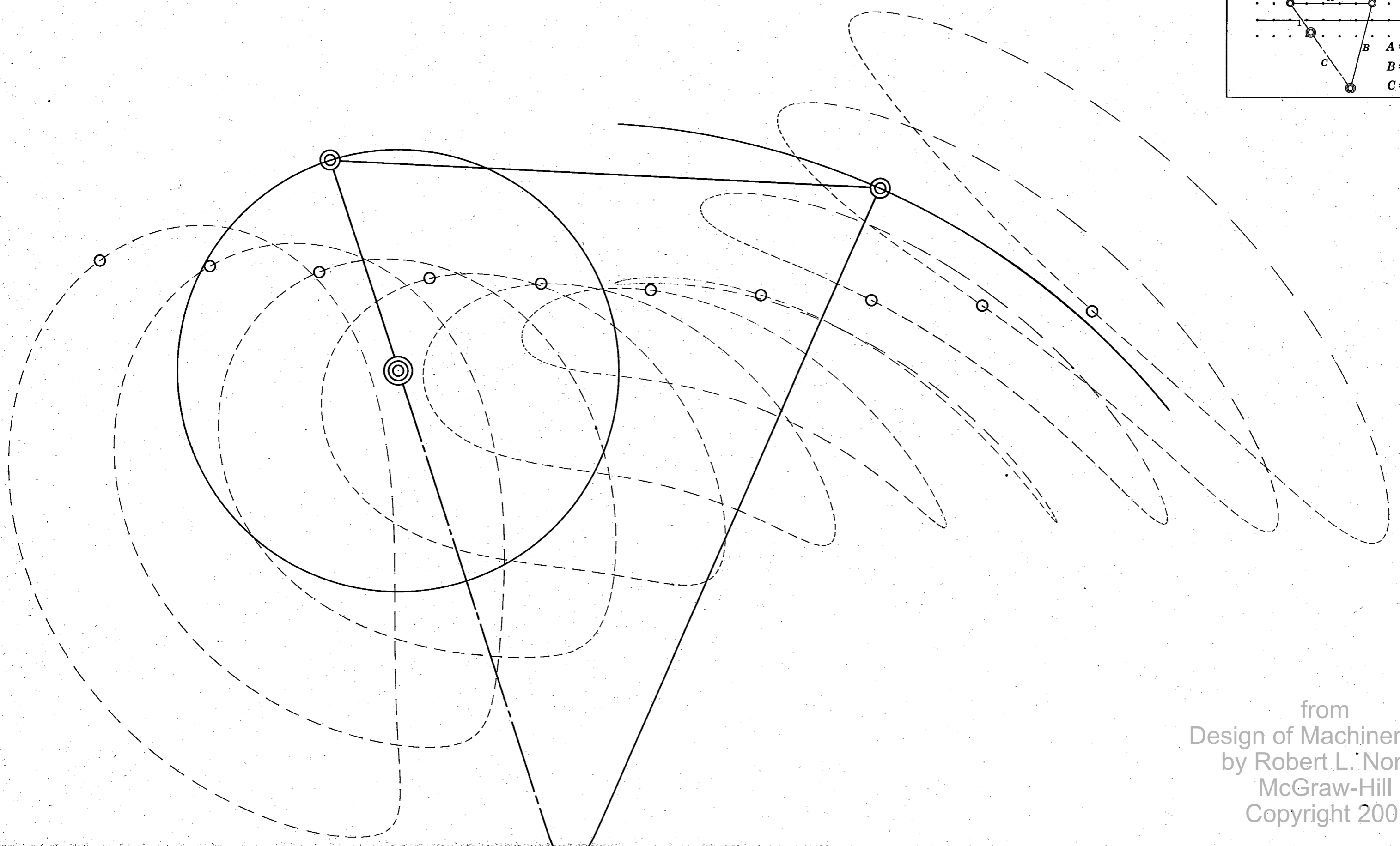
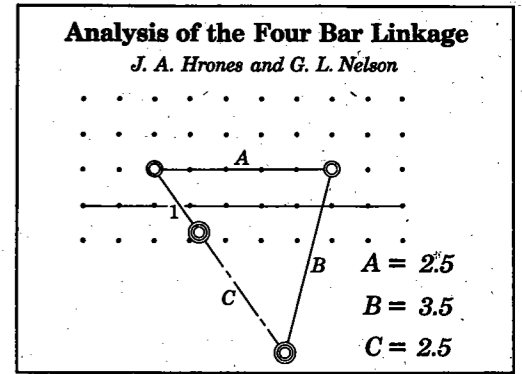

from  
Design of Machinery 4ed  
by Robert L. Norton  
McGraw-Hill  
Copyright 2008

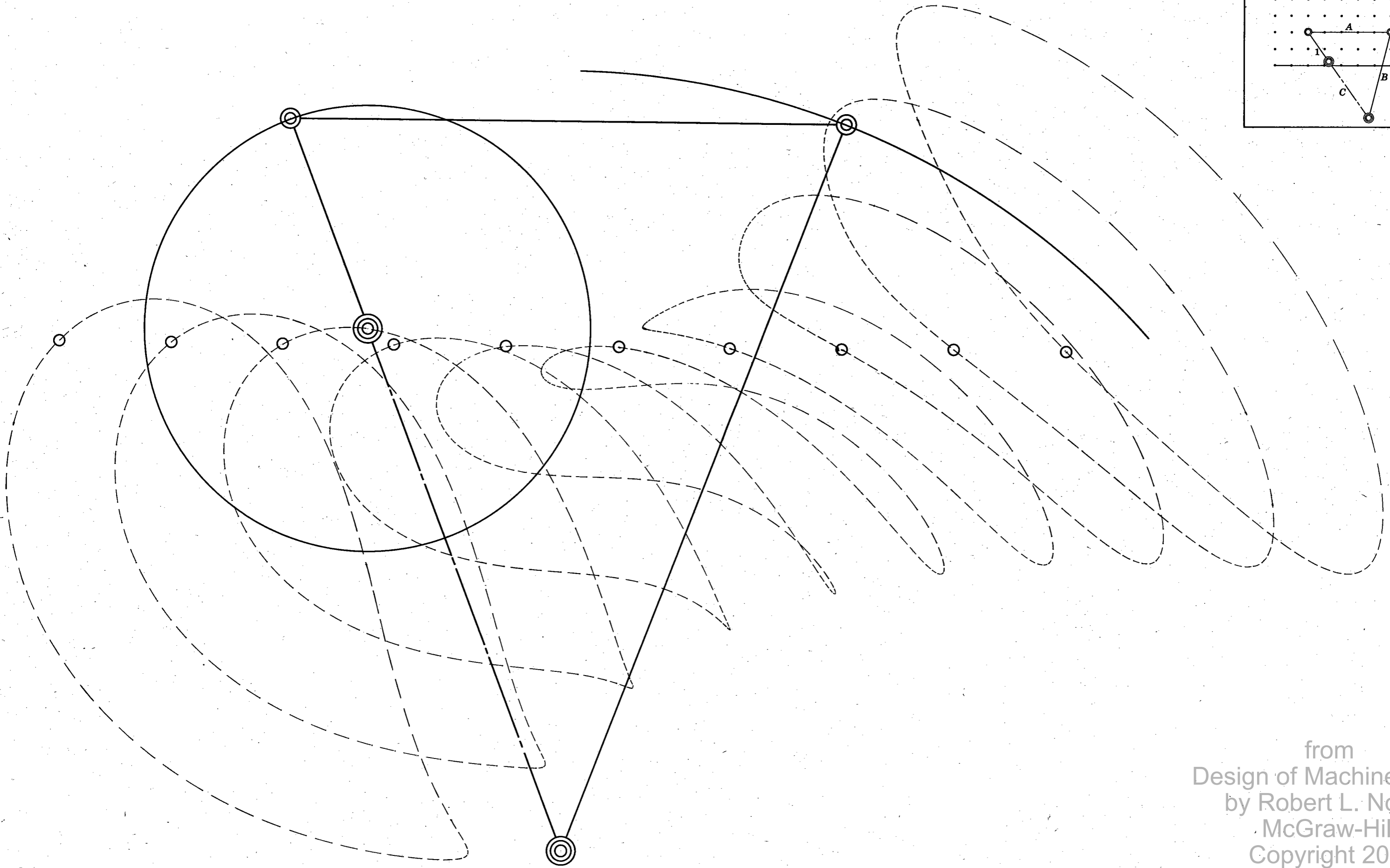
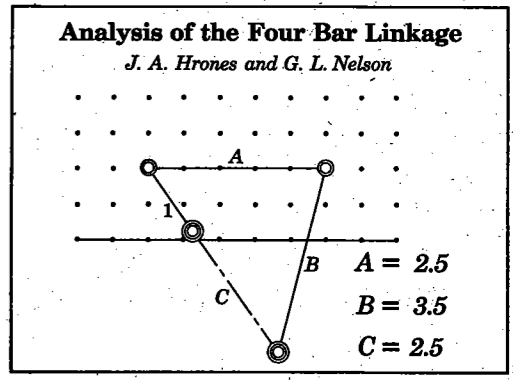

from  
 Design of Machinery 4ed  
 by Robert L. Norton  
 McGraw-Hill  
 Copyright 2008



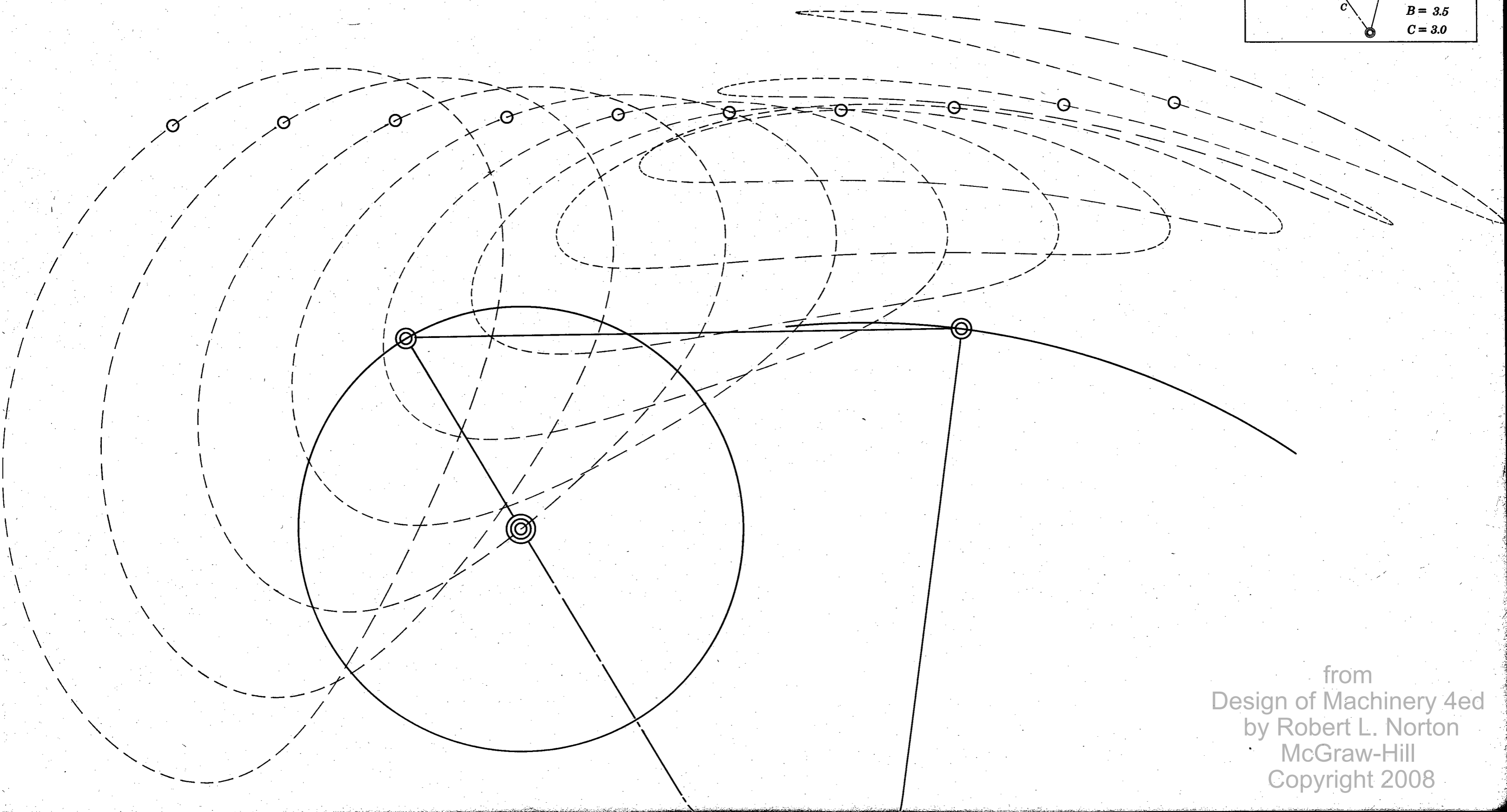
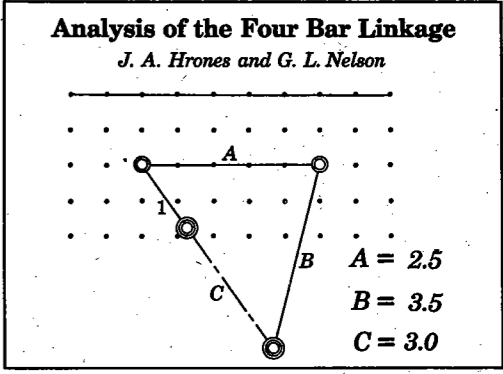

from  
Design of Machinery 4ed  
by Robert L. Norton  
McGraw-Hill  
Copyright 2008

**Analysis of the Four Bar Linkage**  
*J. A. Hrones and G. L. Nelson*

$A = 2.5$   
 $B = 3.5$   
 $C = 3.0$

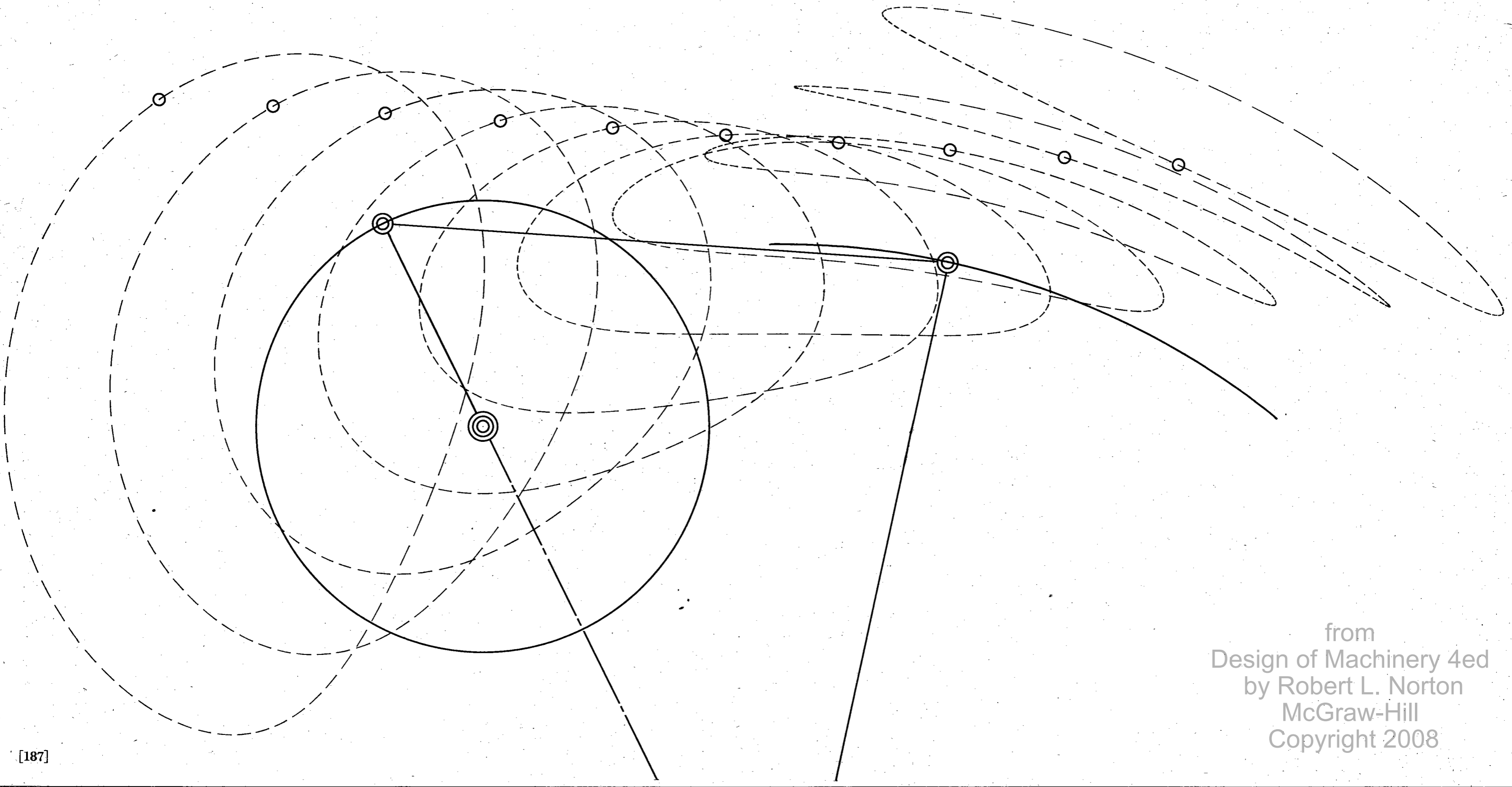

from  
 Design of Machinery 4ed  
 by Robert L. Norton  
 McGraw-Hill  
 Copyright 2008

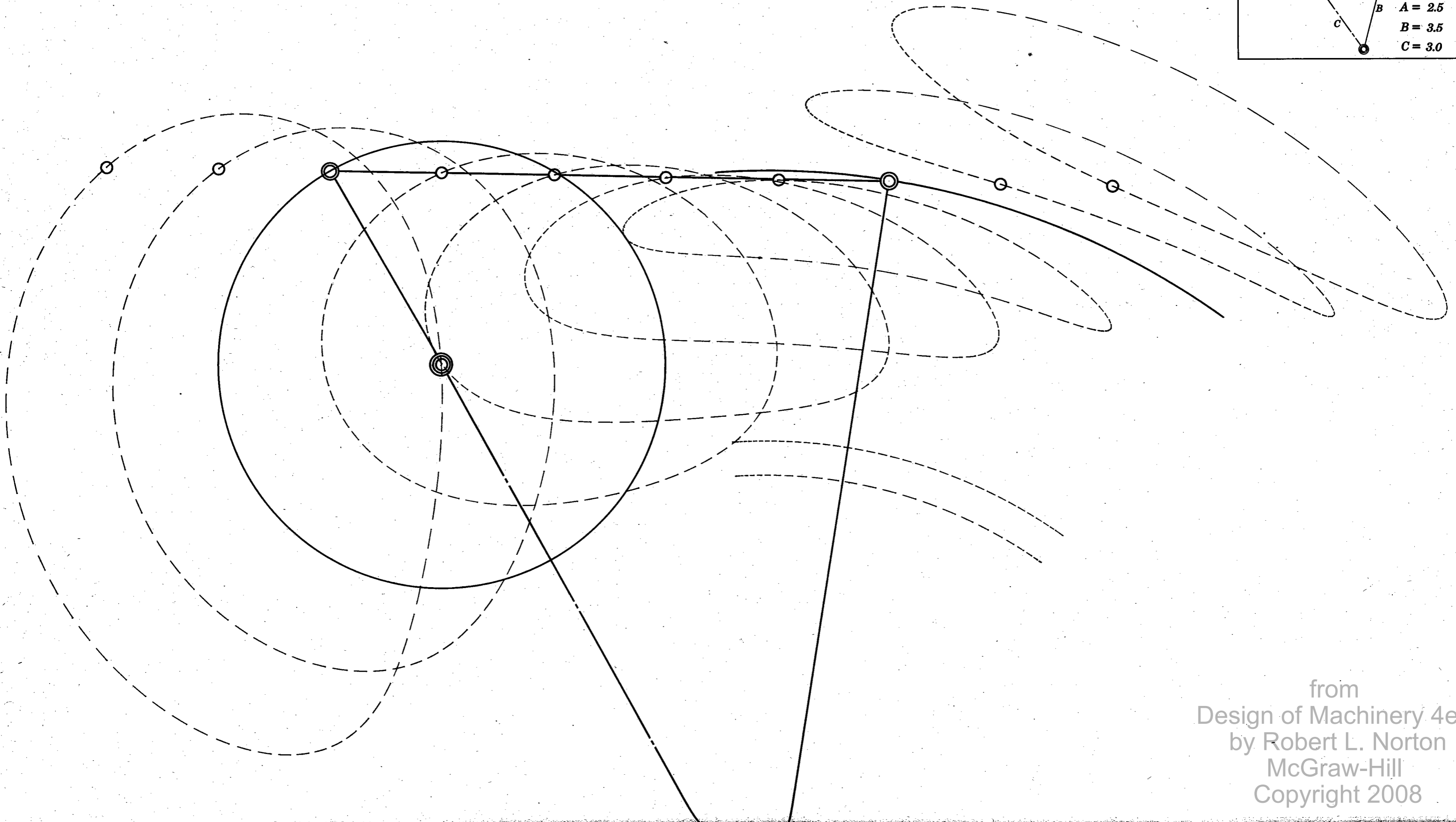
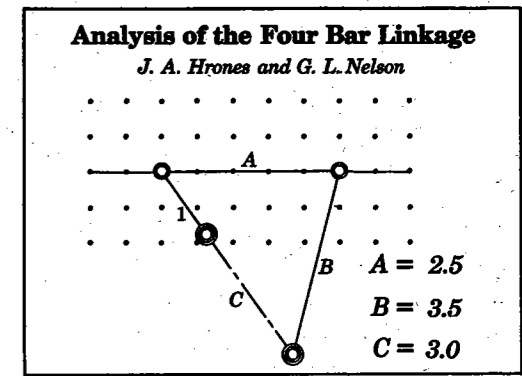

from  
Design of Machinery 4ed  
by Robert L. Norton  
McGraw-Hill  
Copyright 2008

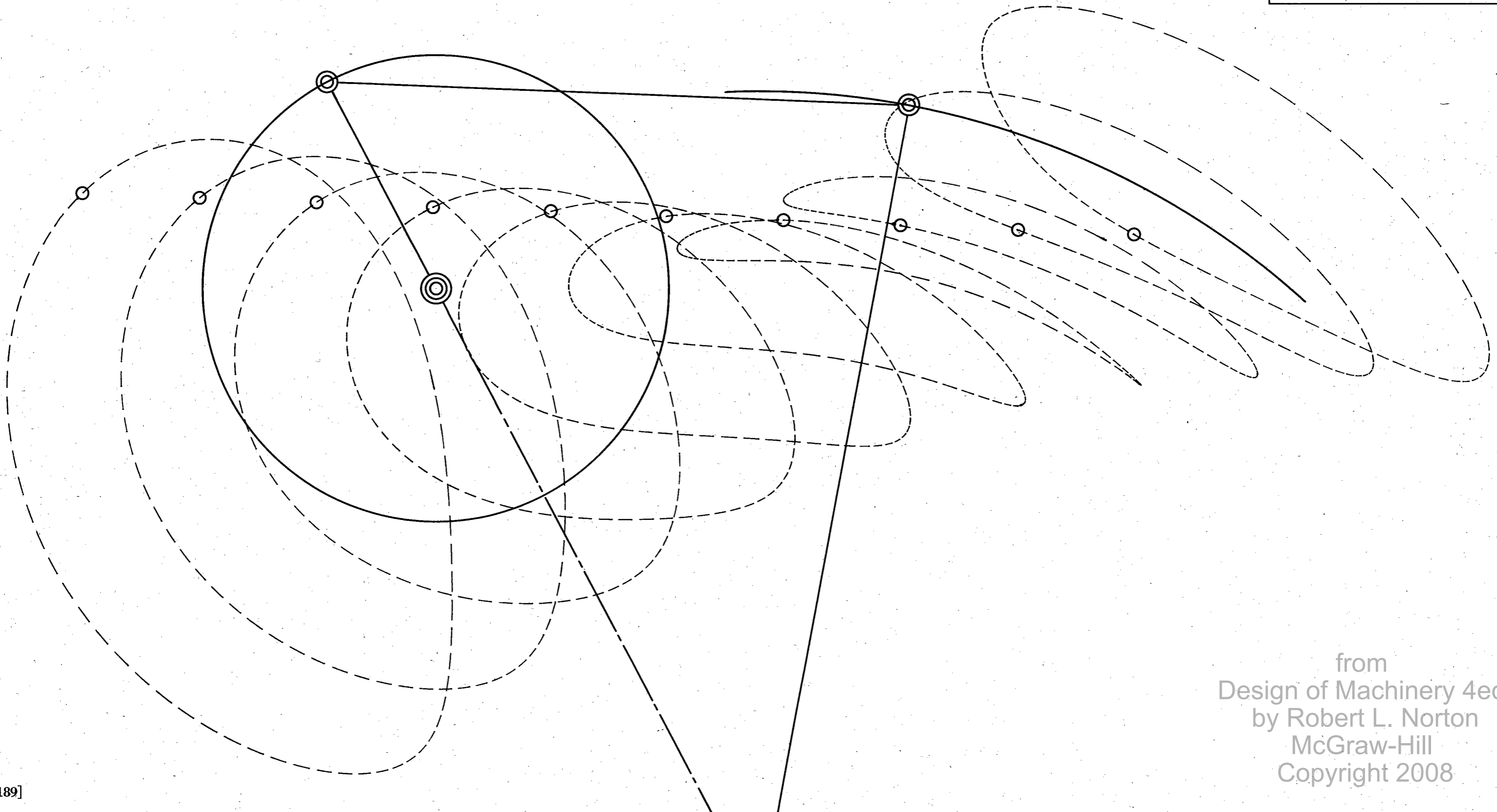
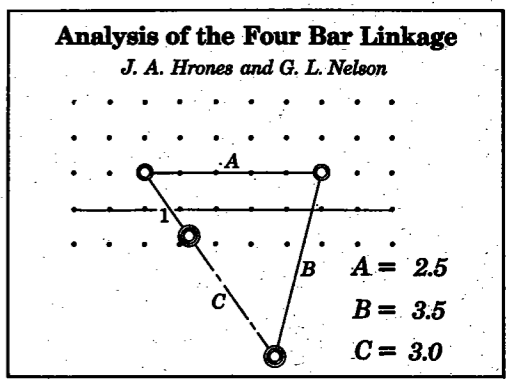

from  
 Design of Machinery 4ed  
 by Robert L. Norton  
 McGraw-Hill  
 Copyright 2008

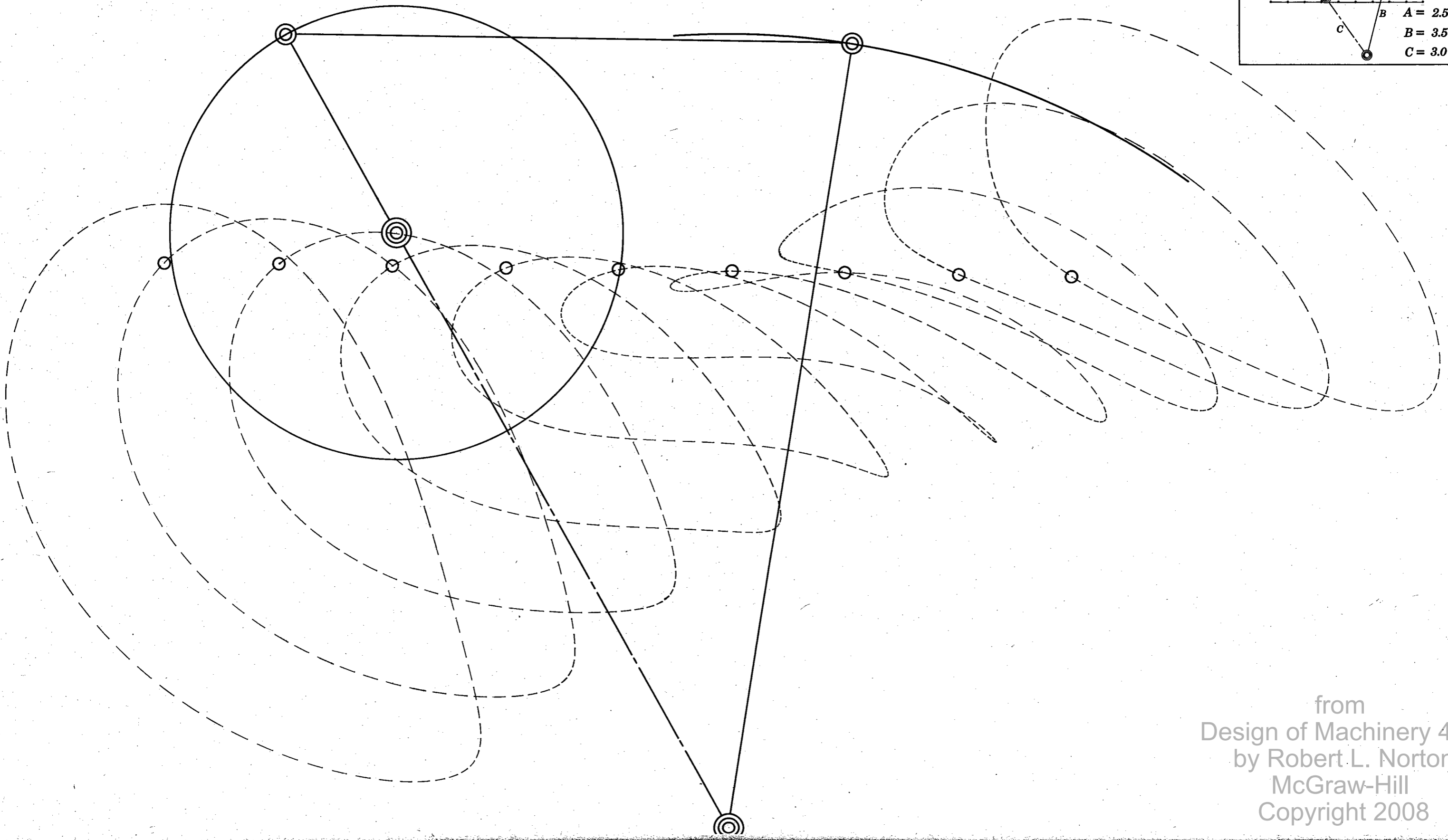
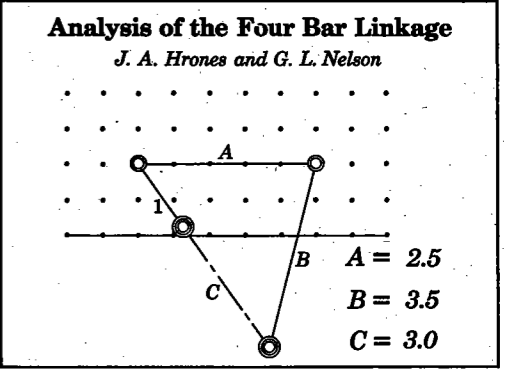

from  
Design of Machinery 4ed  
by Robert L. Norton  
McGraw-Hill  
Copyright 2008

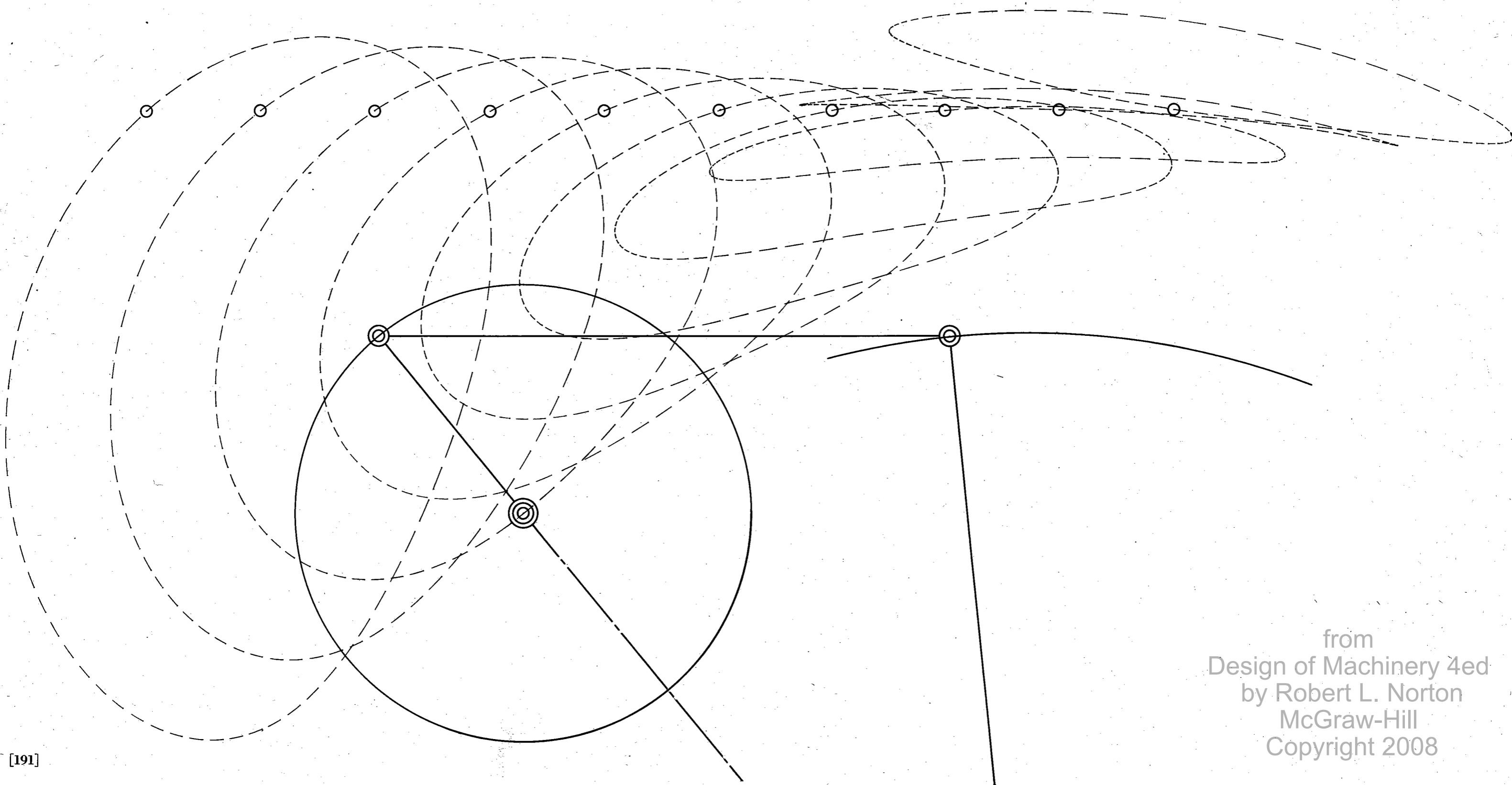
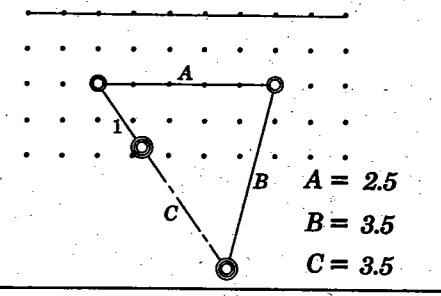

from  
Design of Machinery 4ed  
by Robert L. Norton  
McGraw-Hill  
Copyright 2008

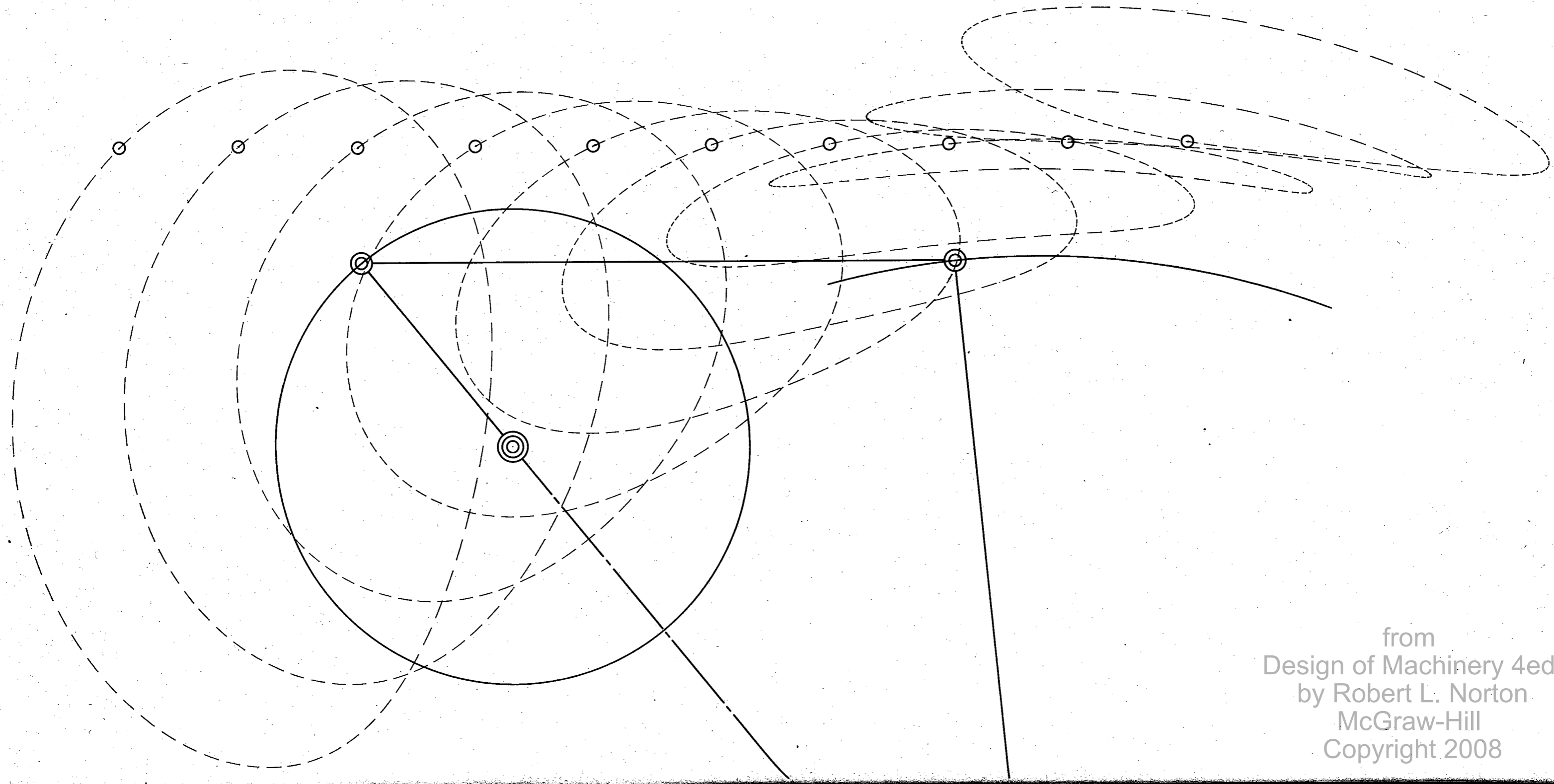
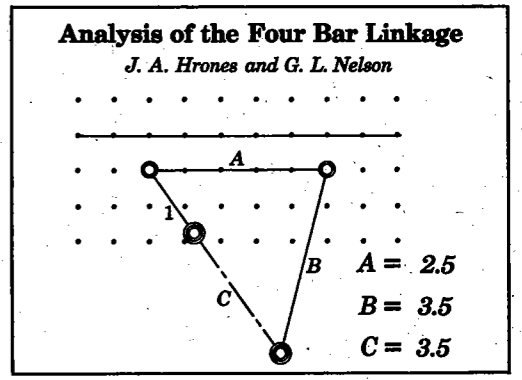

from  
Design of Machinery 4ed  
by Robert L. Norton  
McGraw-Hill  
Copyright 2008

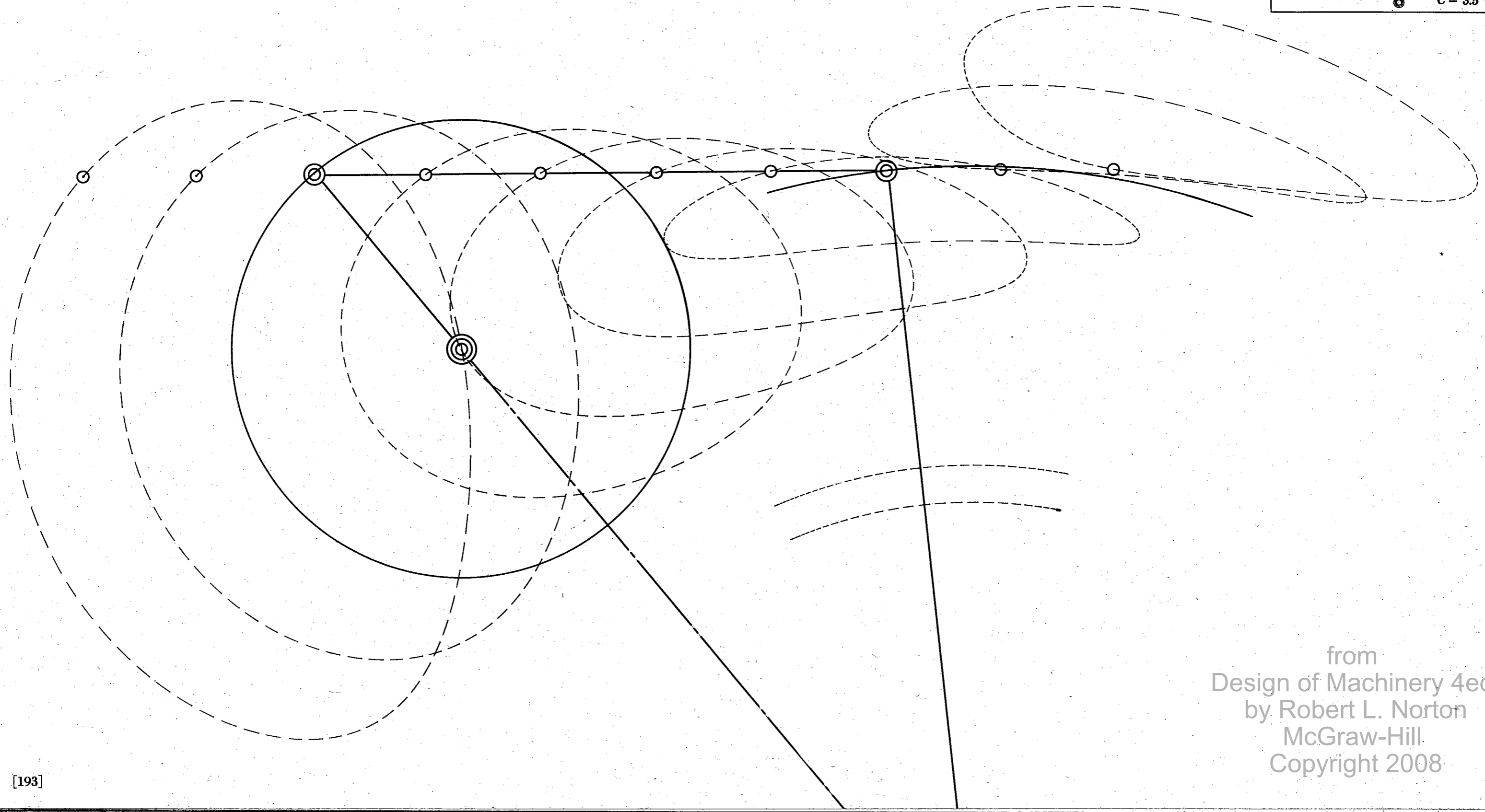
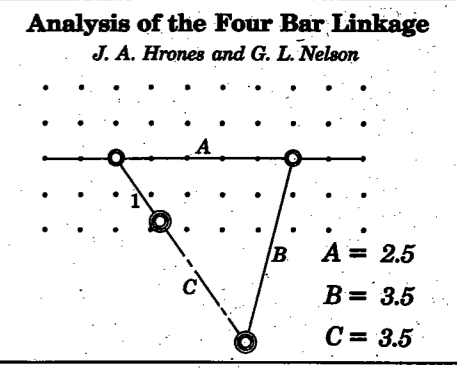

from  
 Design of Machinery 4ed  
 by Robert L. Norton  
 McGraw-Hill  
 Copyright 2008



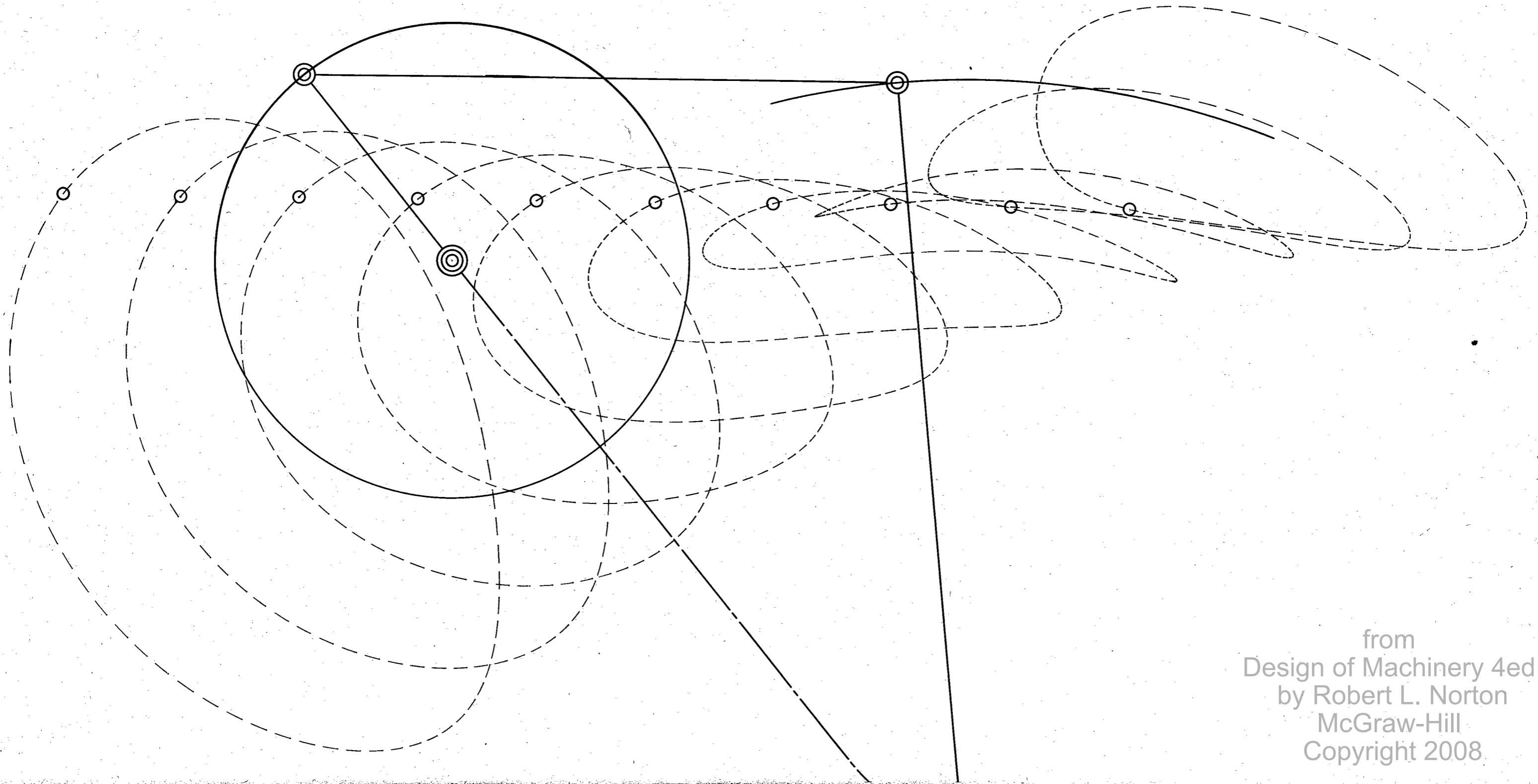
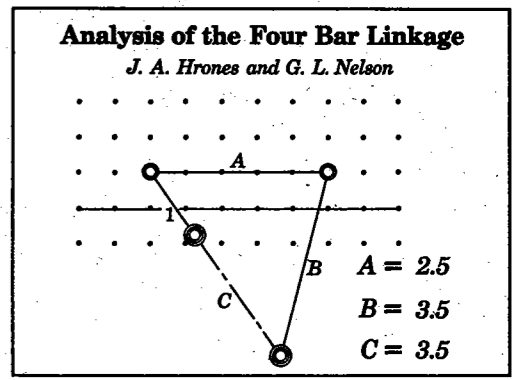

from  
Design of Machinery 4ed  
by Robert L. Norton  
McGraw-Hill  
Copyright 2008

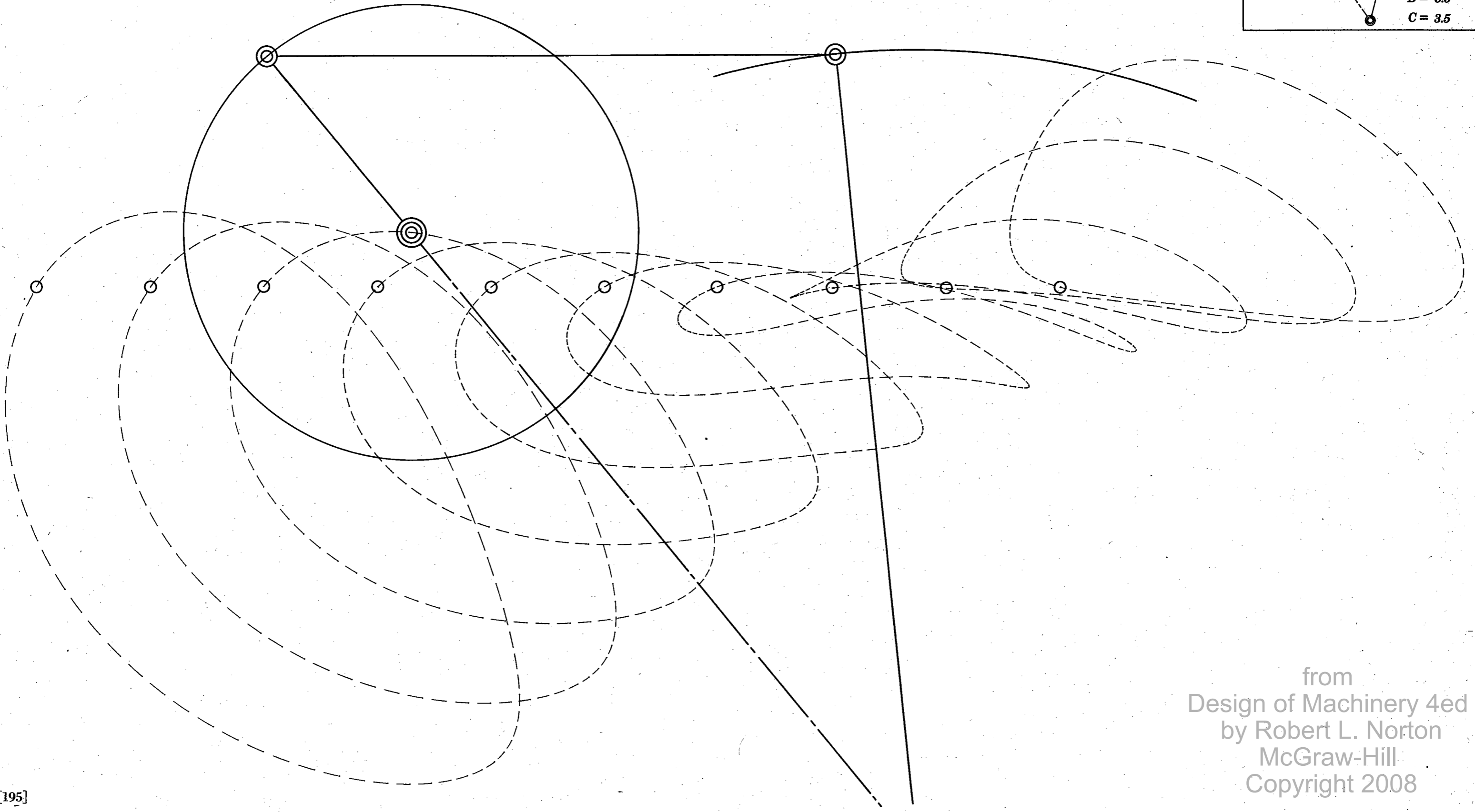
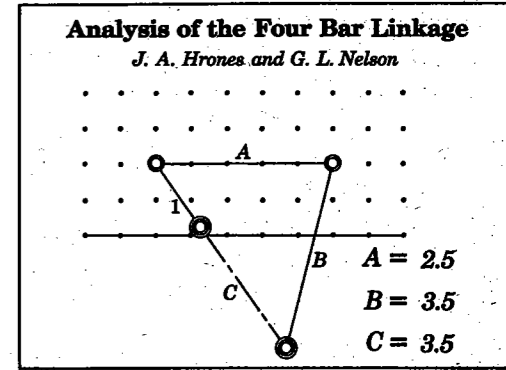

from  
 Design of Machinery 4ed  
 by Robert L. Norton  
 McGraw-Hill  
 Copyright 2008

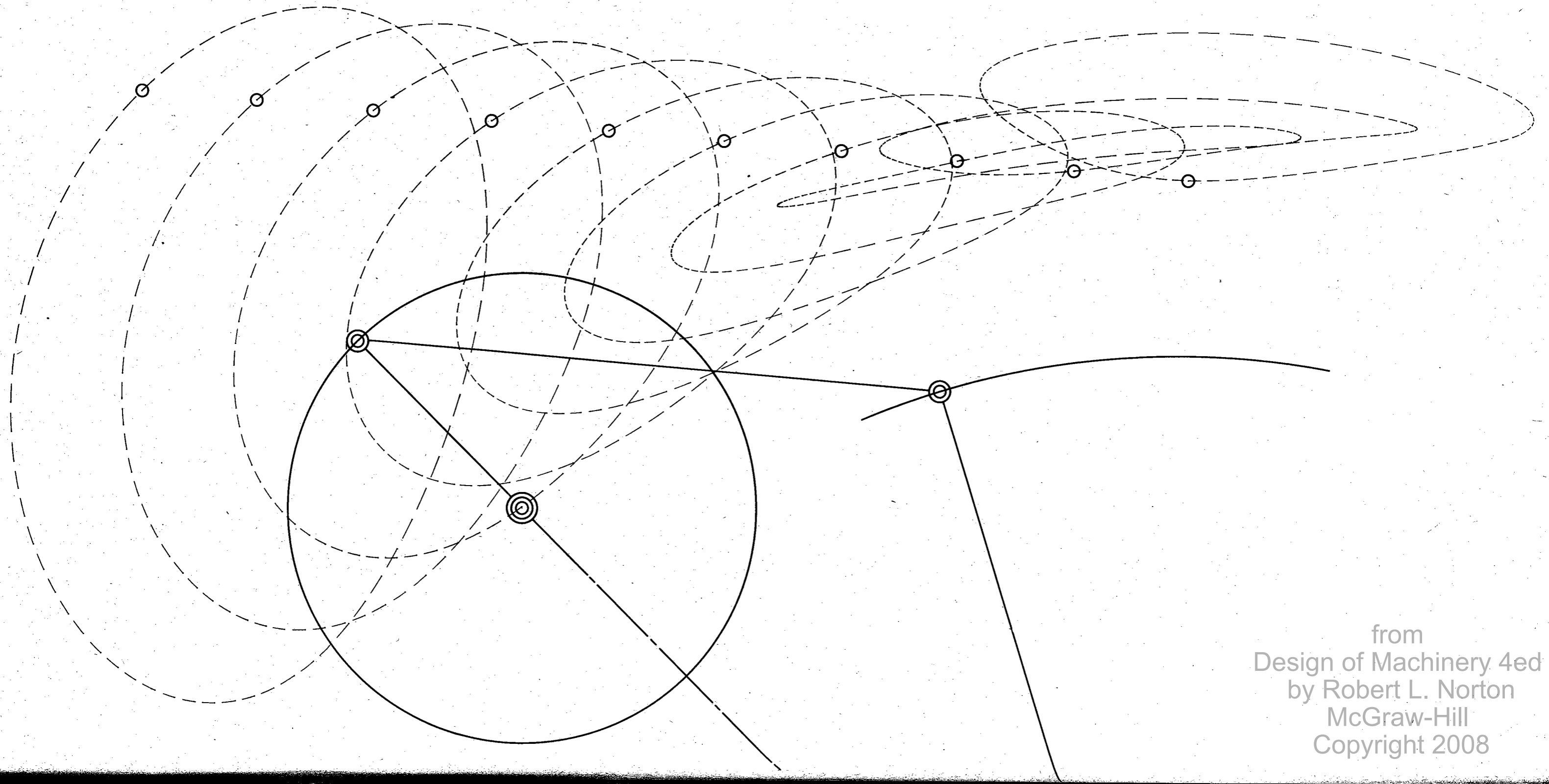
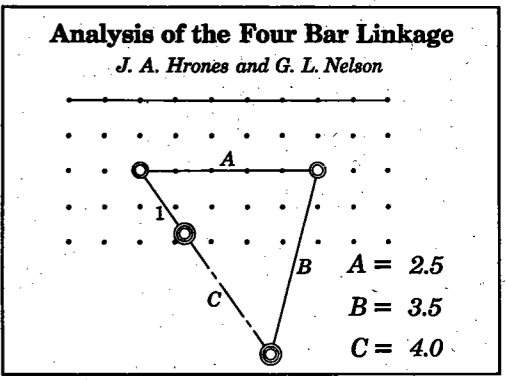

from  
Design of Machinery 4ed  
by Robert L. Norton  
McGraw-Hill  
Copyright 2008

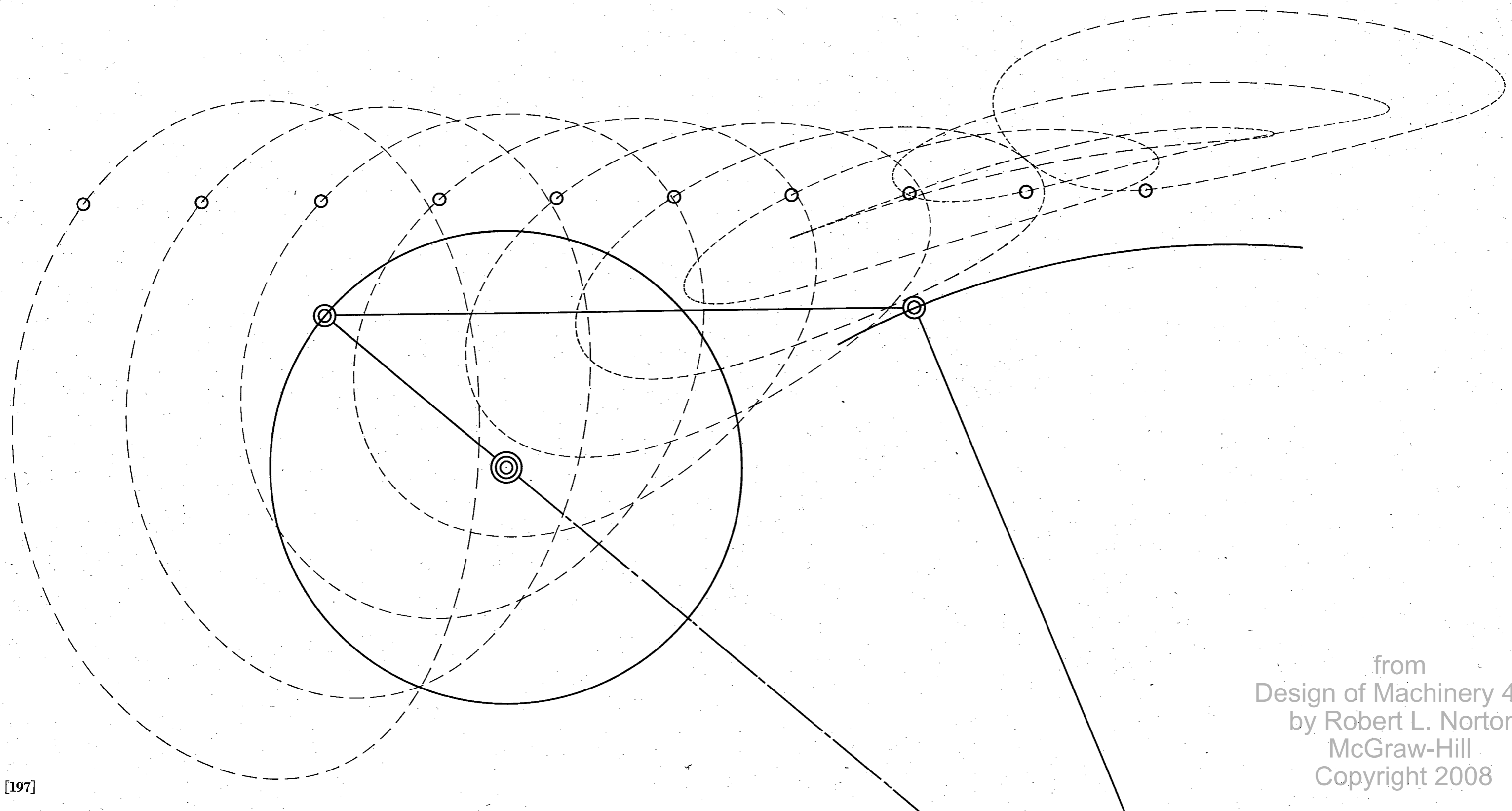
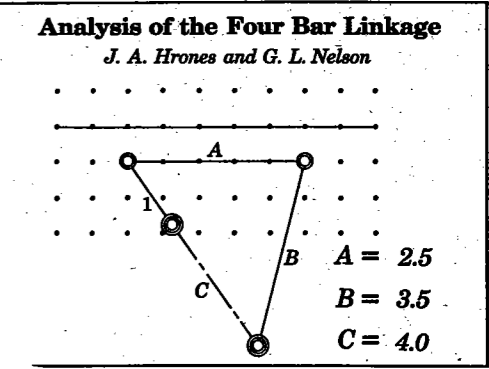

from  
 Design of Machinery 4ed  
 by Robert L. Norton  
 McGraw-Hill  
 Copyright 2008

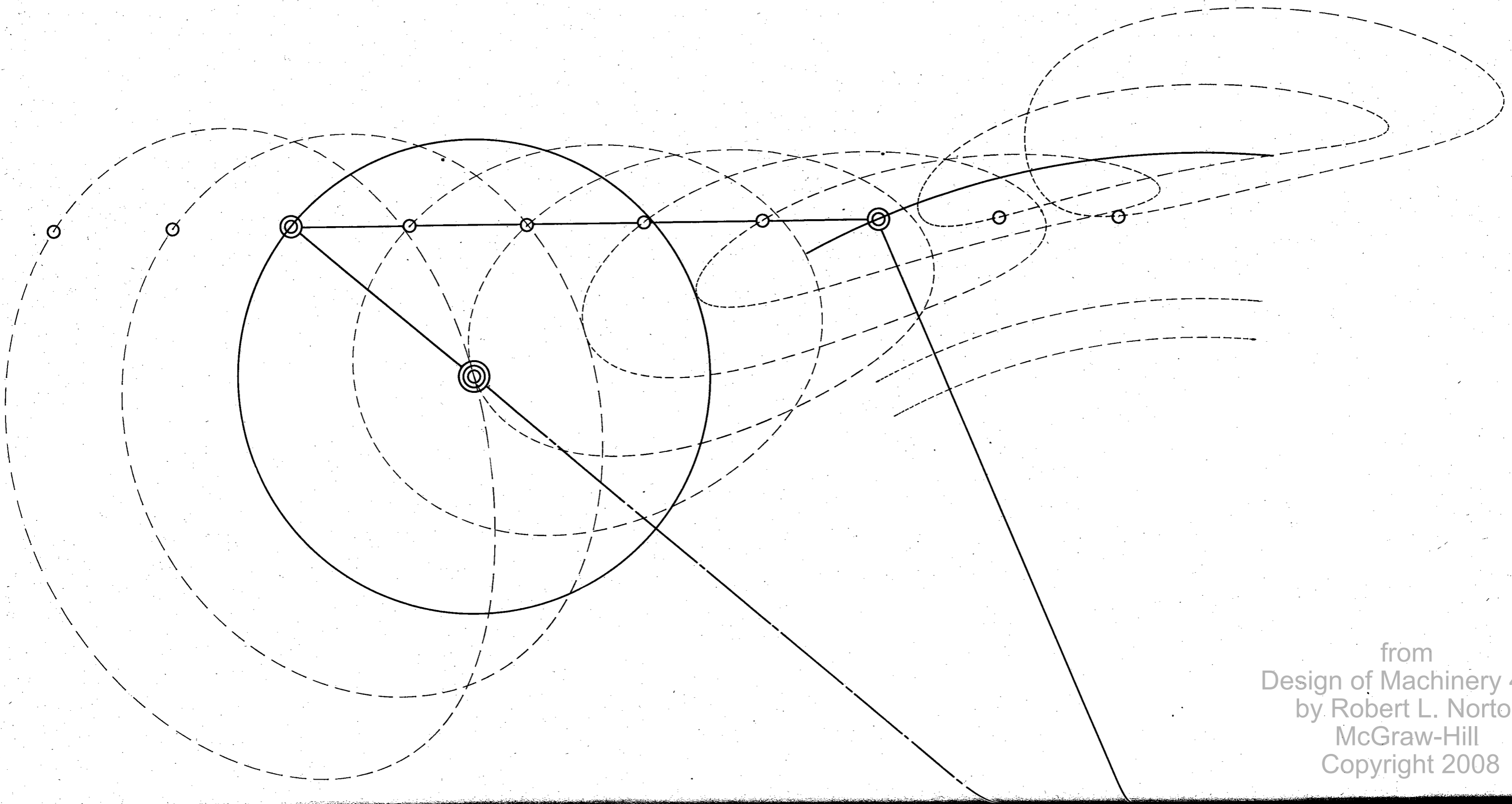
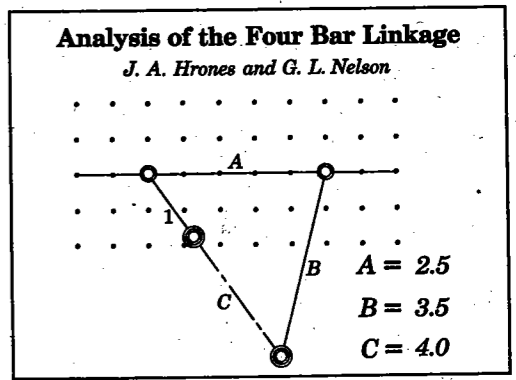

from  
Design of Machinery 4ed  
by Robert L. Norton  
McGraw-Hill  
Copyright 2008

**Analysis of the Four Bar Linkage**

*J. A. Hrones and G. L. Nelson*

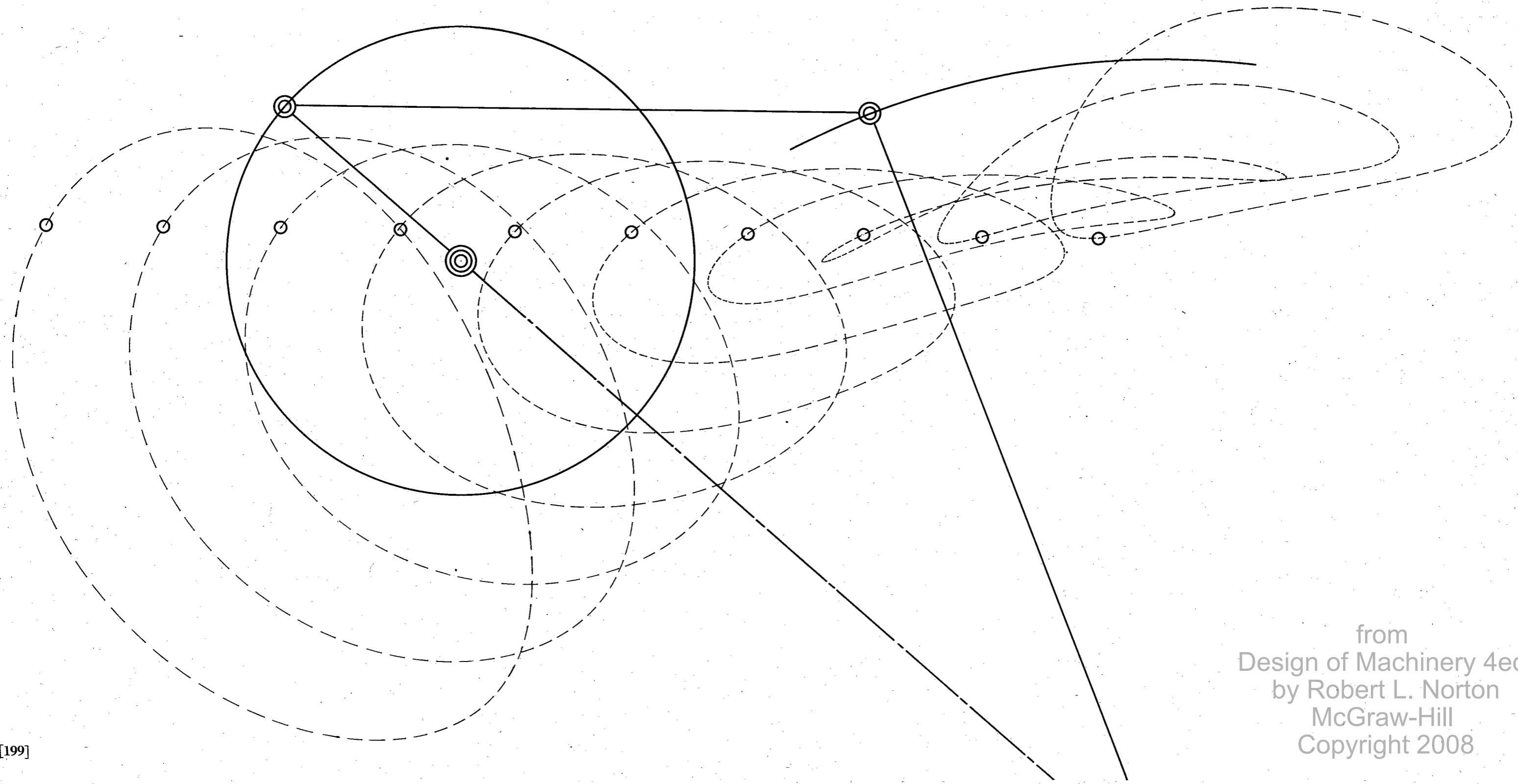
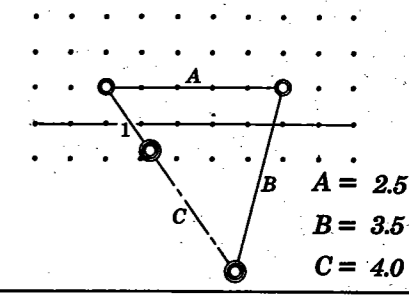

from  
Design of Machinery 4ed  
by Robert L. Norton  
McGraw-Hill  
Copyright 2008

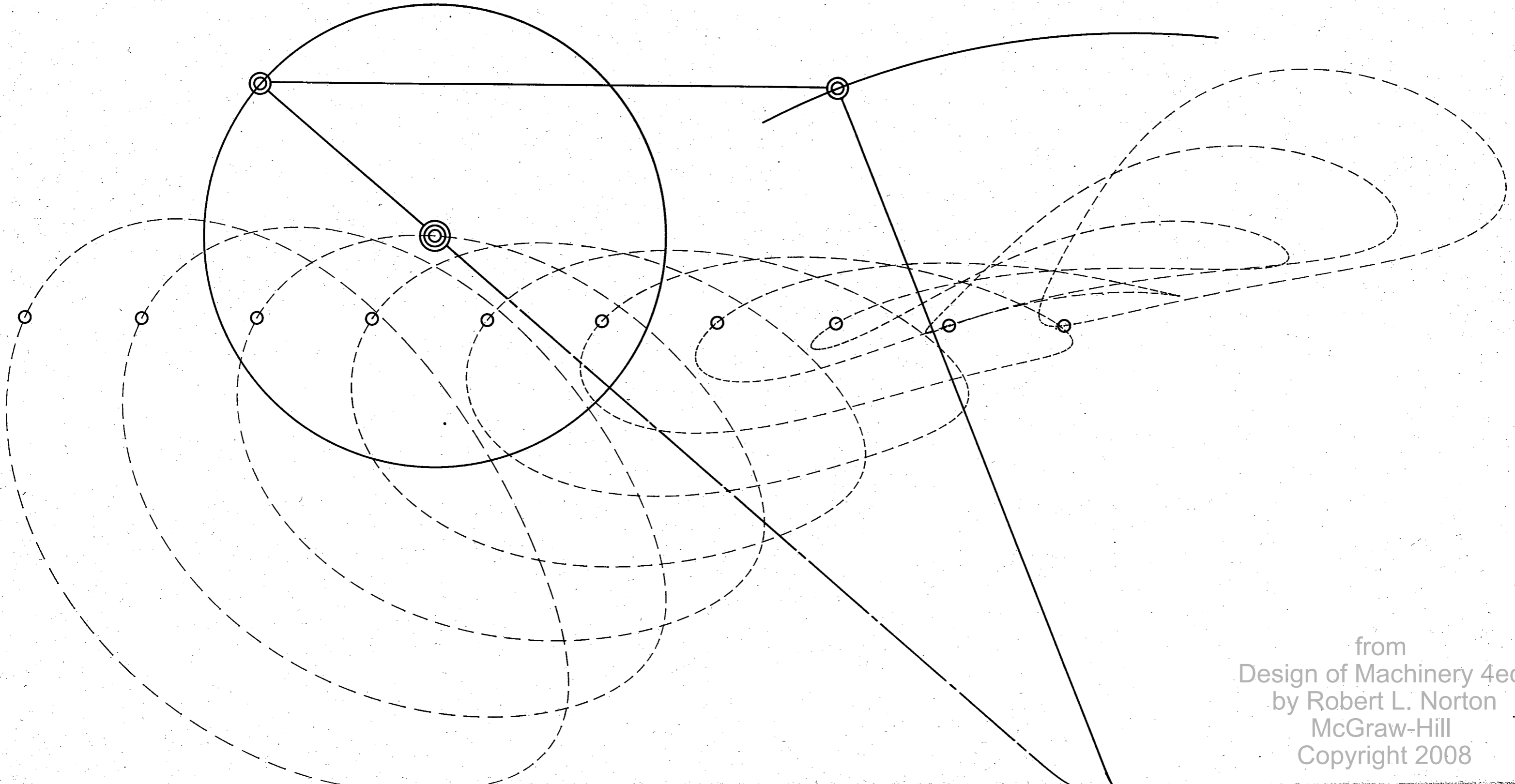
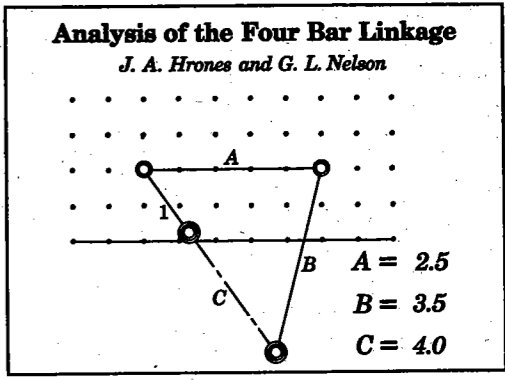

from  
Design of Machinery 4ed  
by Robert L. Norton  
McGraw-Hill  
Copyright 2008

**Analysis of the Four Bar Linkage**  
*J. A. Hrones and G. L. Nelson*

$A = 2.5$   
 $B = 3.5$   
 $C = 4.5$

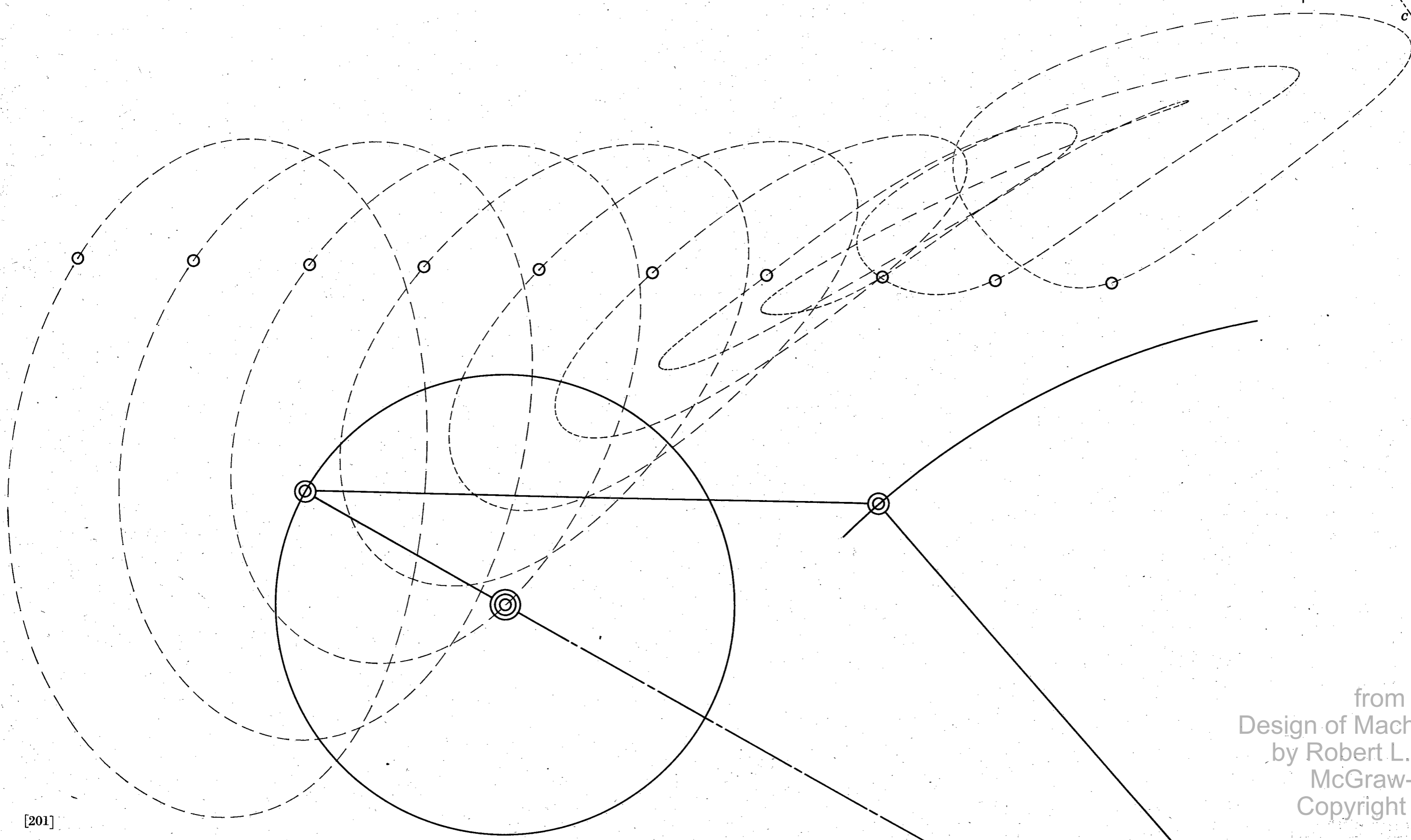

from  
 Design of Machinery 4ed  
 by Robert L. Norton  
 McGraw-Hill  
 Copyright 2008



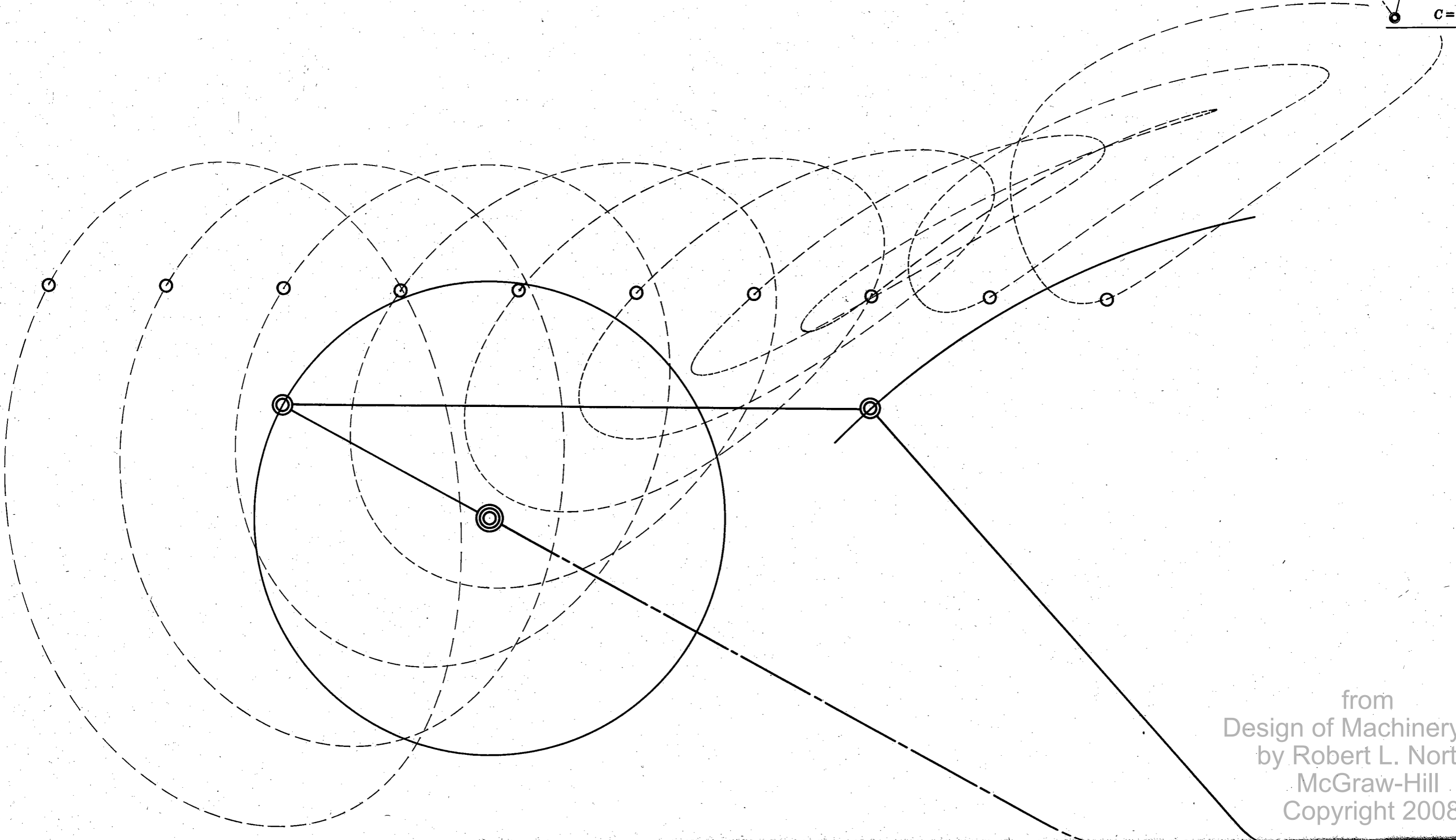
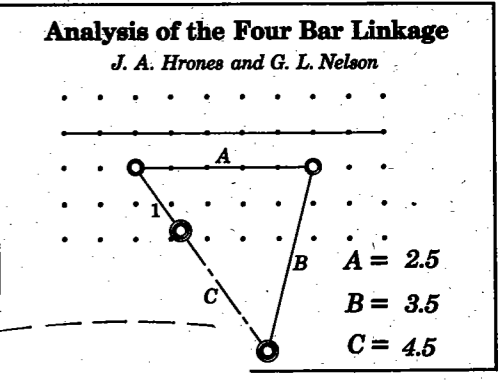

from  
Design of Machinery 4ed  
by Robert L. Norton  
McGraw-Hill  
Copyright 2008

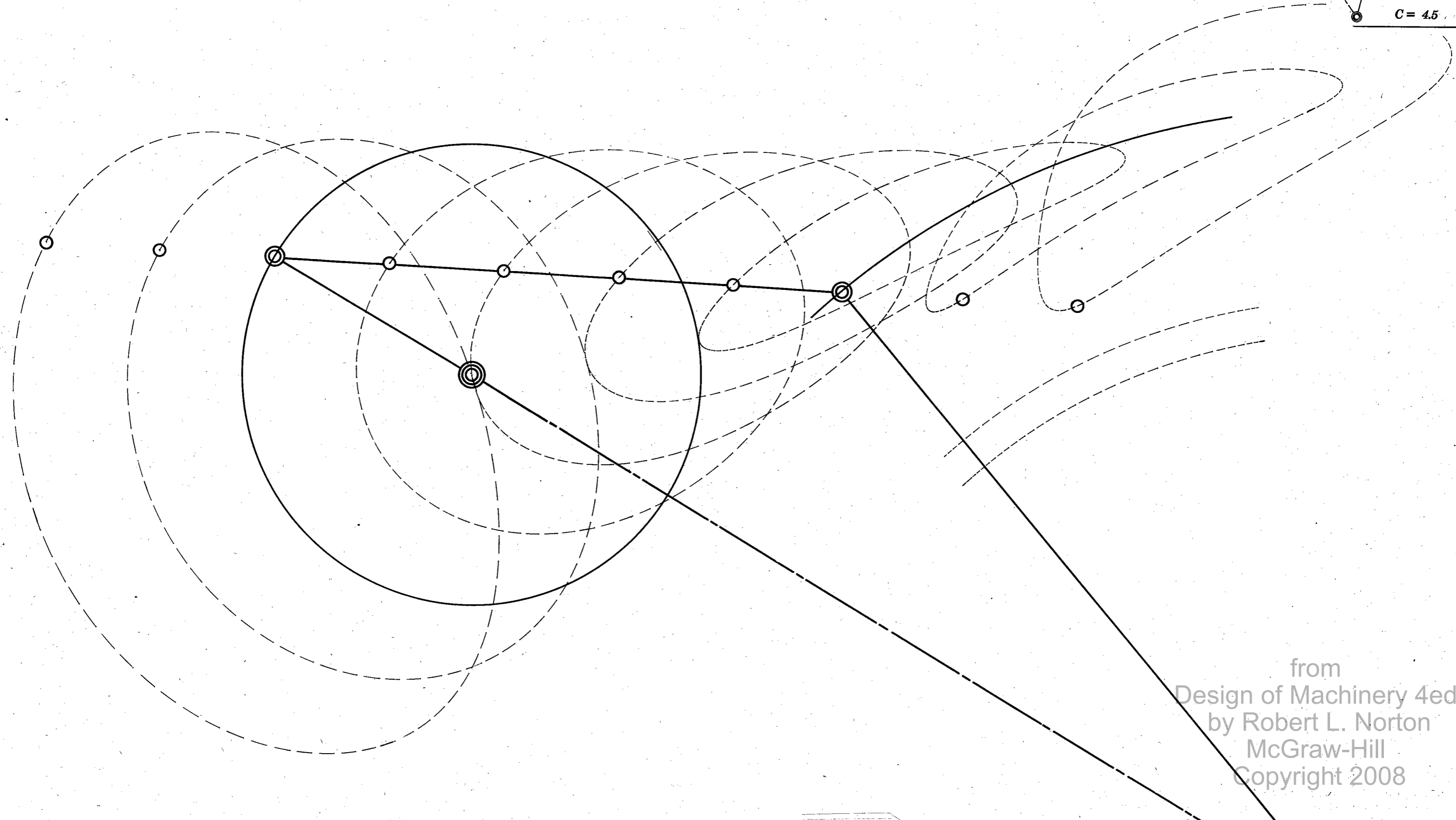
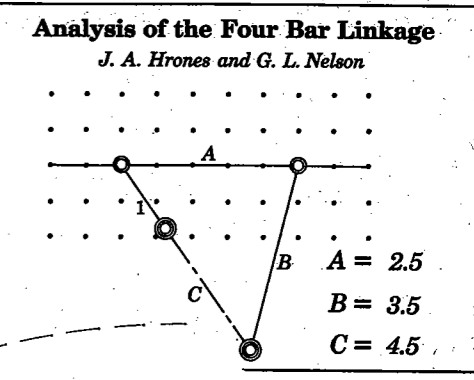

from  
 Design of Machinery 4ed  
 by Robert L. Norton  
 McGraw-Hill  
 Copyright 2008

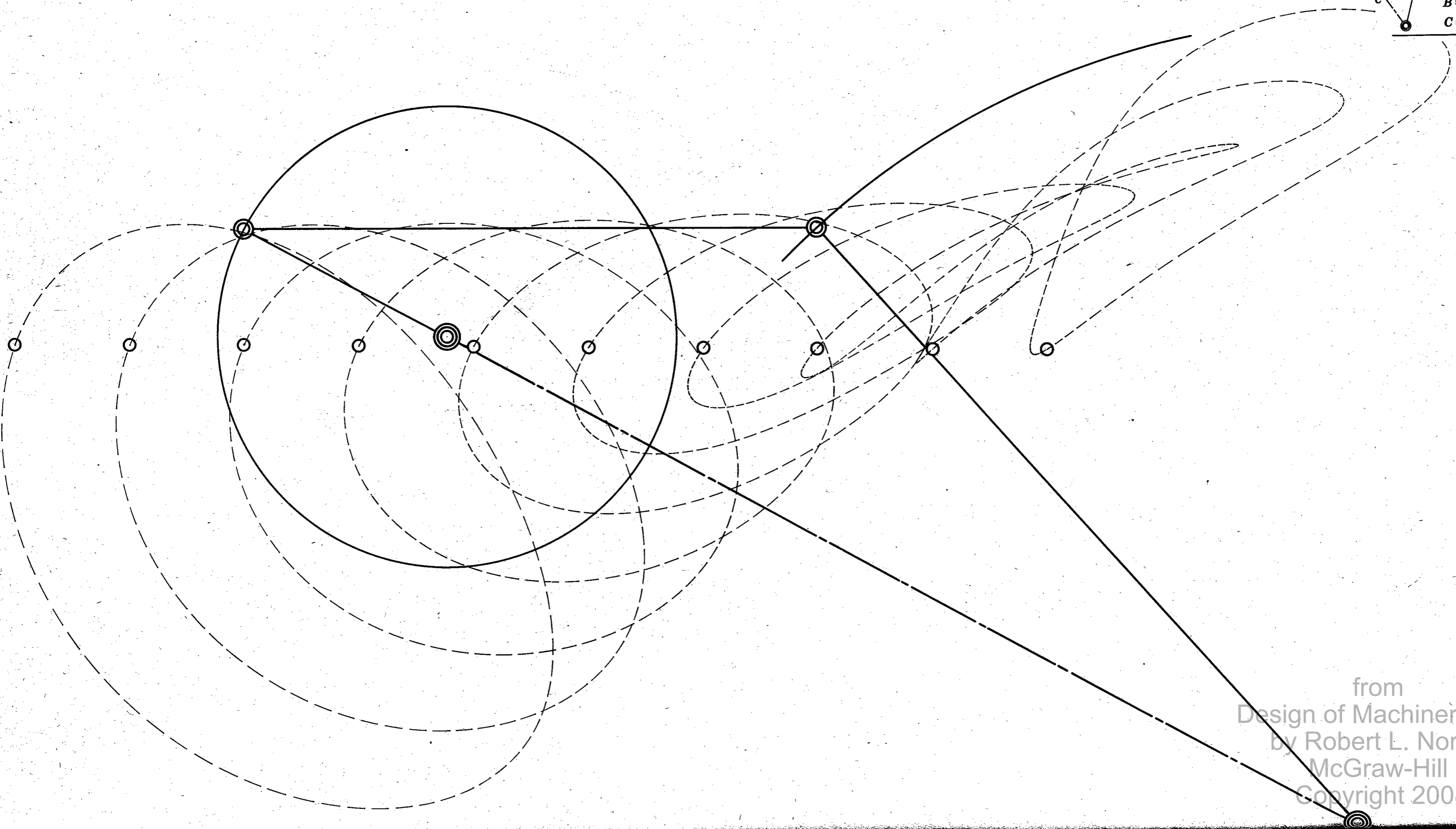
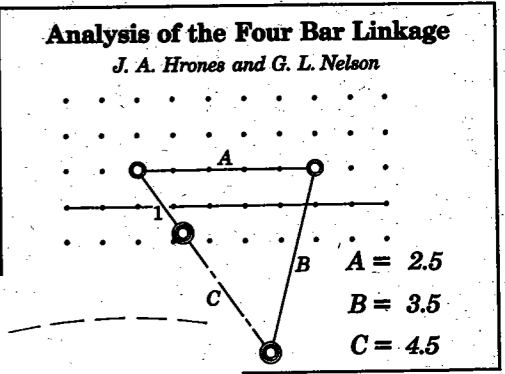

from  
Design of Machinery 4ed  
by Robert L. Norton  
McGraw-Hill  
Copyright 2008

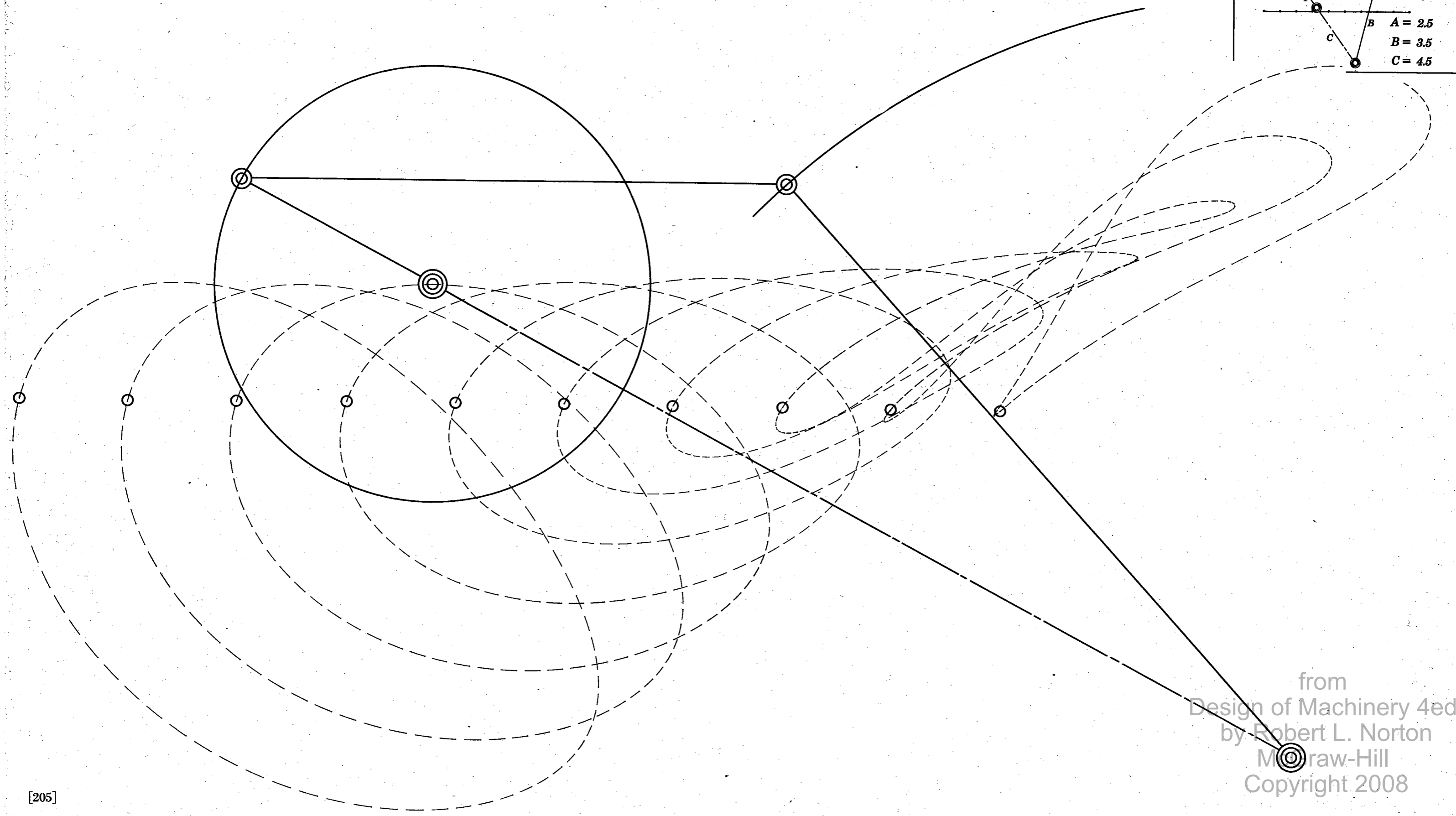
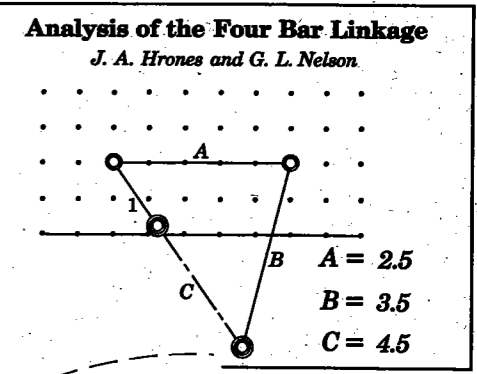

from  
 Design of Machinery 4ed  
 by Robert L. Norton  
 © Macraw-Hill  
 Copyright 2008

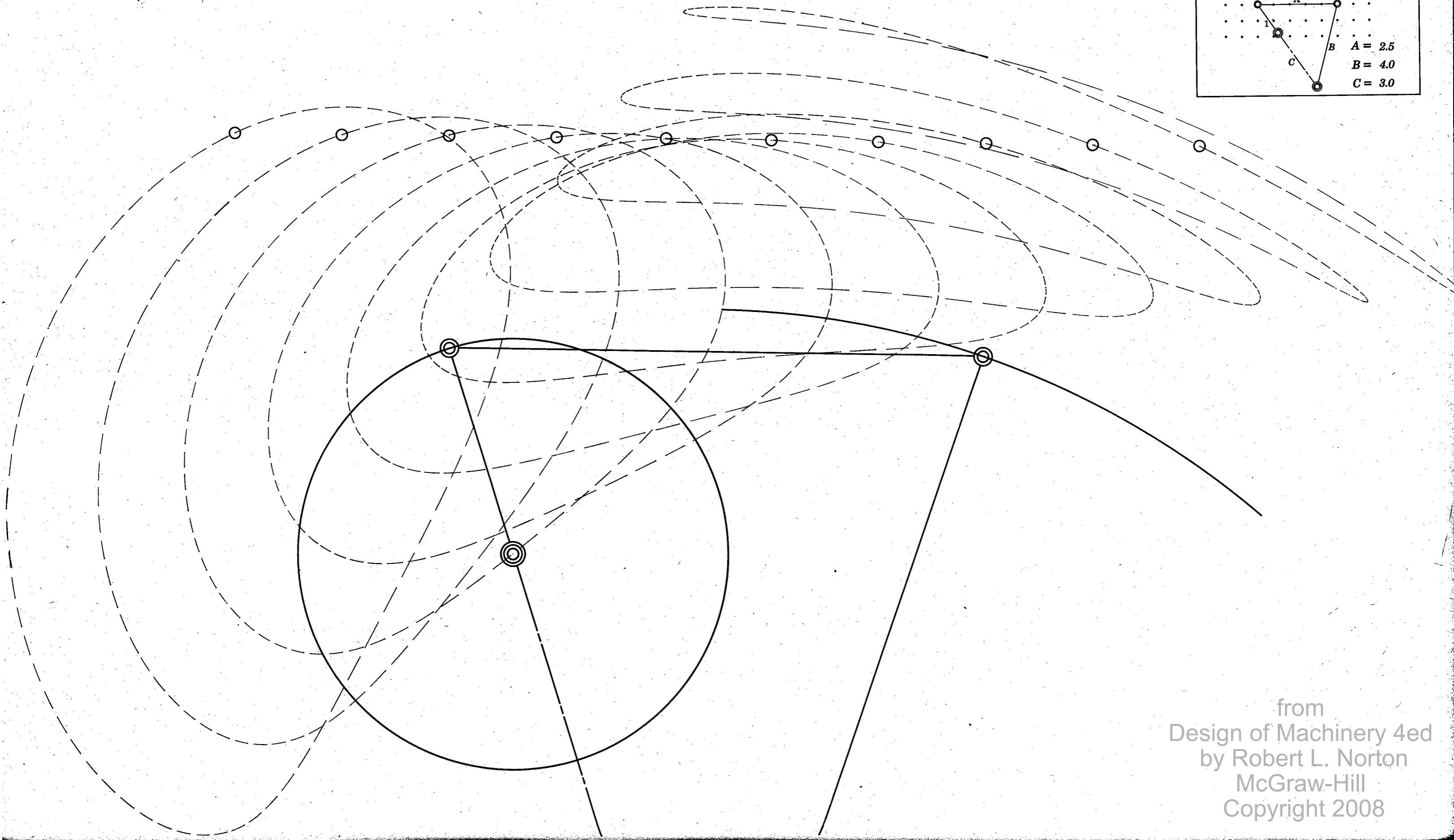
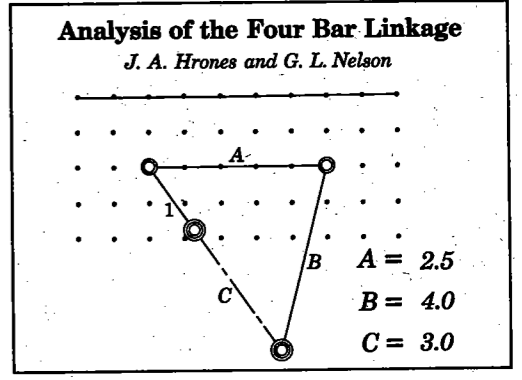

from  
Design of Machinery 4ed  
by Robert L. Norton  
McGraw-Hill  
Copyright 2008

**Analysis of the Four Bar Linkage**

*J. A. Hrones and G. L. Nelson*

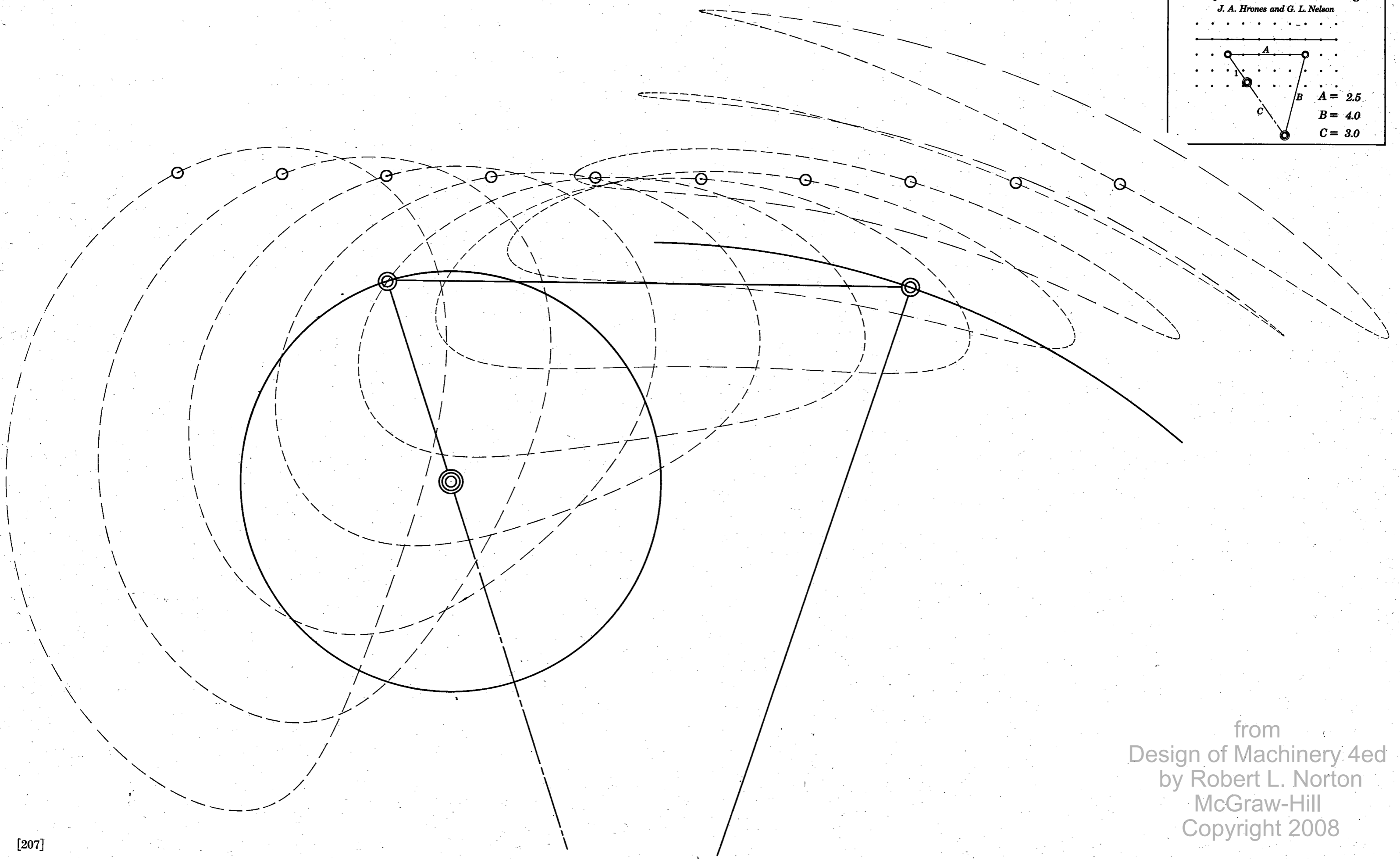
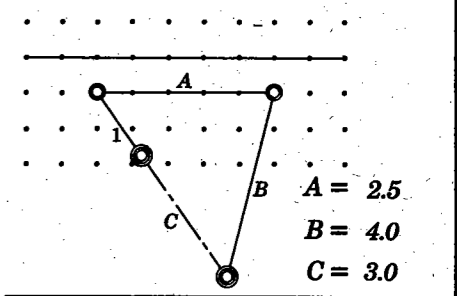

from  
Design of Machinery, 4ed  
by Robert L. Norton  
McGraw-Hill  
Copyright 2008

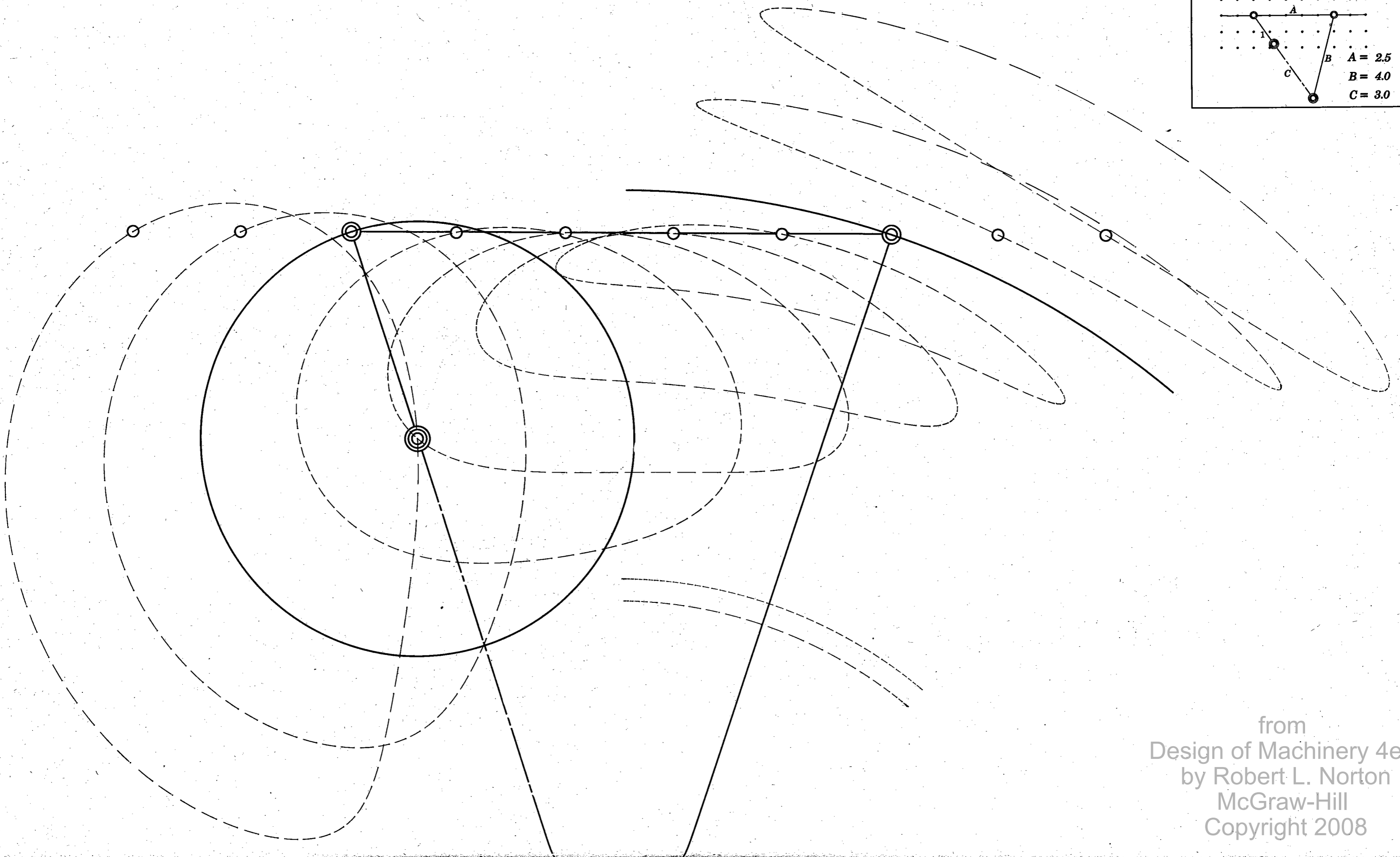
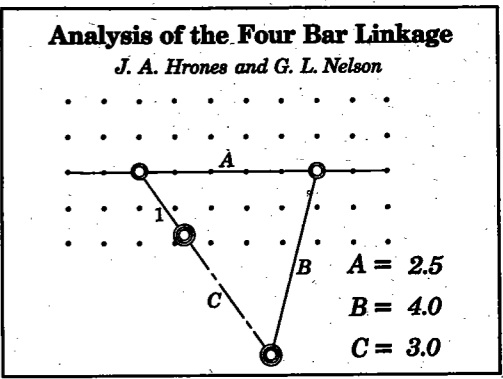

from  
Design of Machinery 4ed  
by Robert L. Norton  
McGraw-Hill  
Copyright 2008

**Analysis of the Four Bar Linkage**  
*J. A. Hrones and G. L. Nelson*

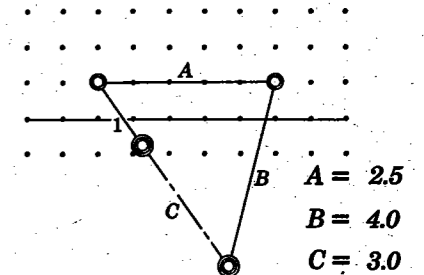

$A = 2.5$   
 $B = 4.0$   
 $C = 3.0$

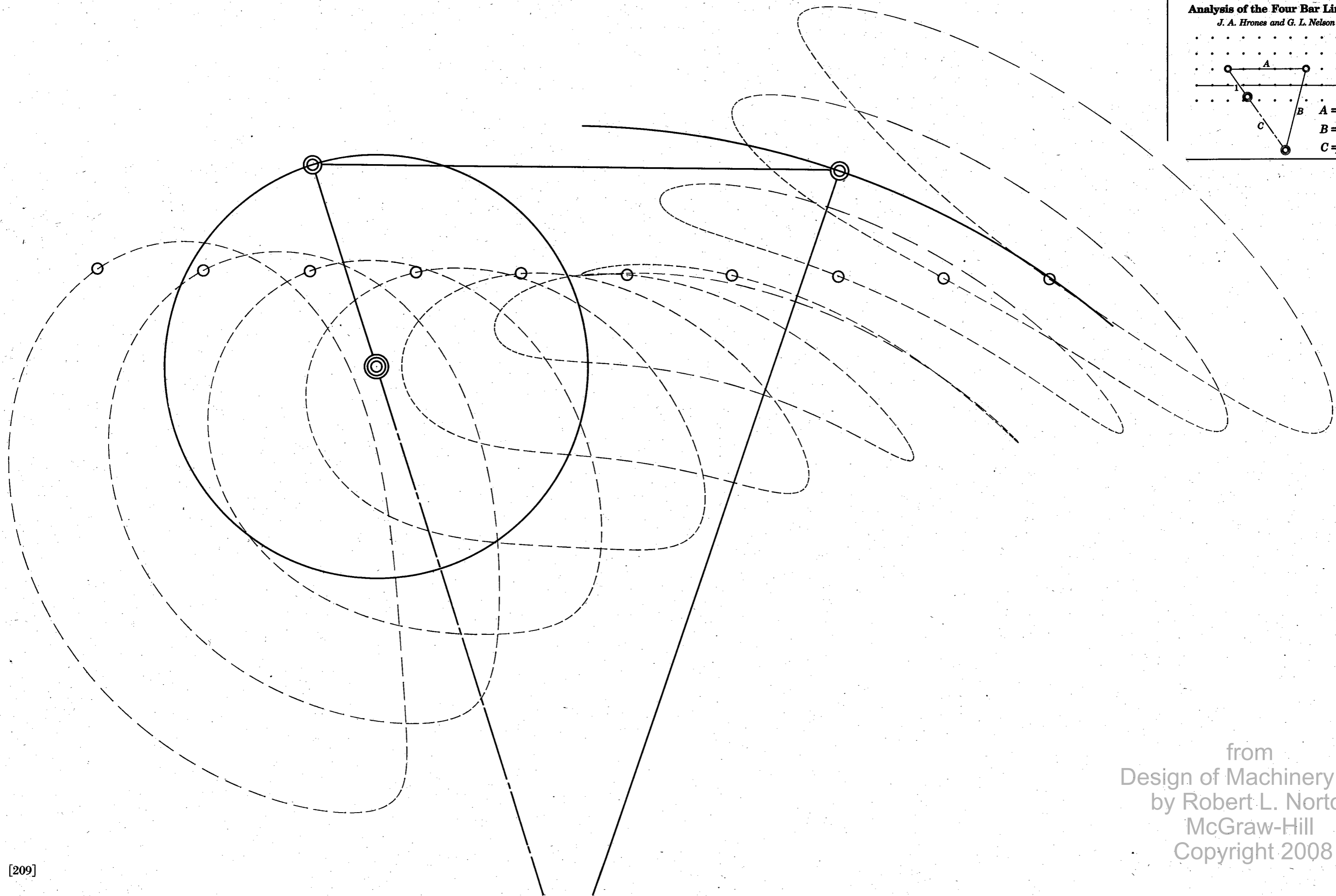

from  
 Design of Machinery 4ed  
 by Robert L. Norton  
 McGraw-Hill  
 Copyright 2008



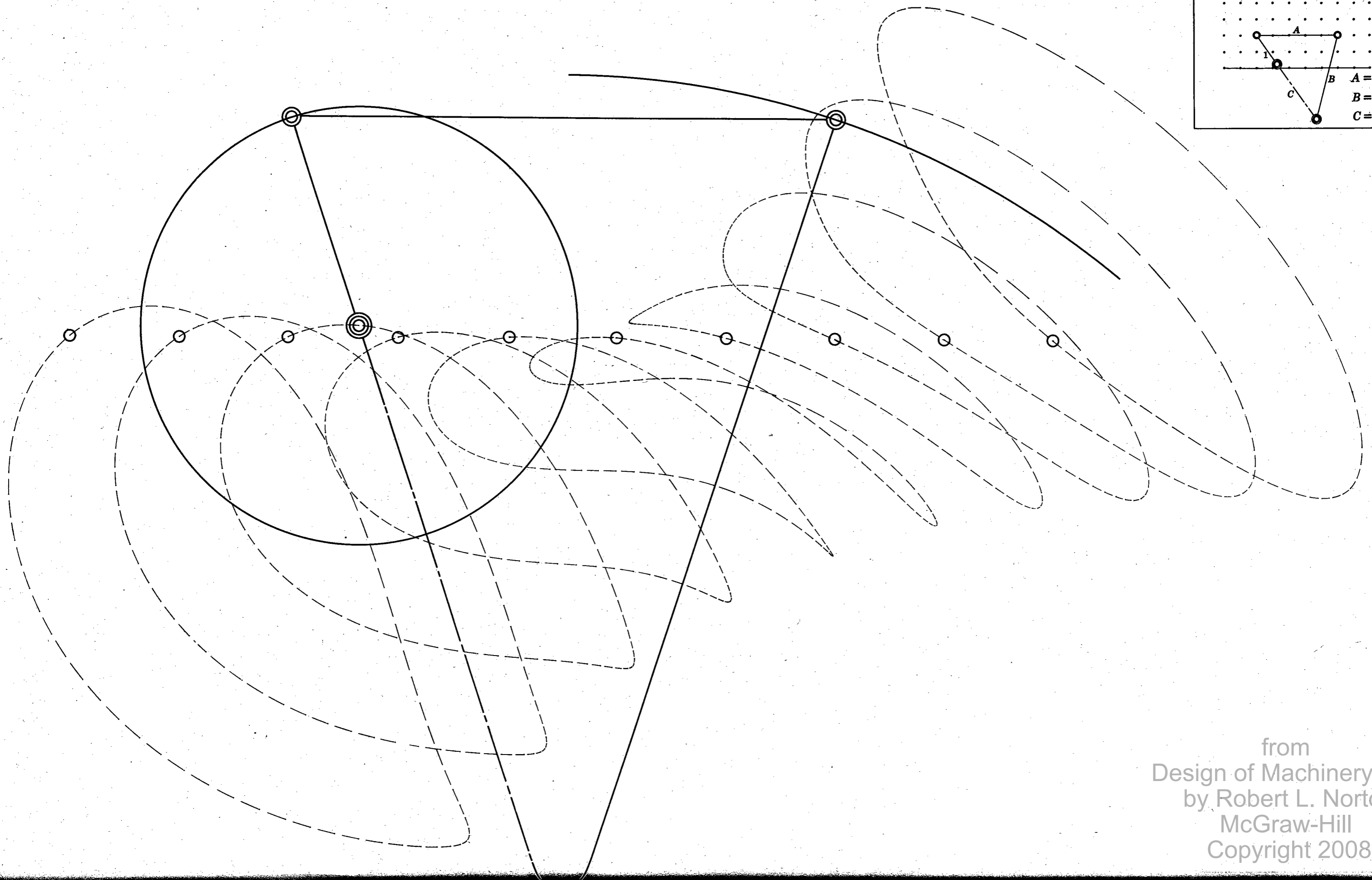
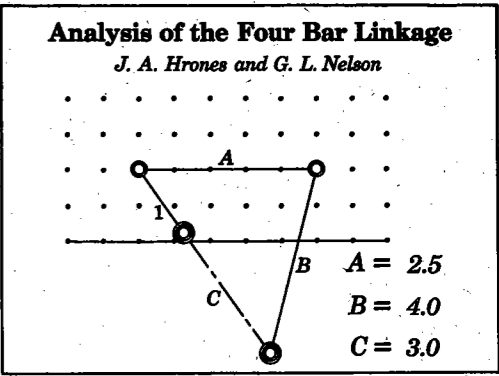

from  
Design of Machinery 4ed  
by Robert L. Norton  
McGraw-Hill  
Copyright 2008

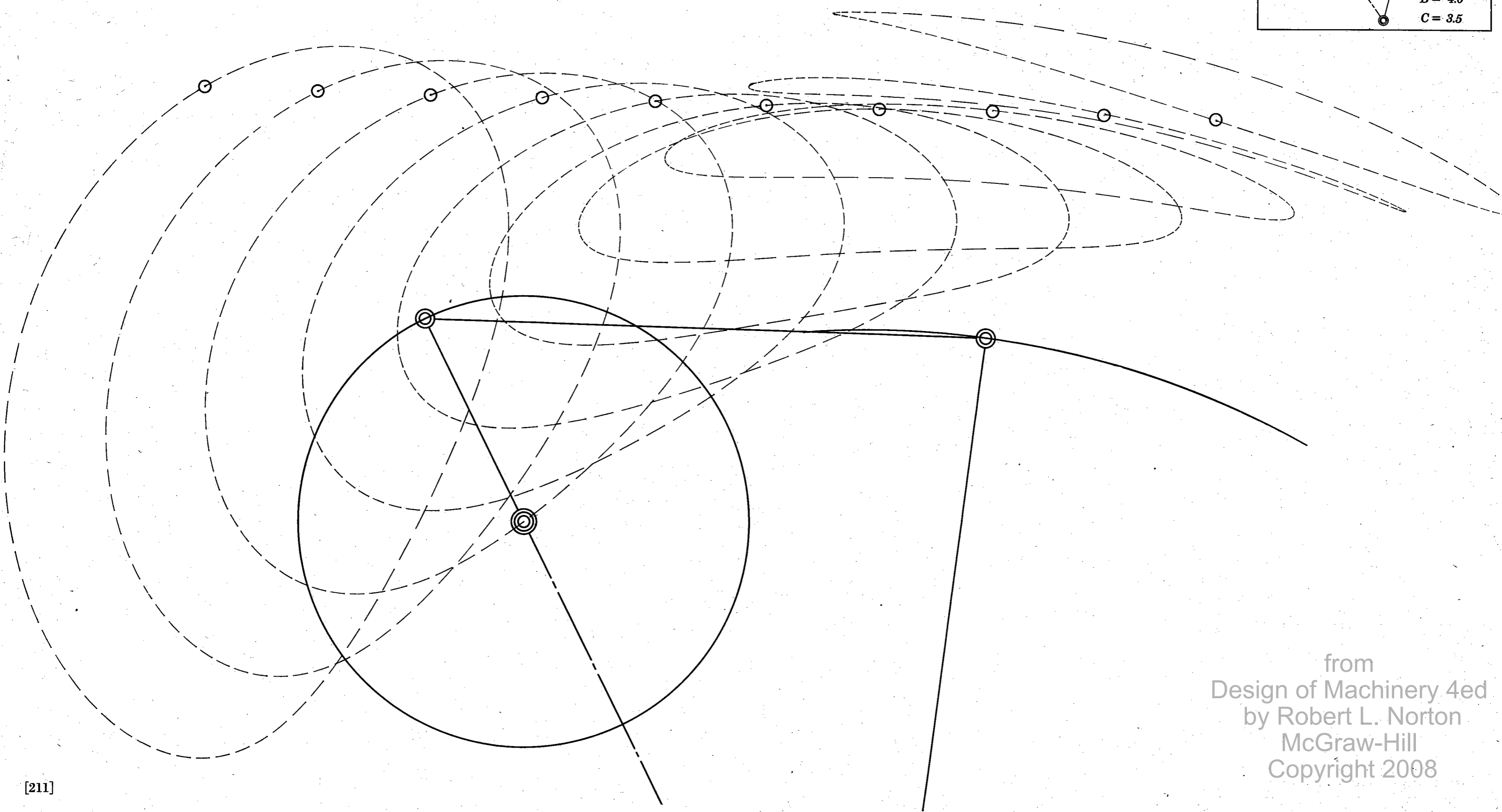
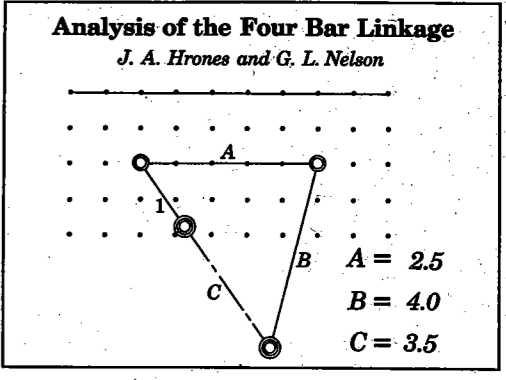

from  
 Design of Machinery 4ed  
 by Robert L. Norton  
 McGraw-Hill  
 Copyright 2008

**Analysis of the Four Bar Linkage**  
*J. A. Hrones and G. L. Nelson*

.....

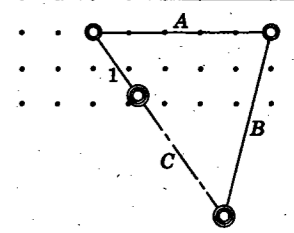

$A = 2.5$   
 $B = 4.0$   
 $C = 3.5$

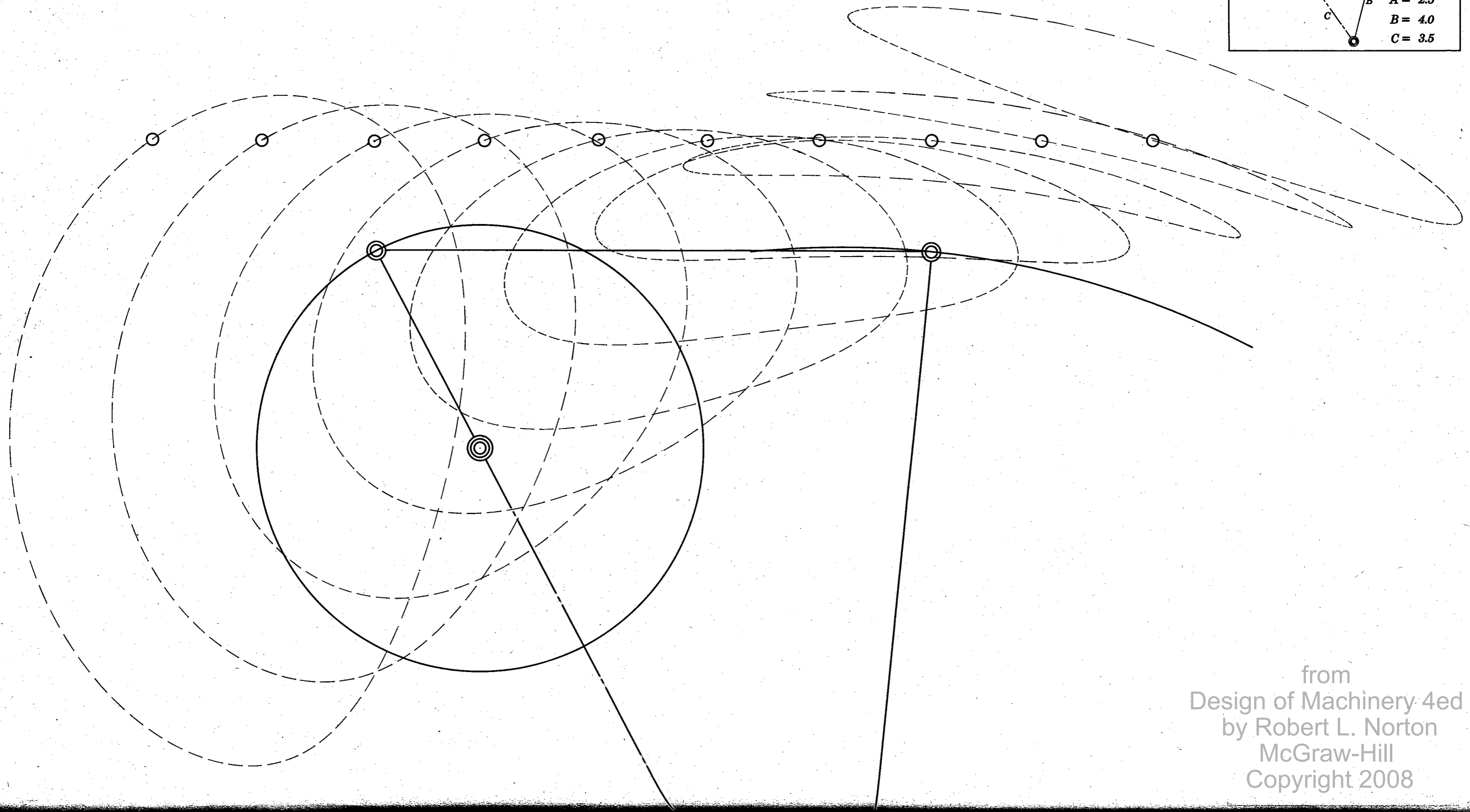

from  
Design of Machinery 4ed  
by Robert L. Norton  
McGraw-Hill  
Copyright 2008

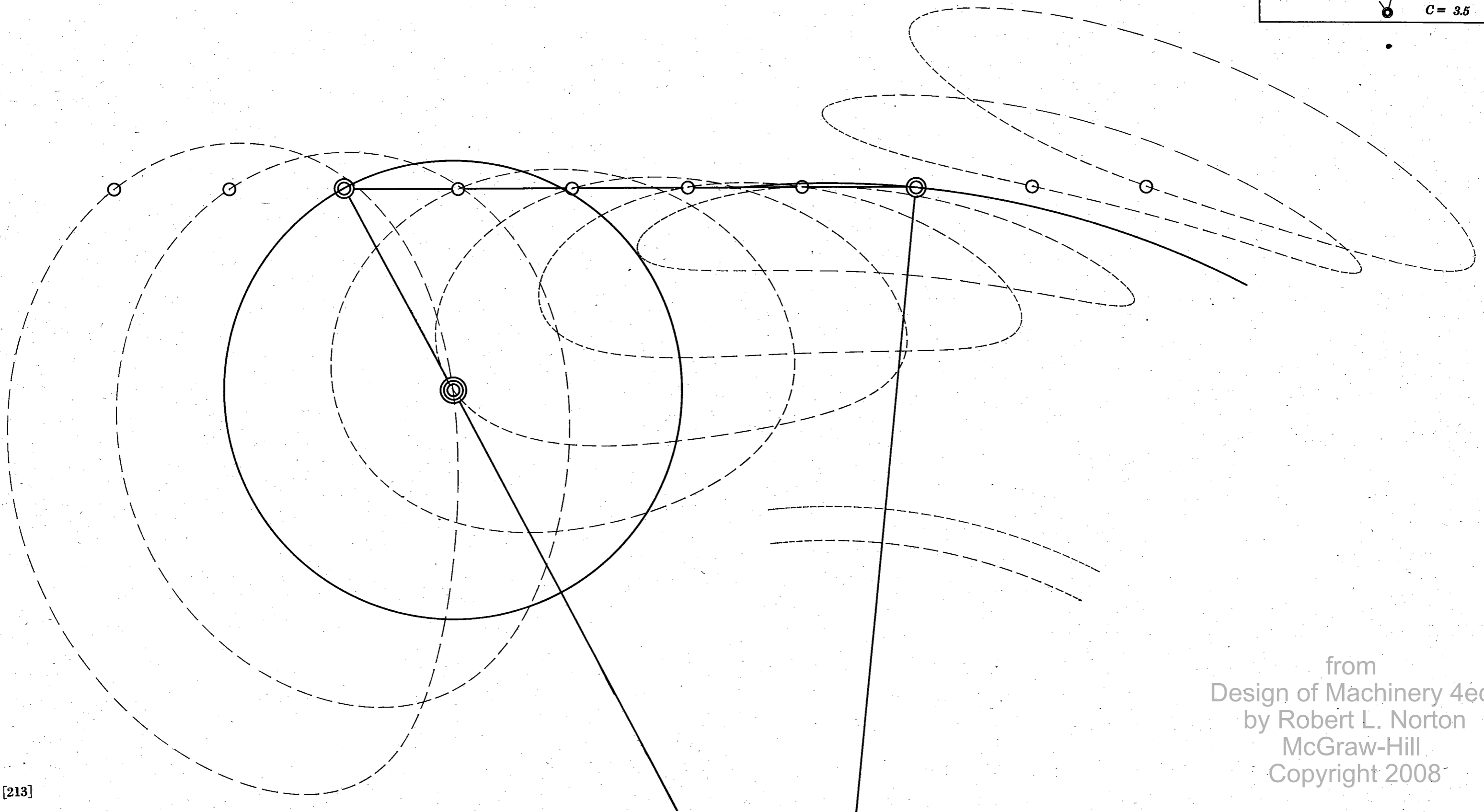
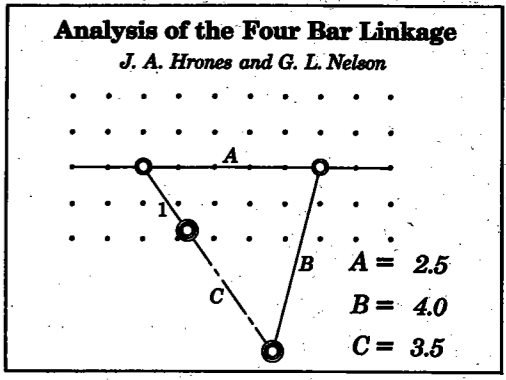

from  
 Design of Machinery 4ed  
 by Robert L. Norton  
 McGraw-Hill  
 Copyright 2008

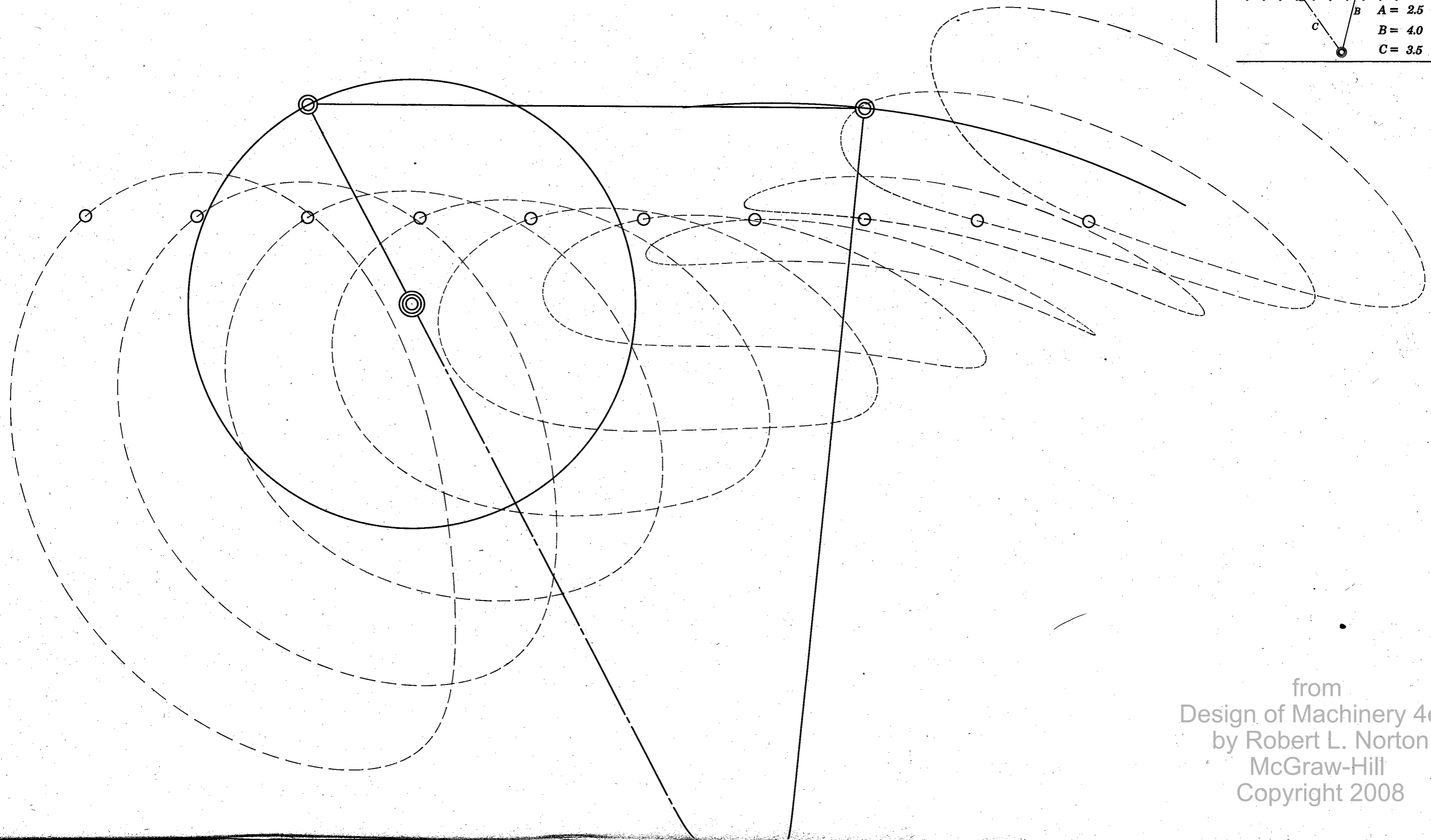
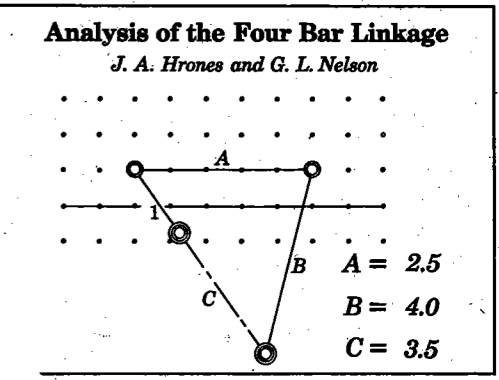

from  
Design of Machinery 4ed  
by Robert L. Norton  
McGraw-Hill  
Copyright 2008

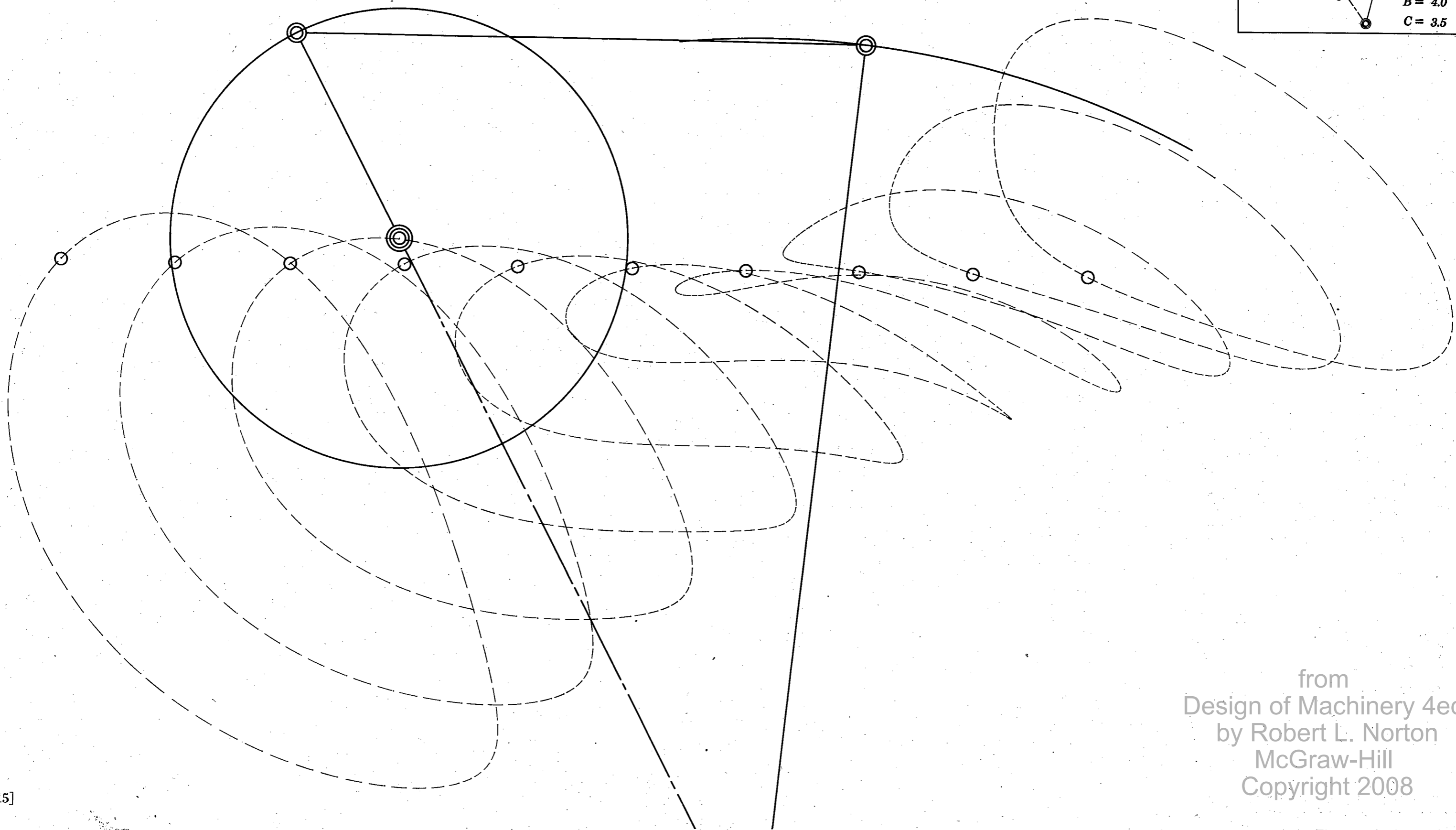
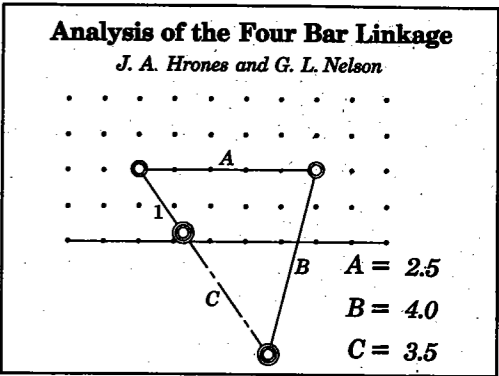

from  
 Design of Machinery 4ed  
 by Robert L. Norton  
 McGraw-Hill  
 Copyright 2008

**Analysis of the Four Bar Linkage**  
*J. A. Hrones and G. L. Nelson*

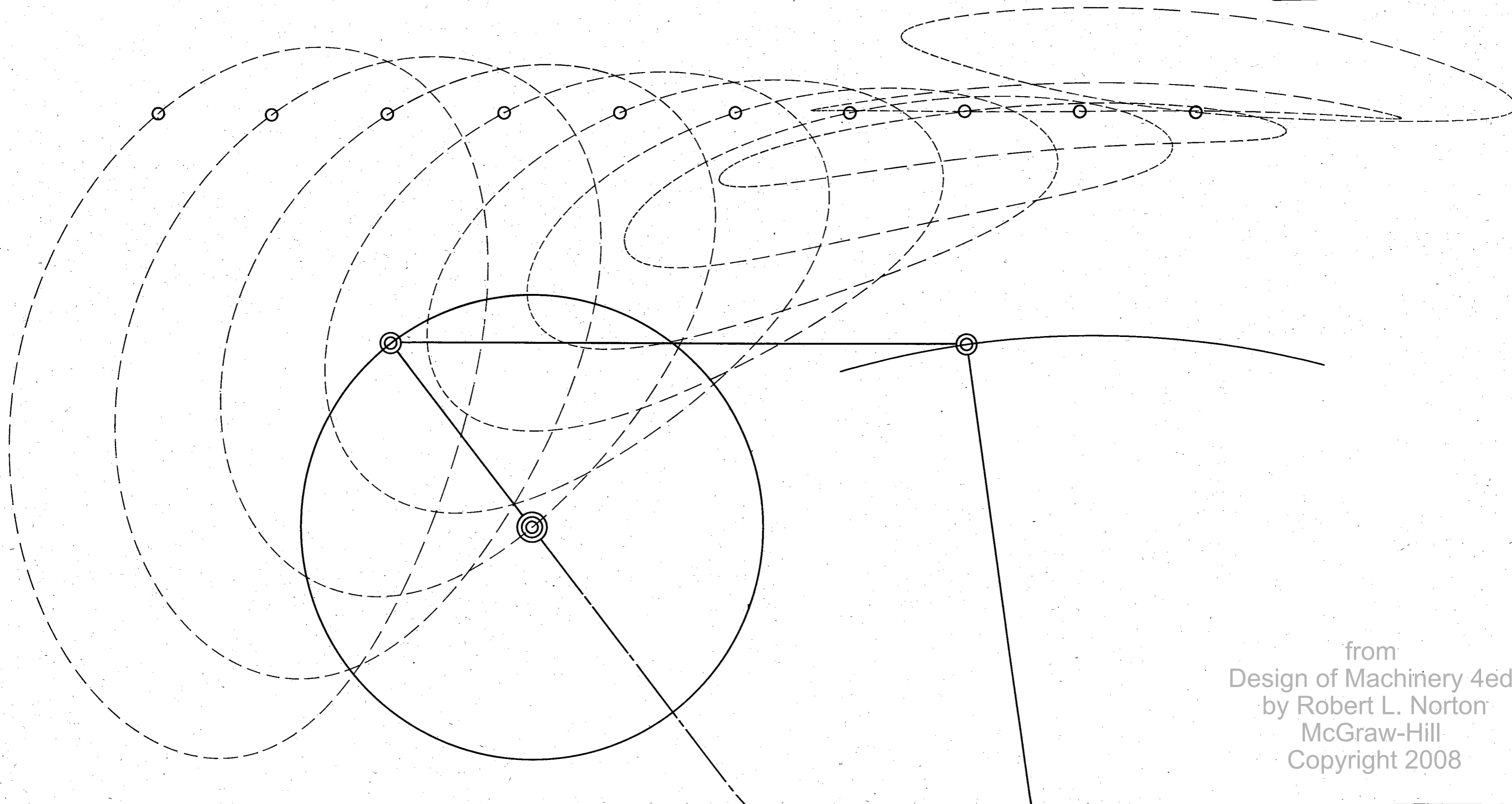
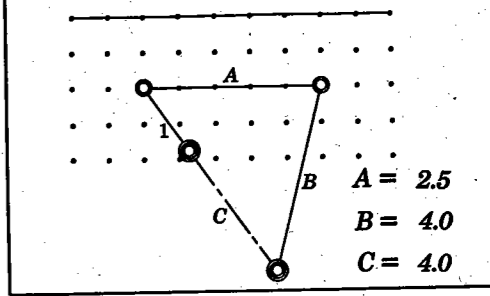

from  
Design of Machinery 4ed  
by Robert L. Norton  
McGraw-Hill  
Copyright 2008

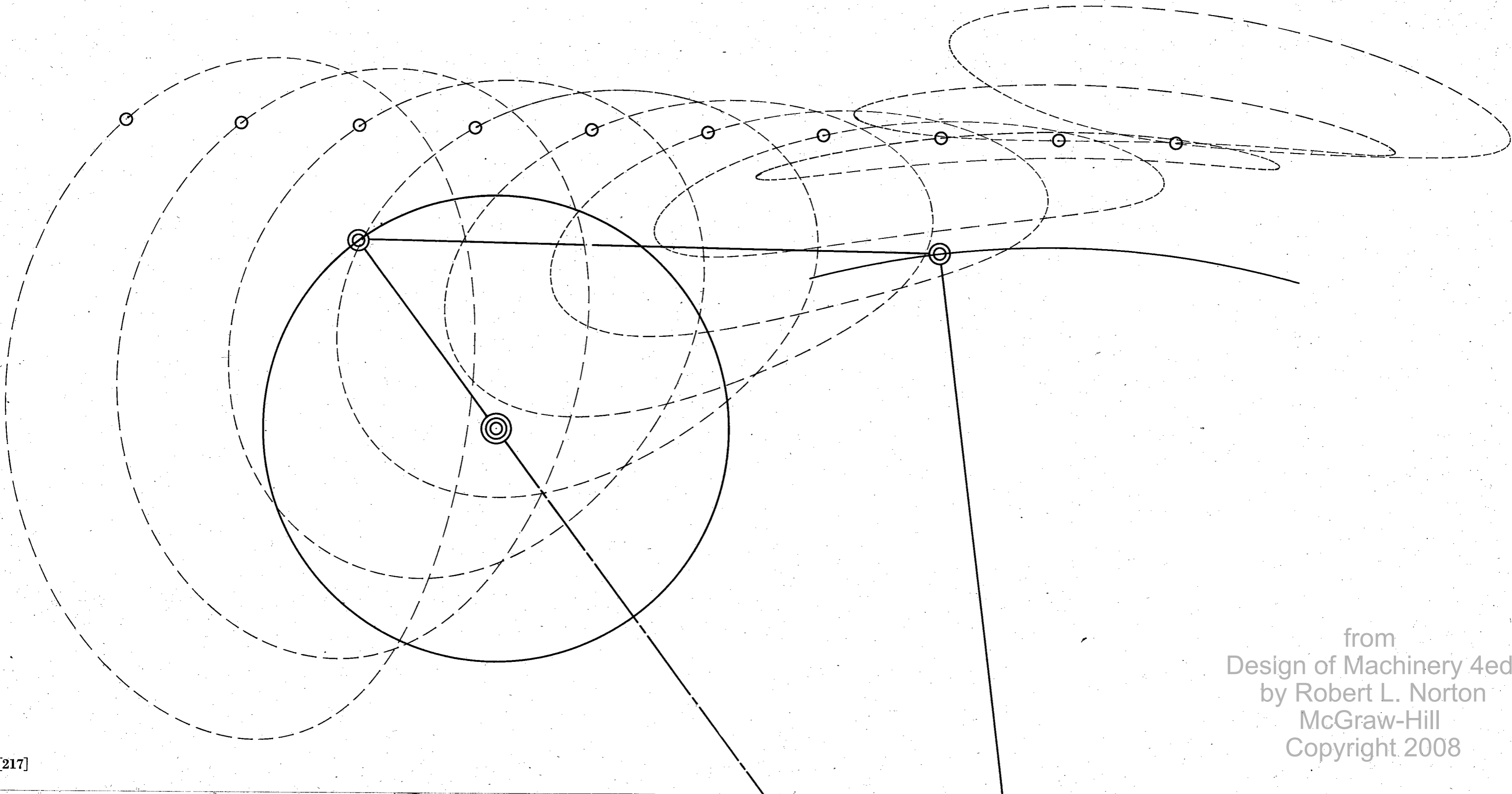
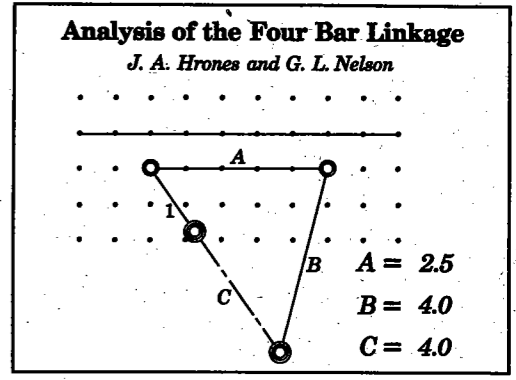

from  
 Design of Machinery 4ed  
 by Robert L. Norton  
 McGraw-Hill  
 Copyright 2008



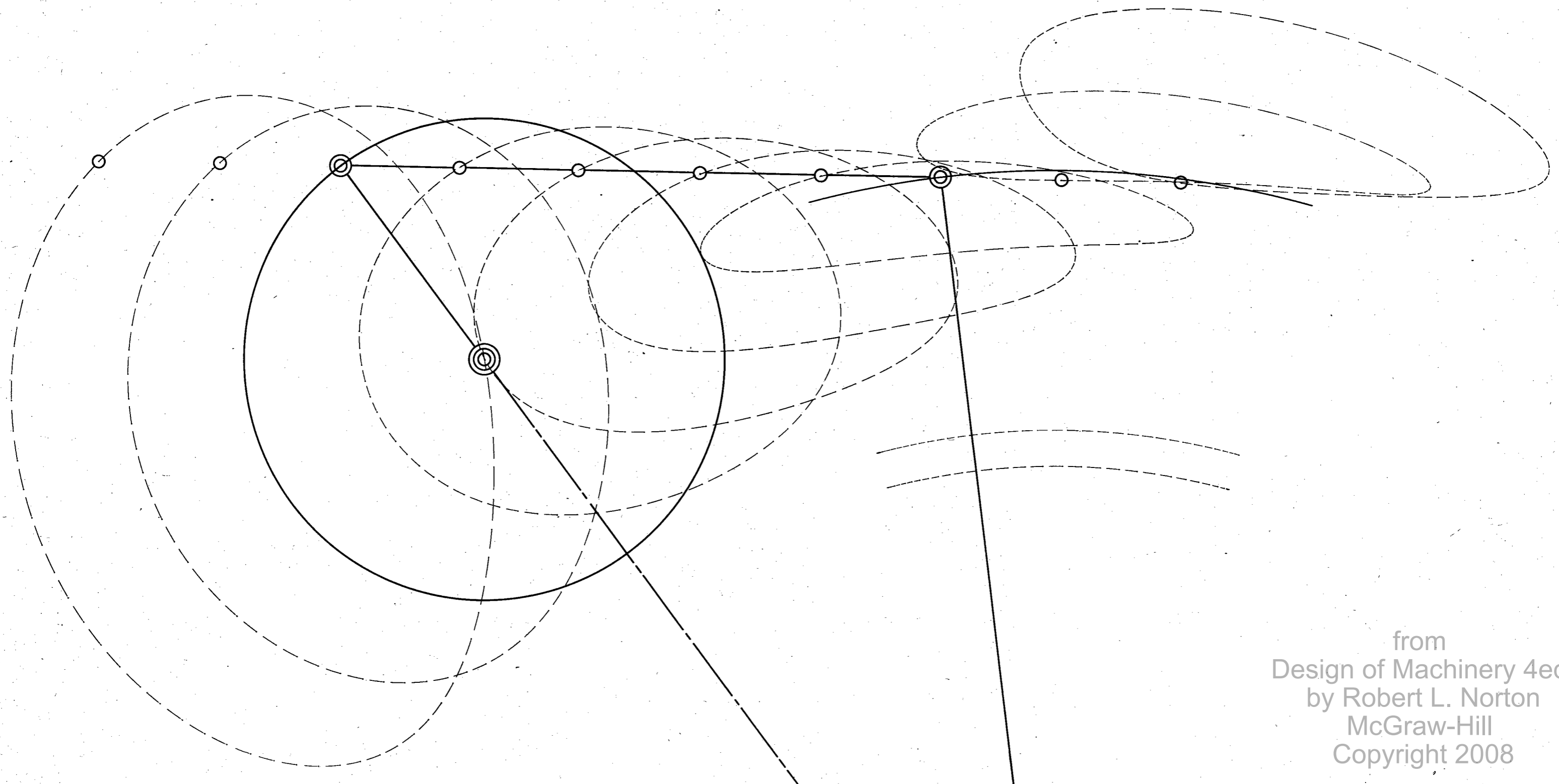
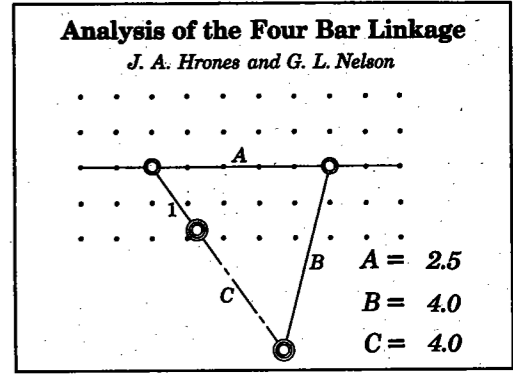

from  
Design of Machinery 4ed  
by Robert L. Norton  
McGraw-Hill  
Copyright 2008

**Analysis of the Four Bar Linkage**

*J. A. Hrones and G. L. Nelson*

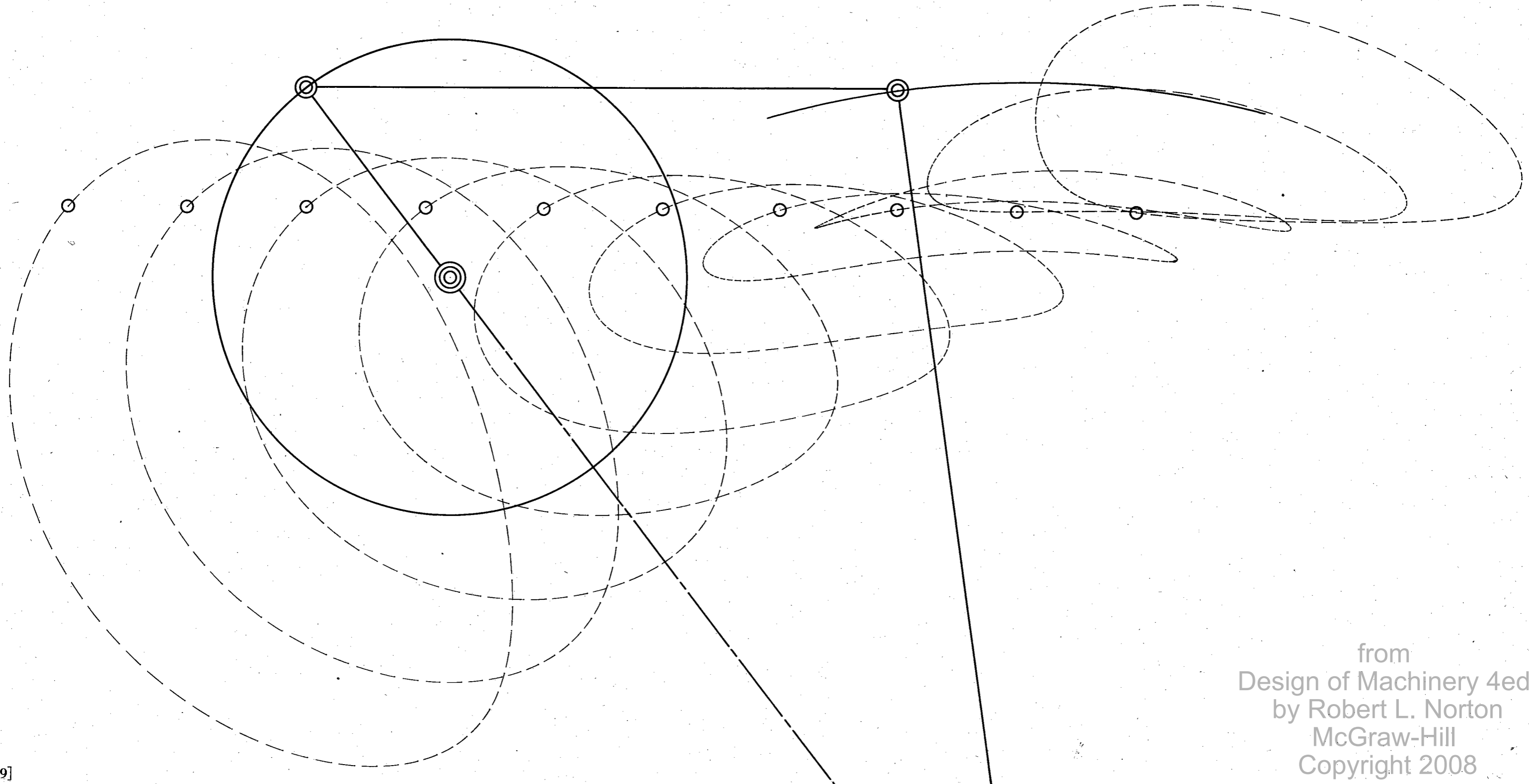
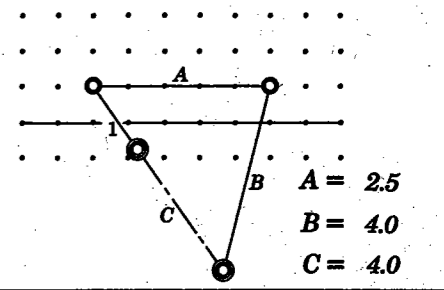

from  
Design of Machinery 4ed  
by Robert L. Norton  
McGraw-Hill  
Copyright 2008

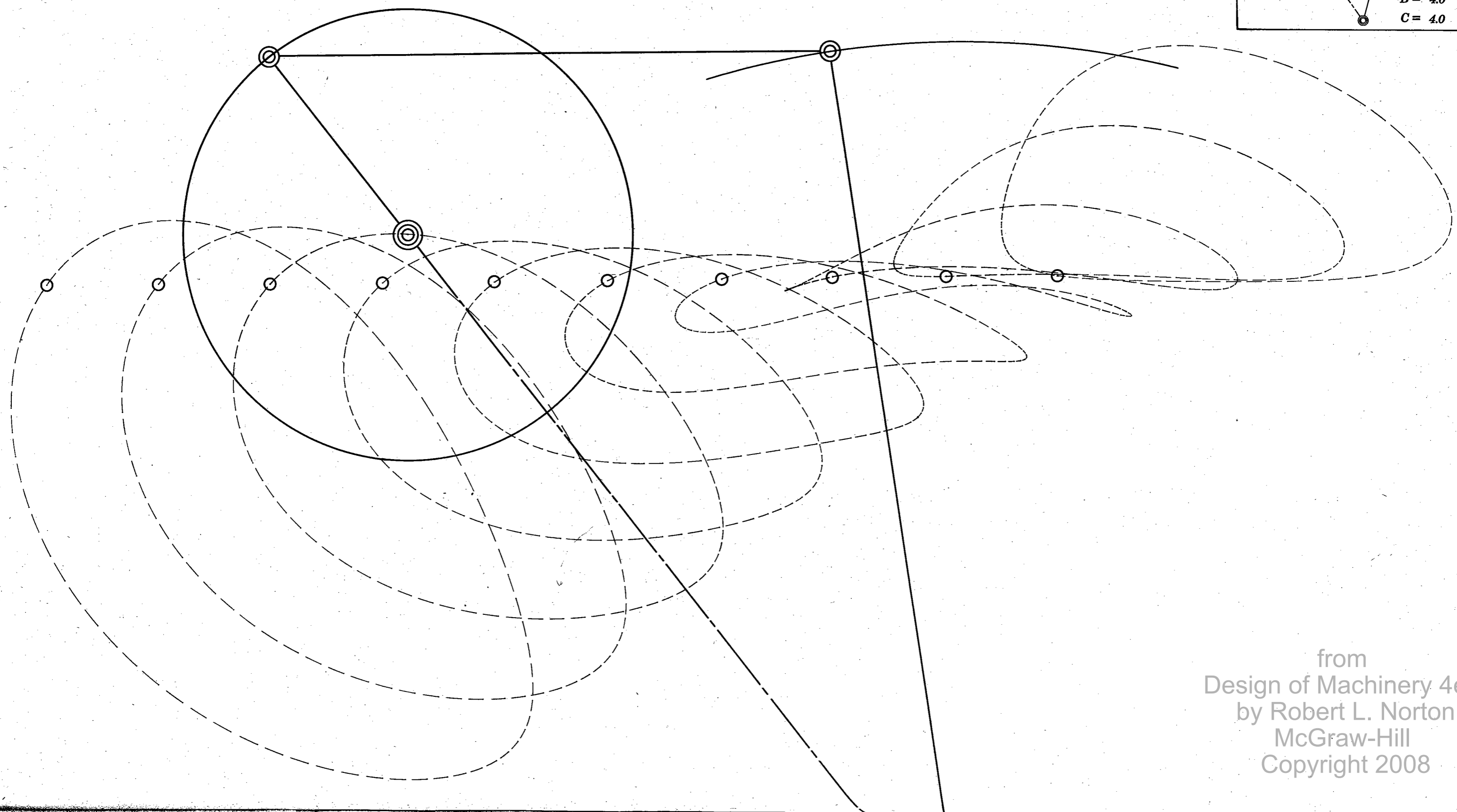
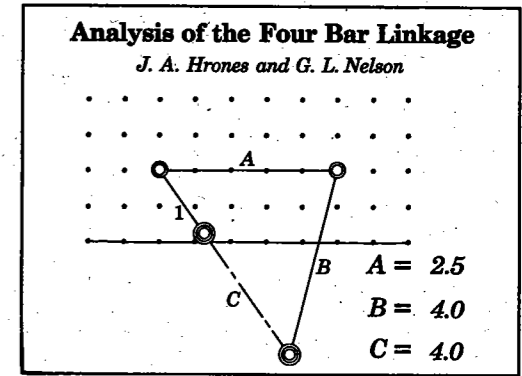

from  
Design of Machinery 4ed  
by Robert L. Norton  
McGraw-Hill  
Copyright 2008

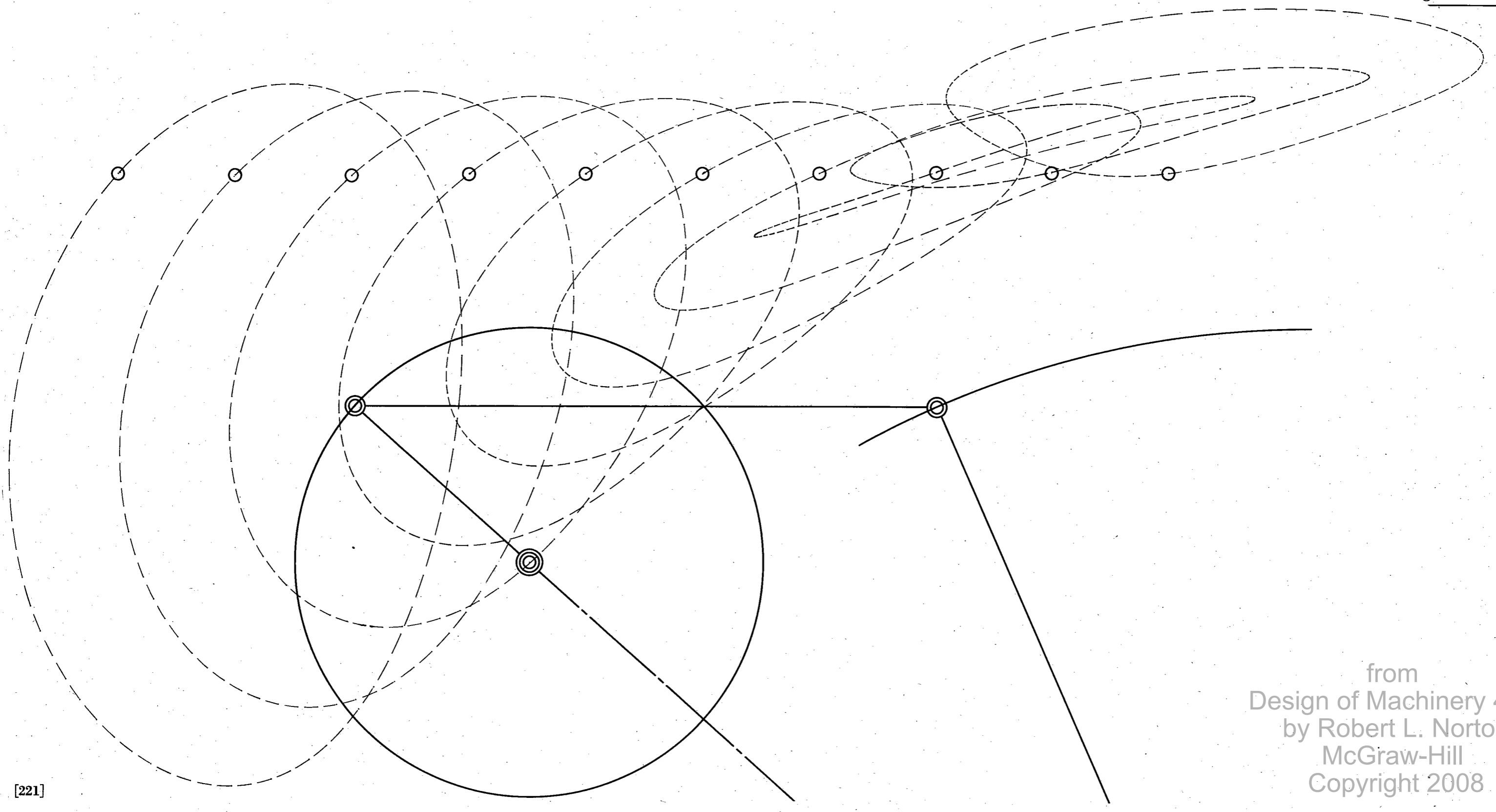
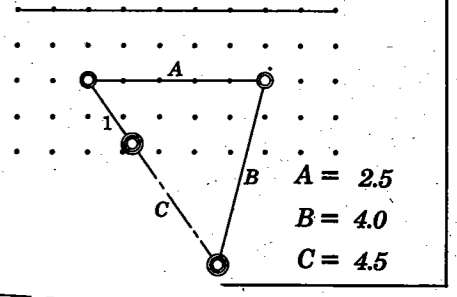

from  
Design of Machinery 4ed.  
by Robert L. Norton  
McGraw-Hill  
Copyright 2008

**Analysis of the Four Bar Linkage**  
*J. A. Hrones and G. L. Nelson*

$A = 2.5$   
 $B = 4.0$   
 $C = 4.5$

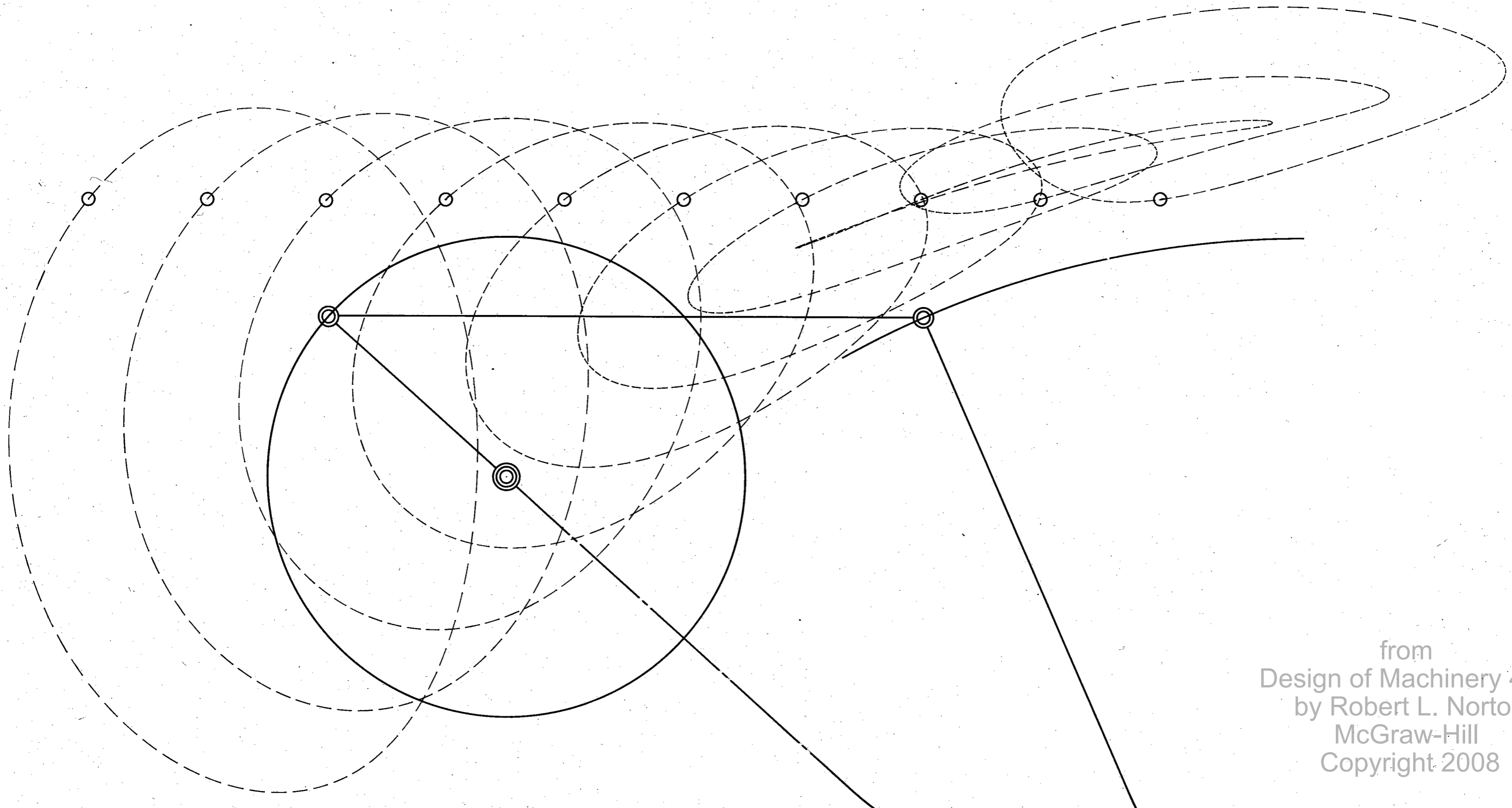

from  
Design of Machinery 4ed  
by Robert L. Norton  
McGraw-Hill  
Copyright 2008

**Analysis of the Four Bar Linkage**

*J. A. Hrones and G. L. Nelson*

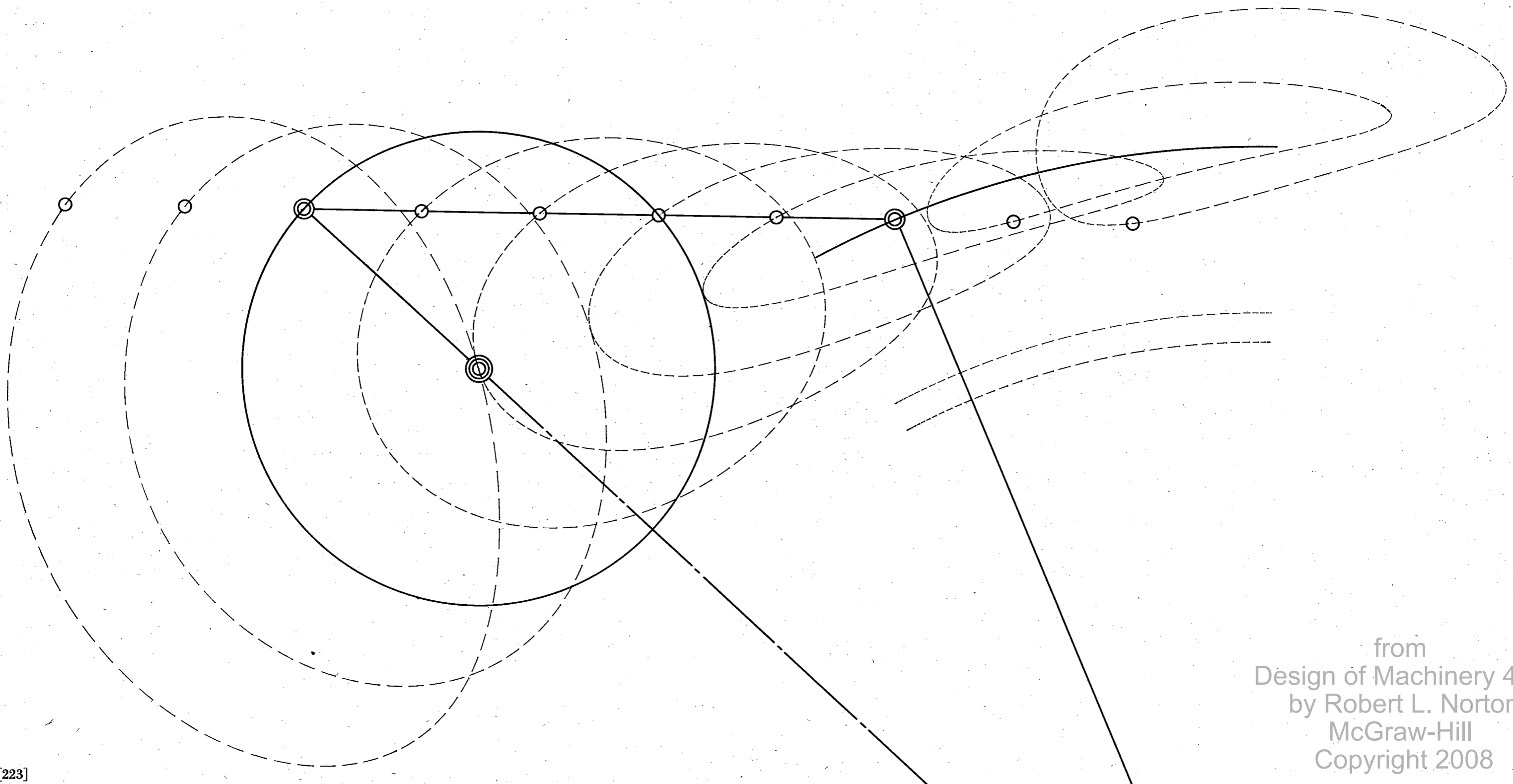
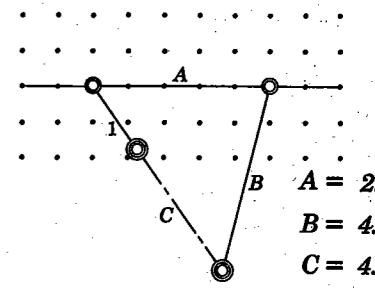

from  
Design of Machinery 4ed  
by Robert L. Norton  
McGraw-Hill  
Copyright 2008

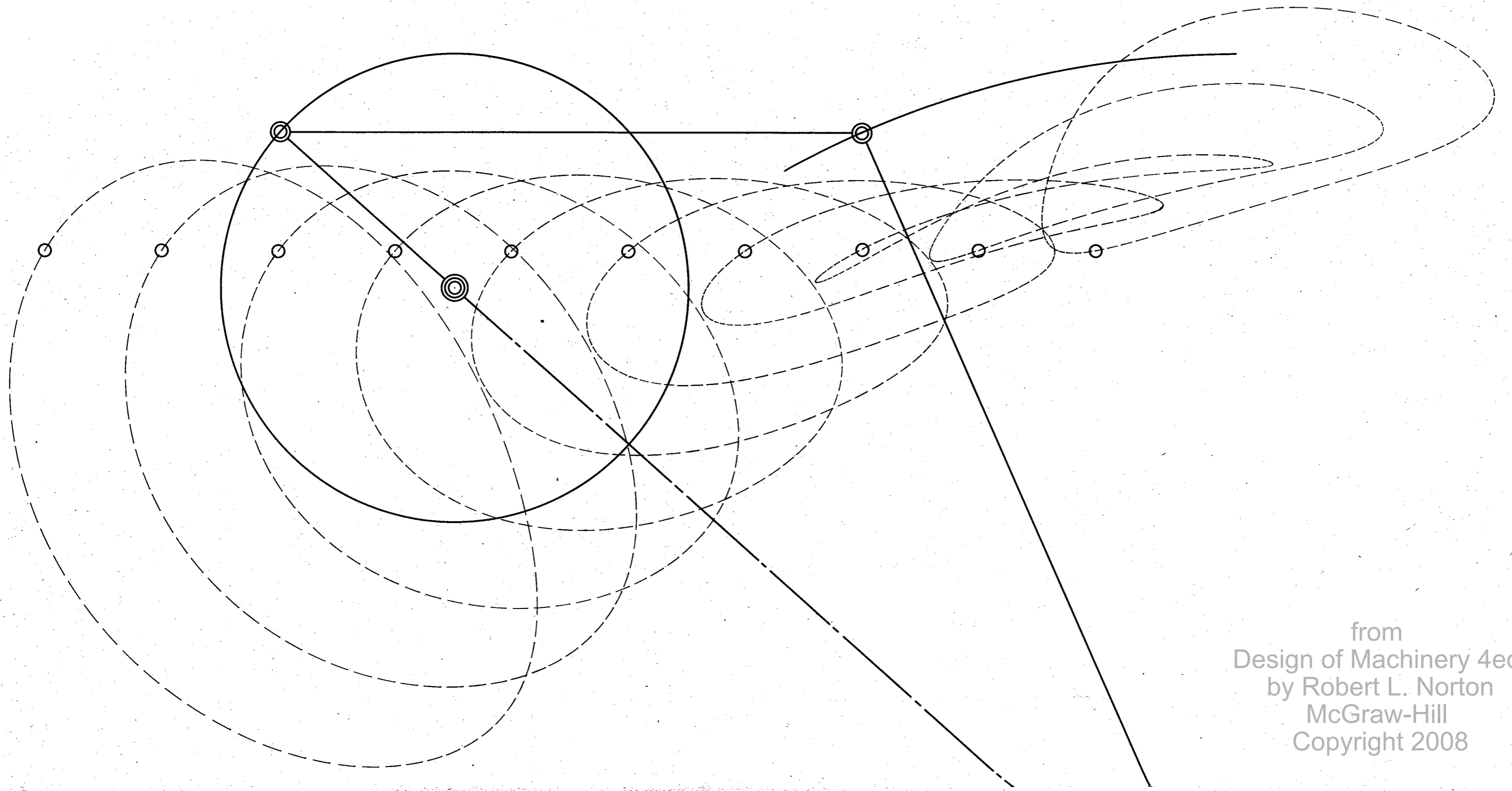
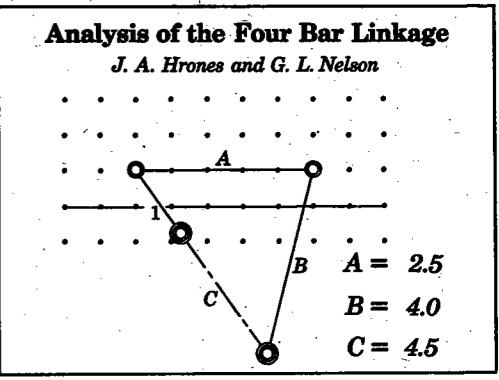

from  
Design of Machinery 4ed  
by Robert L. Norton  
McGraw-Hill  
Copyright 2008

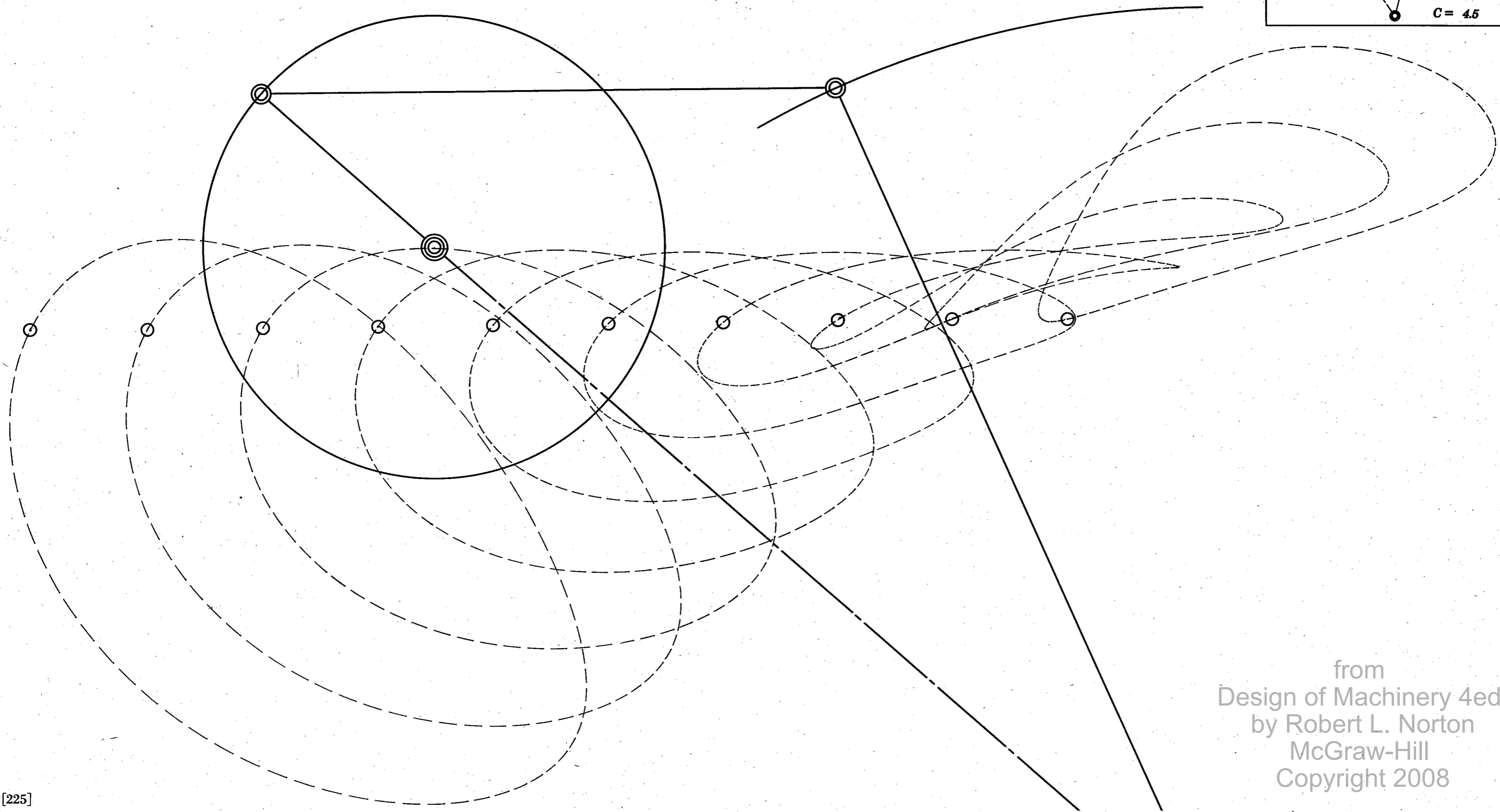
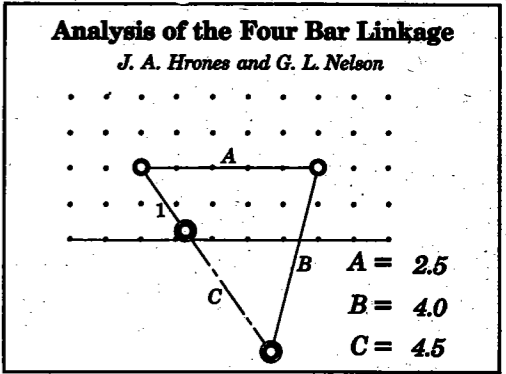

from  
 Design of Machinery 4ed  
 by Robert L. Norton  
 McGraw-Hill  
 Copyright 2008



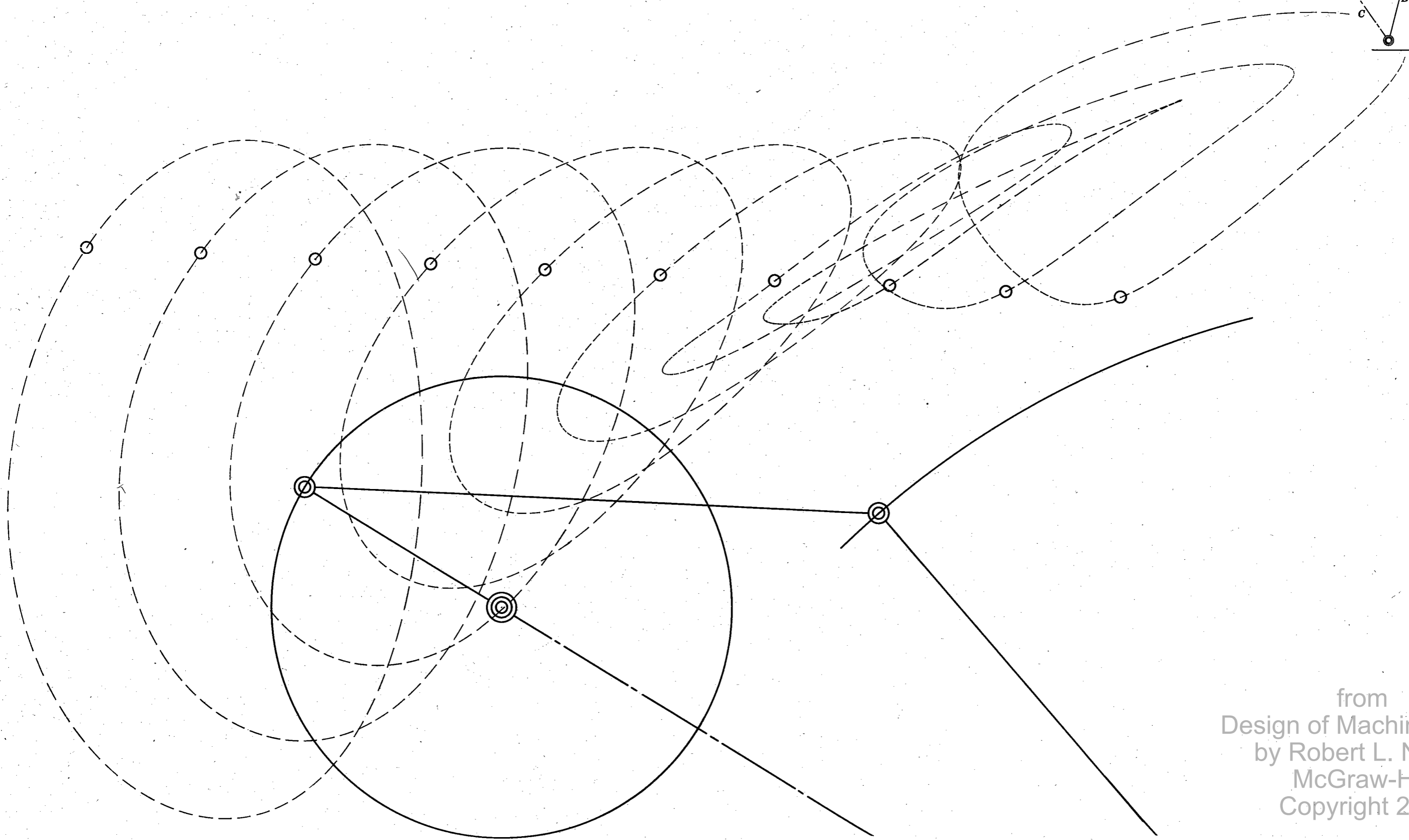
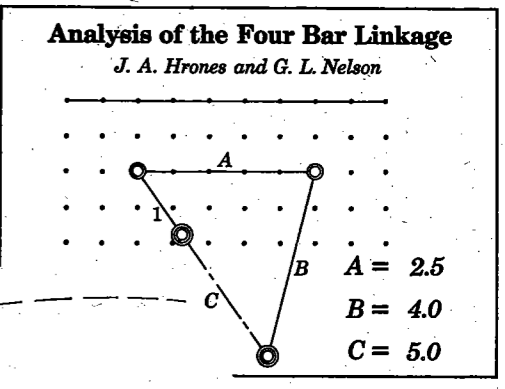

from  
Design of Machinery 4ed  
by Robert L. Norton  
McGraw-Hill  
Copyright 2008

**Analysis of the Four Bar Linkage**

*J. A. Hrones and G. L. Nelson*

.....

.....

.....

.....

.....

.....

.....

.....

.....

.....

.....

.....

.....

.....

.....

.....

.....

.....

.....

.....

.....

.....

.....

.....

.....

.....

.....

.....

.....

.....

.....

.....

.....

.....

.....

.....

.....

.....

.....

.....

.....

.....

.....

.....

.....

.....

.....

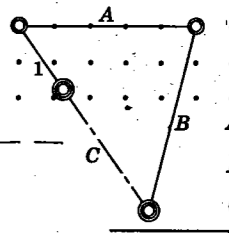

**A = 2.5**  
**B = 4.0**  
**C = 5.0**

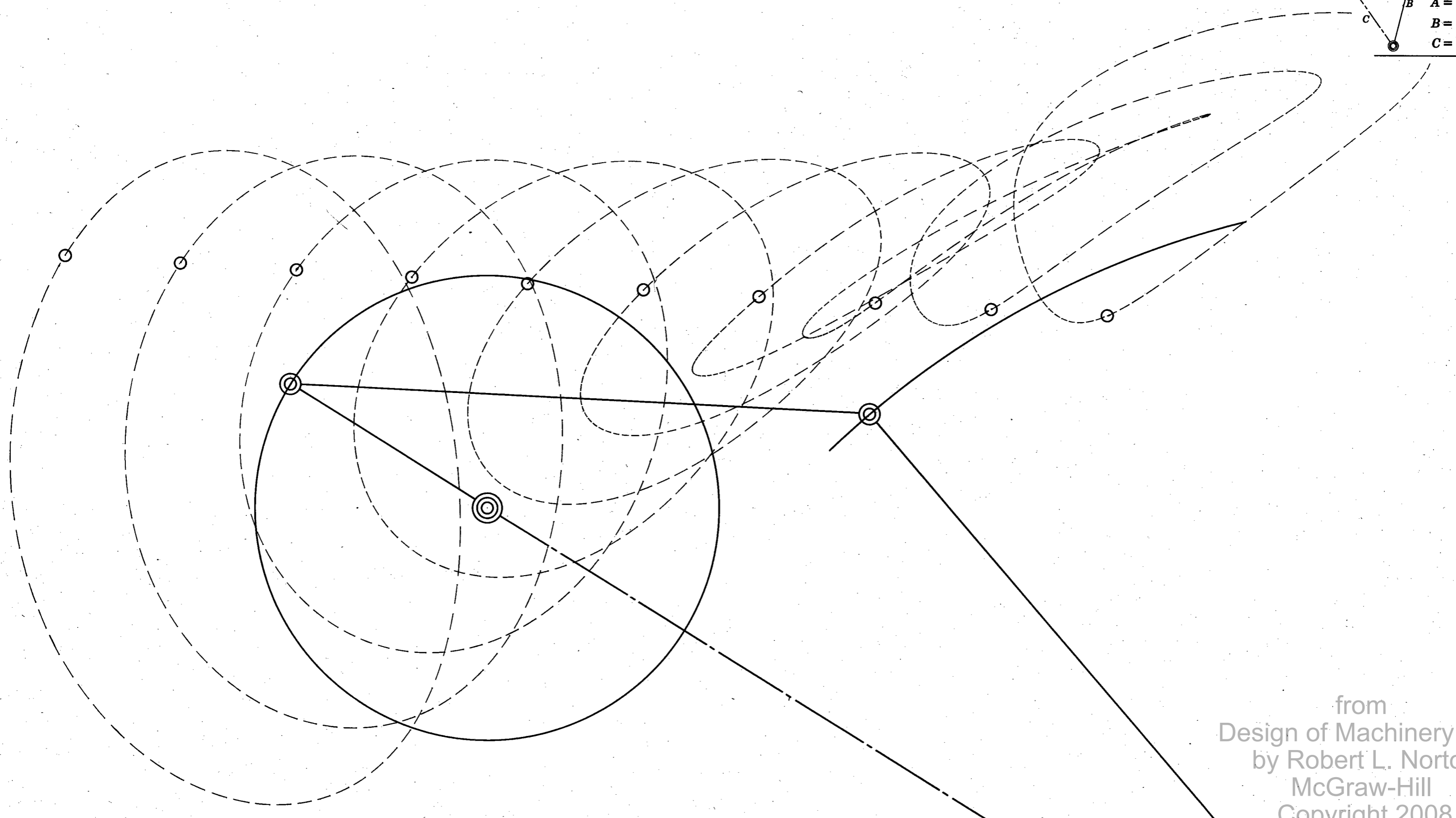

from  
Design of Machinery 4ed  
by Robert L. Norton  
McGraw-Hill  
Copyright 2008

**Analysis of the Four Bar Linkage**  
*J. A. Hrones and G. L. Nelson*

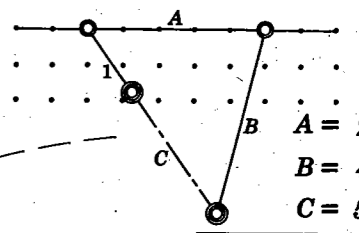

$A = 2.5$   
 $B = 4.0$   
 $C = 5.0$

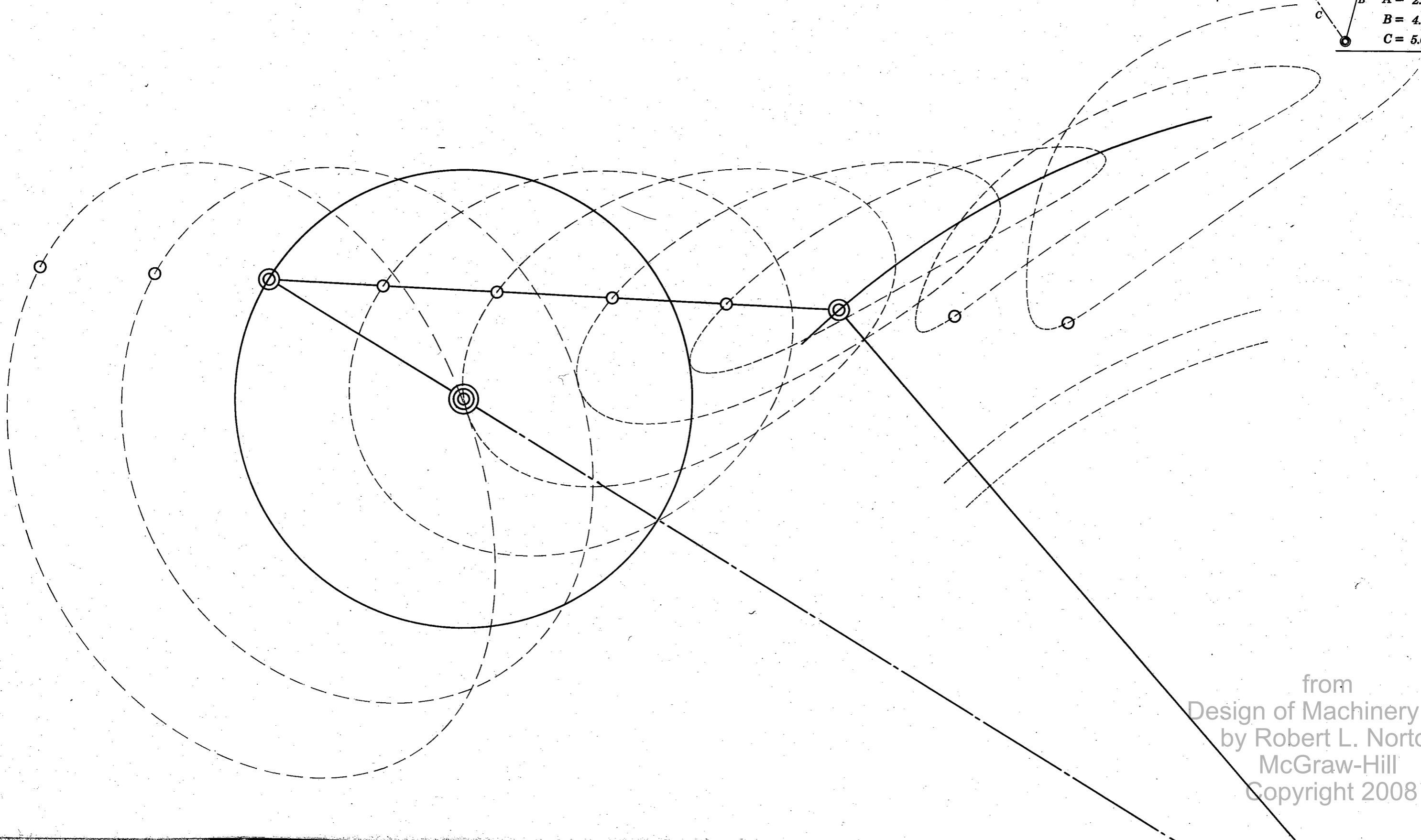

from  
Design of Machinery 4ed  
by Robert L. Norton  
McGraw-Hill  
Copyright 2008

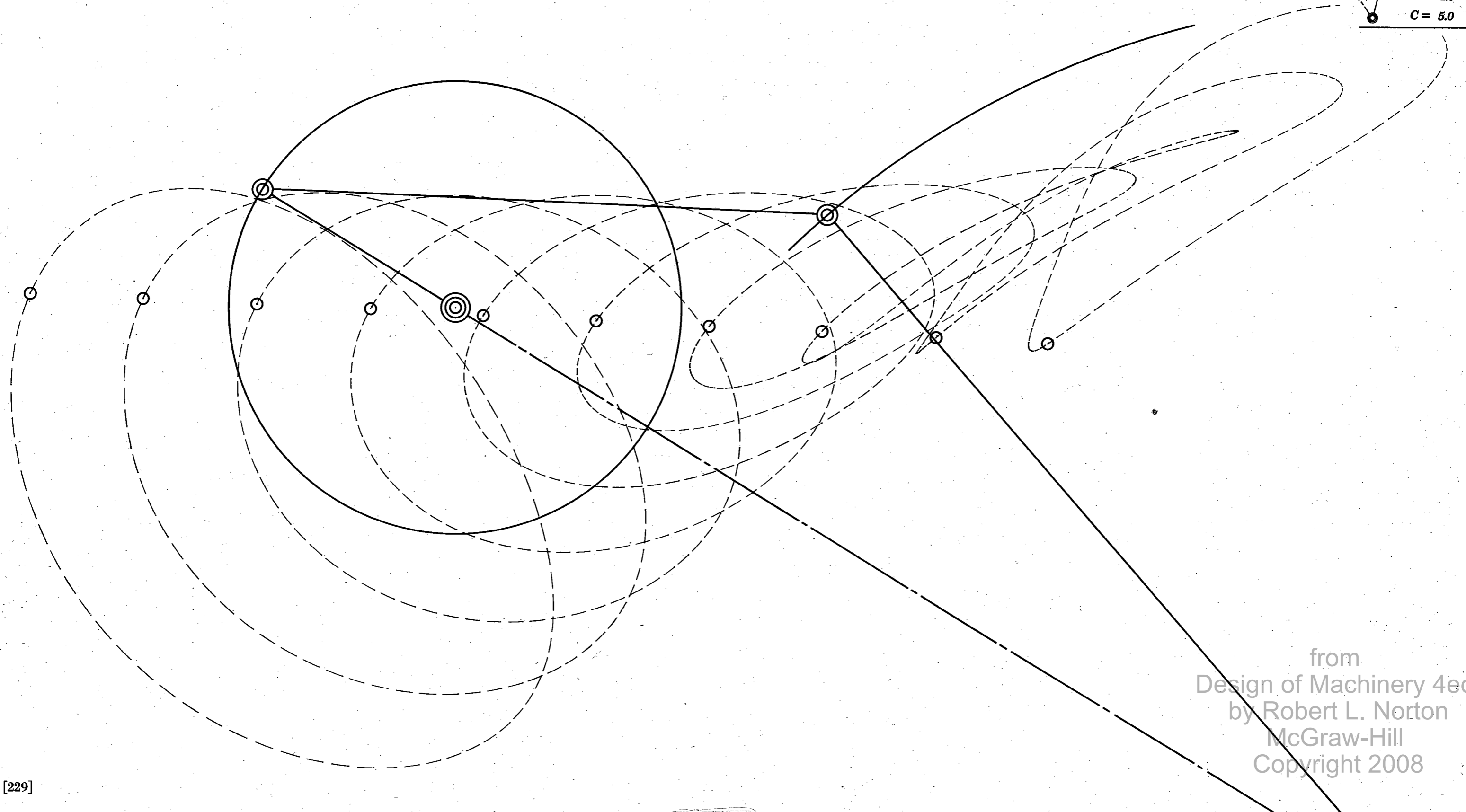
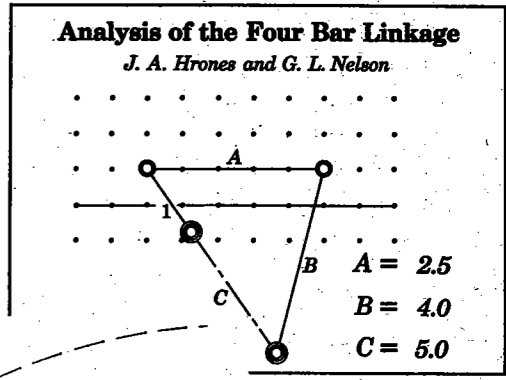

from  
 Design of Machinery 4ed  
 by Robert L. Norton  
 McGraw-Hill  
 Copyright 2008

**Analysis of the Four Bar Linkage**  
*J. A. Hrones and G. L. Nelson*

A = 2.5  
B = 4.0  
C = 5.0

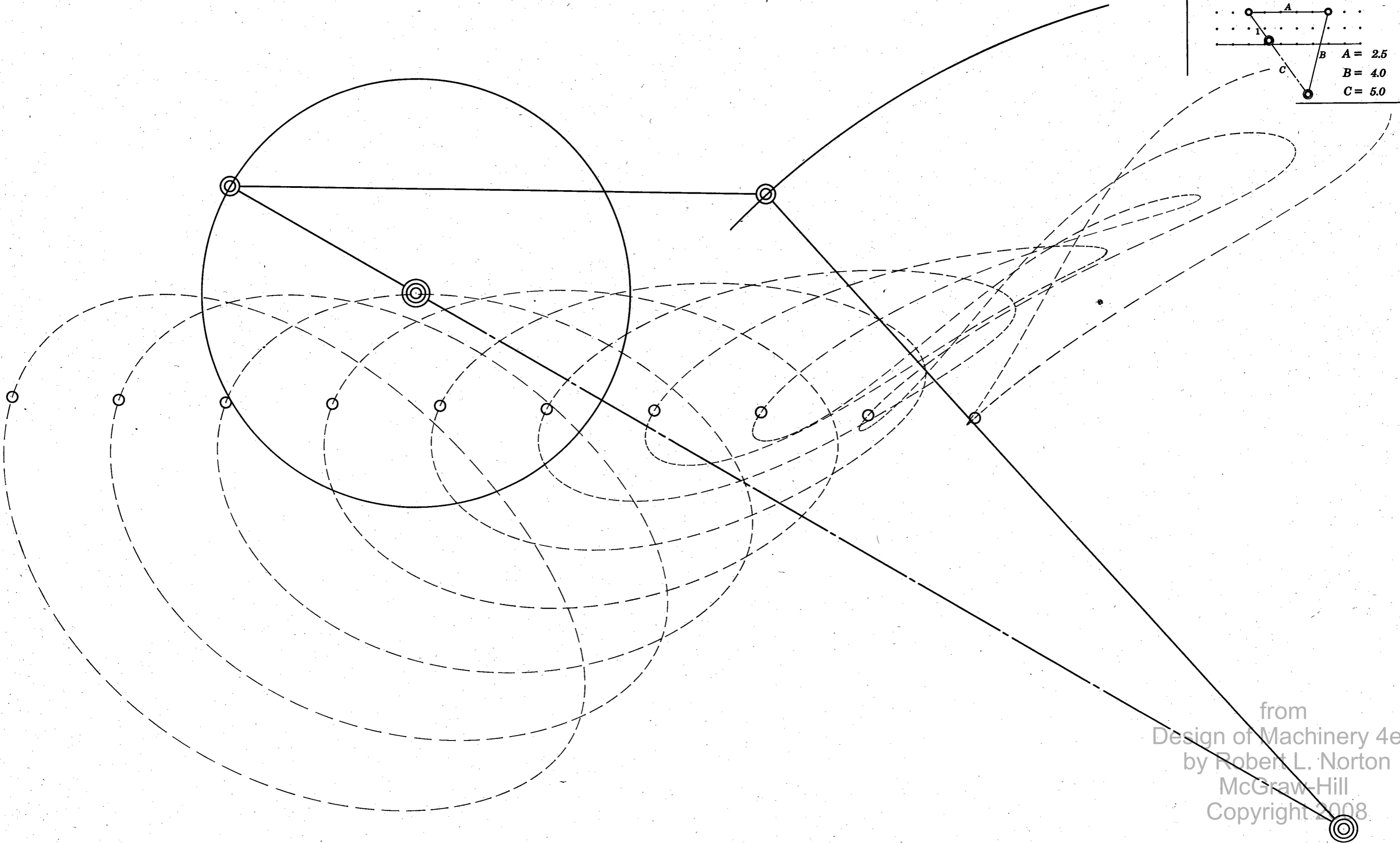

from  
Design of Machinery 4ed  
by Robert L. Norton  
McGraw-Hill  
Copyright 2008

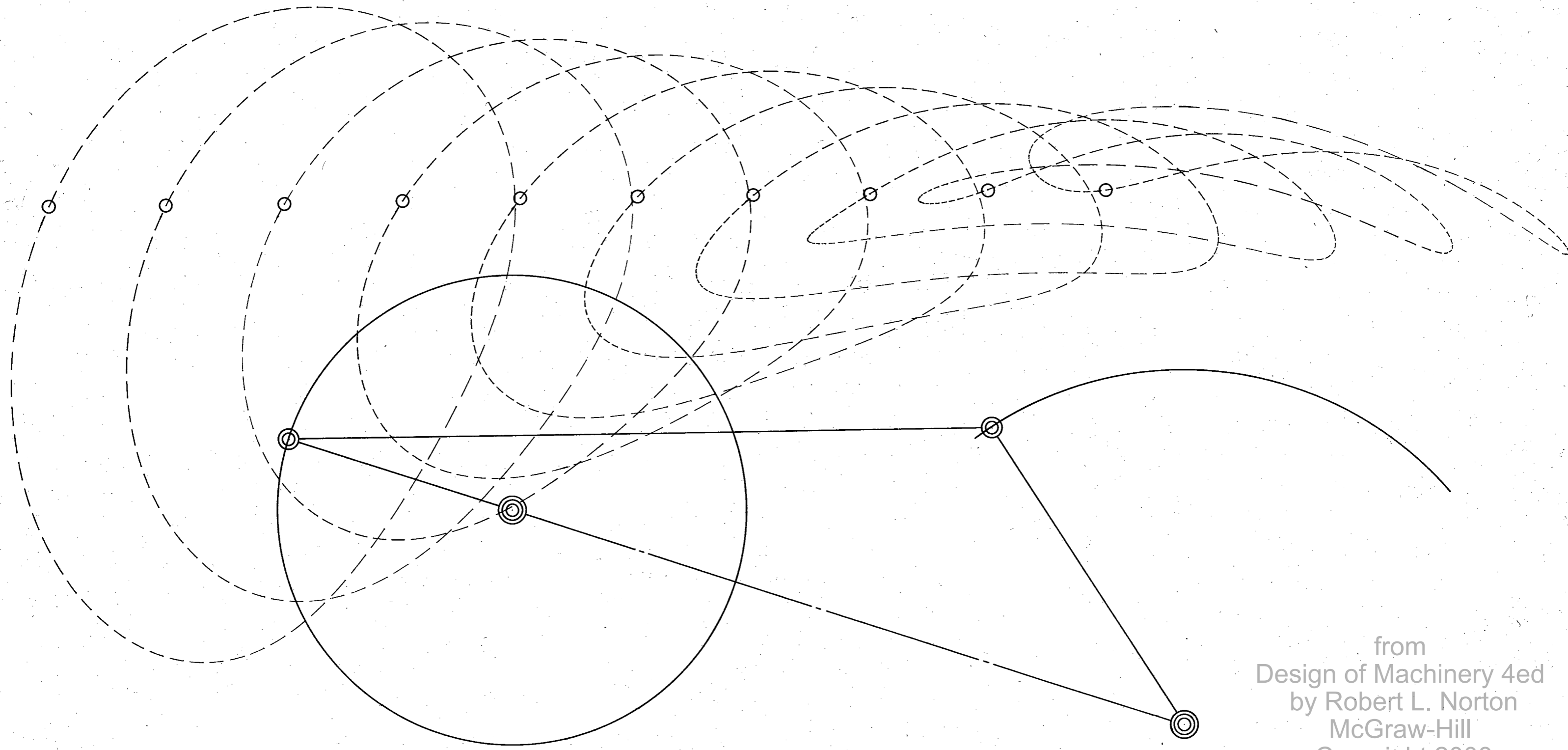
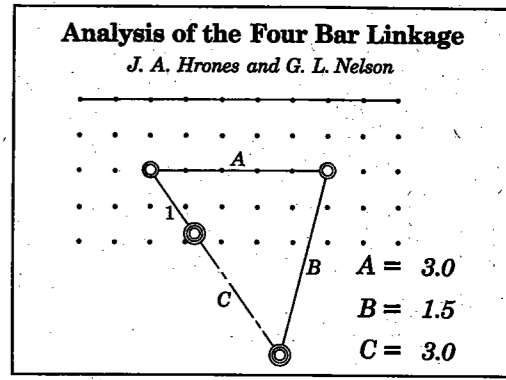

from  
 Design of Machinery 4ed  
 by Robert L. Norton  
 McGraw-Hill  
 Copyright 2008

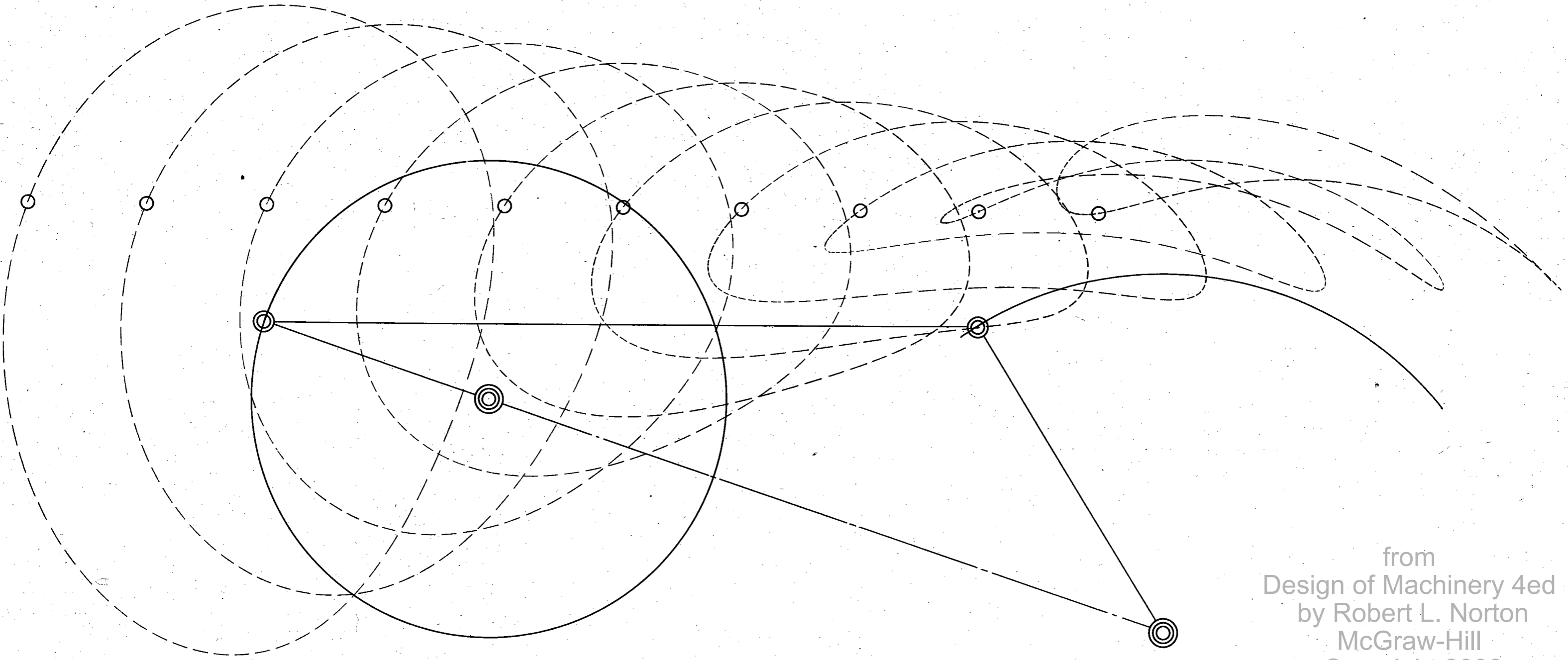
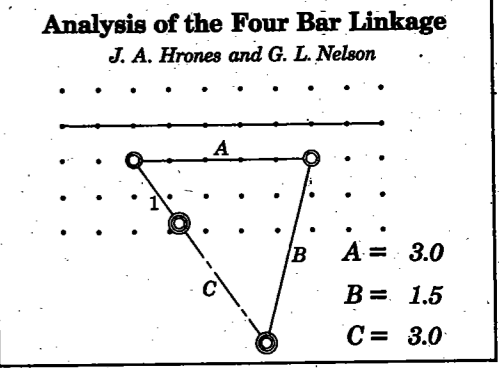

from  
Design of Machinery 4ed  
by Robert L. Norton  
McGraw-Hill  
Copyright 2008

**Analysis of the Four Bar Linkage**  
*J. A. Hrones and G. L. Nelson*

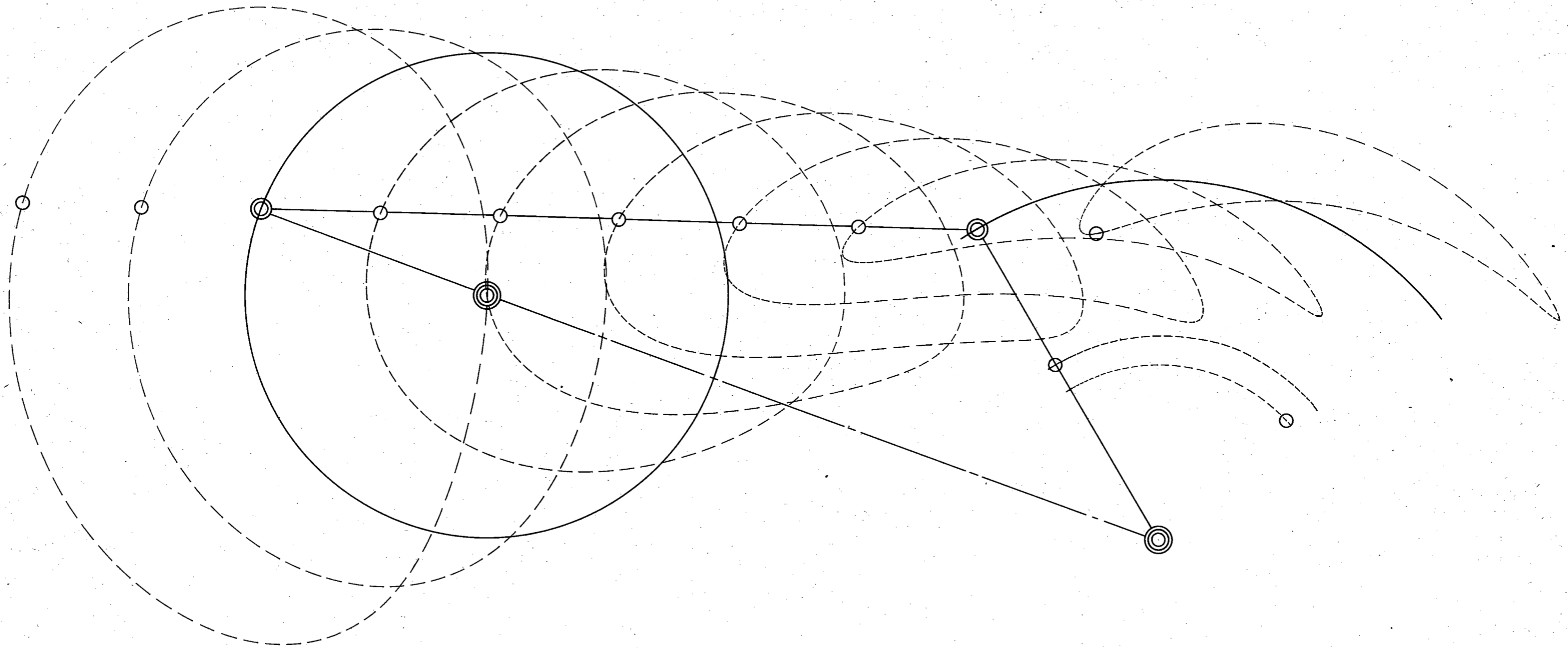
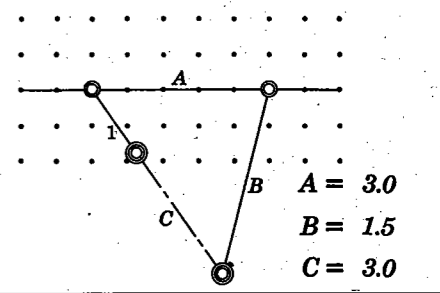

from  
Design of Machinery 4ed  
by Robert L. Norton  
McGraw-Hill  
Copyright 2008



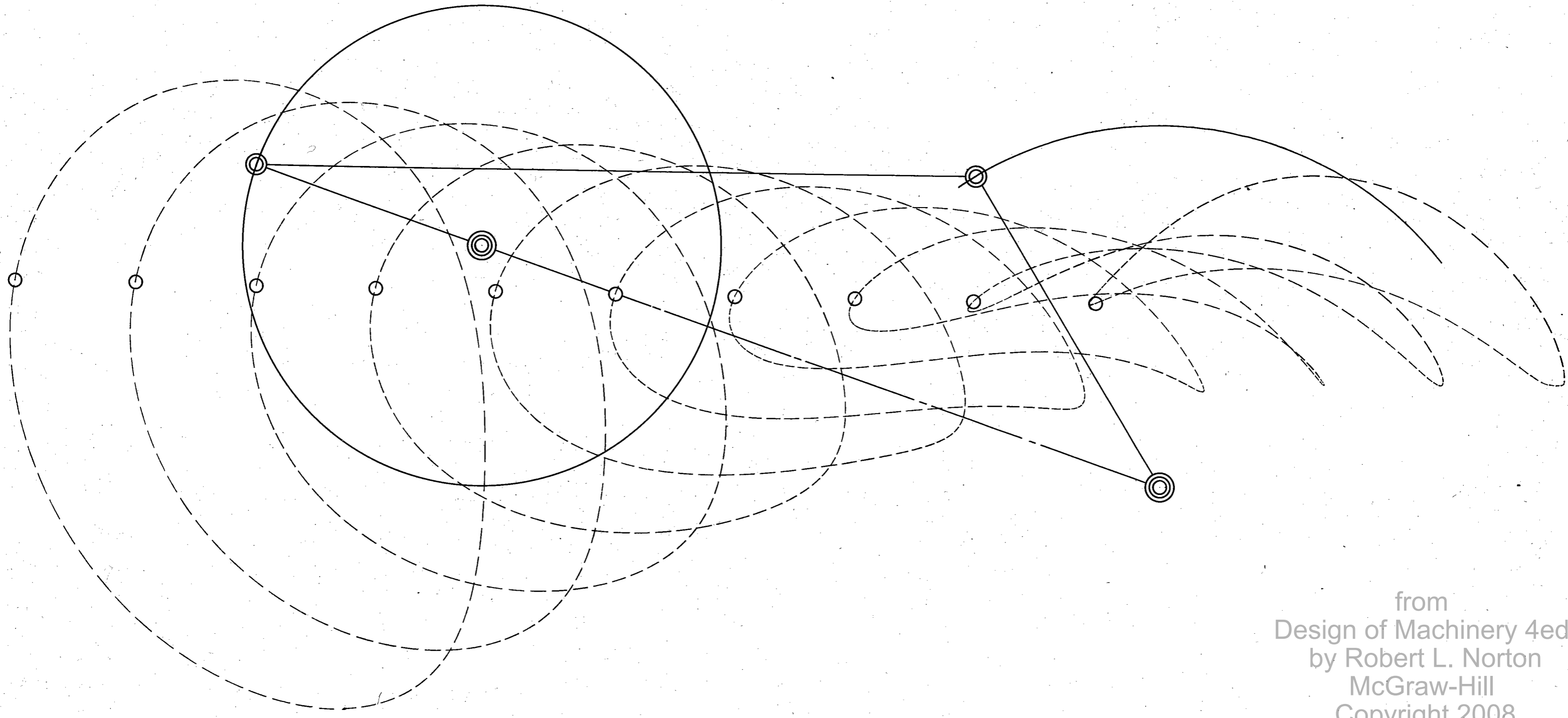
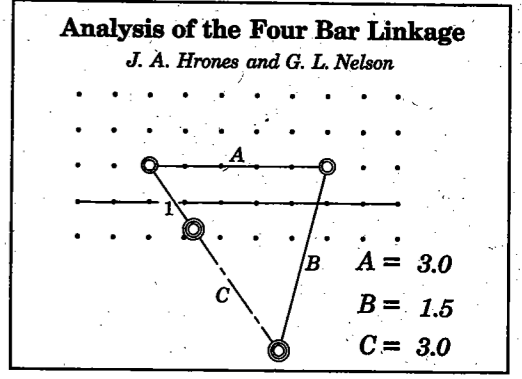

from  
Design of Machinery 4ed  
by Robert L. Norton  
McGraw-Hill  
Copyright 2008

**Analysis of the Four Bar Linkage**

*J. A. Hrones and G. L. Nelson*

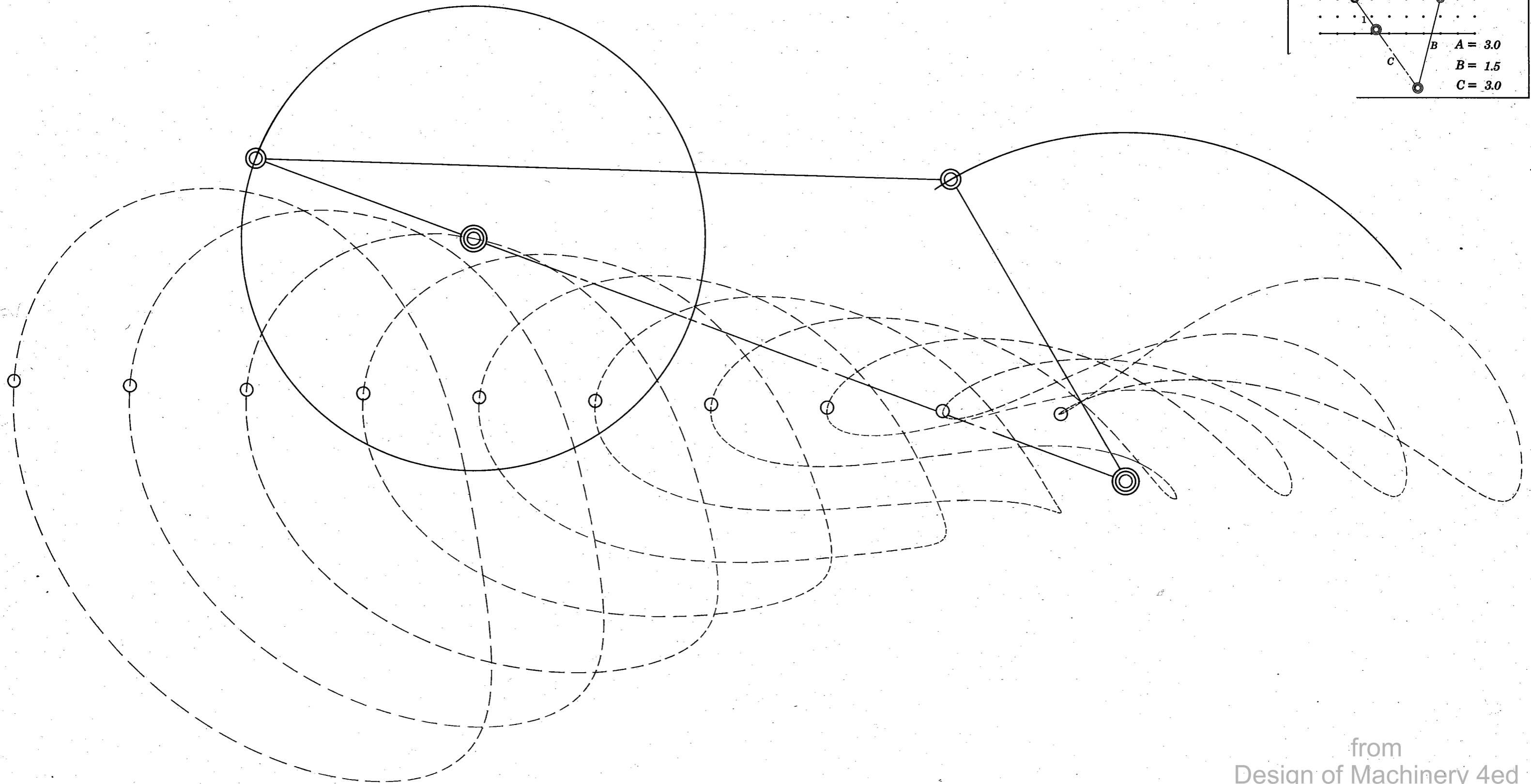
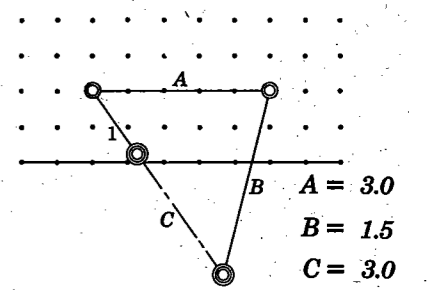

from  
Design of Machinery 4ed  
by Robert L. Norton  
McGraw-Hill  
Copyright 2008

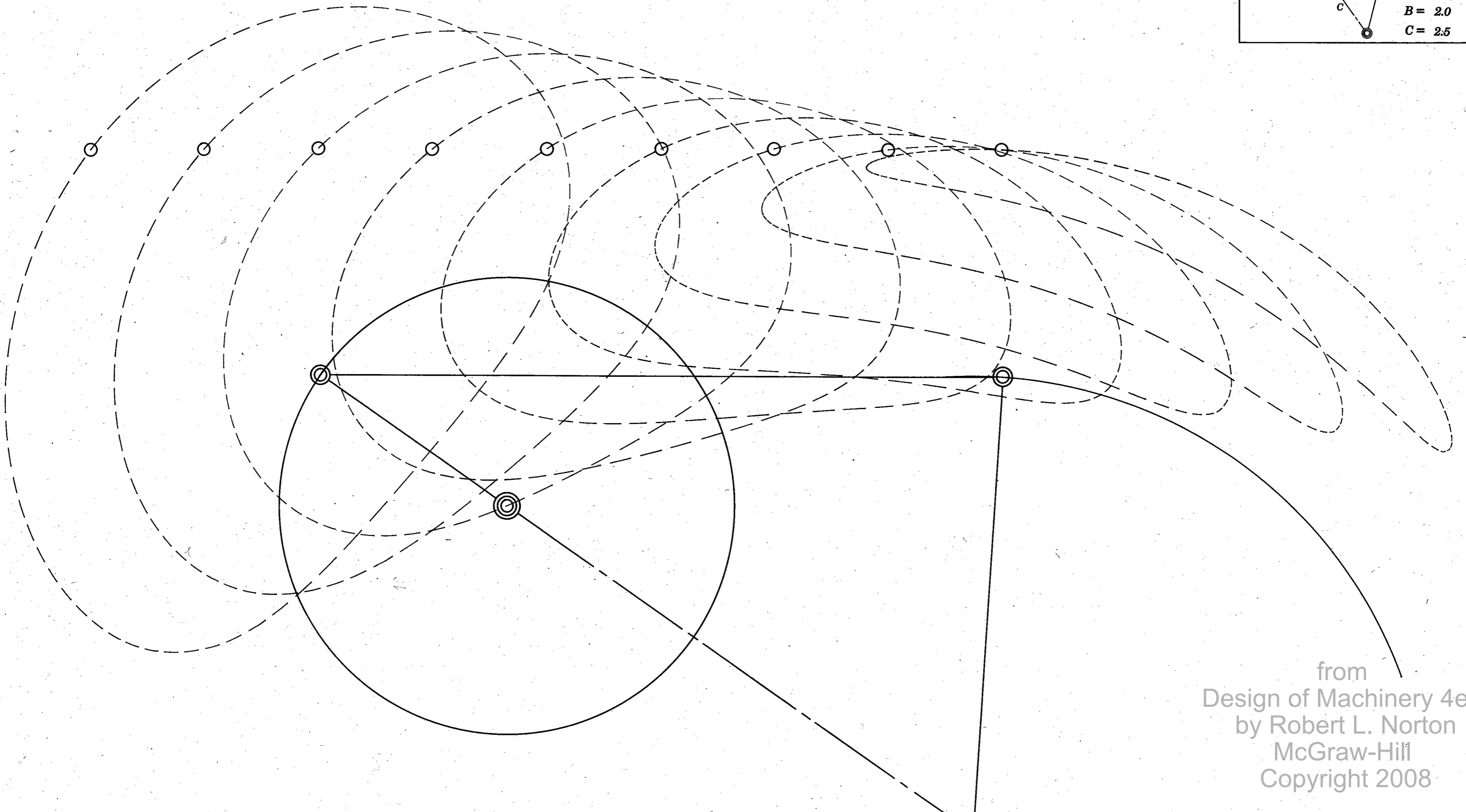
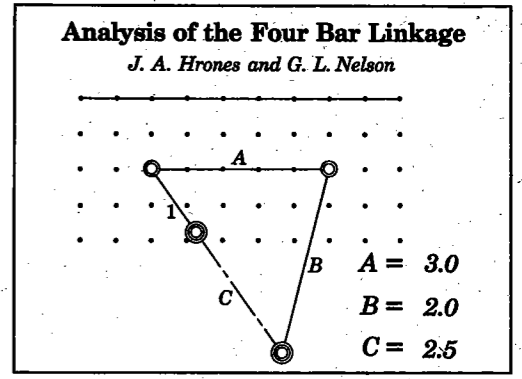

from  
Design of Machinery 4ed  
by Robert L. Norton  
McGraw-Hill  
Copyright 2008

**Analysis of the Four Bar Linkage**

*J. A. Hrones and G. L. Nelson*

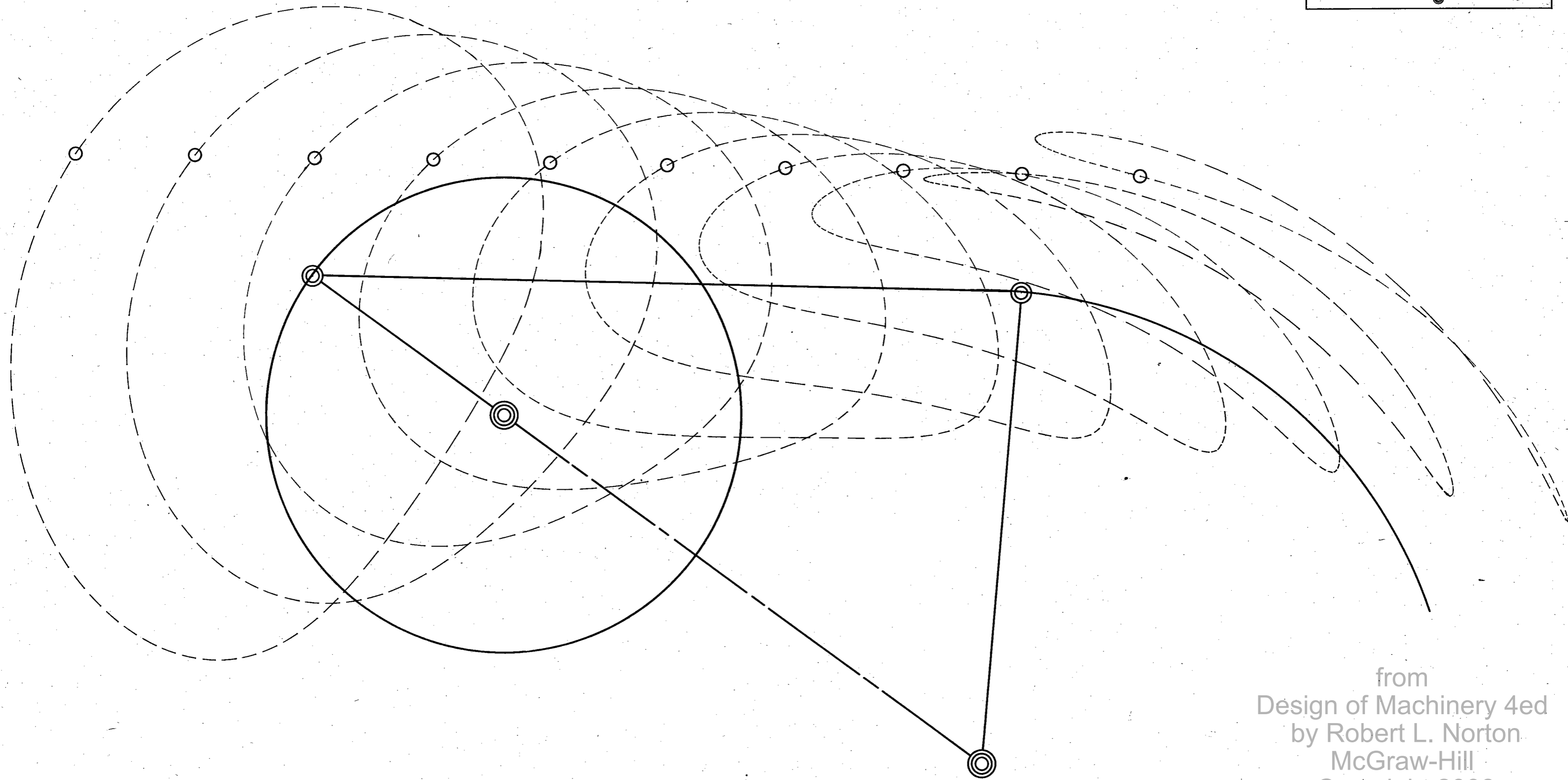
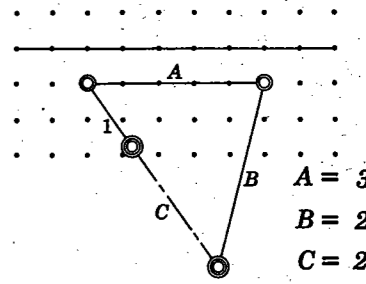

from  
Design of Machinery 4ed  
by Robert L. Norton  
McGraw-Hill  
Copyright 2008

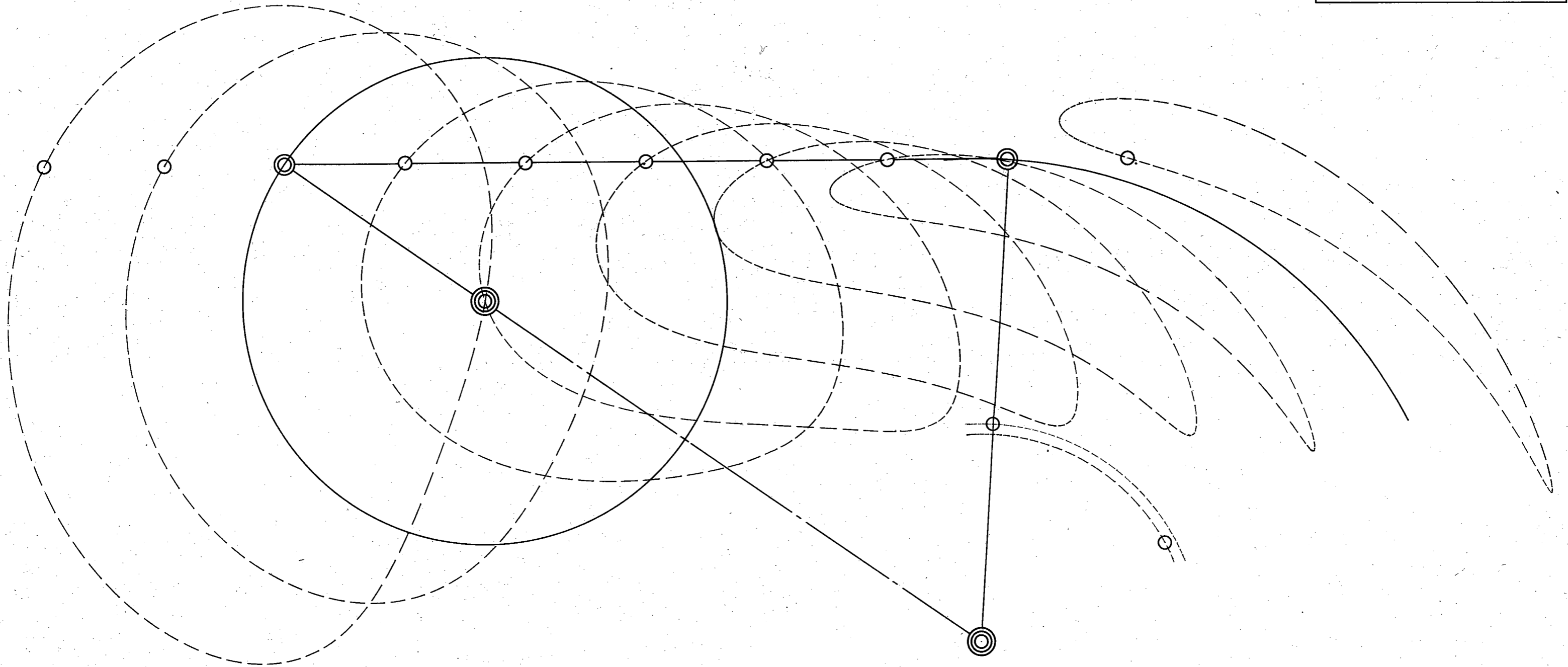
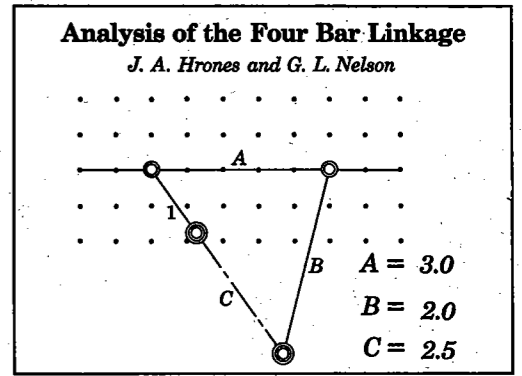

from  
Design of Machinery 4ed  
by Robert L. Norton  
McGraw-Hill  
Copyright 2008

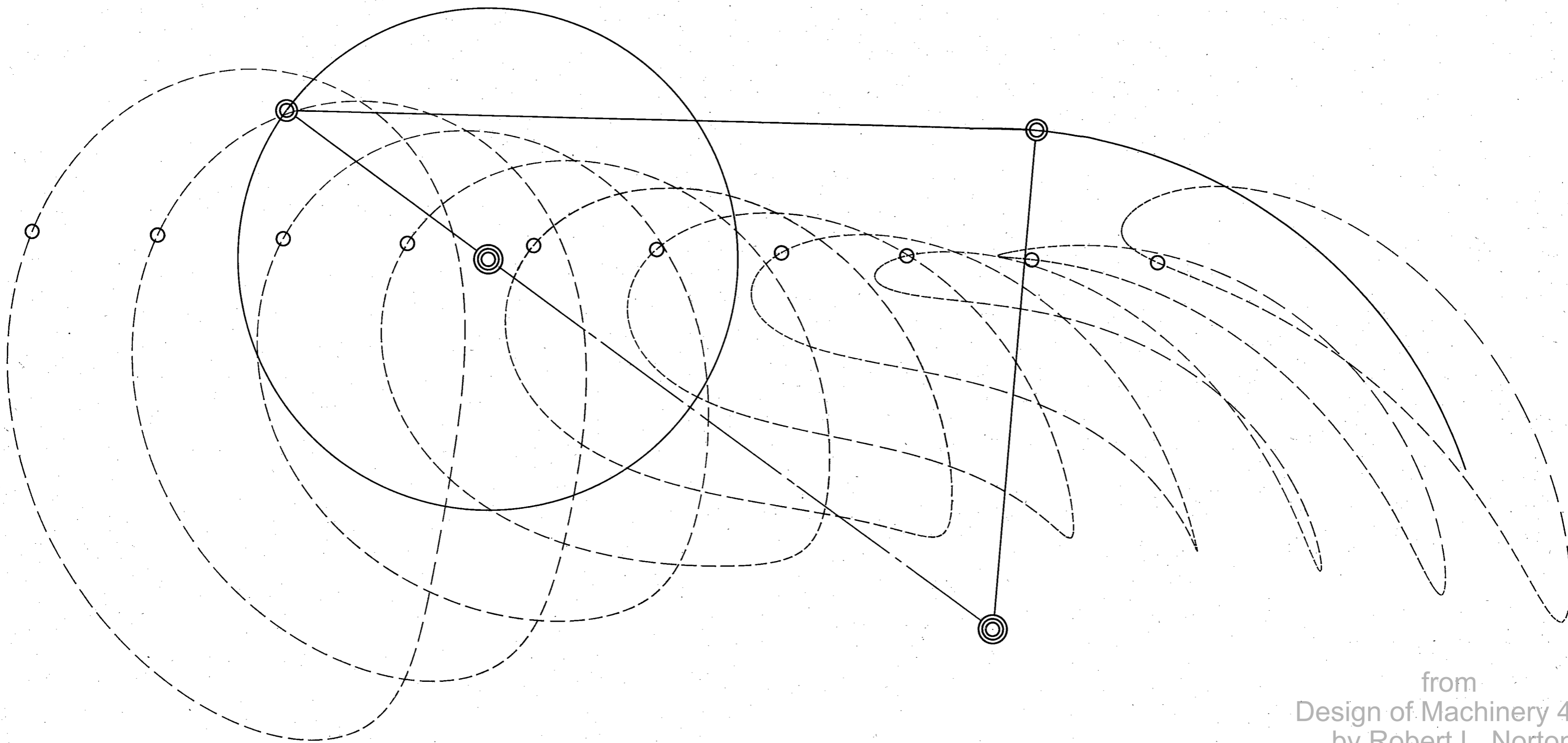
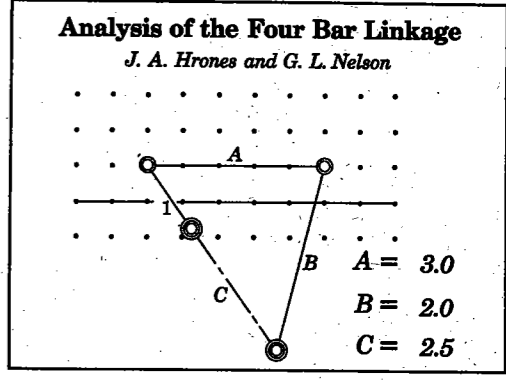

from  
 Design of Machinery 4ed  
 by Robert L. Norton  
 McGraw-Hill  
 Copyright 2008

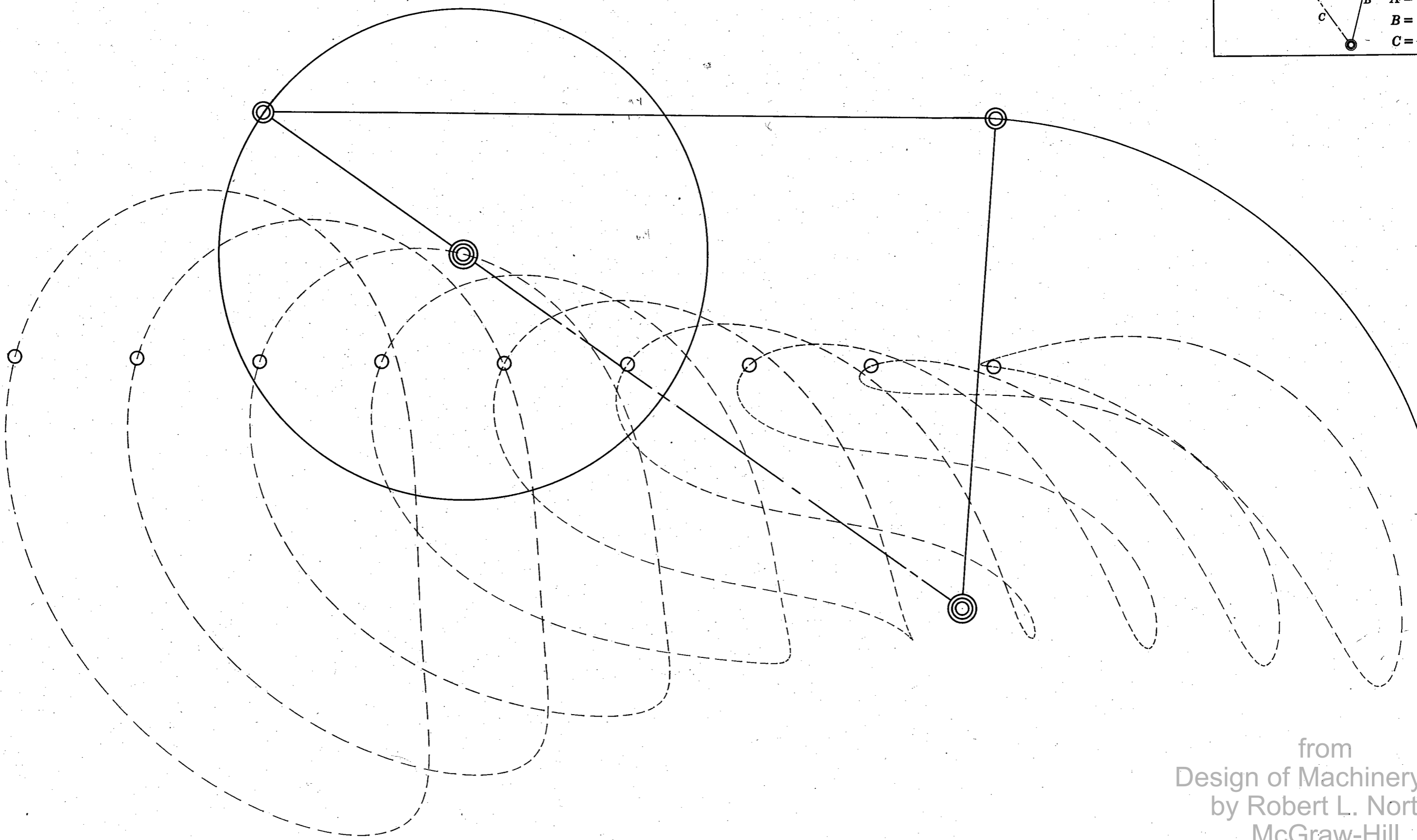
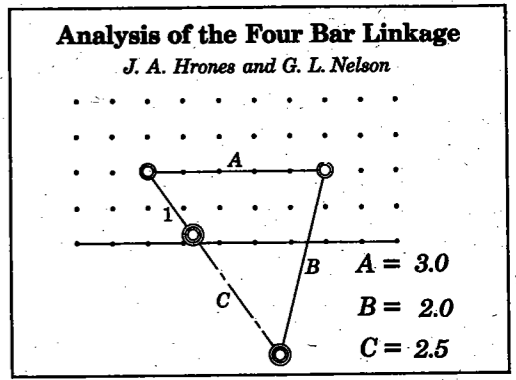

from  
Design of Machinery 4ed  
by Robert L. Norton  
McGraw-Hill  
Copyright 2008

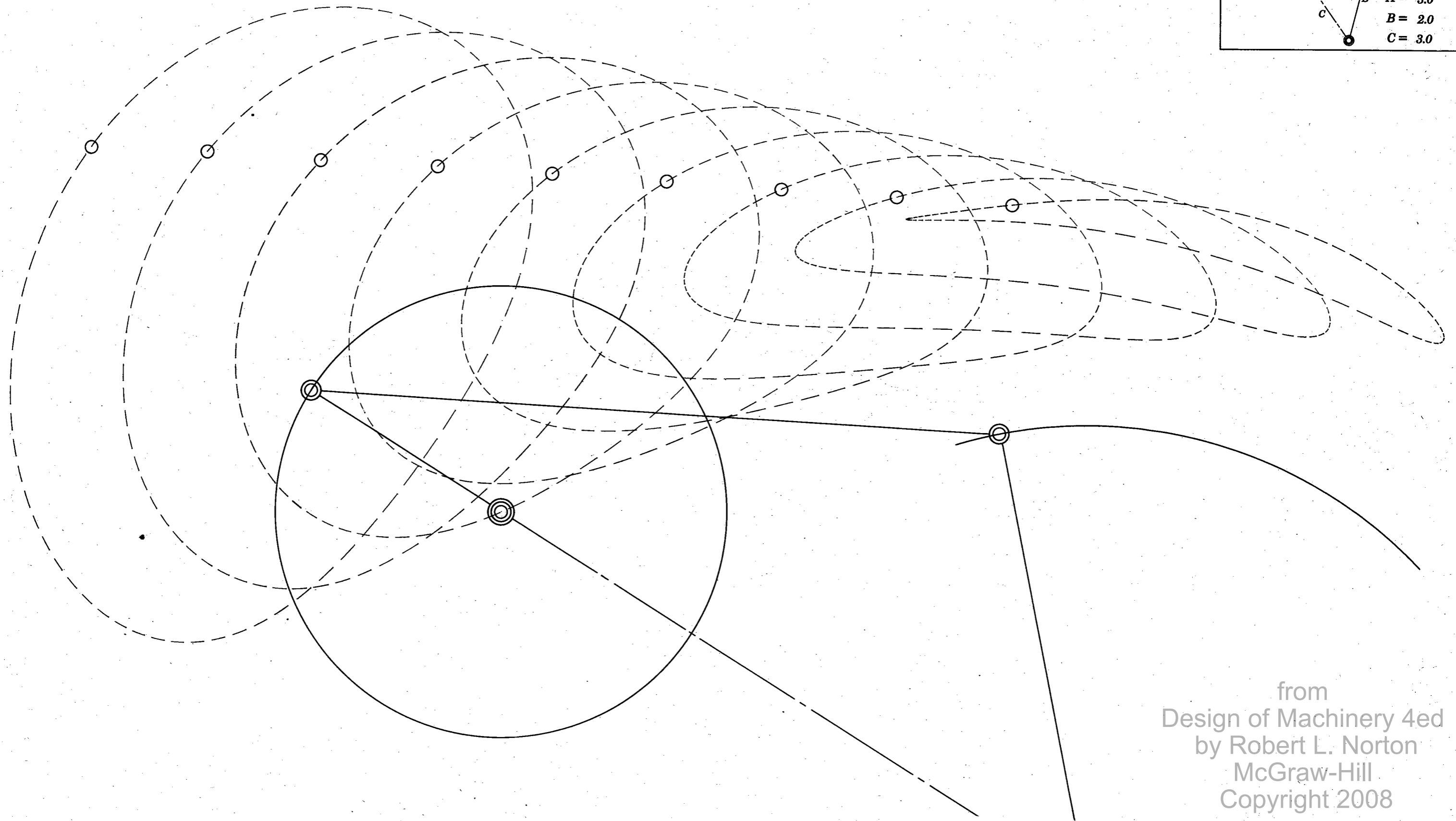
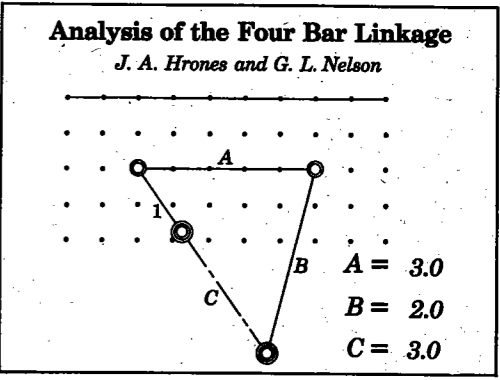

from  
 Design of Machinery 4ed  
 by Robert L. Norton  
 McGraw-Hill  
 Copyright 2008



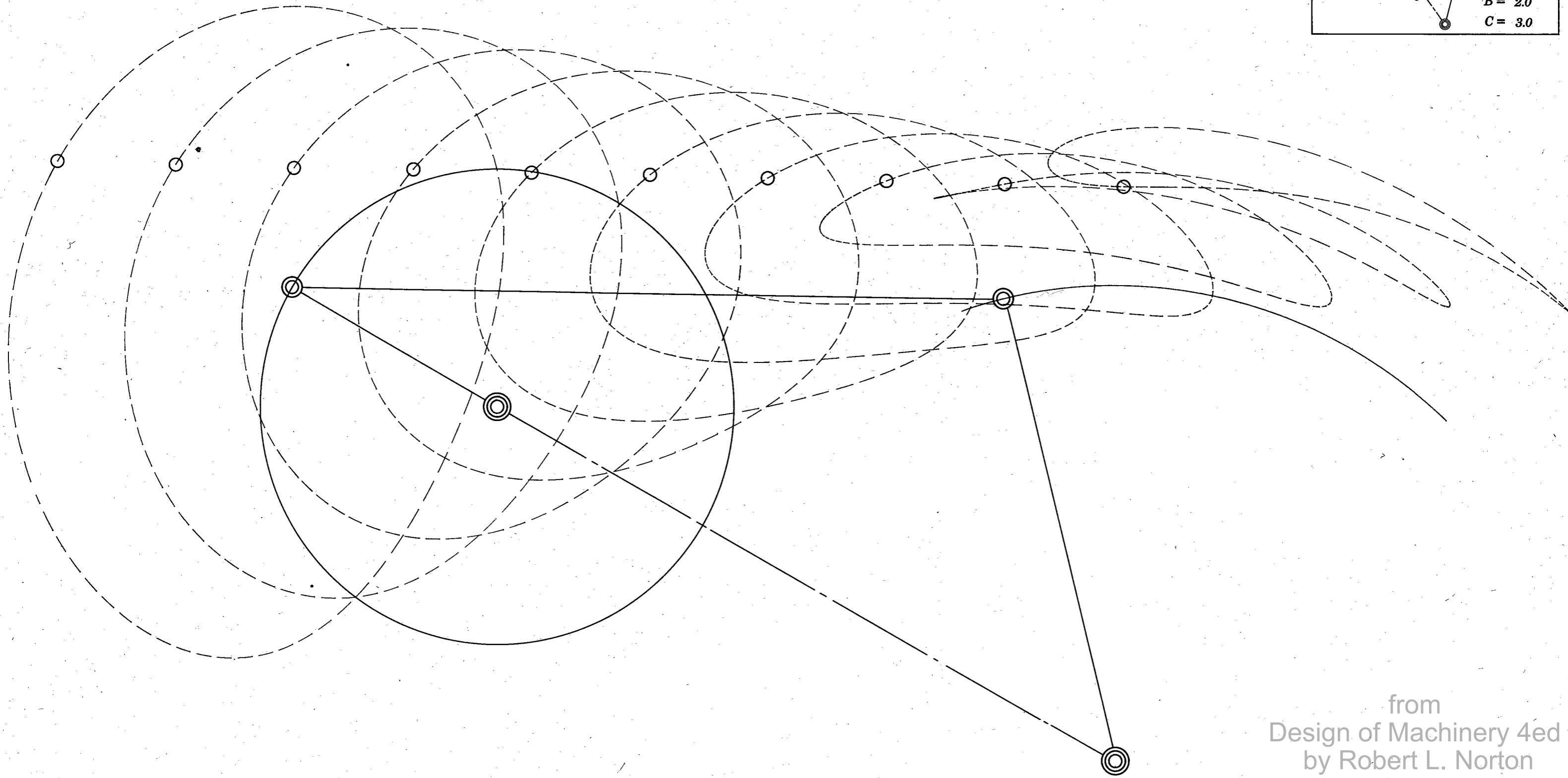
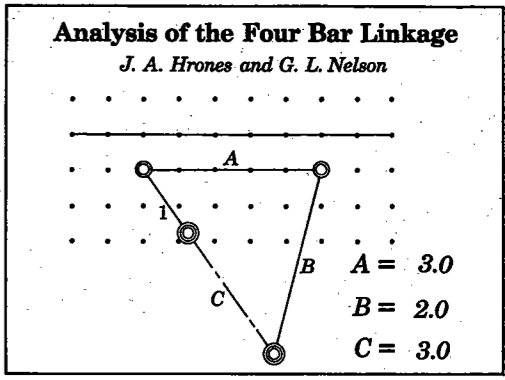

from  
Design of Machinery 4ed  
by Robert L. Norton  
McGraw-Hill  
Copyright 2008

**Analysis of the Four Bar Linkage**  
*J. A. Hrones and G. L. Nelson*

$A = 3.0$   
 $B = 2.0$   
 $C = 3.0$

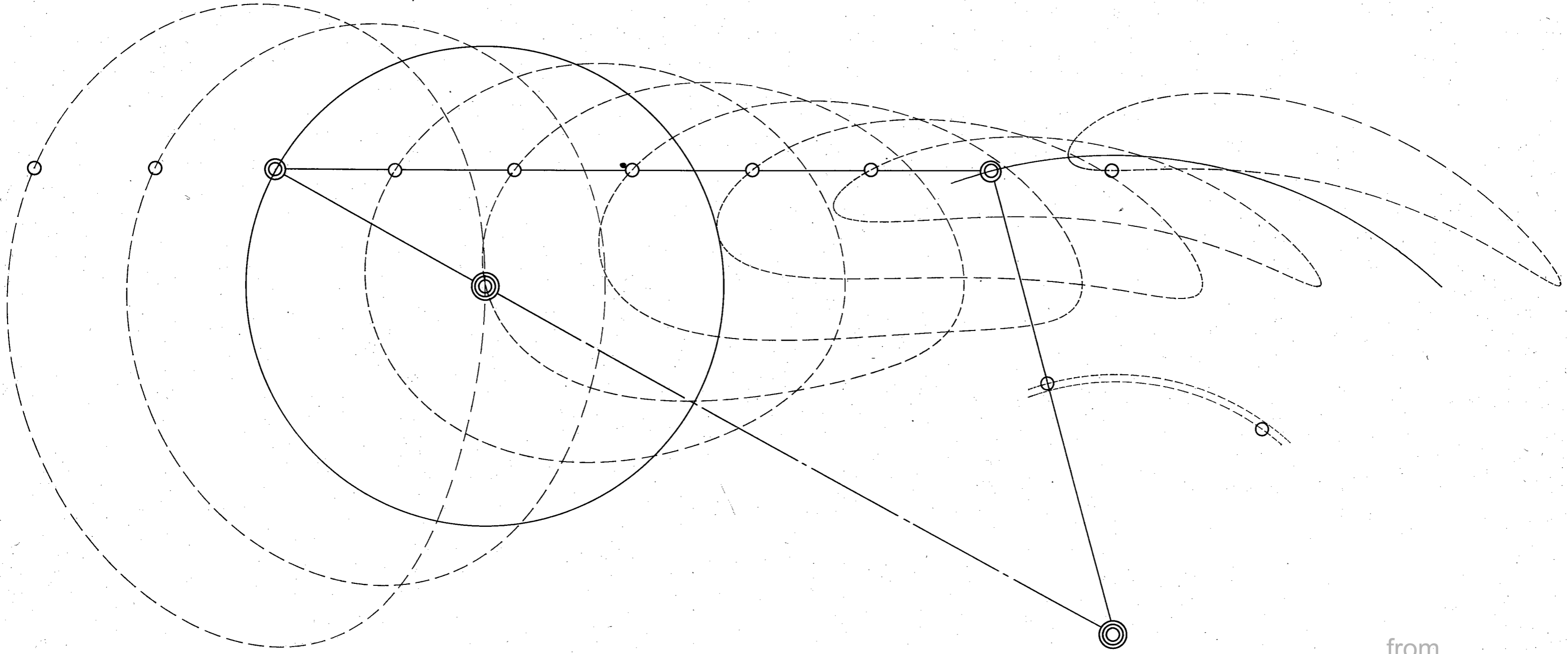

from  
 Design of Machinery 4ed  
 by Robert L. Norton  
 McGraw-Hill  
 Copyright 2008

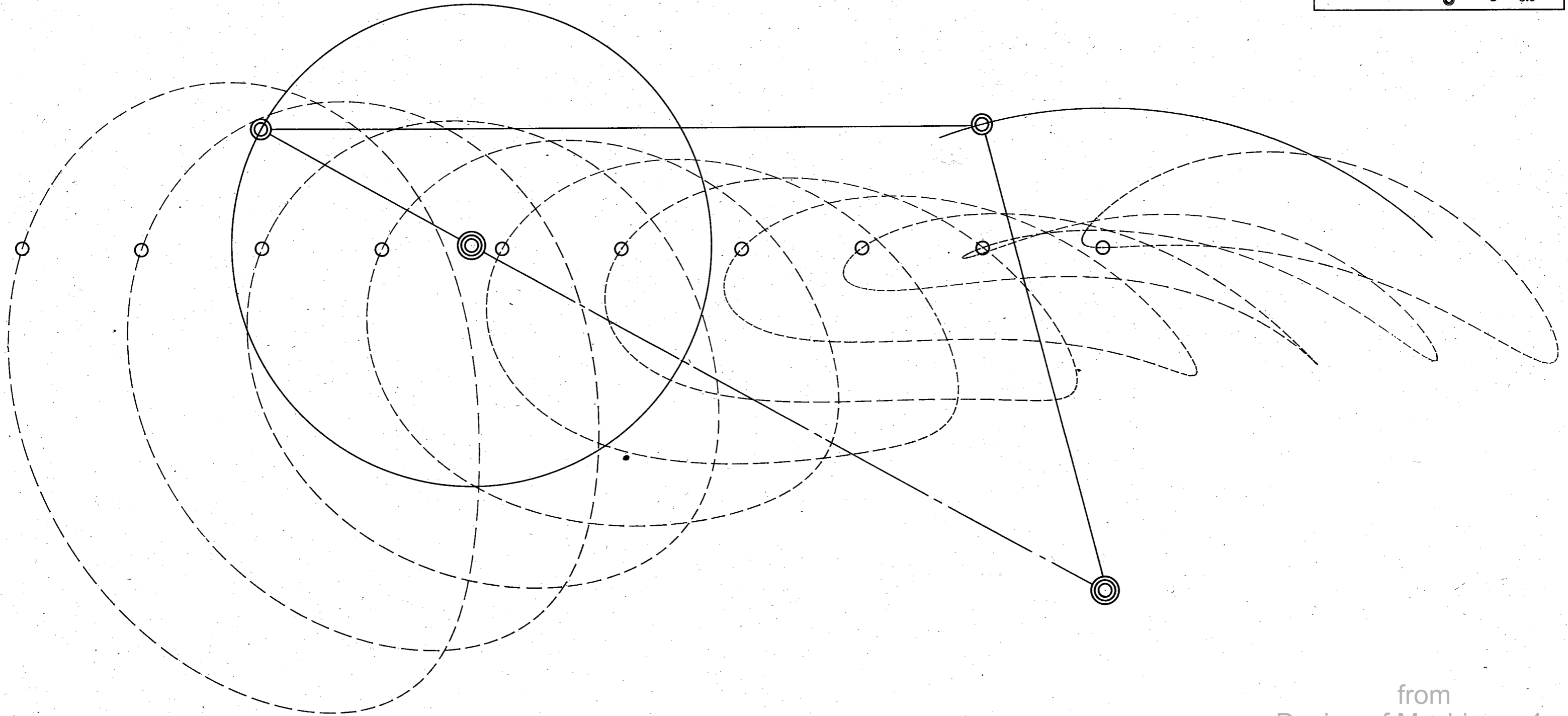
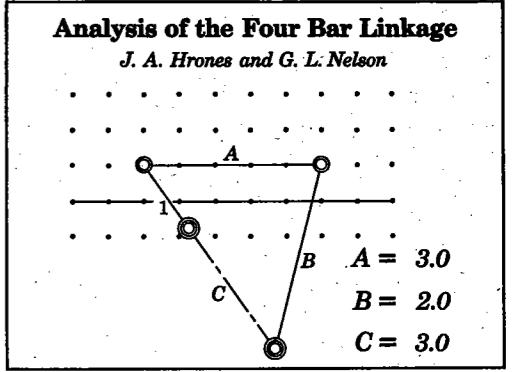

from  
Design of Machinery 4ed  
by Robert L. Norton  
McGraw-Hill  
Copyright 2008

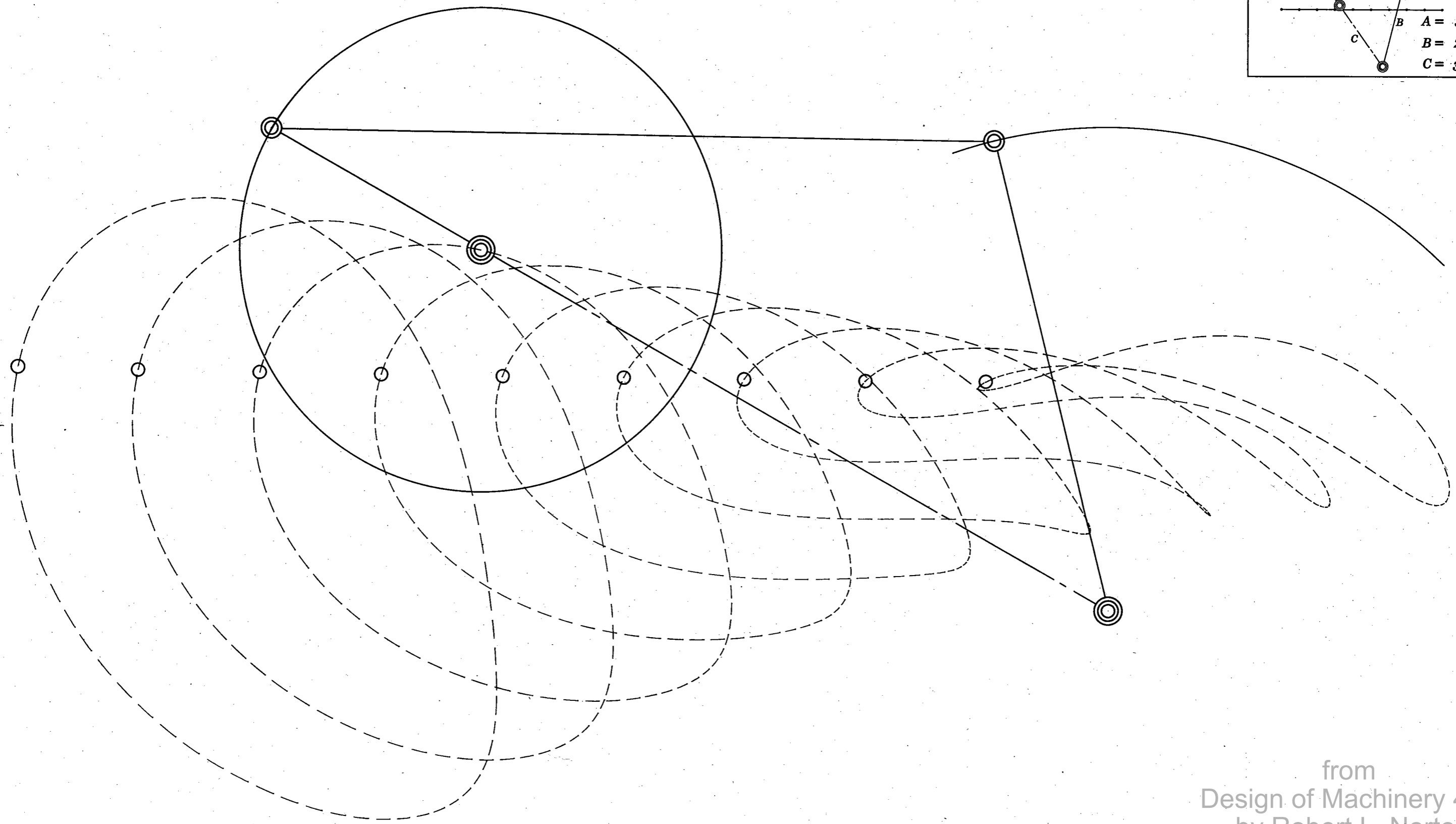
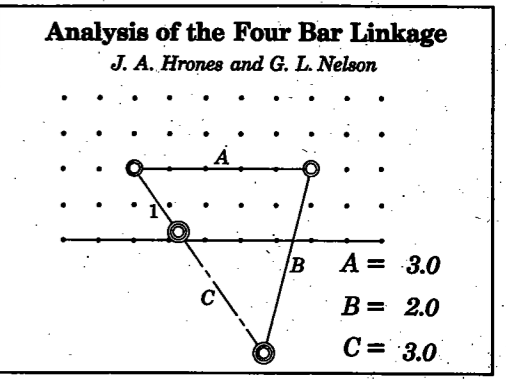

from  
 Design of Machinery 4ed  
 by Robert L. Norton  
 McGraw-Hill  
 Copyright 2008

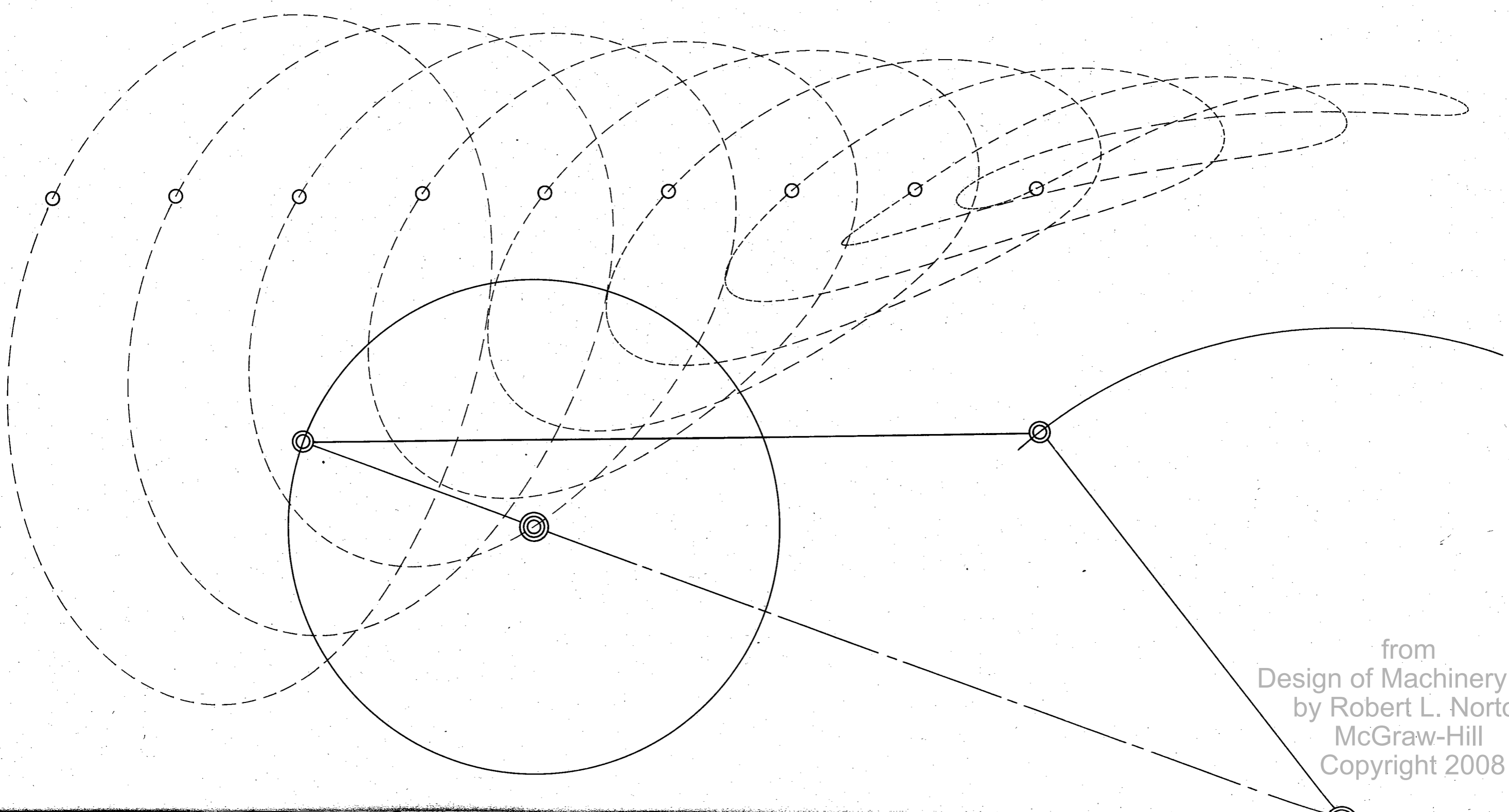
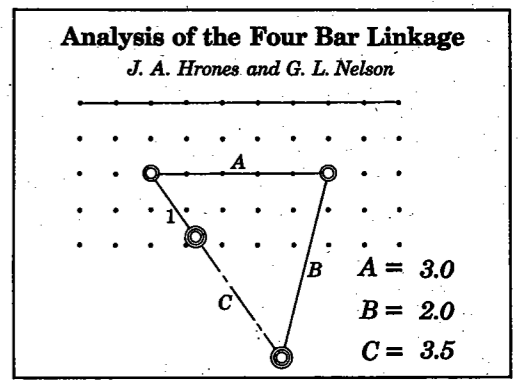

from  
Design of Machinery 4ed  
by Robert L. Norton  
McGraw-Hill  
Copyright 2008

**Analysis of the Four Bar Linkage**

*J. A. Hrones and G. L. Nelson*

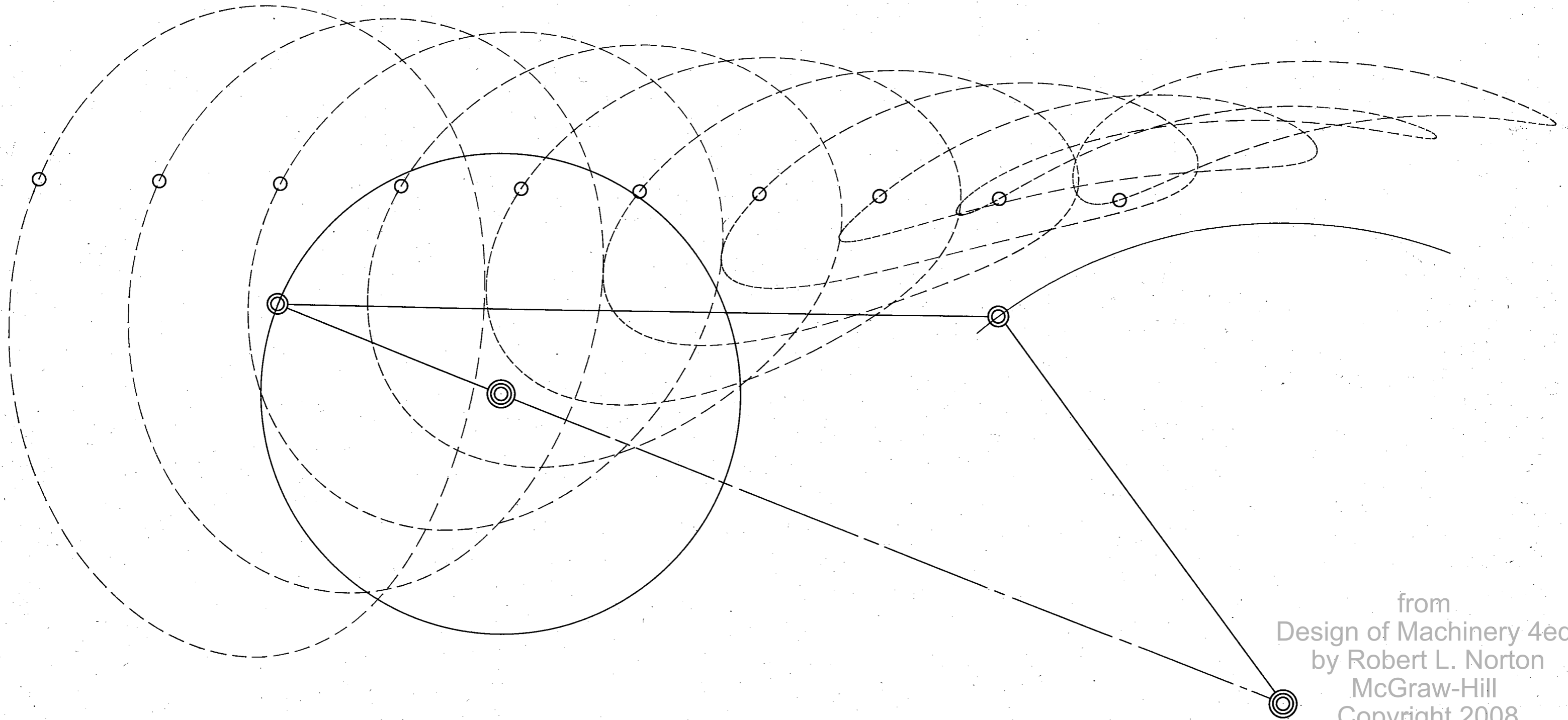
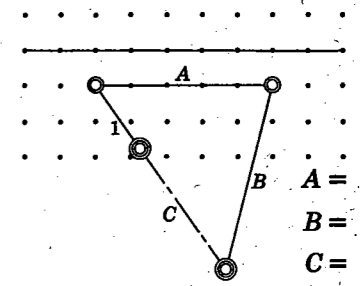

from  
Design of Machinery 4ed  
by Robert L. Norton  
McGraw-Hill  
Copyright 2008

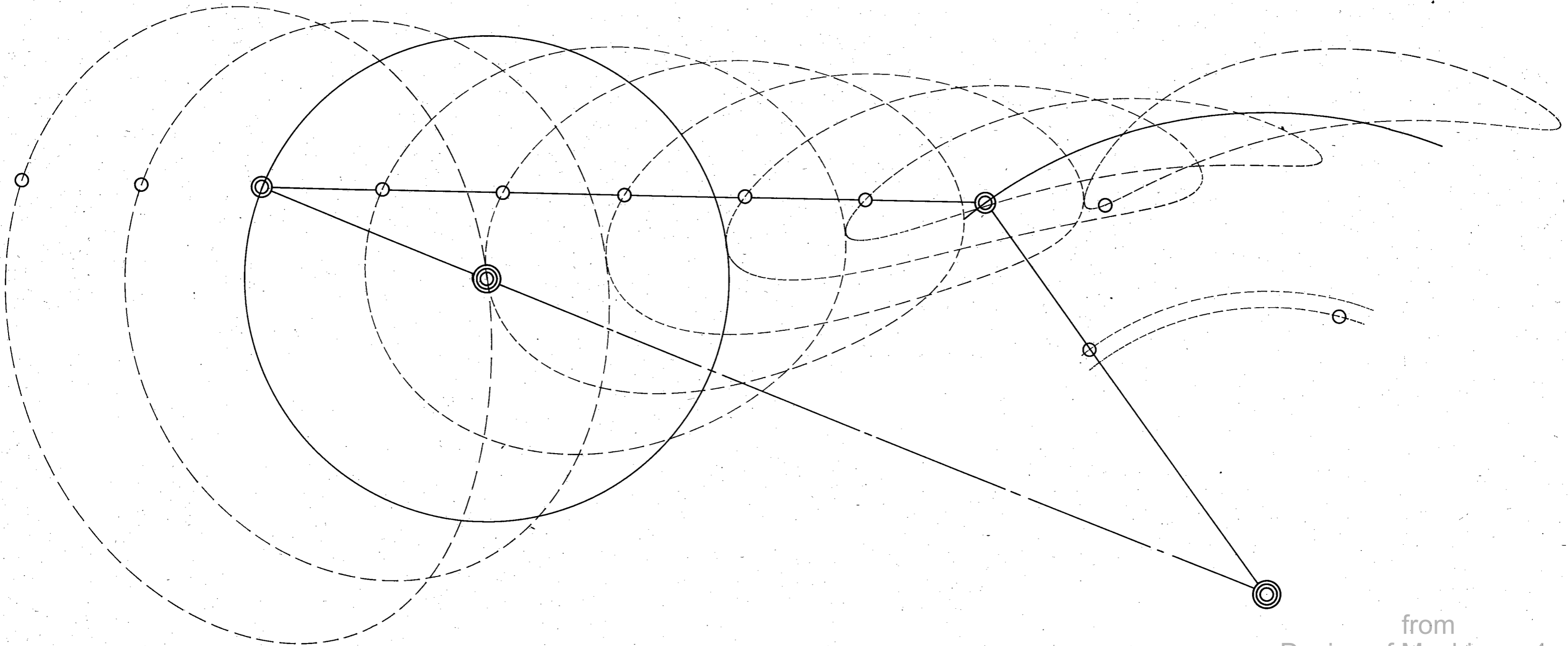
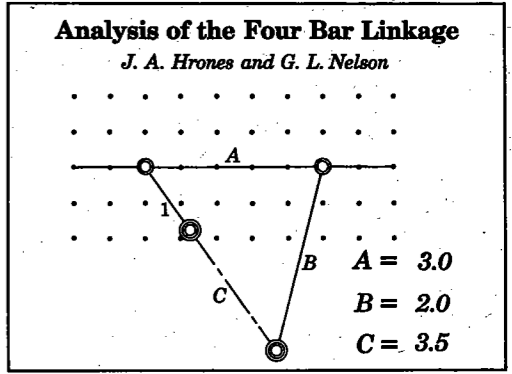

from  
Design of Machinery 4ed  
by Robert L. Norton  
McGraw-Hill  
Copyright 2008

**Analysis of the Four Bar Linkage**

*J. A. Hrones and G. L. Nelson*

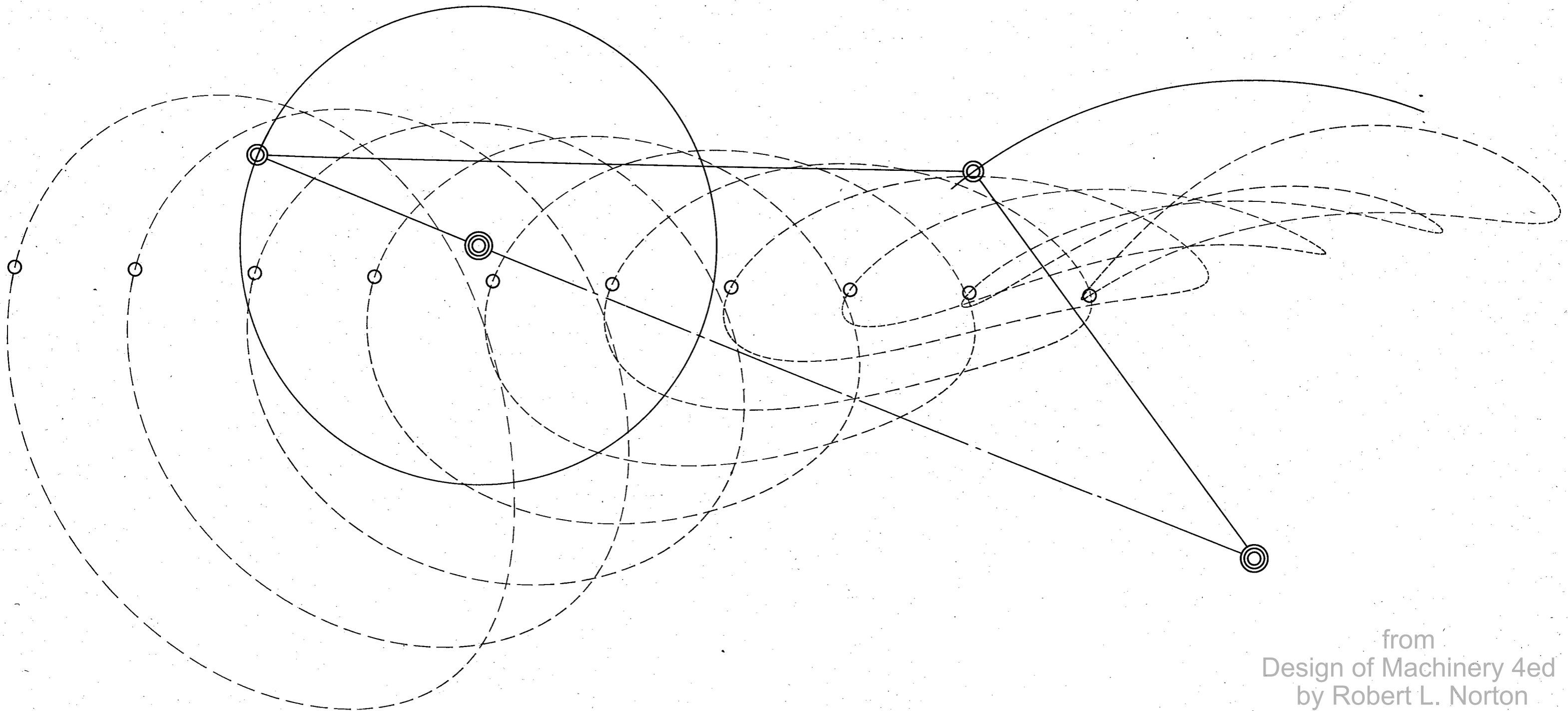
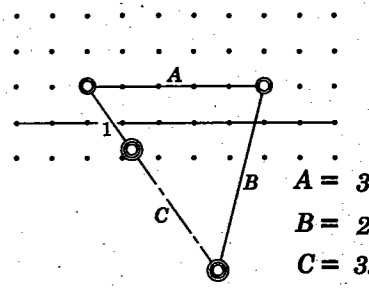

from  
Design of Machinery 4ed  
by Robert L. Norton  
McGraw-Hill  
Copyright 2008



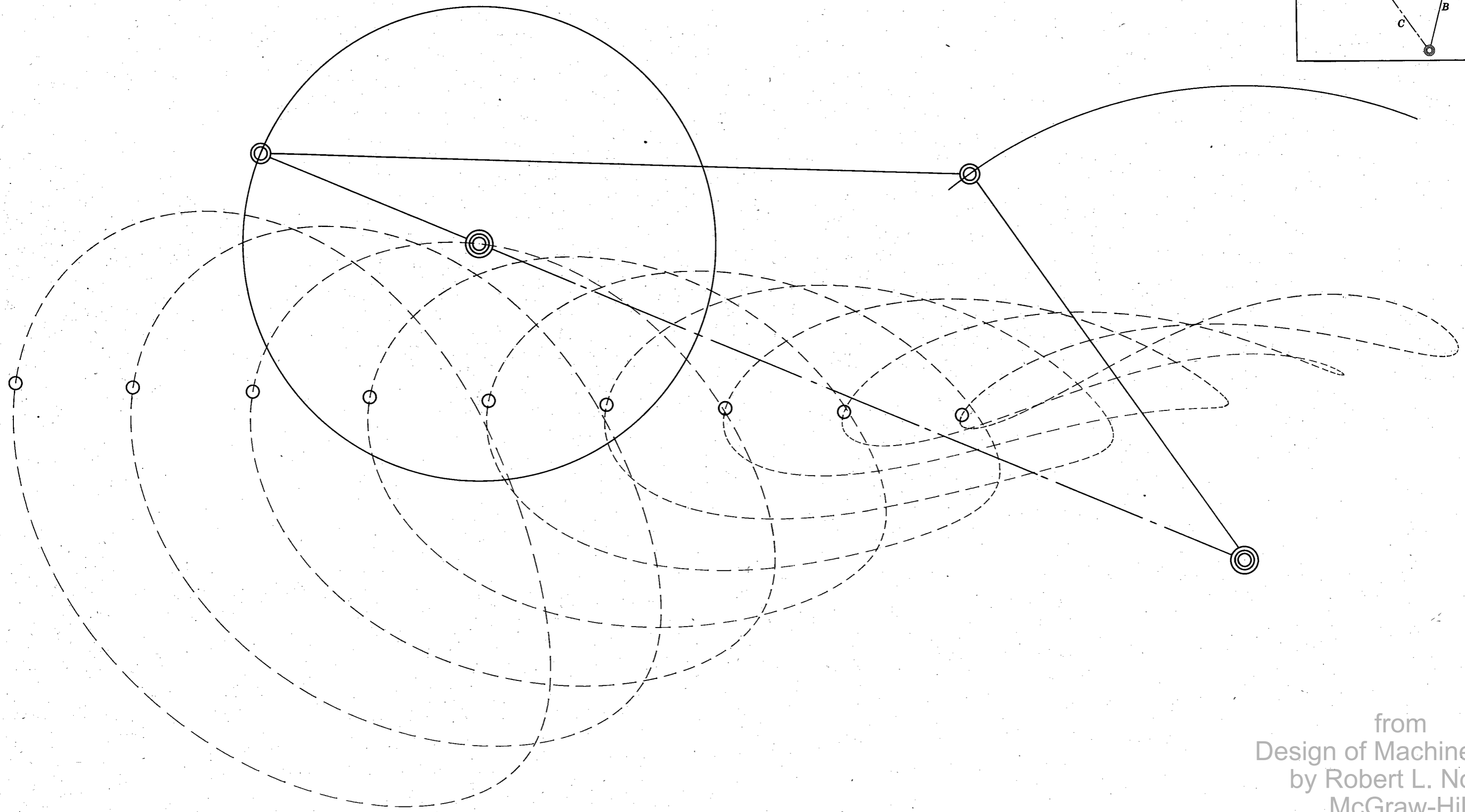
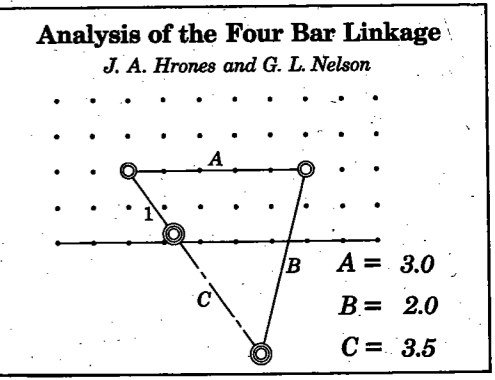

from  
Design of Machinery 4ed  
by Robert L. Norton  
McGraw-Hill  
Copyright 2008

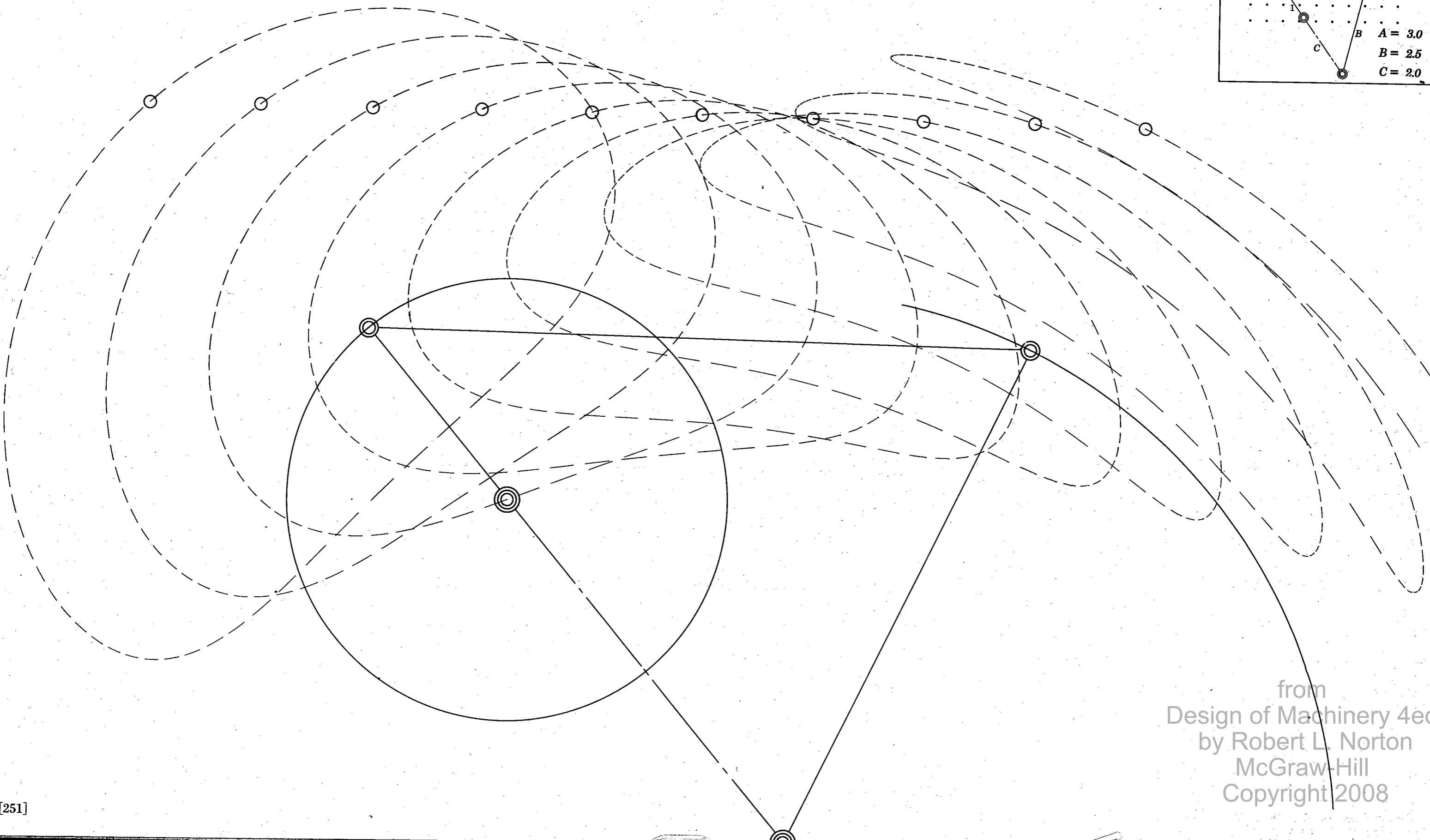
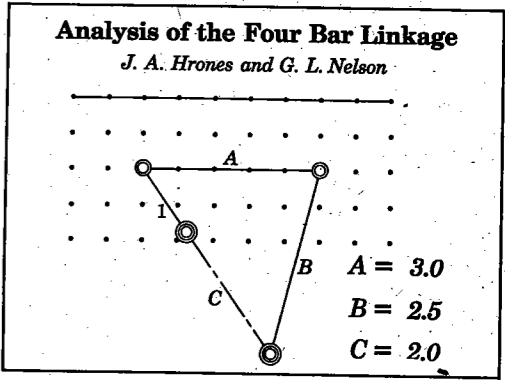

from  
 Design of Machinery 4ed  
 by Robert L. Norton  
 McGraw-Hill  
 Copyright 2008

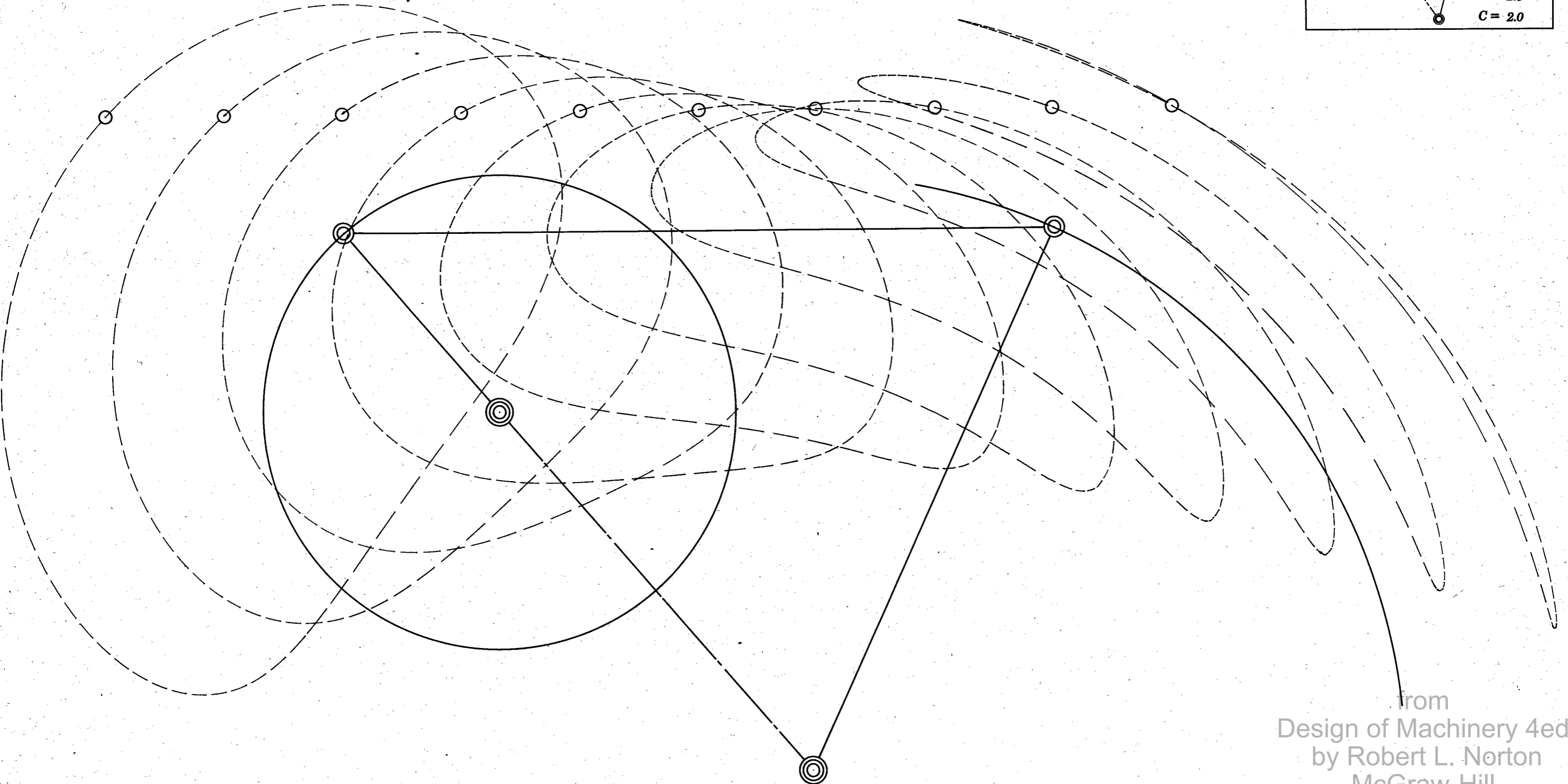
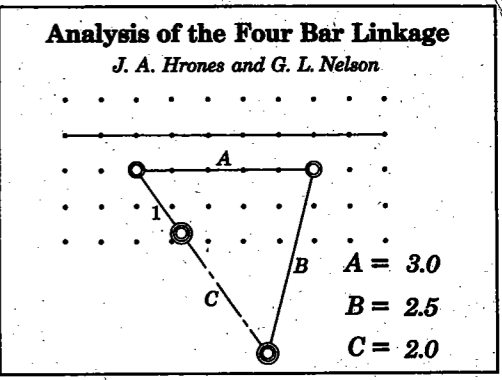

from  
Design of Machinery 4ed  
by Robert L. Norton  
McGraw-Hill  
Copyright 2008

**Analysis of the Four Bar Linkage**

*J. A. Hrones and G. L. Nelson*

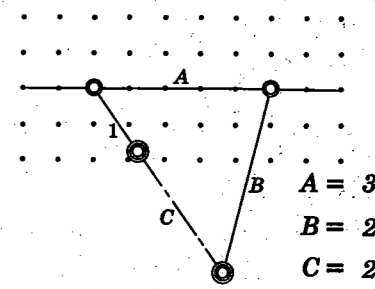

$A = 3.0$   
 $B = 2.5$   
 $C = 2.0$

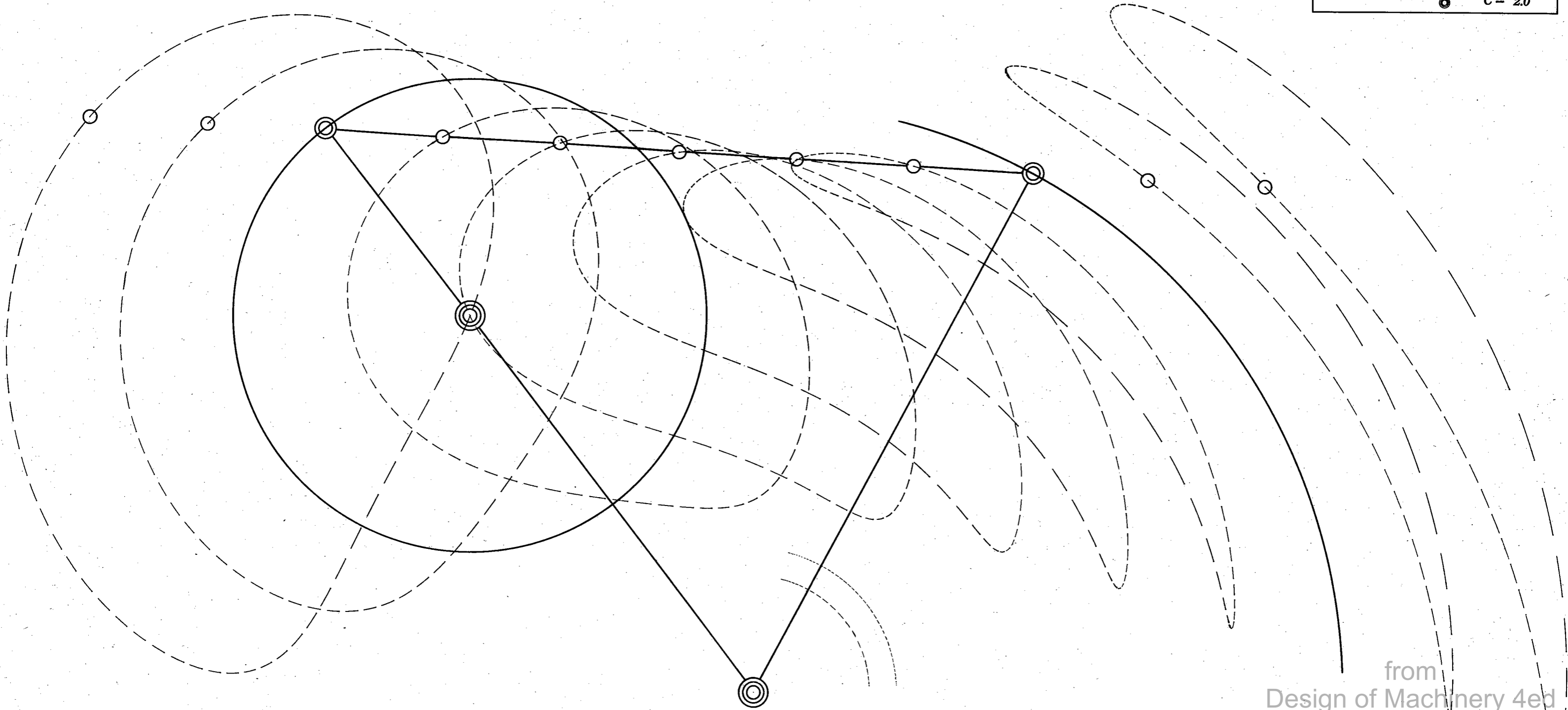

from  
Design of Machinery 4ed  
by Robert L. Norton  
McGraw-Hill  
Copyright 2008

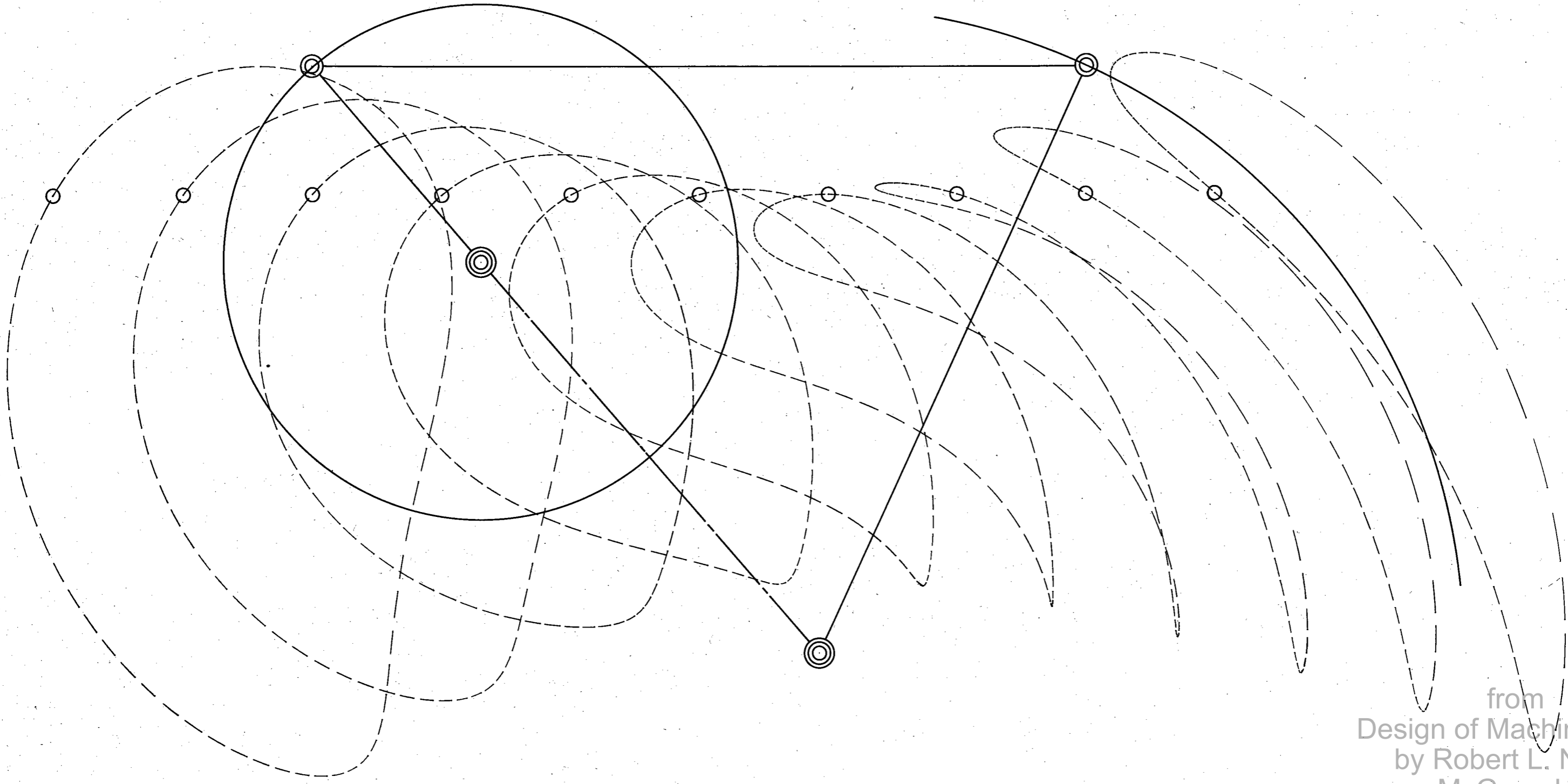
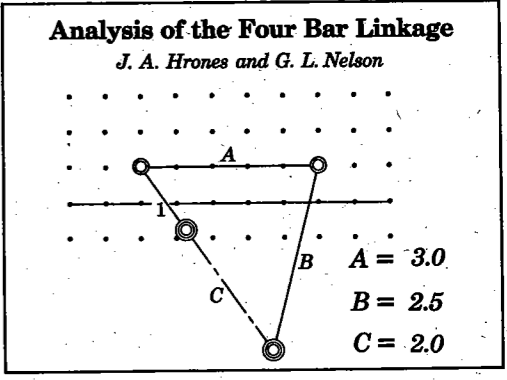

from  
Design of Machinery 4ed  
by Robert L. Norton  
McGraw-Hill  
Copyright 2008

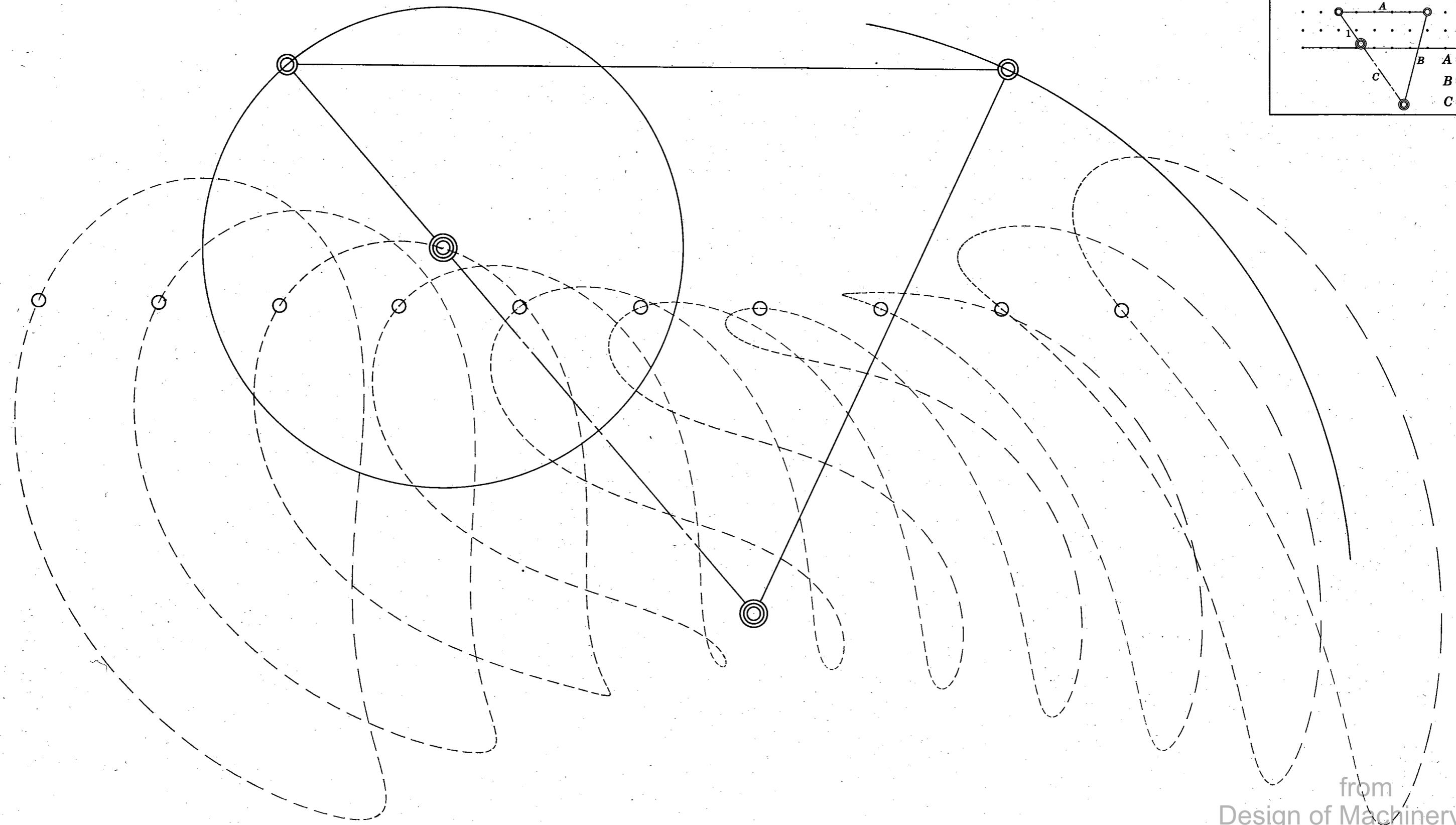
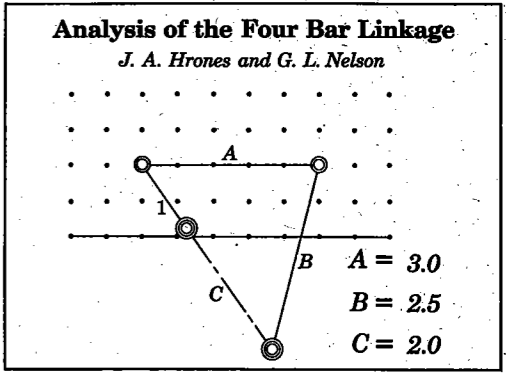

from  
 Design of Machinery 4ed  
 by Robert L. Norton  
 McGraw-Hill  
 Copyright 2008

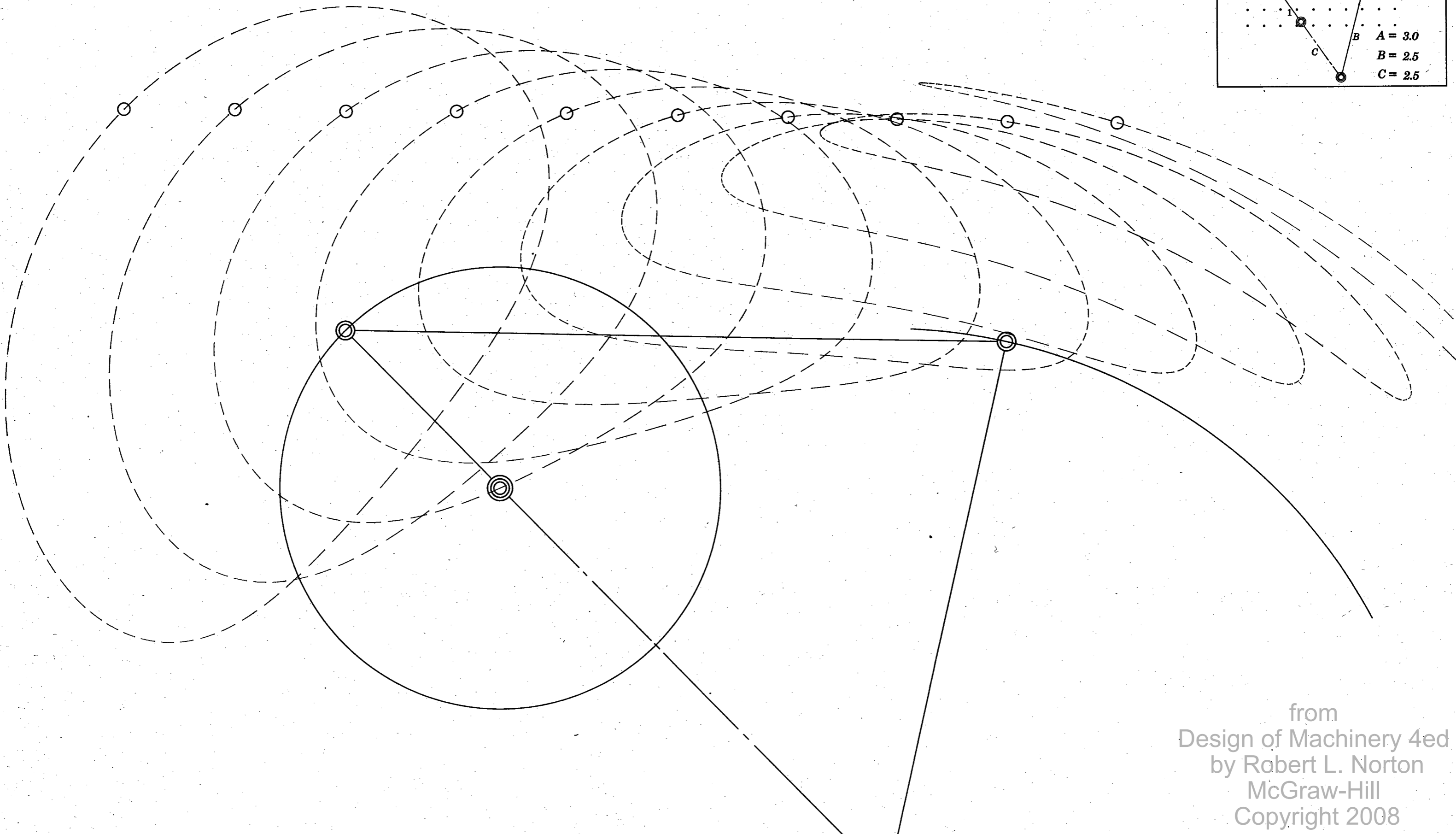
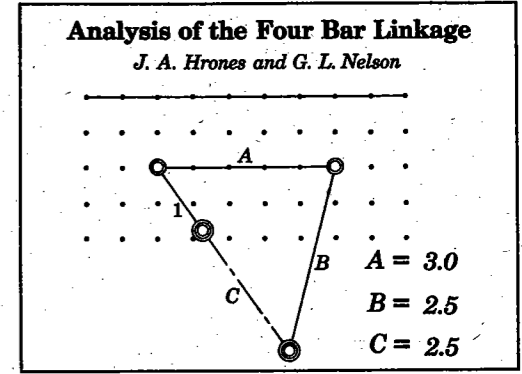

from  
Design of Machinery 4ed  
by Robert L. Norton  
McGraw-Hill  
Copyright 2008

**Analysis of the Four Bar Linkage**  
*J. A. Hrones and G. L. Nelson*

$A = 3.0$   
 $B = 2.5$   
 $C = 2.5$

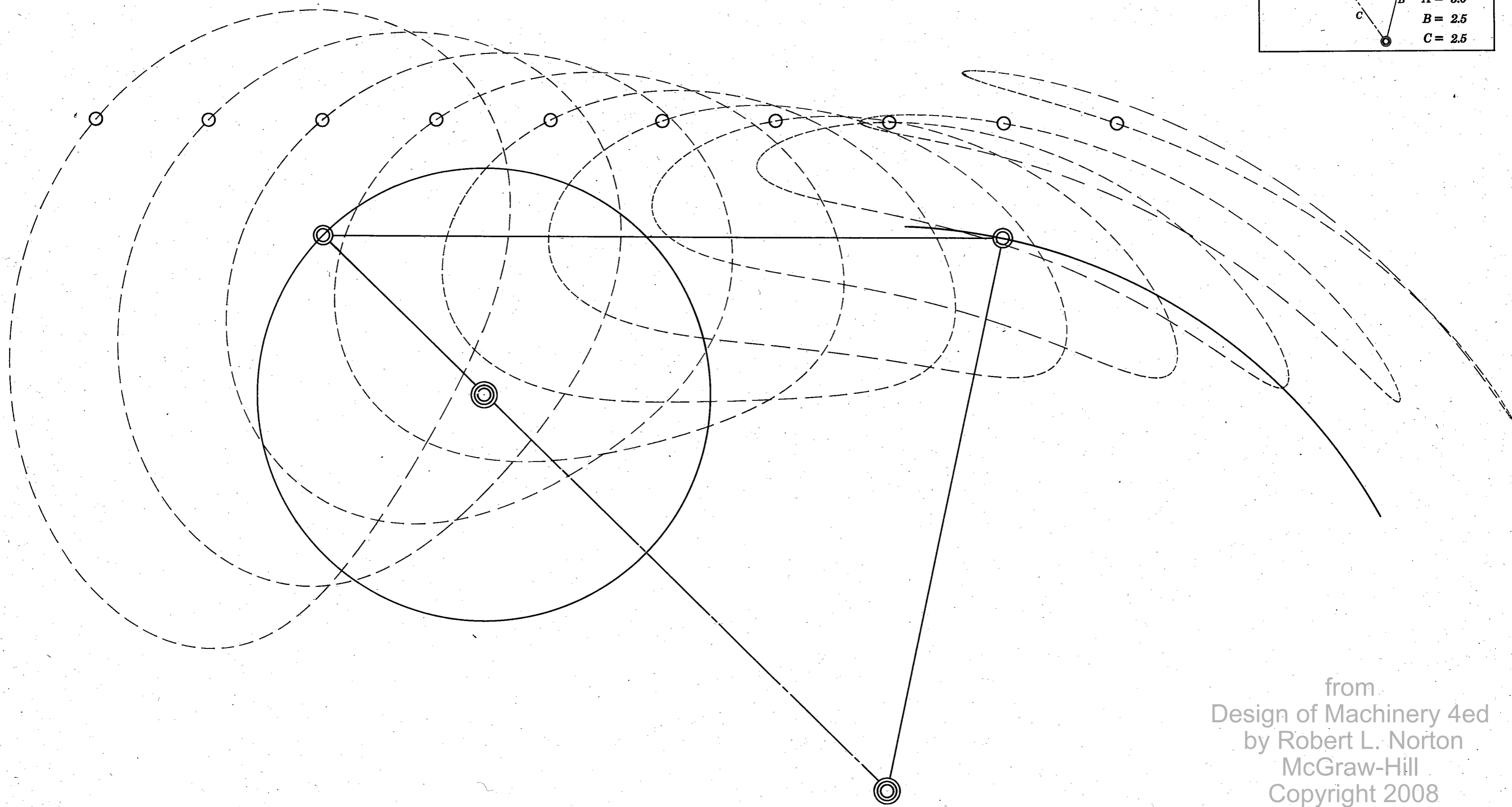

from  
 Design of Machinery 4ed  
 by Robert L. Norton  
 McGraw-Hill  
 Copyright 2008



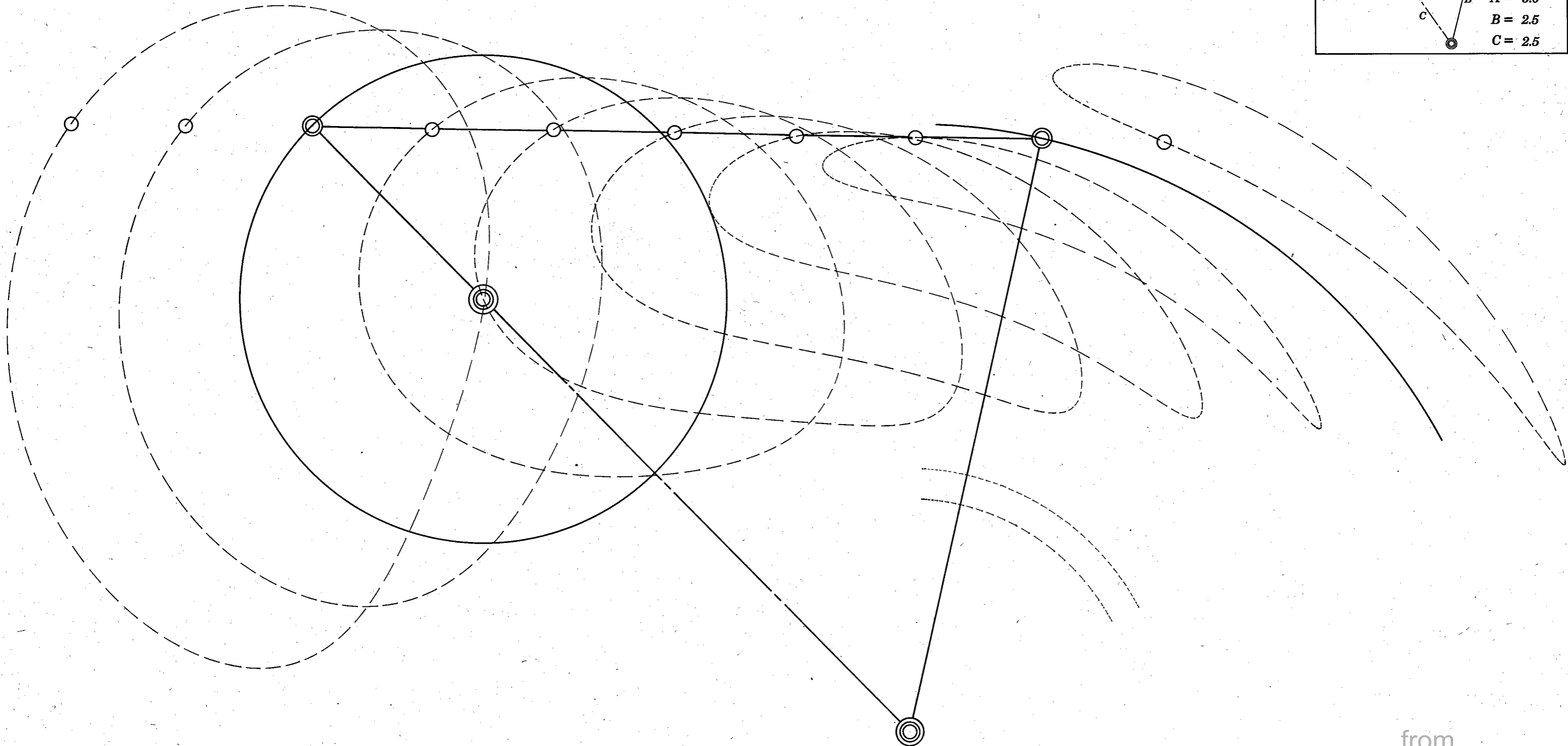
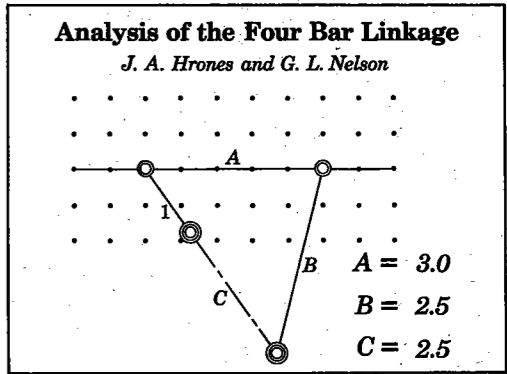

from  
Design of Machinery 4ed  
by Robert L. Norton  
McGraw-Hill  
Copyright 2008

**Analysis of the Four Bar Linkage**

*J. A. Hrones and G. L. Nelson*

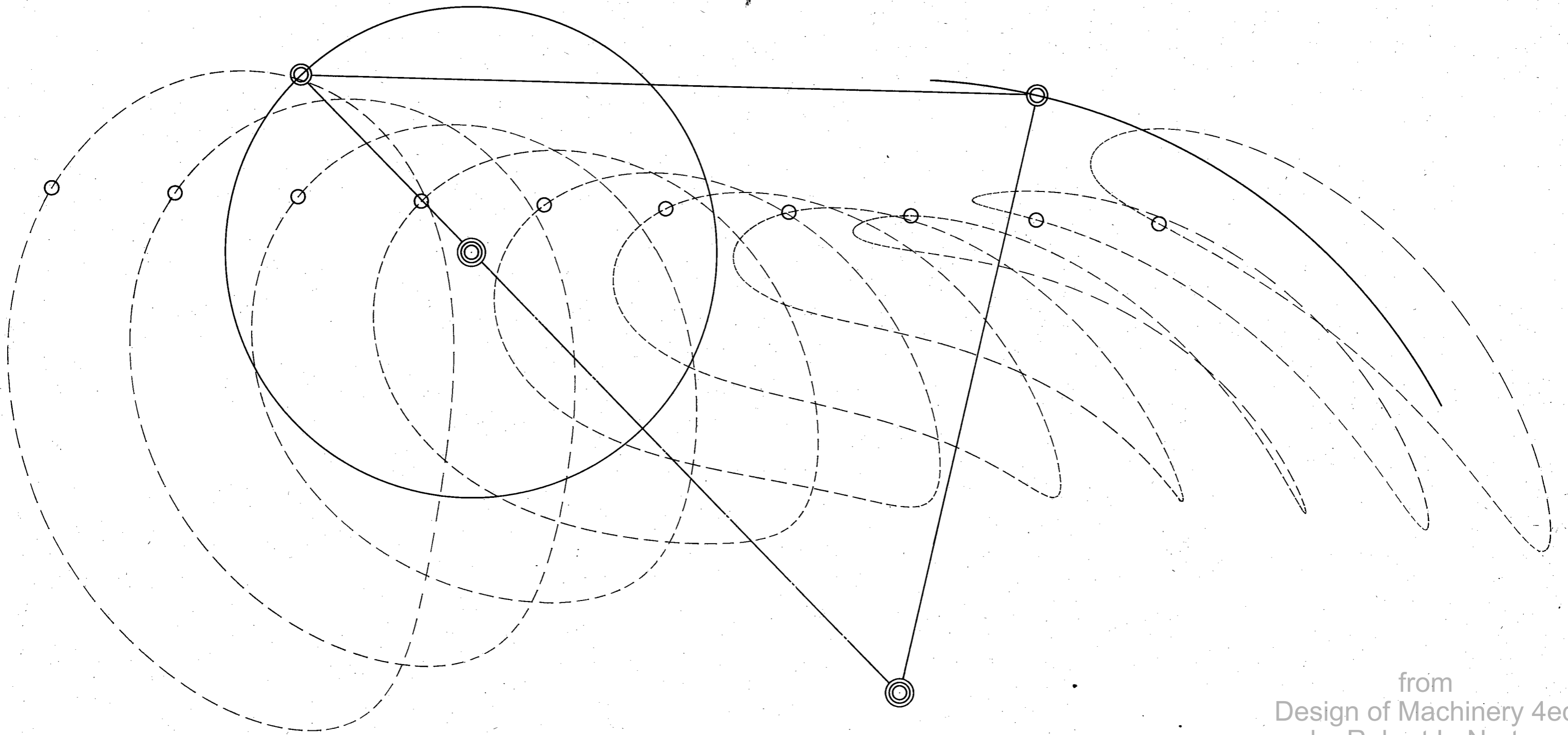
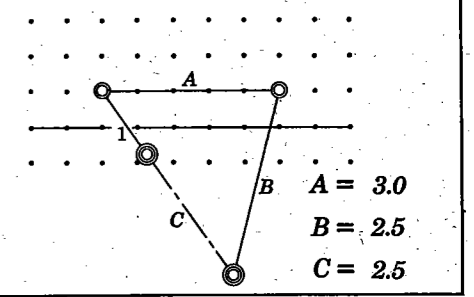

from  
Design of Machinery 4ed  
by Robert L. Norton  
McGraw-Hill  
Copyright 2008

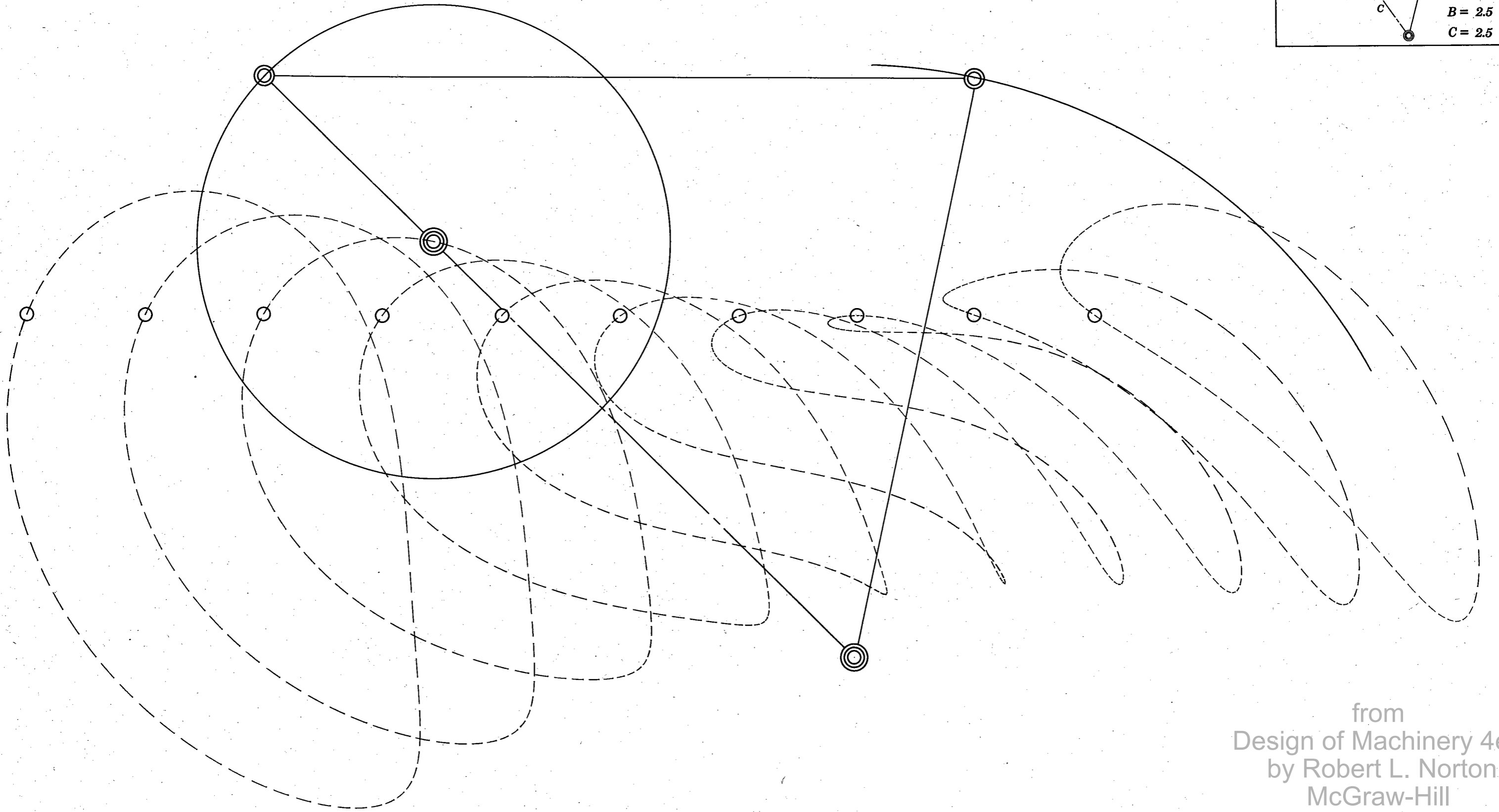
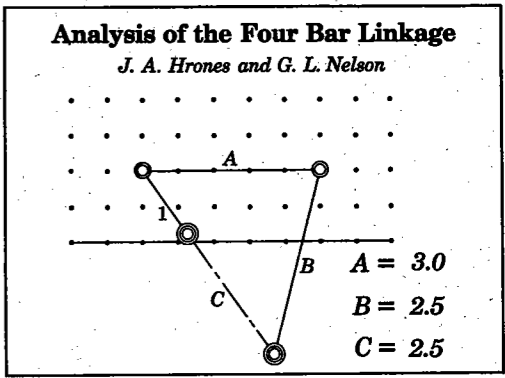

from  
Design of Machinery 4ed  
by Robert L. Norton  
McGraw-Hill  
Copyright 2008

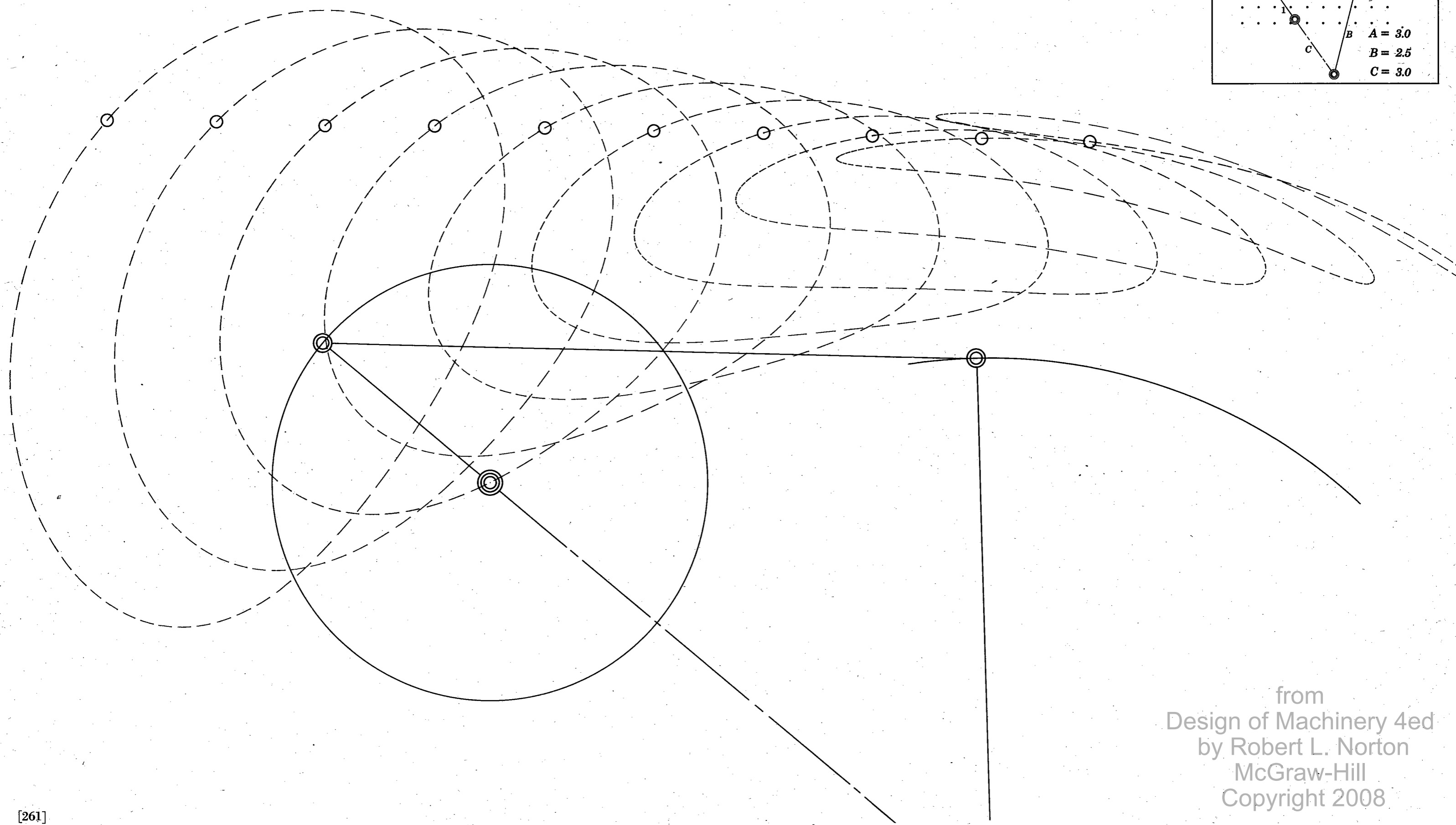
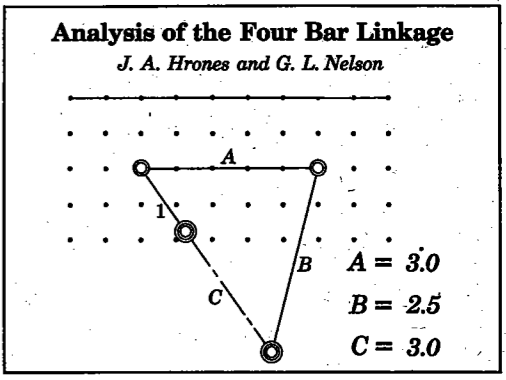

from  
 Design of Machinery 4ed  
 by Robert L. Norton  
 McGraw-Hill  
 Copyright 2008

**Analysis of the Four Bar Linkage**  
*J. A. Hrones and G. L. Nelson*

.....

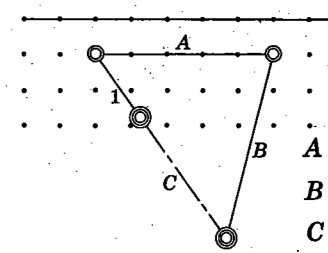

$A = 3.0$   
 $B = 2.5$   
 $C = 3.0$

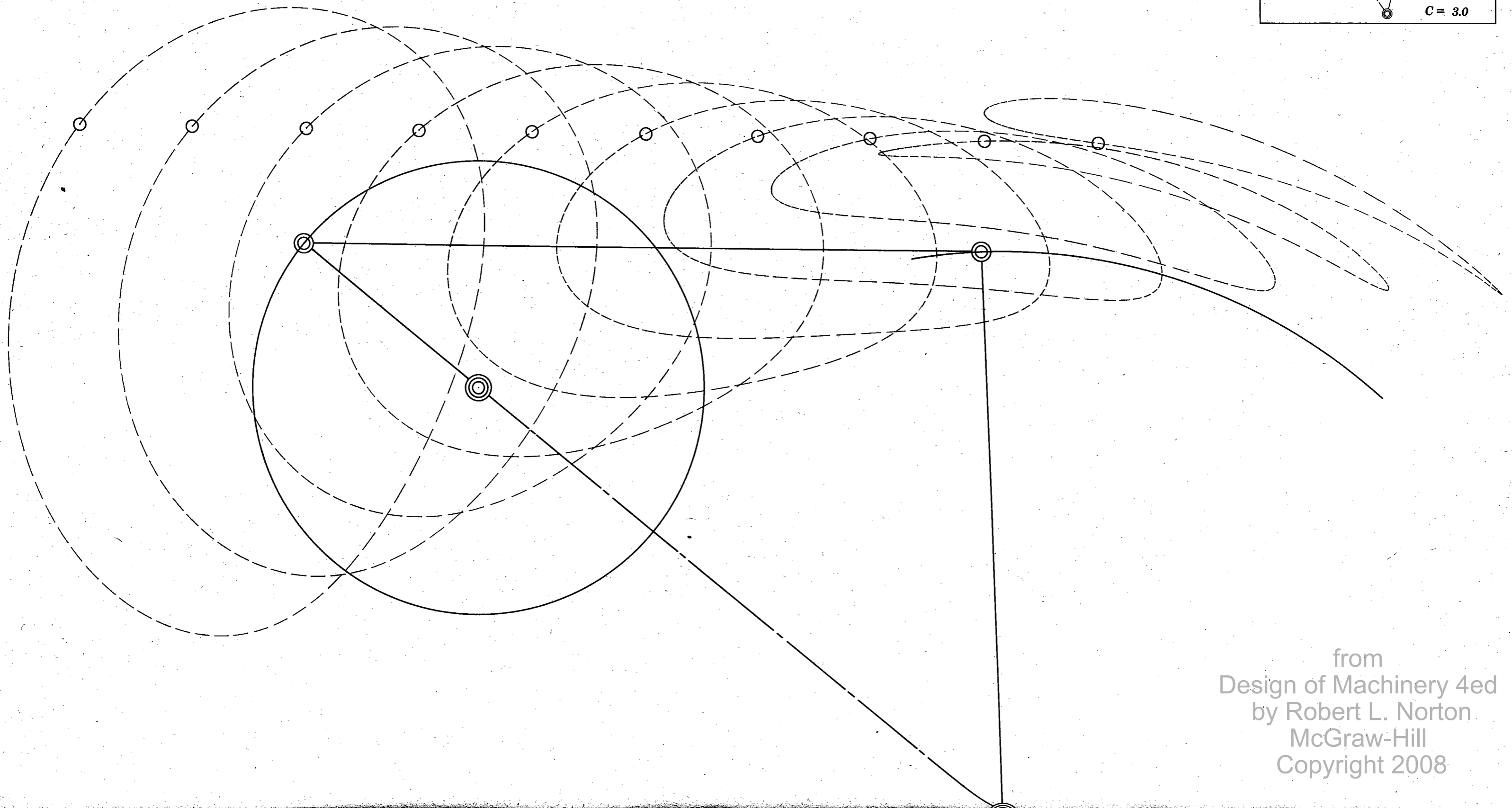

from  
Design of Machinery 4ed  
by Robert L. Norton  
McGraw-Hill  
Copyright 2008

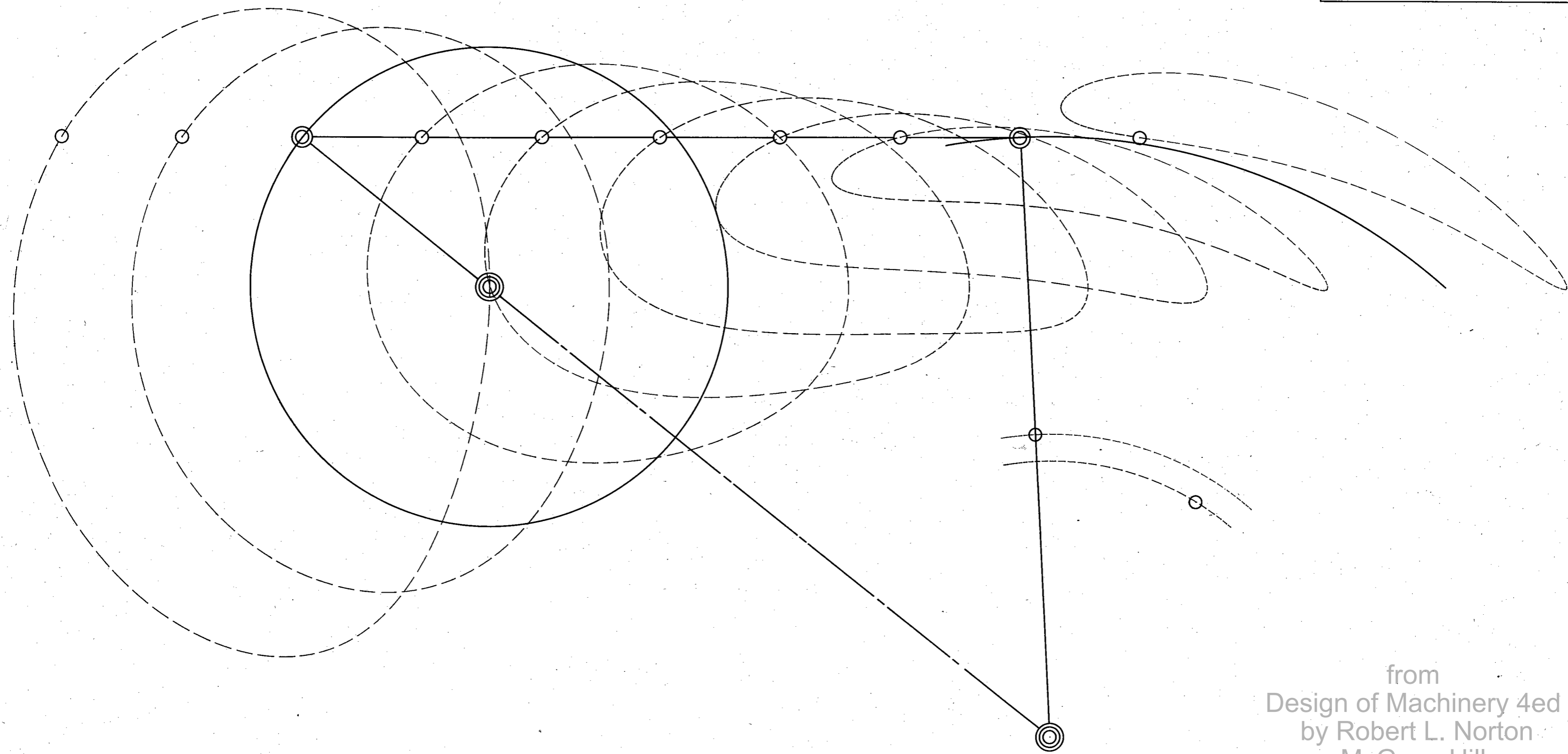
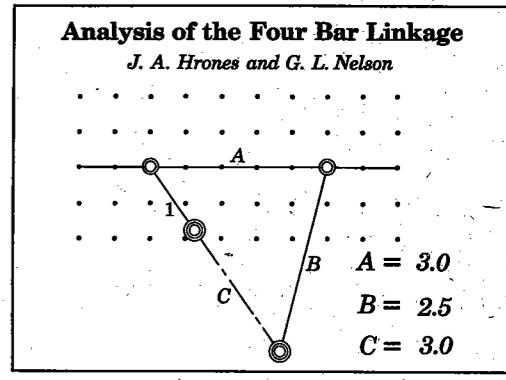

from  
 Design of Machinery 4ed  
 by Robert L. Norton  
 McGraw-Hill  
 Copyright 2008

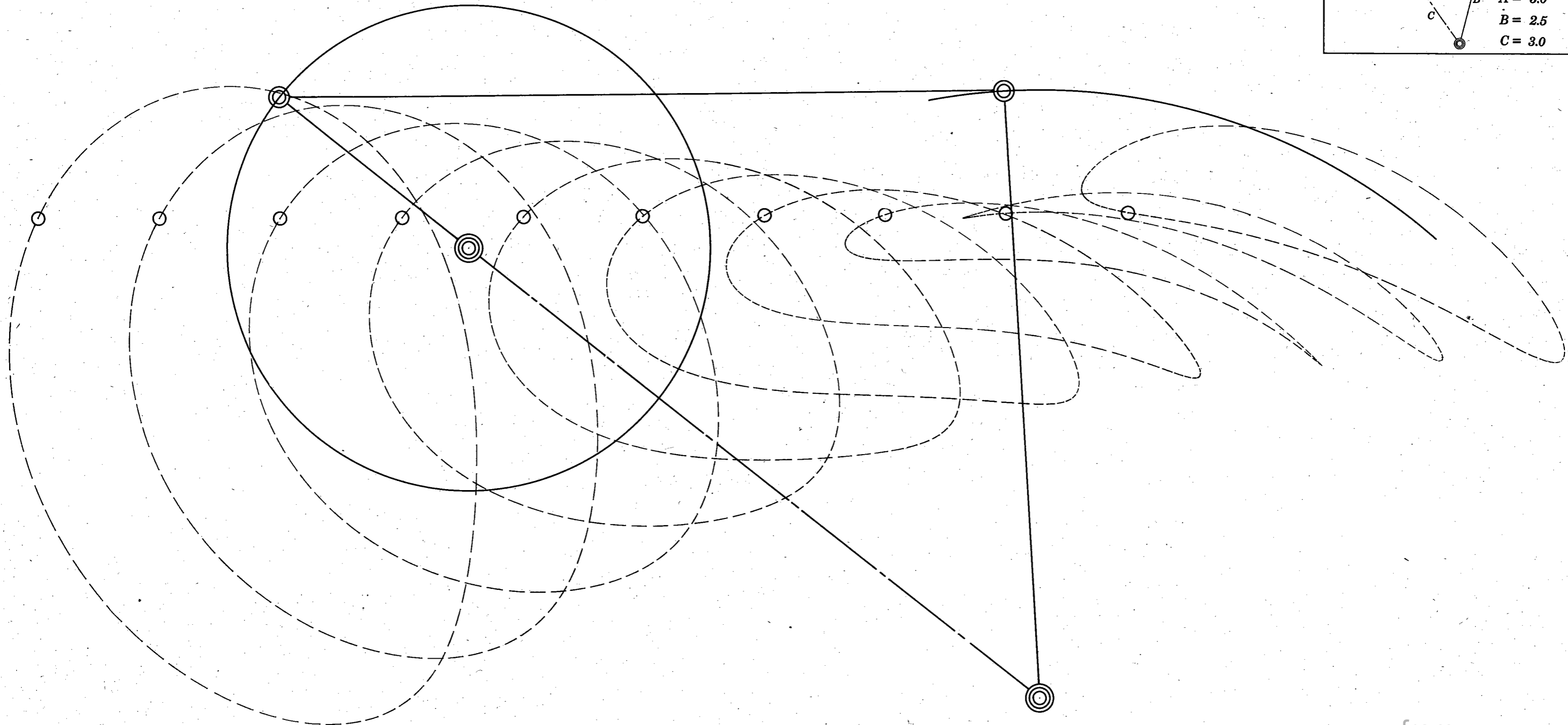
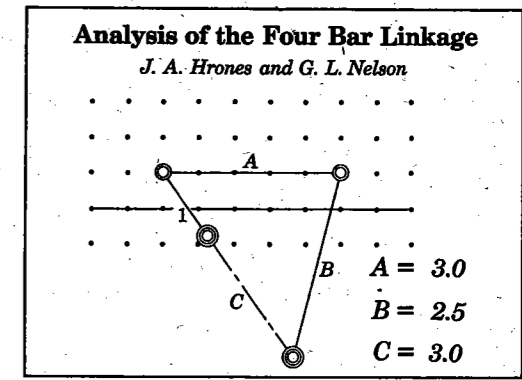

from  
Design of Machinery 4ed  
by Robert L. Norton  
McGraw-Hill  
Copyright 2008

**Analysis of the Four Bar Linkage**

*J. A. Hrones and G. L. Nelson*

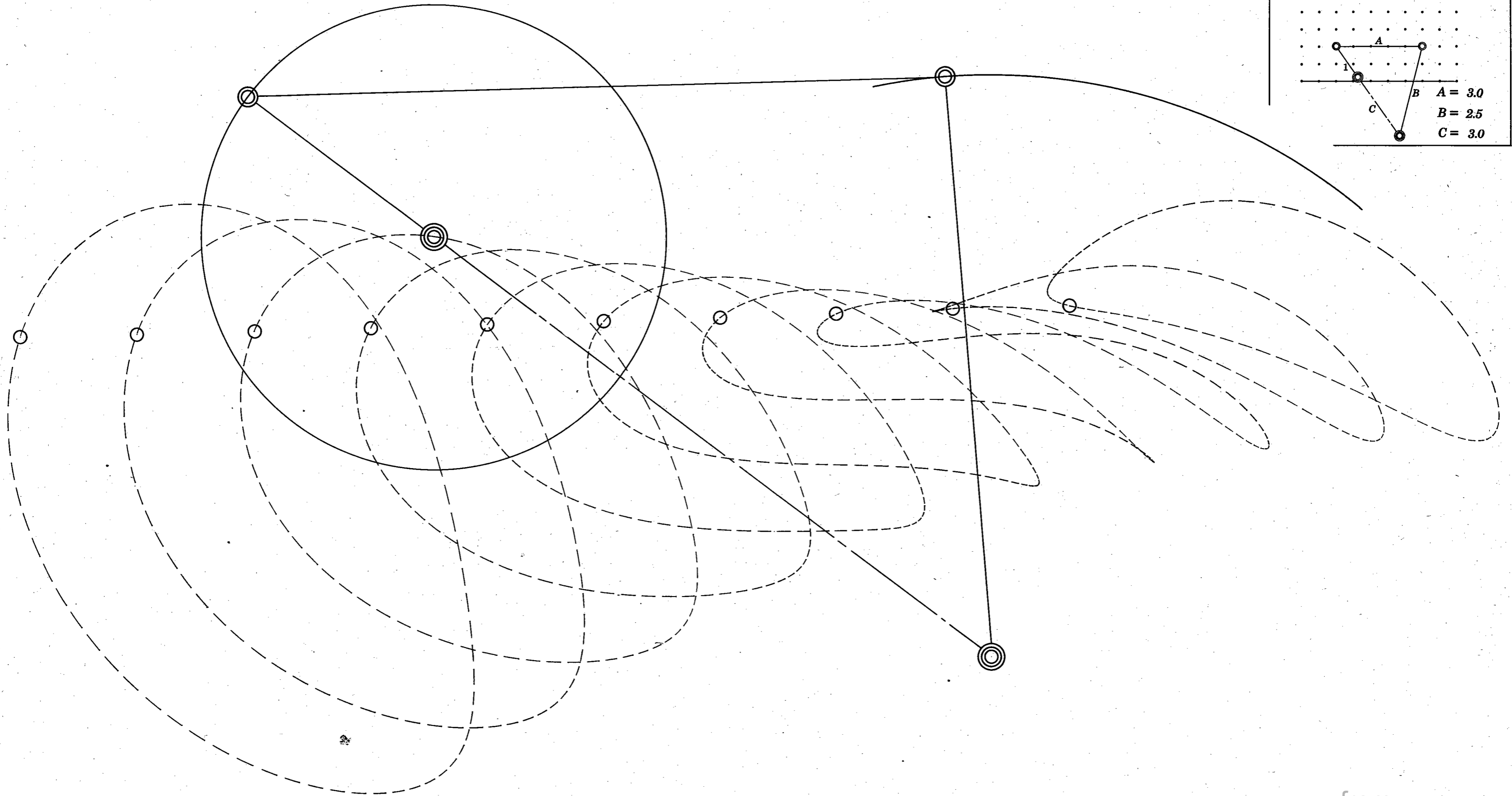
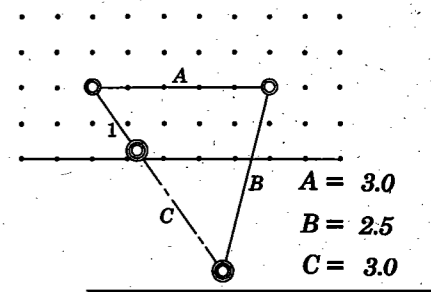

from  
Design of Machinery 4ed  
by Robert L. Norton  
McGraw-Hill  
Copyright 2008



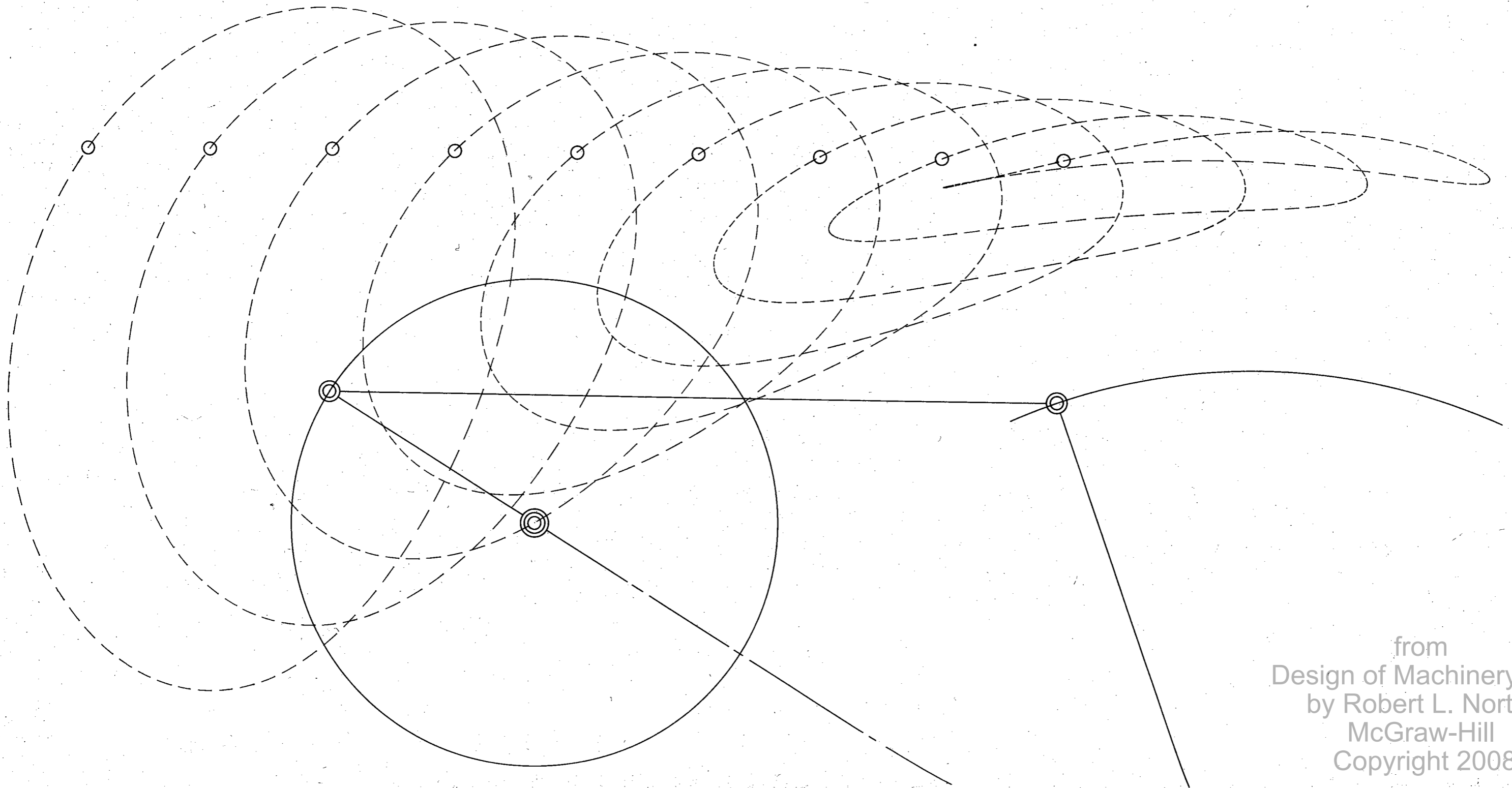
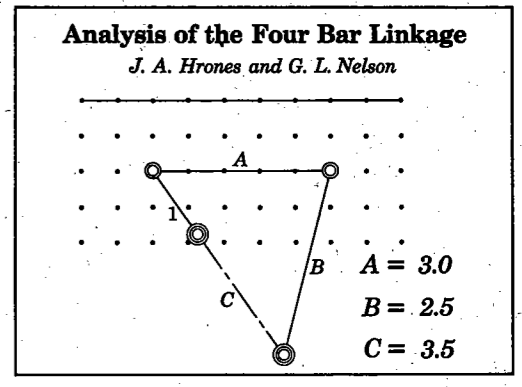

from  
Design of Machinery 4ed  
by Robert L. Norton  
McGraw-Hill  
Copyright 2008

**Analysis of the Four Bar Linkage**  
*J. A. Hrones and G. L. Nelson*

$A = 3.0$   
 $B = 2.5$   
 $C = 3.5$

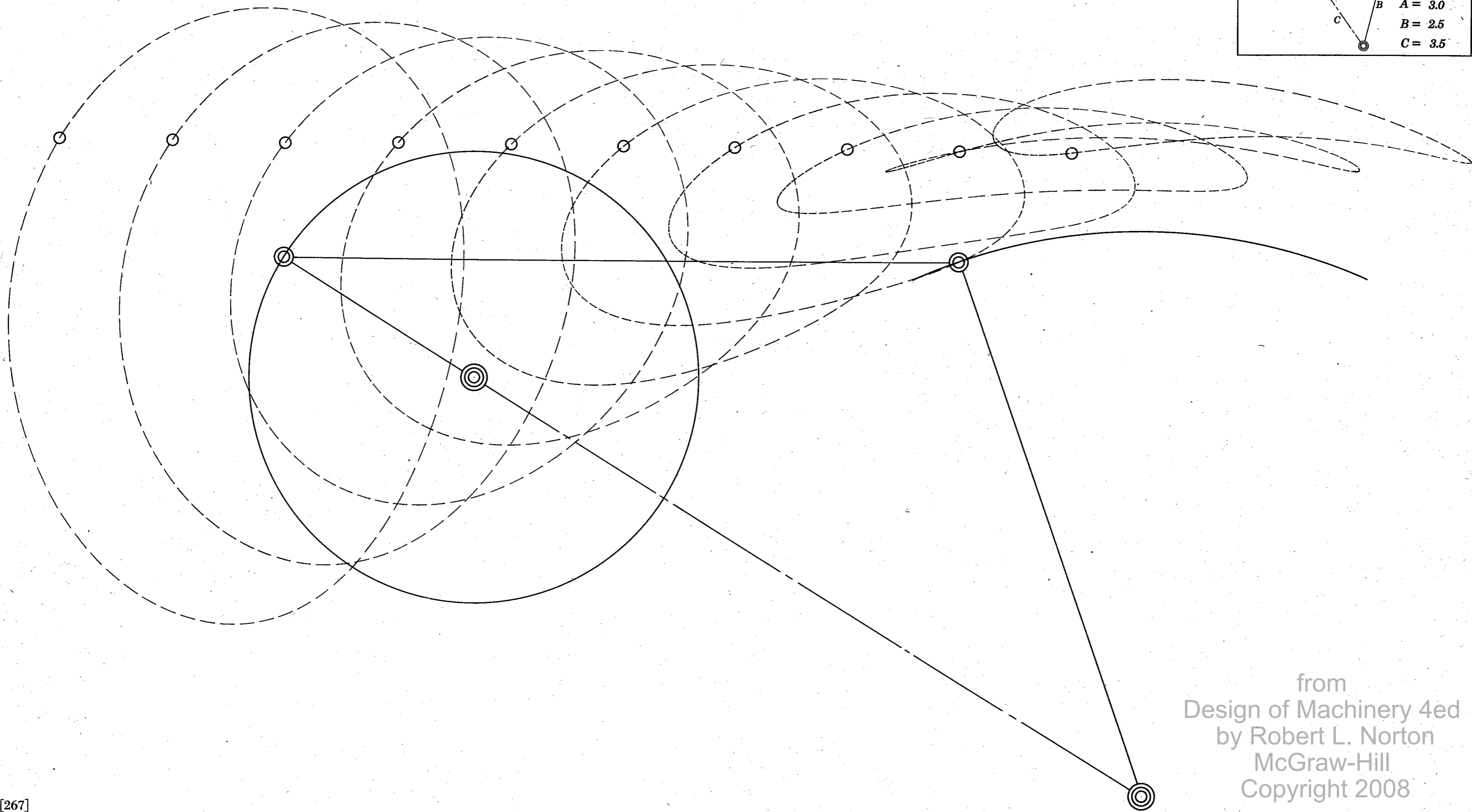

from  
 Design of Machinery 4ed  
 by Robert L. Norton  
 McGraw-Hill  
 Copyright 2008

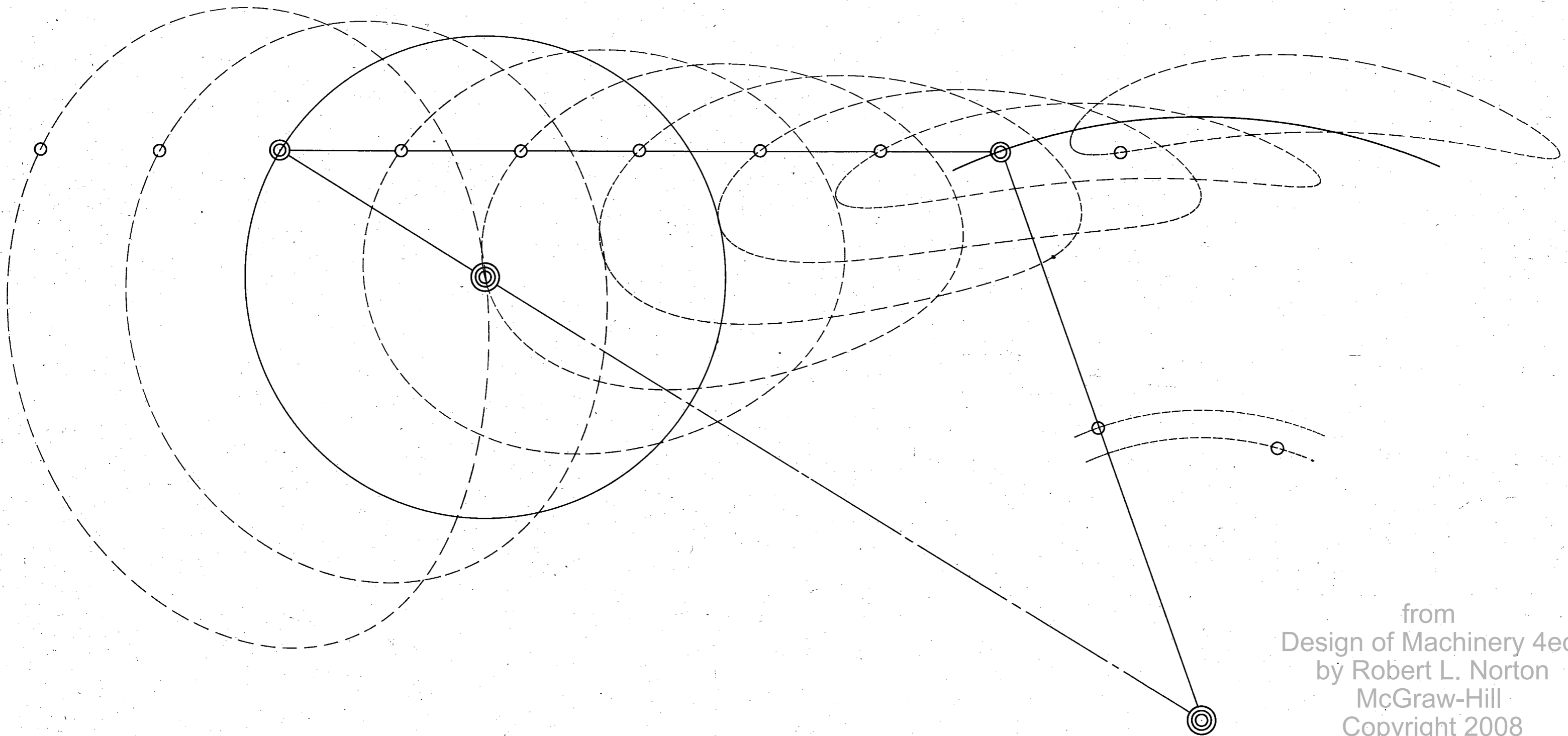
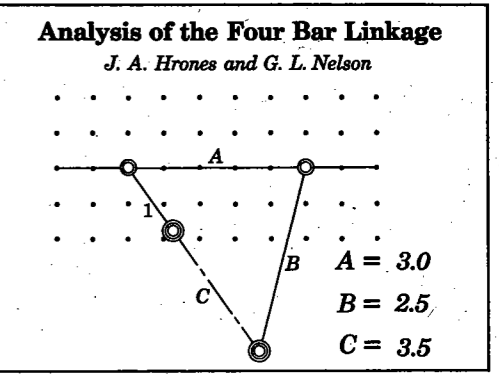

from  
Design of Machinery 4ed  
by Robert L. Norton  
McGraw-Hill  
Copyright 2008

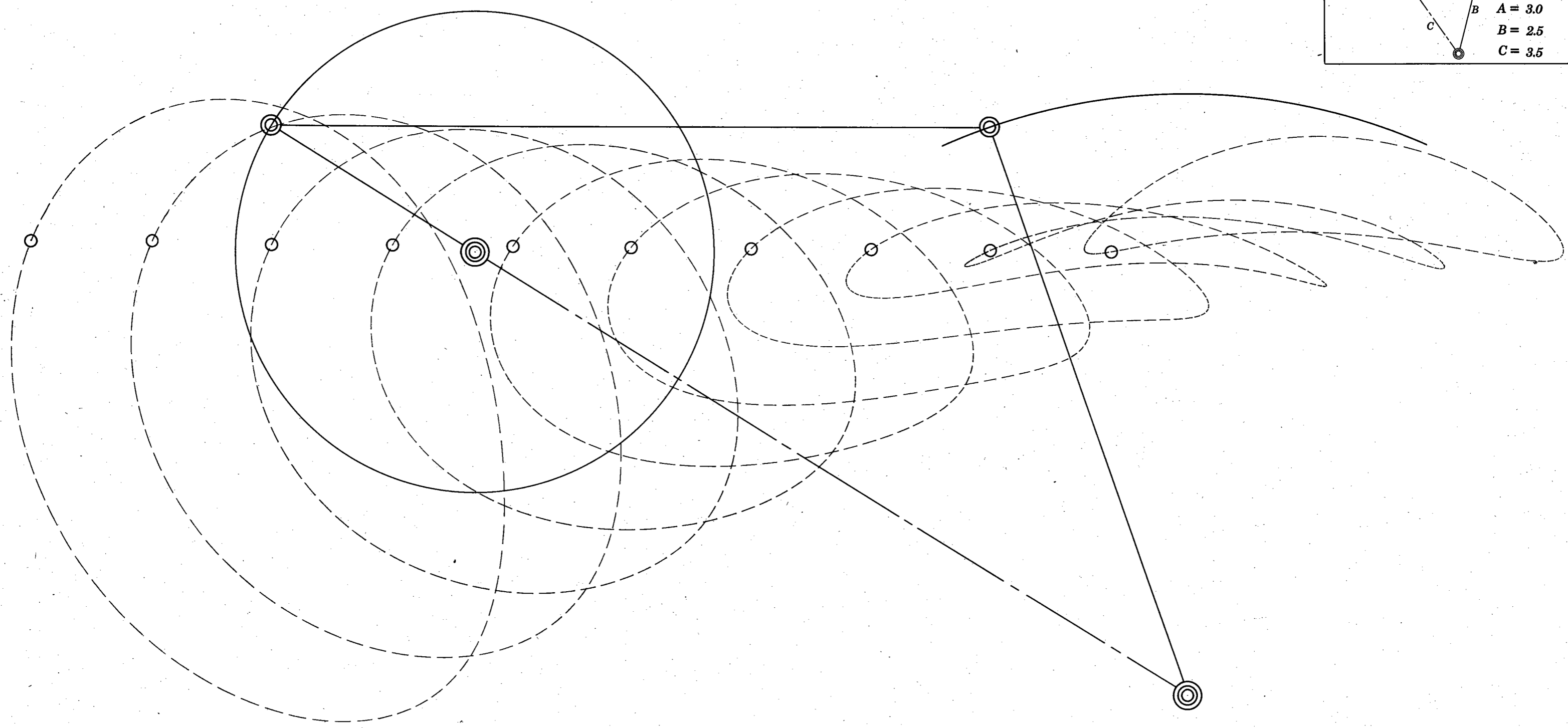
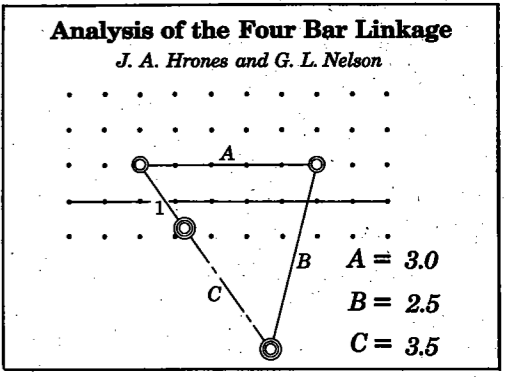

from  
 Design of Machinery 4ed  
 by Robert L. Norton  
 McGraw-Hill  
 Copyright 2008

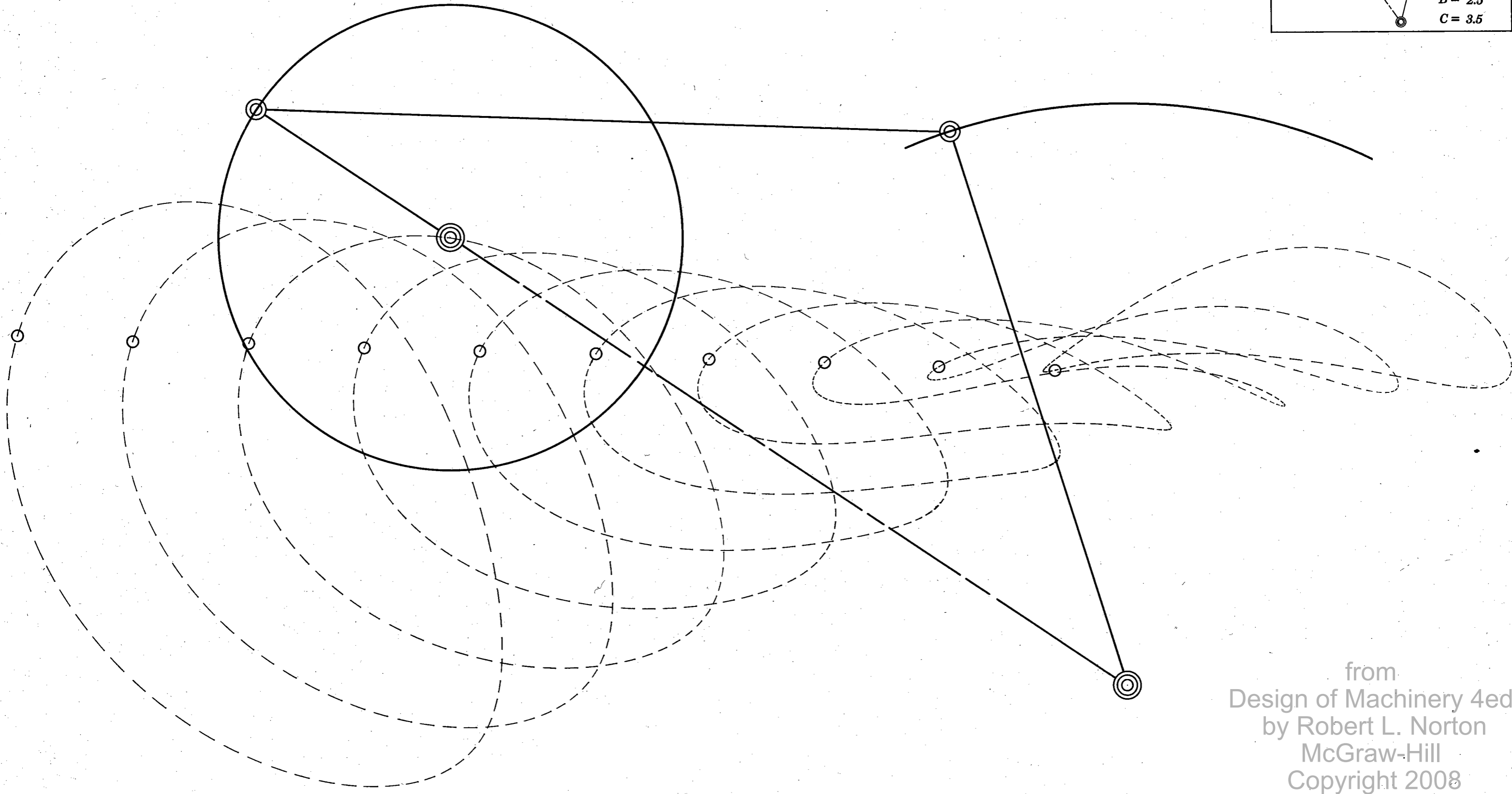
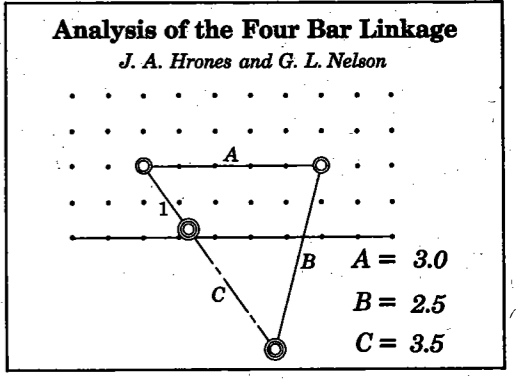

from  
Design of Machinery 4ed  
by Robert L. Norton  
McGraw-Hill  
Copyright 2008

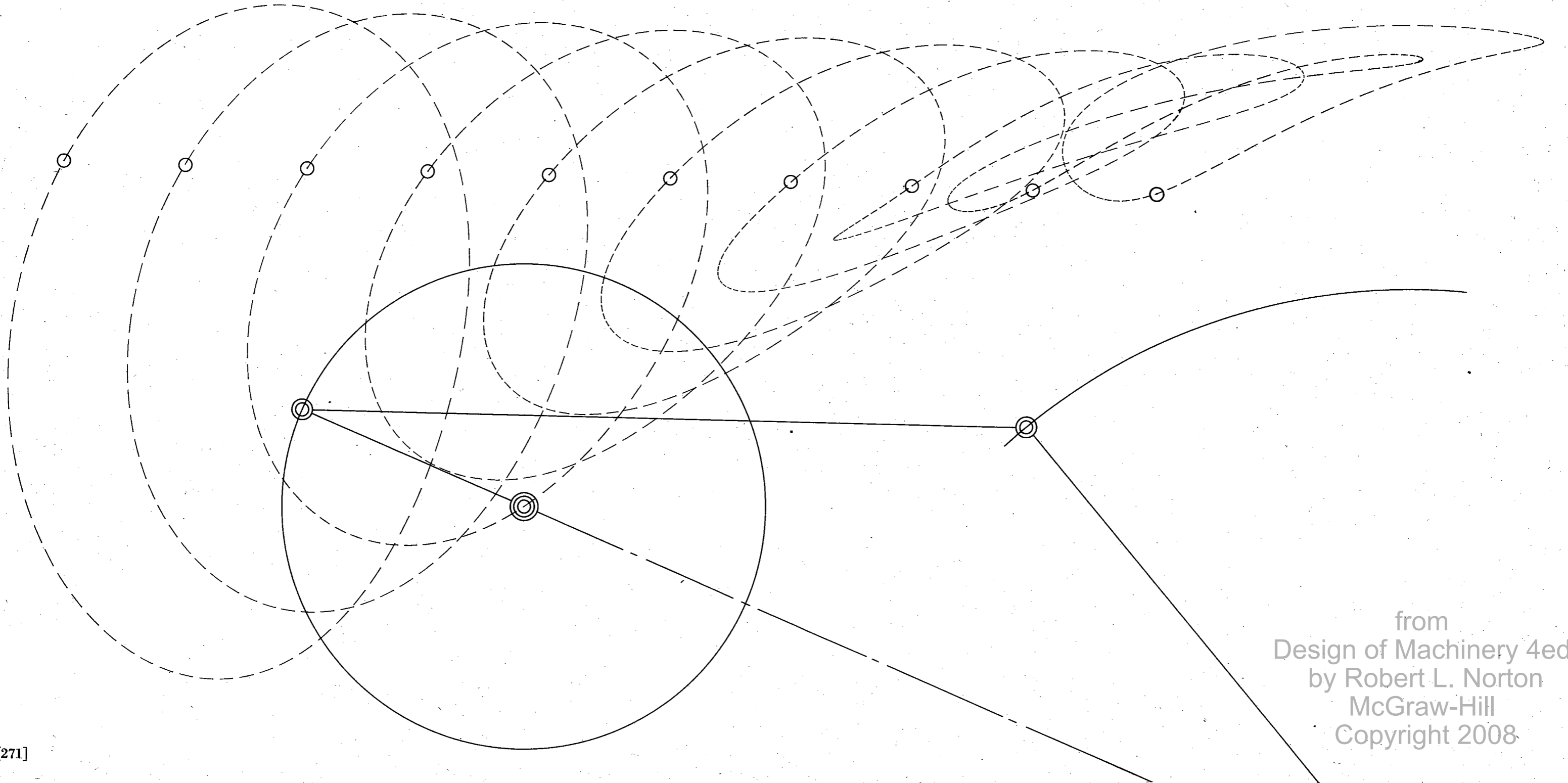
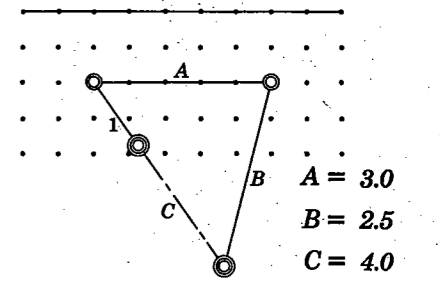

from  
Design of Machinery 4ed  
by Robert L. Norton  
McGraw-Hill  
Copyright 2008

**Analysis of the Four Bar Linkage**  
*J. A. Hrones and G. L. Nelson*

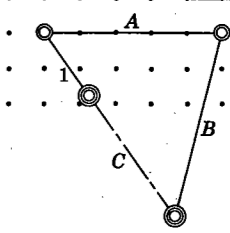

$A = 3.0$   
 $B = 2.5$   
 $C = 4.0$

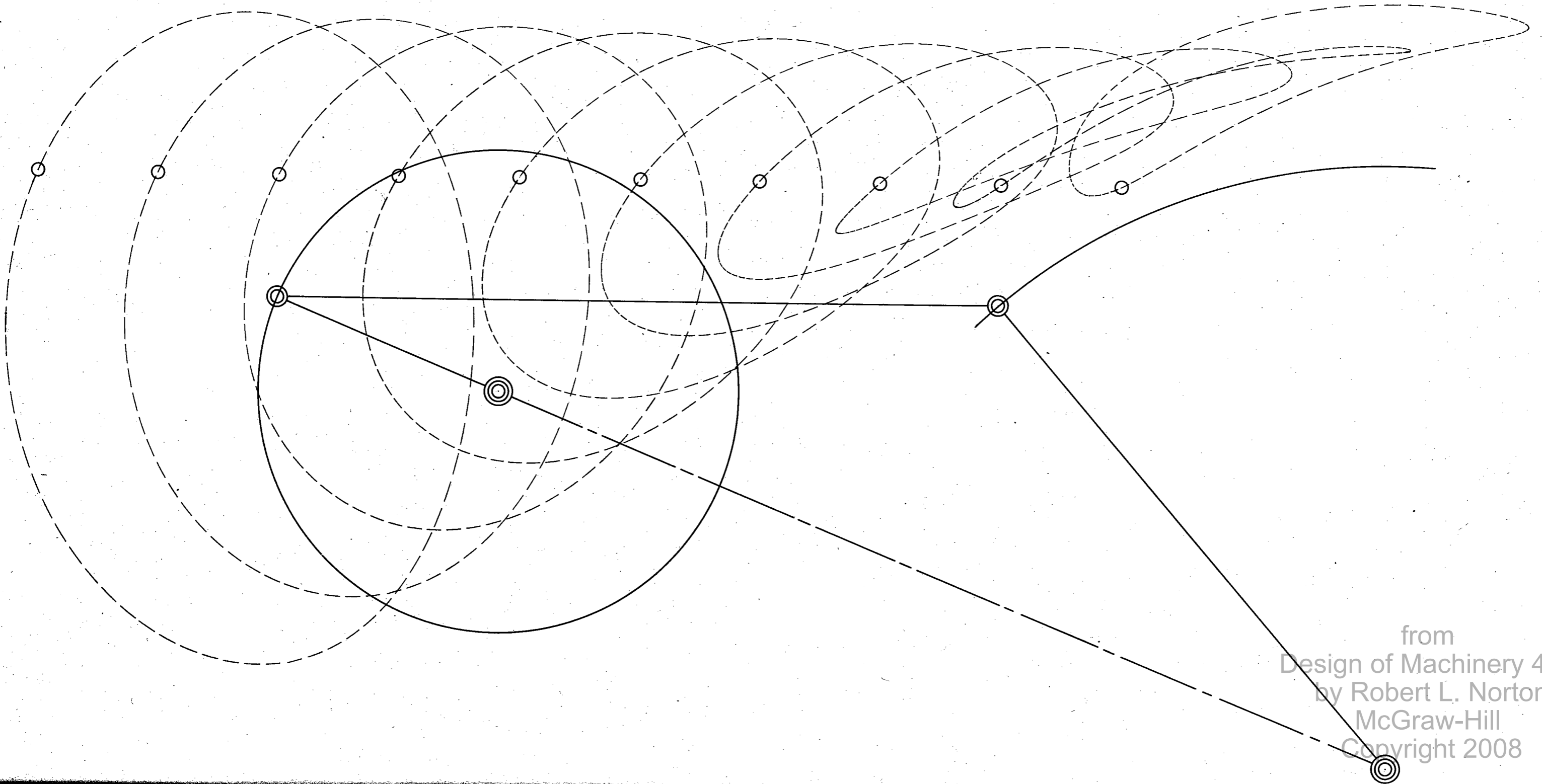

from  
Design of Machinery 4ed  
by Robert L. Norton  
McGraw-Hill  
Copyright 2008

**Analysis of the Four Bar Linkage**  
*J. A. Hrones and G. L. Nelson*

A = 3.0  
 B = 2.5  
 C = 4.0

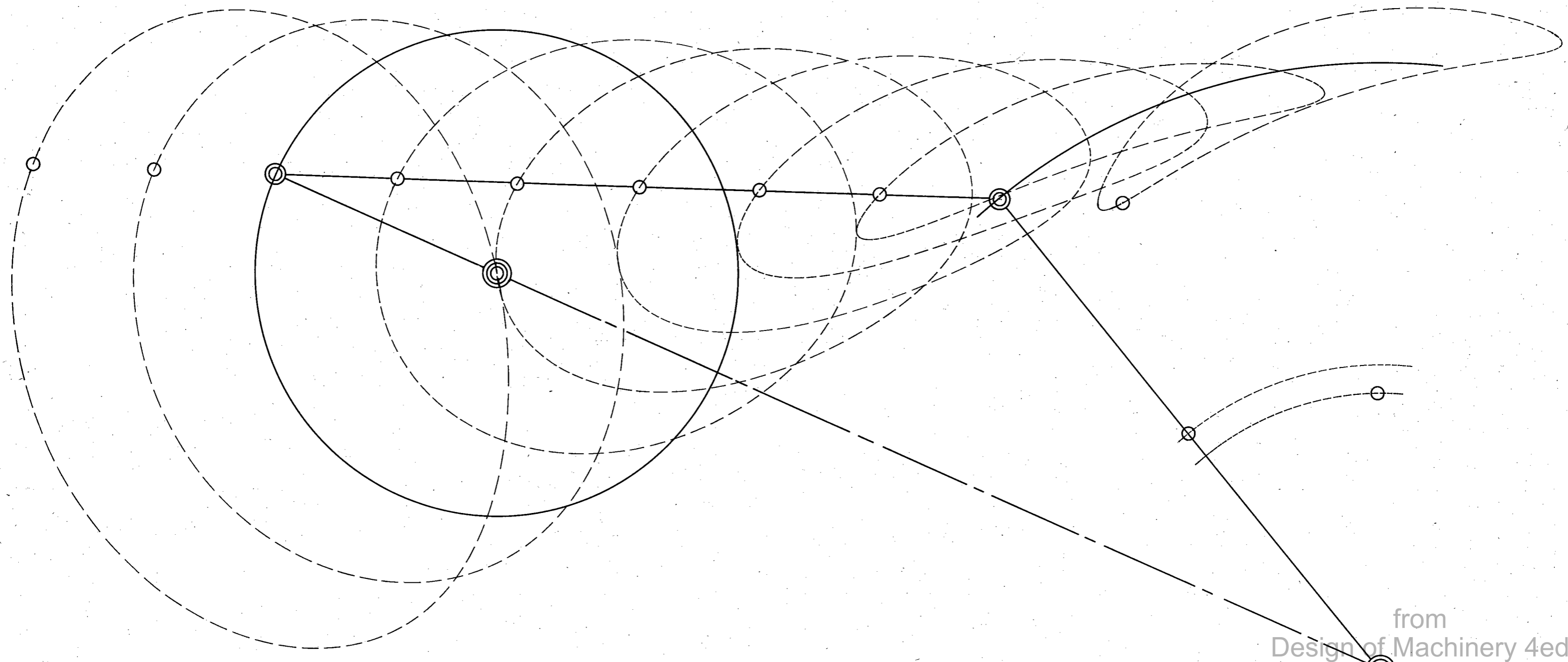

from  
 Design of Machinery 4ed  
 by Robert L. Norton  
 McGraw-Hill  
 Copyright 2008



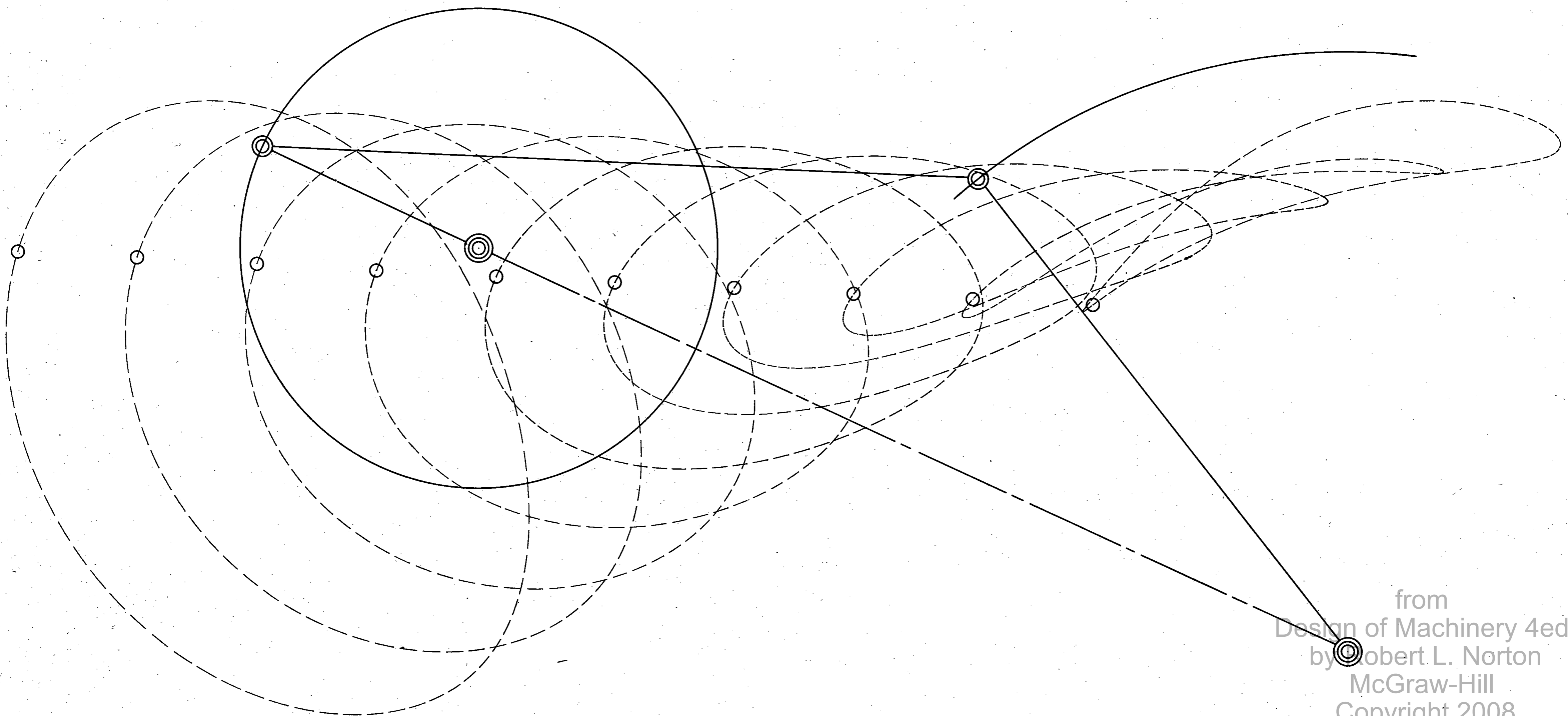
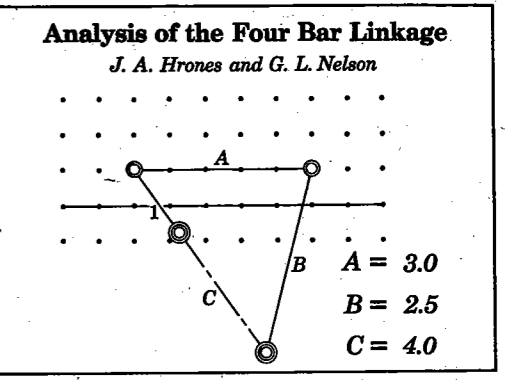

from  
Design of Machinery 4ed  
by © Robert L. Norton  
McGraw-Hill  
Copyright 2008

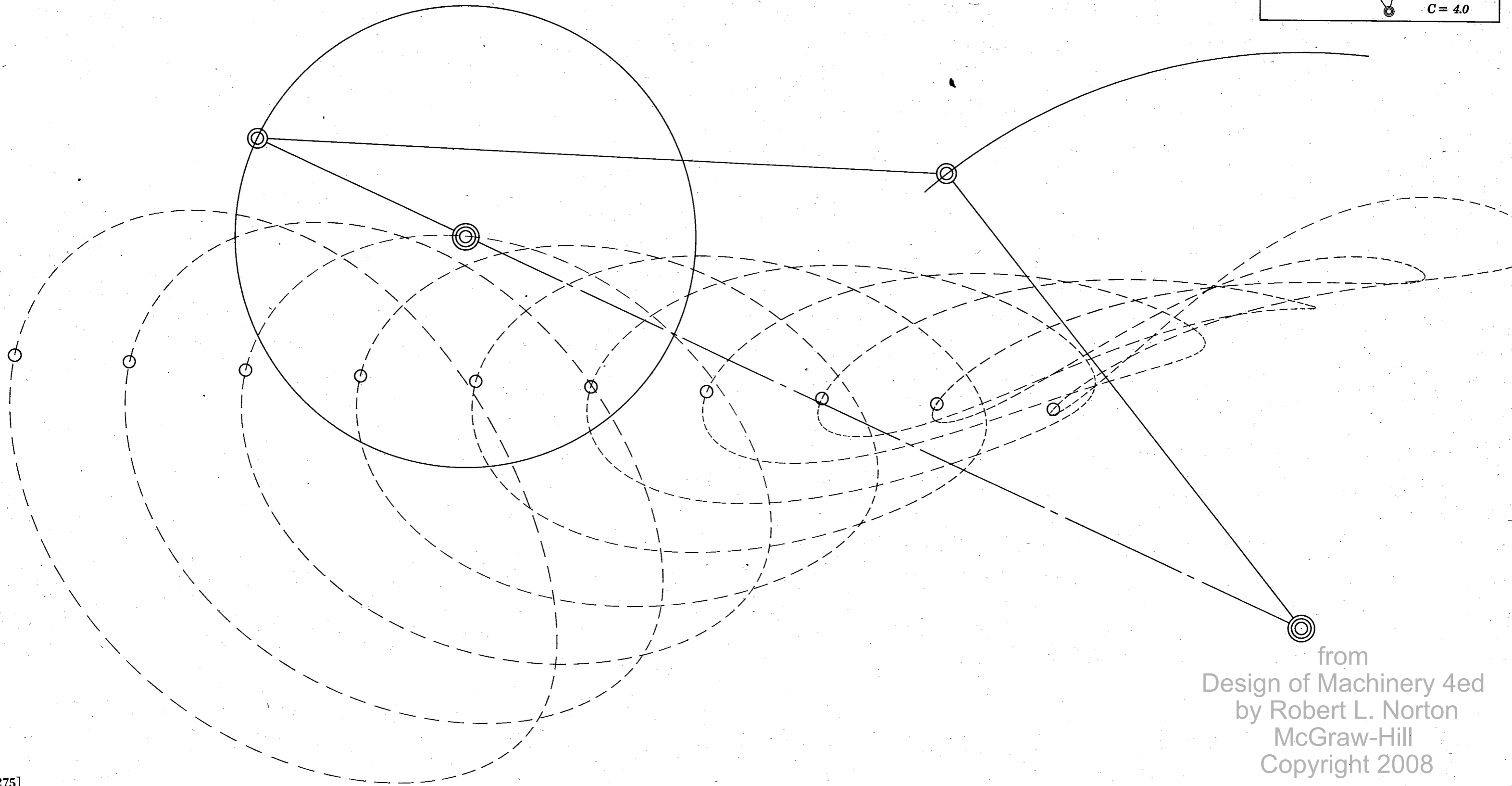
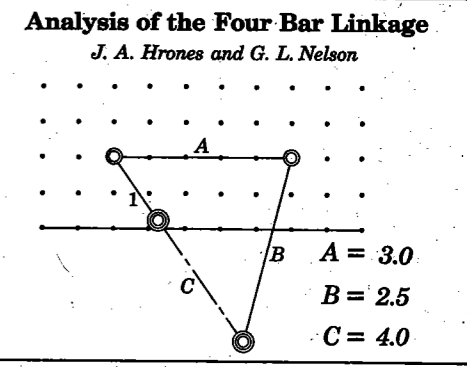

from  
 Design of Machinery 4ed  
 by Robert L. Norton  
 McGraw-Hill  
 Copyright 2008

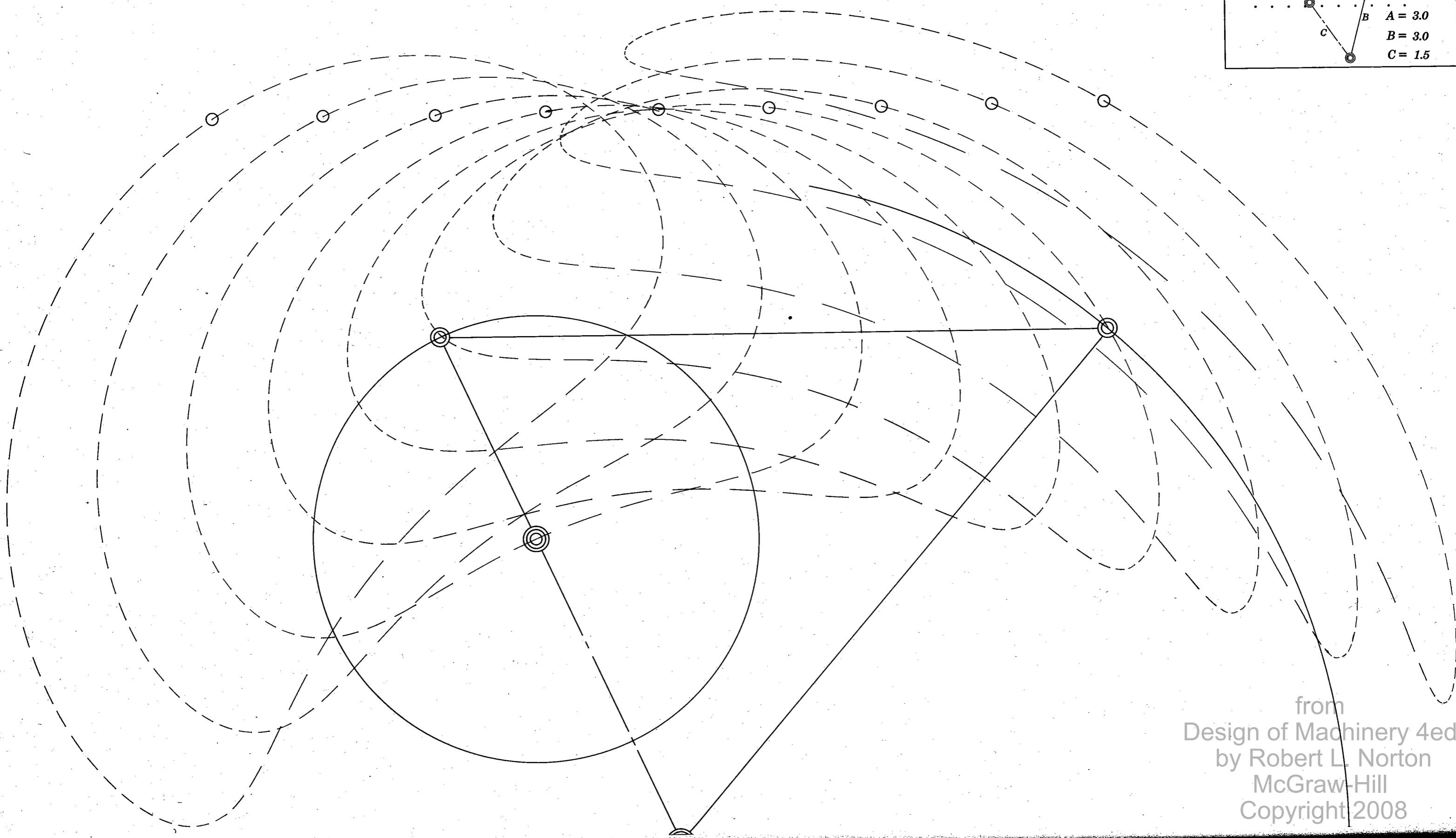
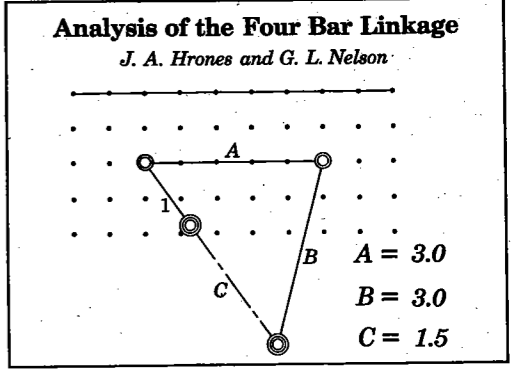

from  
Design of Machinery 4ed  
by Robert L. Norton  
McGraw-Hill  
Copyright 2008

Analysis of the Four Bar Linkage

J. A. Hrones and G. L. Nelson

.....

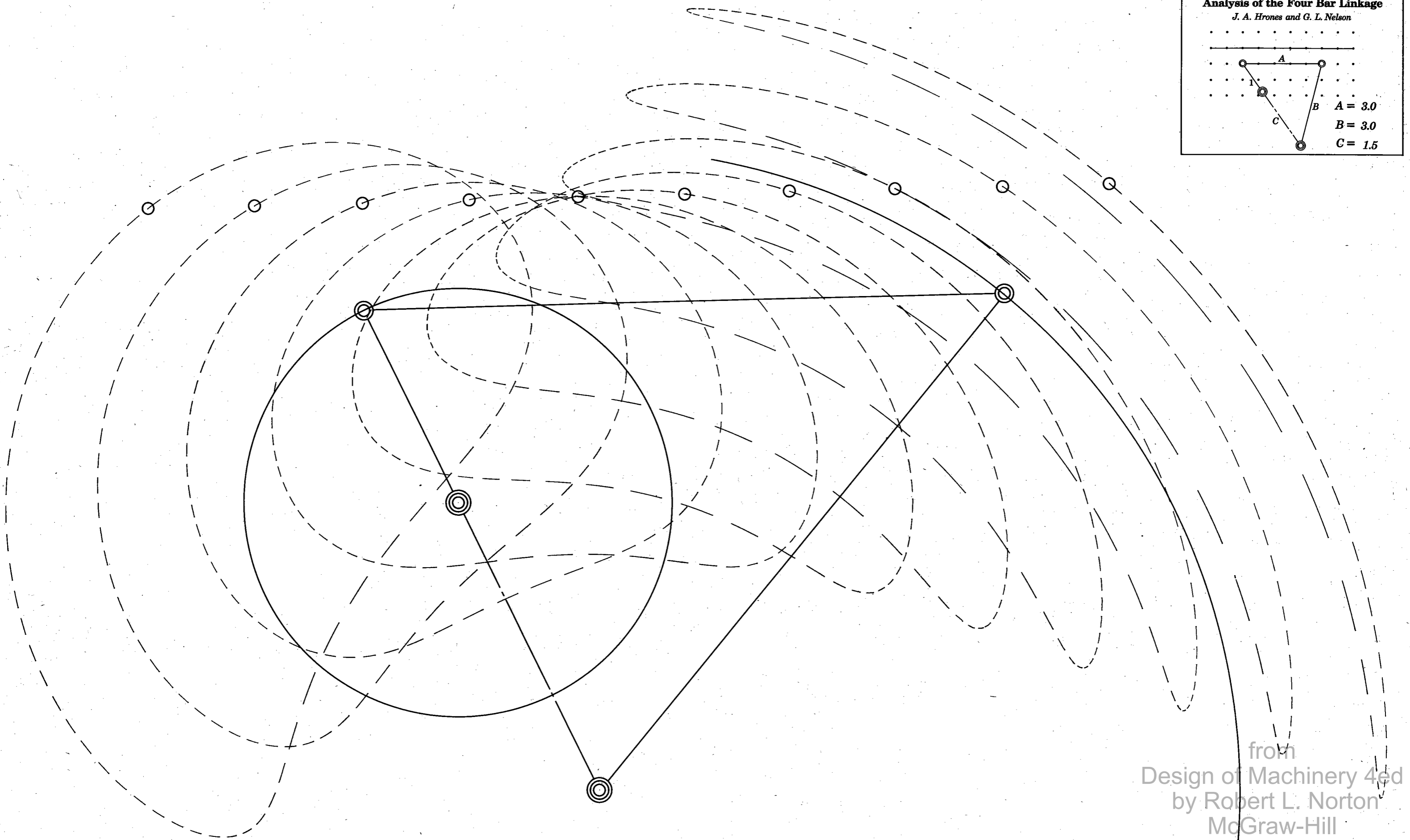
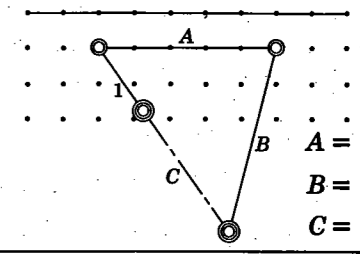

from  
Design of Machinery 4ed  
by Robert L. Norton  
McGraw-Hill  
Copyright 2008

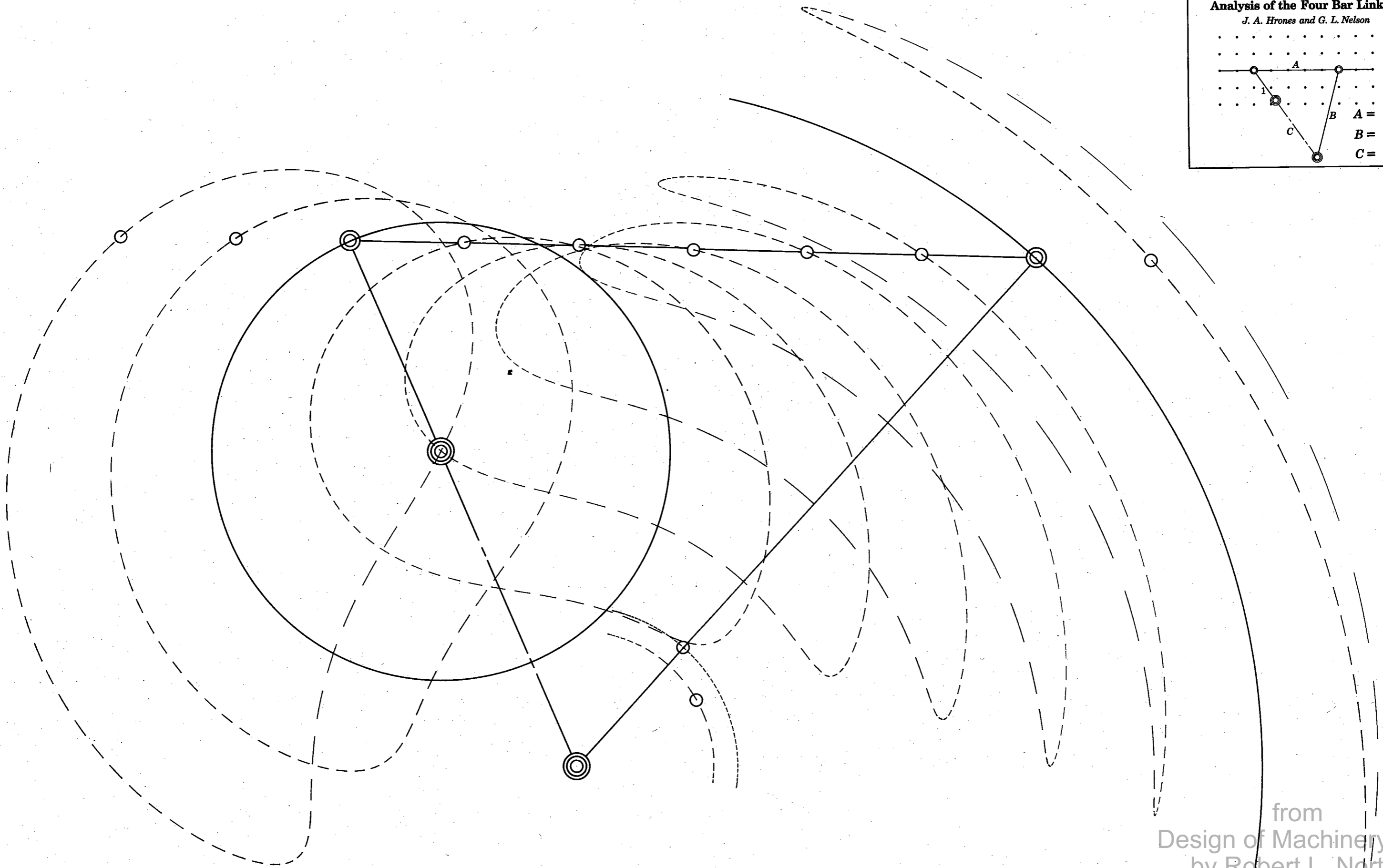
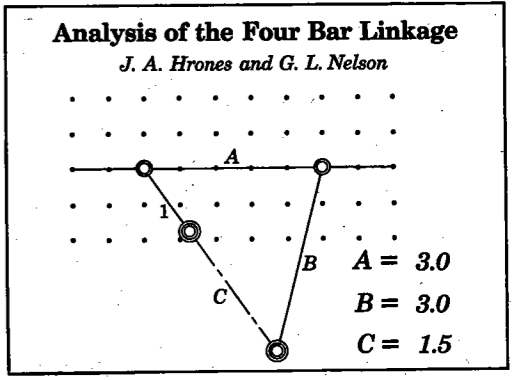

from  
Design of Machinery 4ed  
by Robert L. Norton  
McGraw-Hill  
Copyright 2008

**Analysis of the Four Bar Linkage**

*J. A. Hrones and G. L. Nelson*

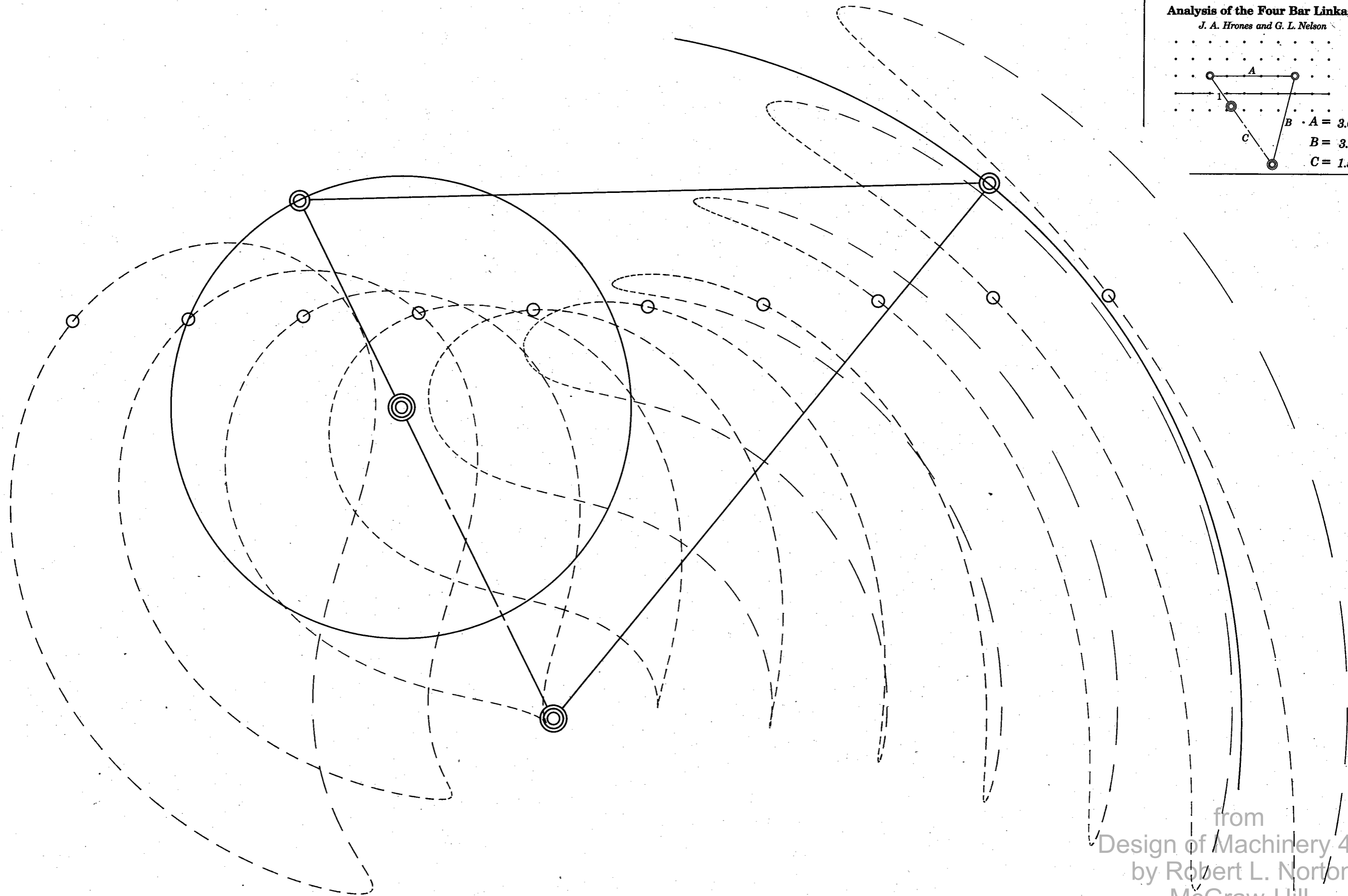
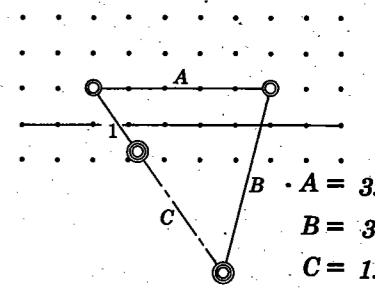

from  
Design of Machinery 4ed  
by Robert L. Norton  
McGraw-Hill  
Copyright 2008

**Analysis of the Four Bar Linkage**

*J. A. Hrones and G. L. Nelson*

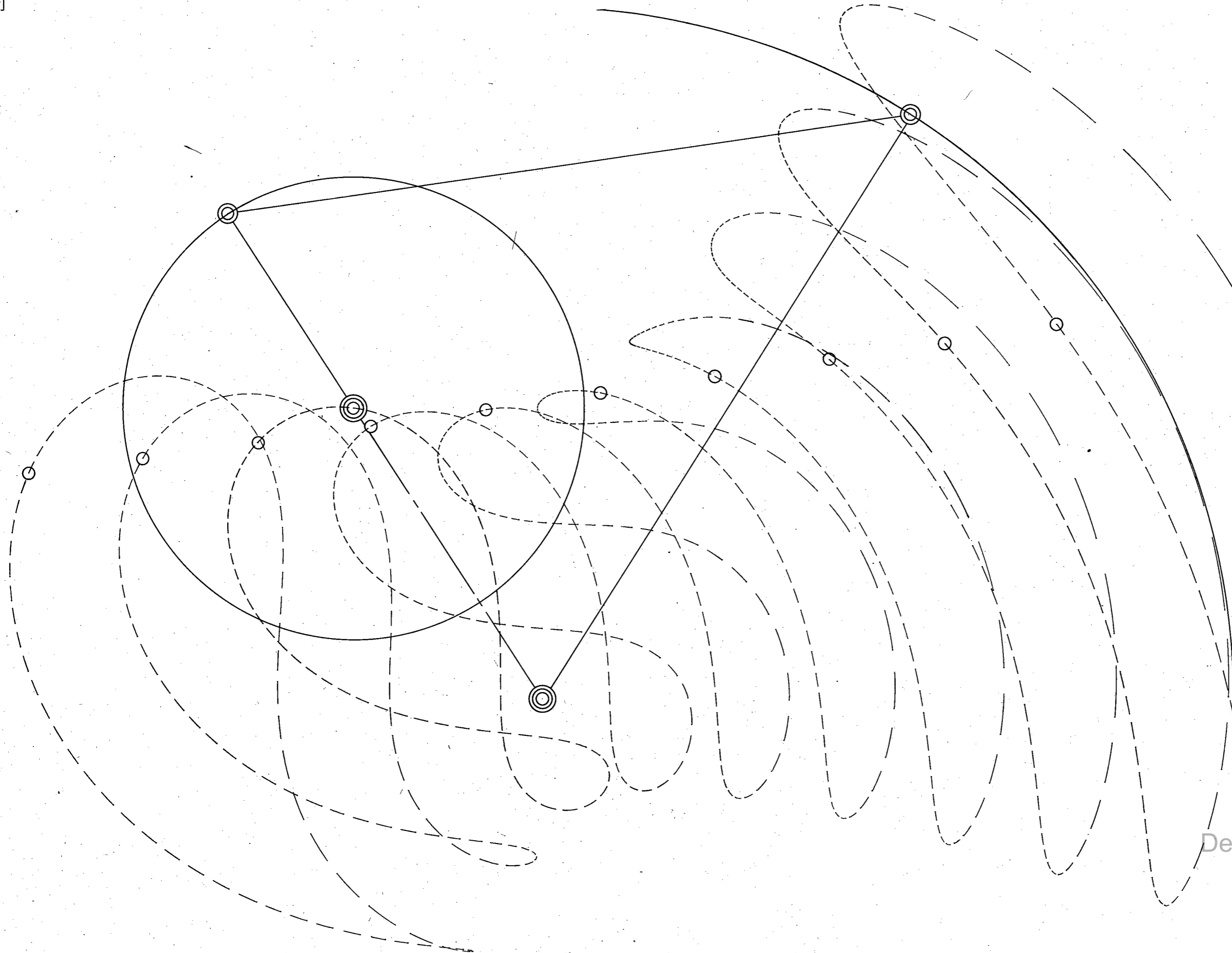
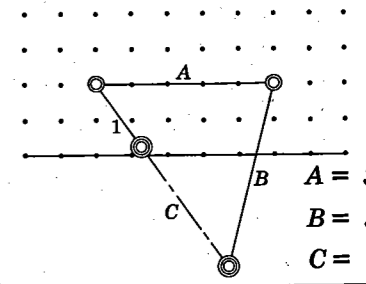

from  
Design of Machinery 4ed  
by Robert L. Norton  
McGraw-Hill  
Copyright 2008

**Analysis of the Four Bar Linkage**  
*J. A. Hrones and G. L. Nelson*

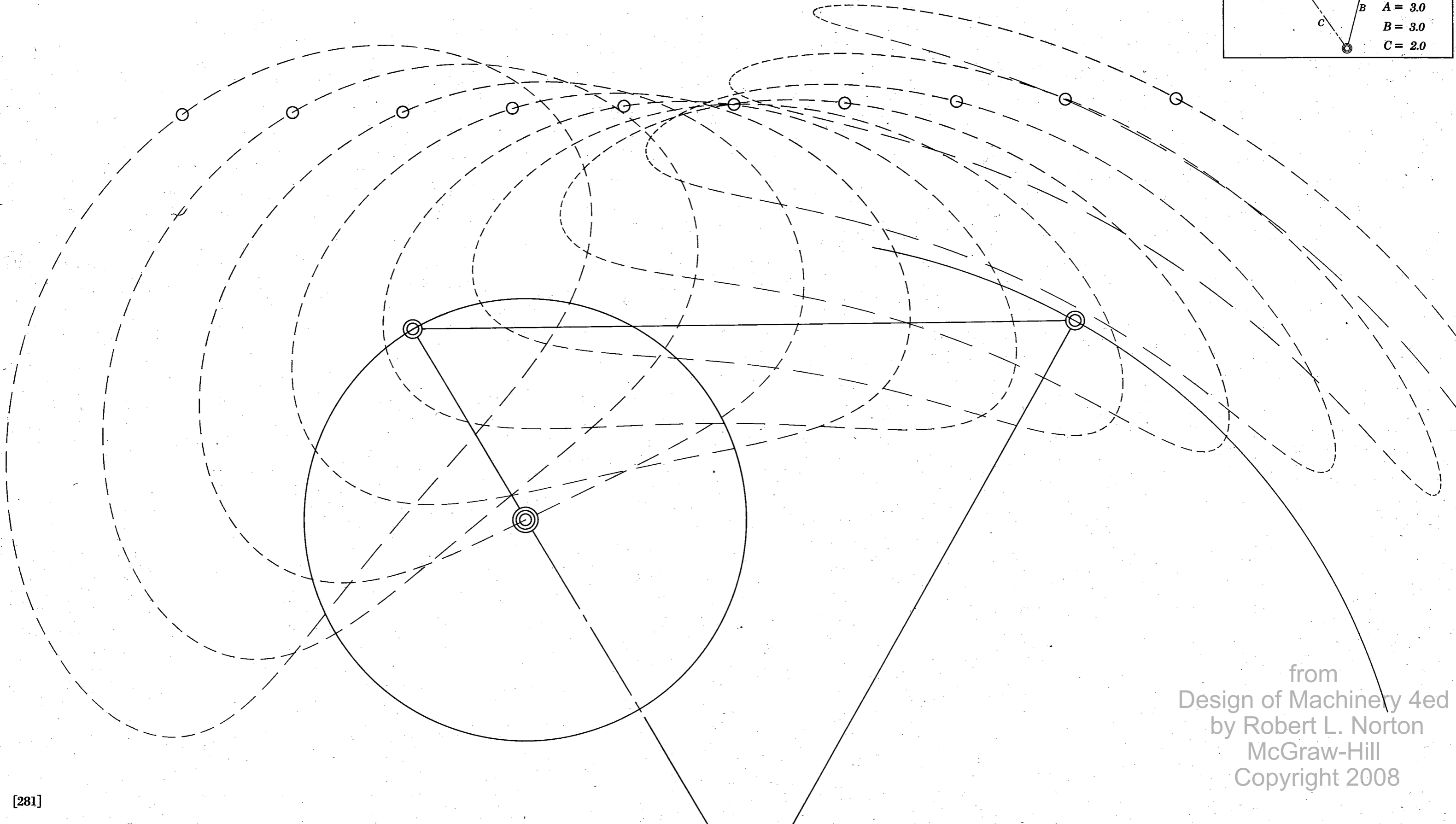
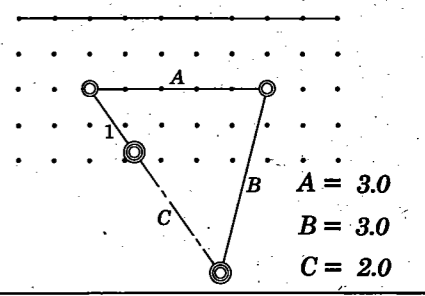

from  
Design of Machinery 4ed  
by Robert L. Norton  
McGraw-Hill  
Copyright 2008



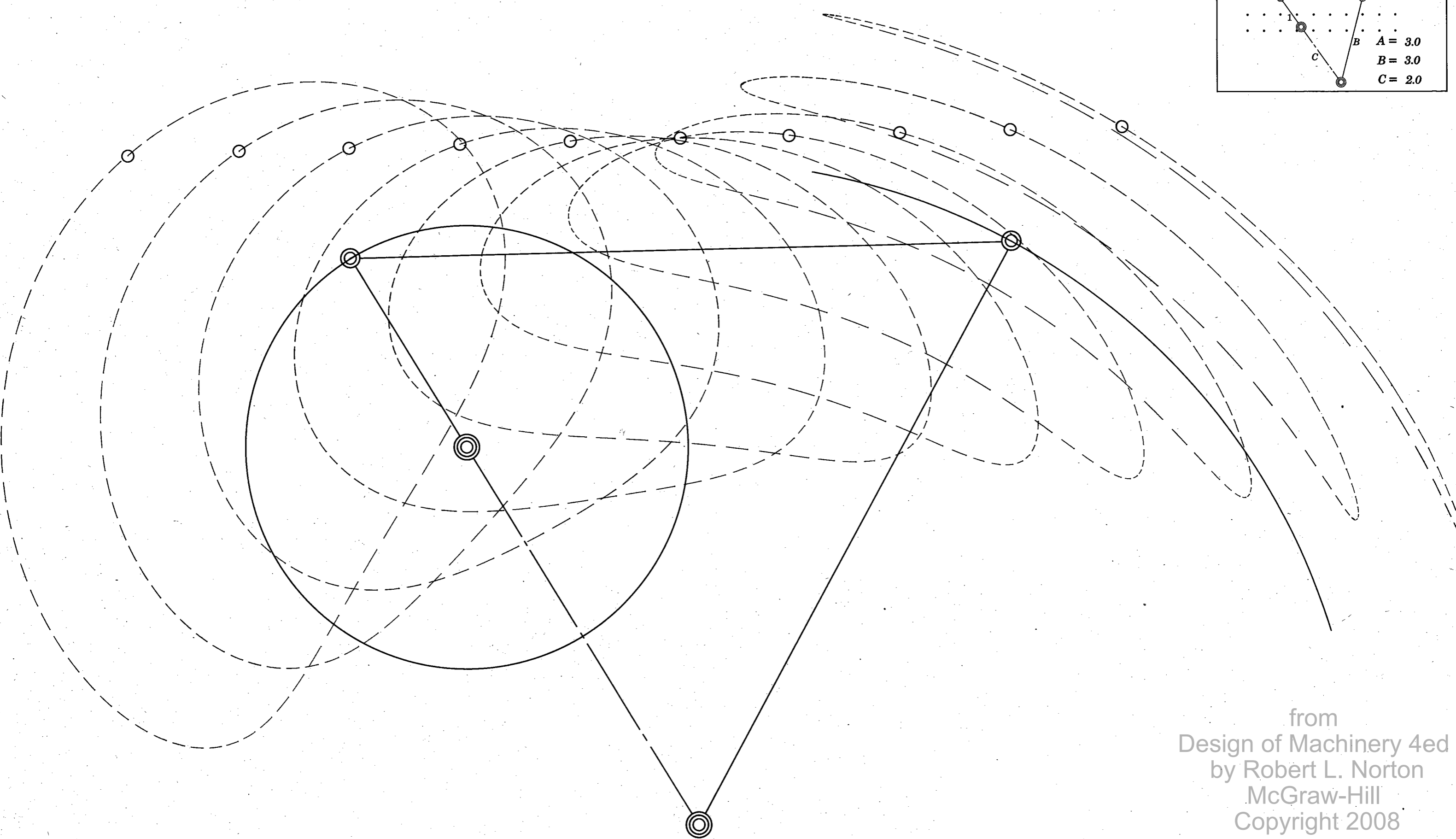
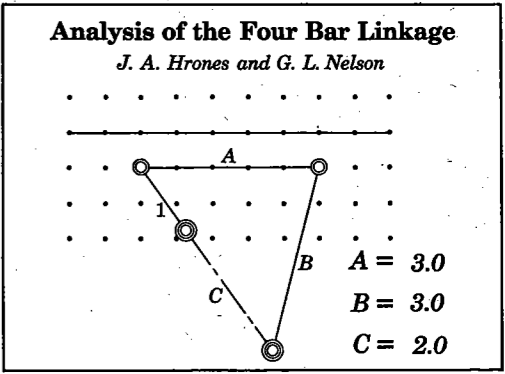

from  
Design of Machinery 4ed  
by Robert L. Norton  
McGraw-Hill  
Copyright 2008

**Analysis of the Four Bar Linkage**  
*J. A. Hrones and G. L. Nelson*

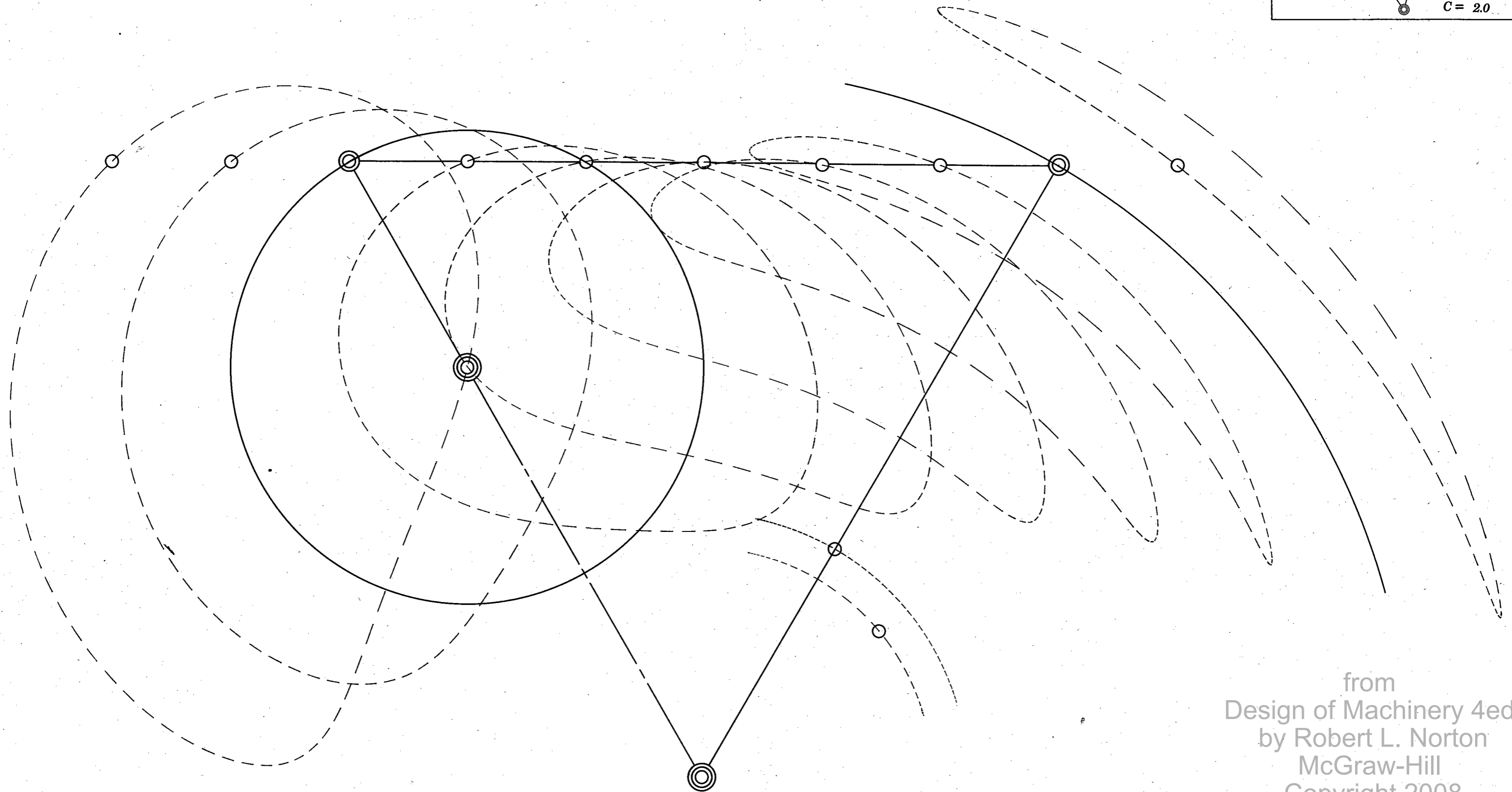
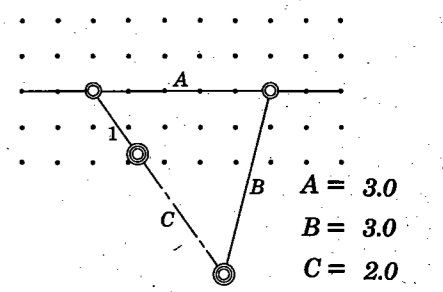

from  
Design of Machinery 4ed  
by Robert L. Norton  
McGraw-Hill  
Copyright 2008

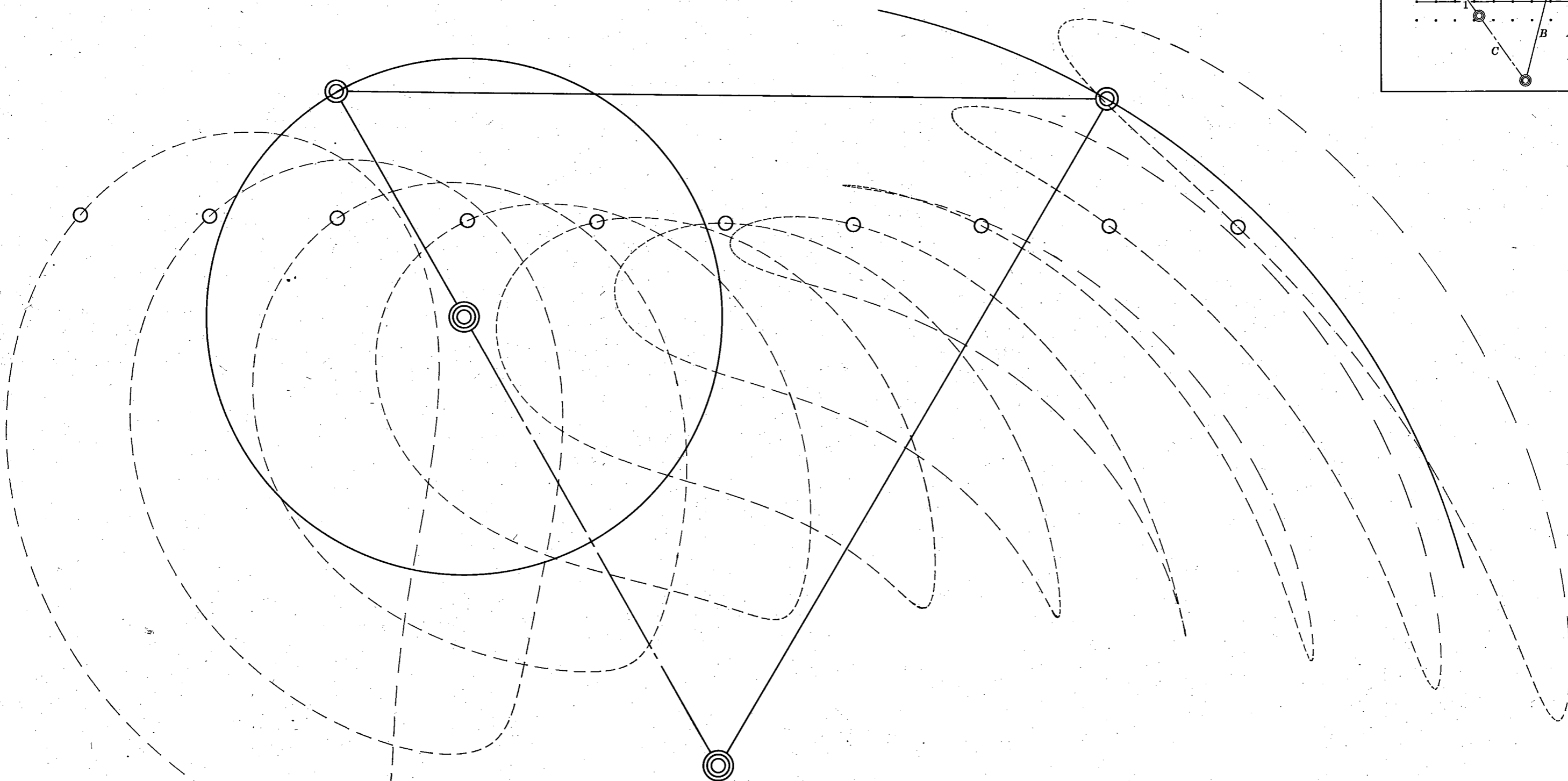
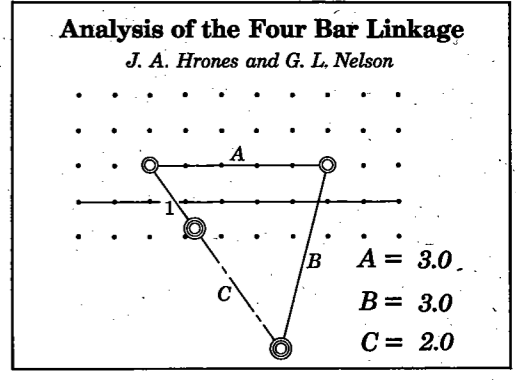

from  
Design of Machinery 4ed  
by Robert L. Norton  
McGraw-Hill  
Copyright 2008

**Analysis of the Four Bar Linkage**  
*J. A. Hrones and G. L. Nelson*

$A = 3.0$   
 $B = 3.0$   
 $C = 2.0$

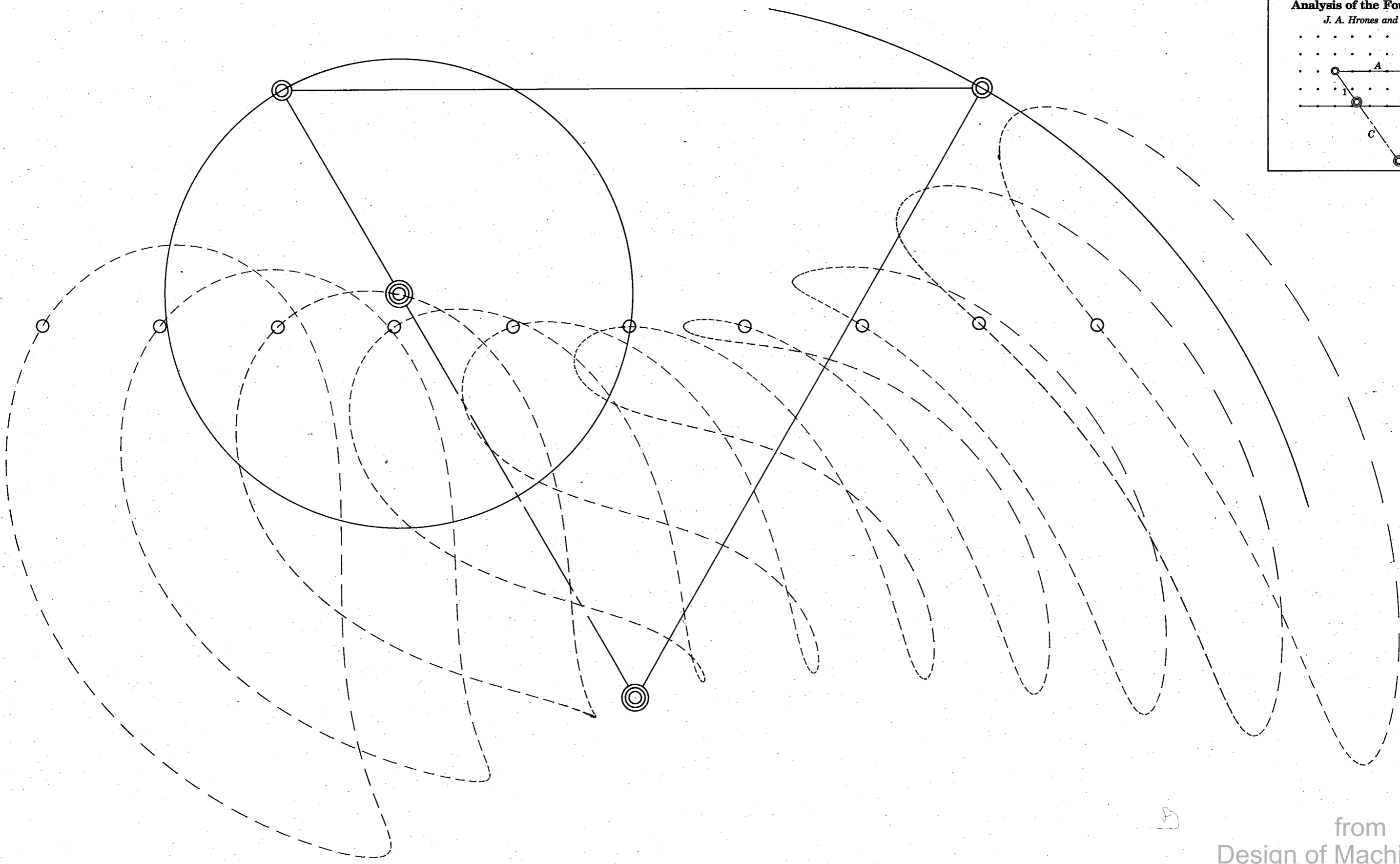

from  
 Design of Machinery 4ed  
 by Robert L. Norton  
 McGraw-Hill  
 Copyright 2008

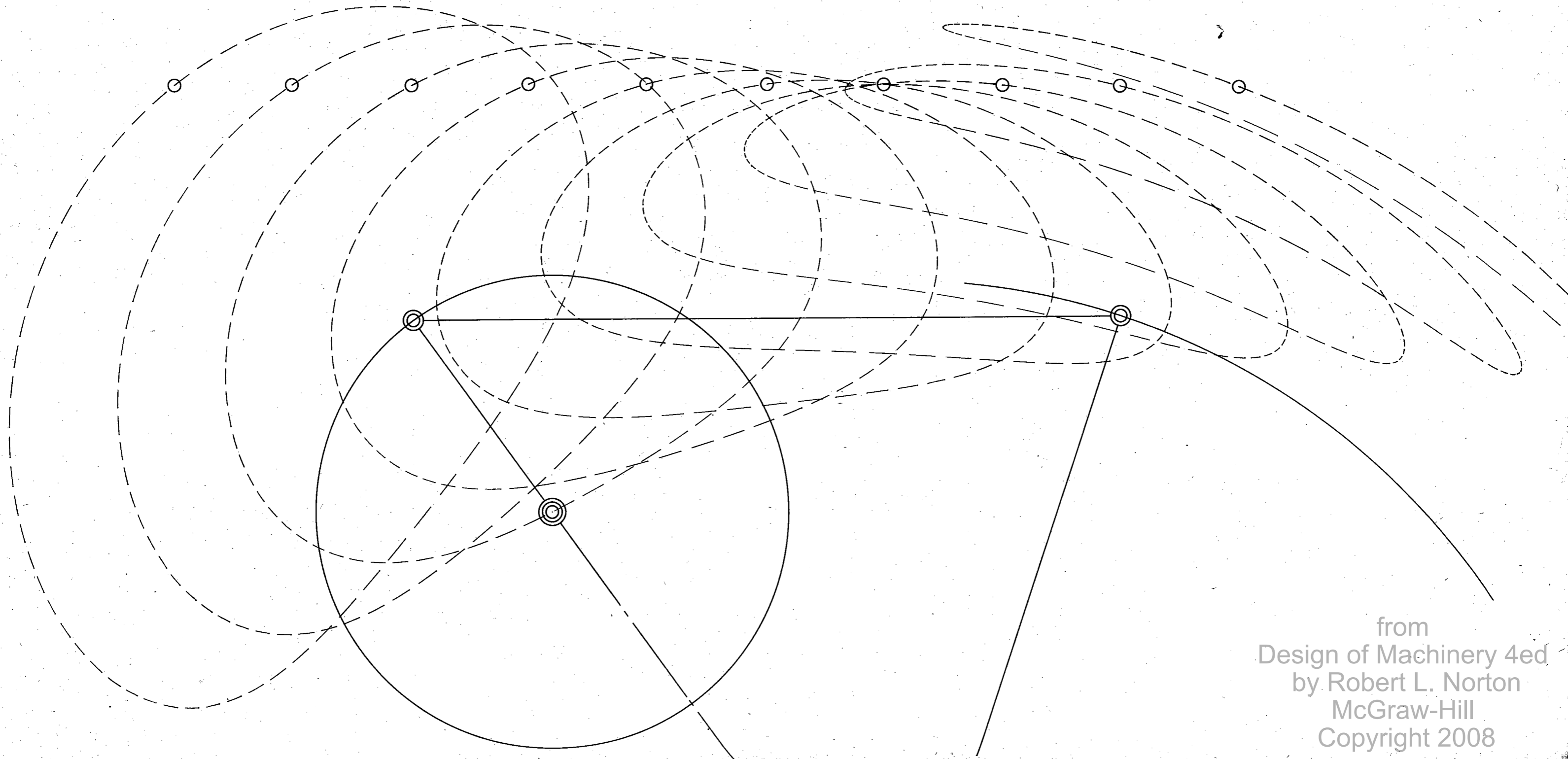
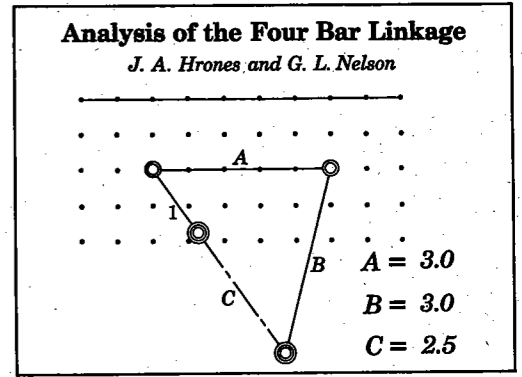

from  
Design of Machinery 4ed  
by Robert L. Norton  
McGraw-Hill  
Copyright 2008

**Analysis of the Four Bar Linkage**  
*J. A. Hrones and G. L. Nelson*

$A = 3.0$   
 $B = 3.0$   
 $C = 2.5$

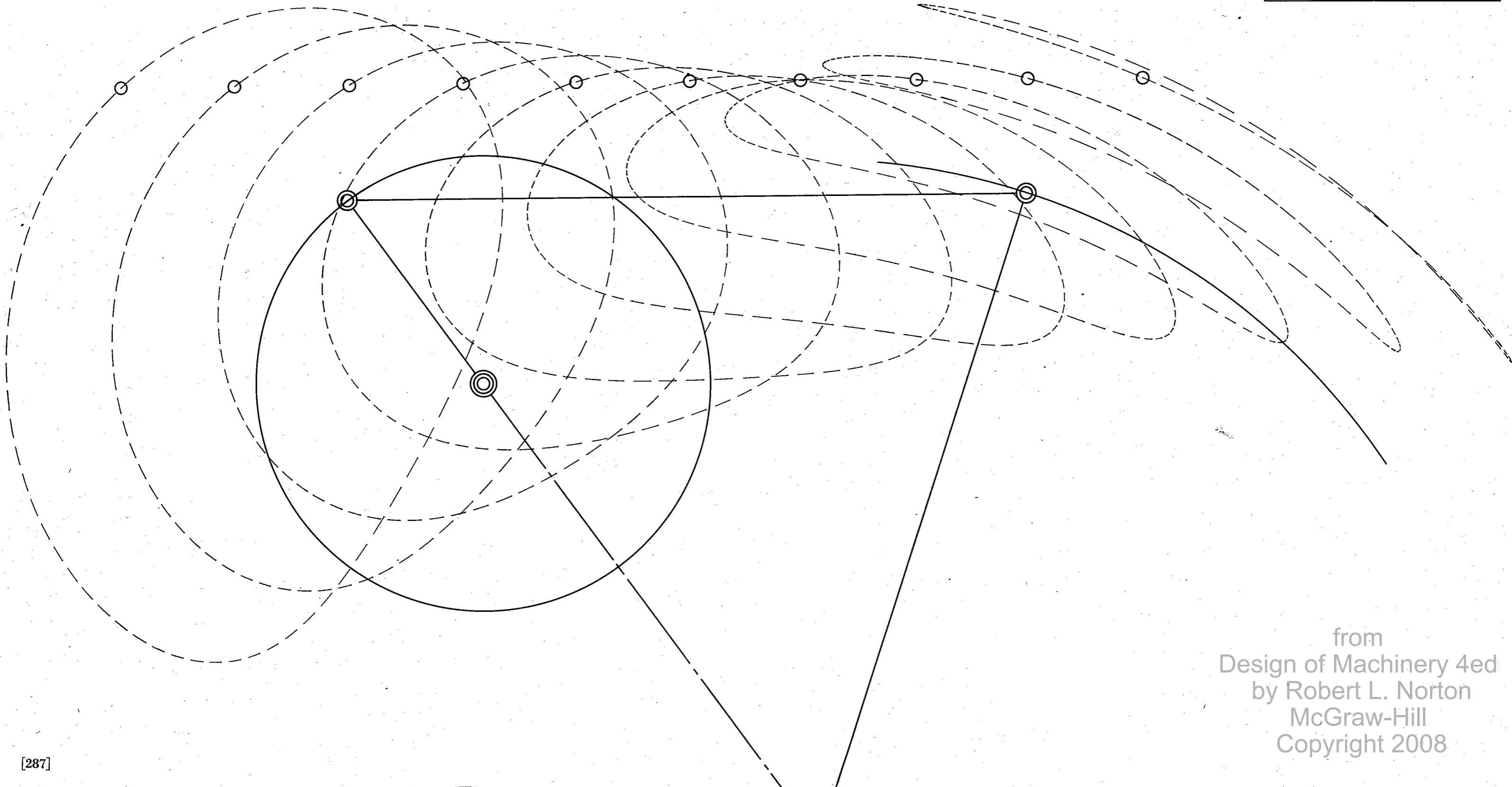

from  
 Design of Machinery 4ed  
 by Robert L. Norton  
 McGraw-Hill  
 Copyright 2008

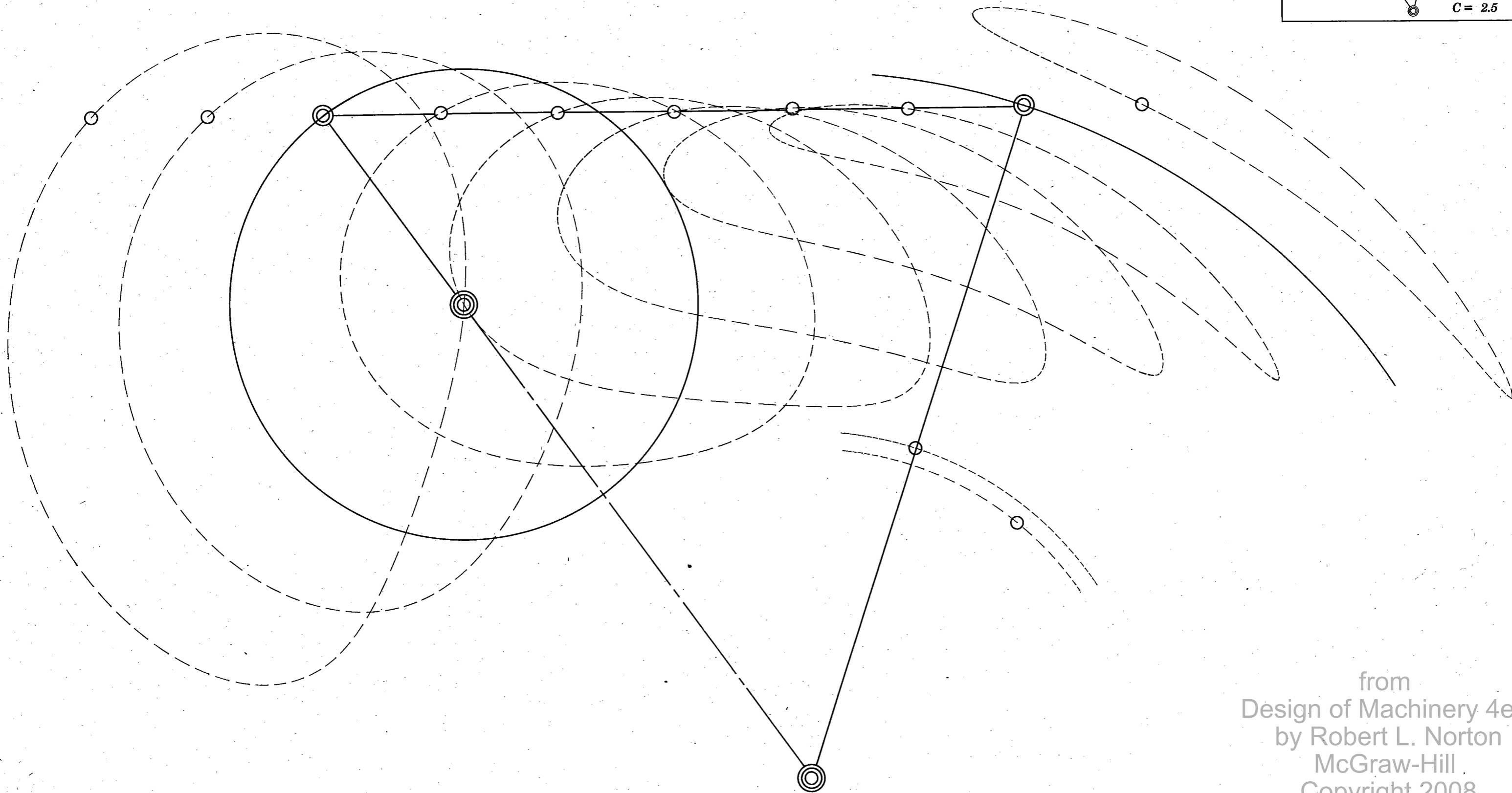
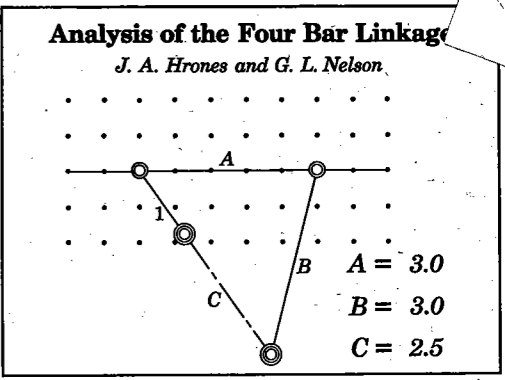

from  
Design of Machinery 4ed  
by Robert L. Norton  
McGraw-Hill  
Copyright 2008

**Analysis of the Four Bar Linkage**  
*J. A. Hrones and G. E. Nelson*

$A = 3.0$   
 $B = 3.0$   
 $C = 2.5$

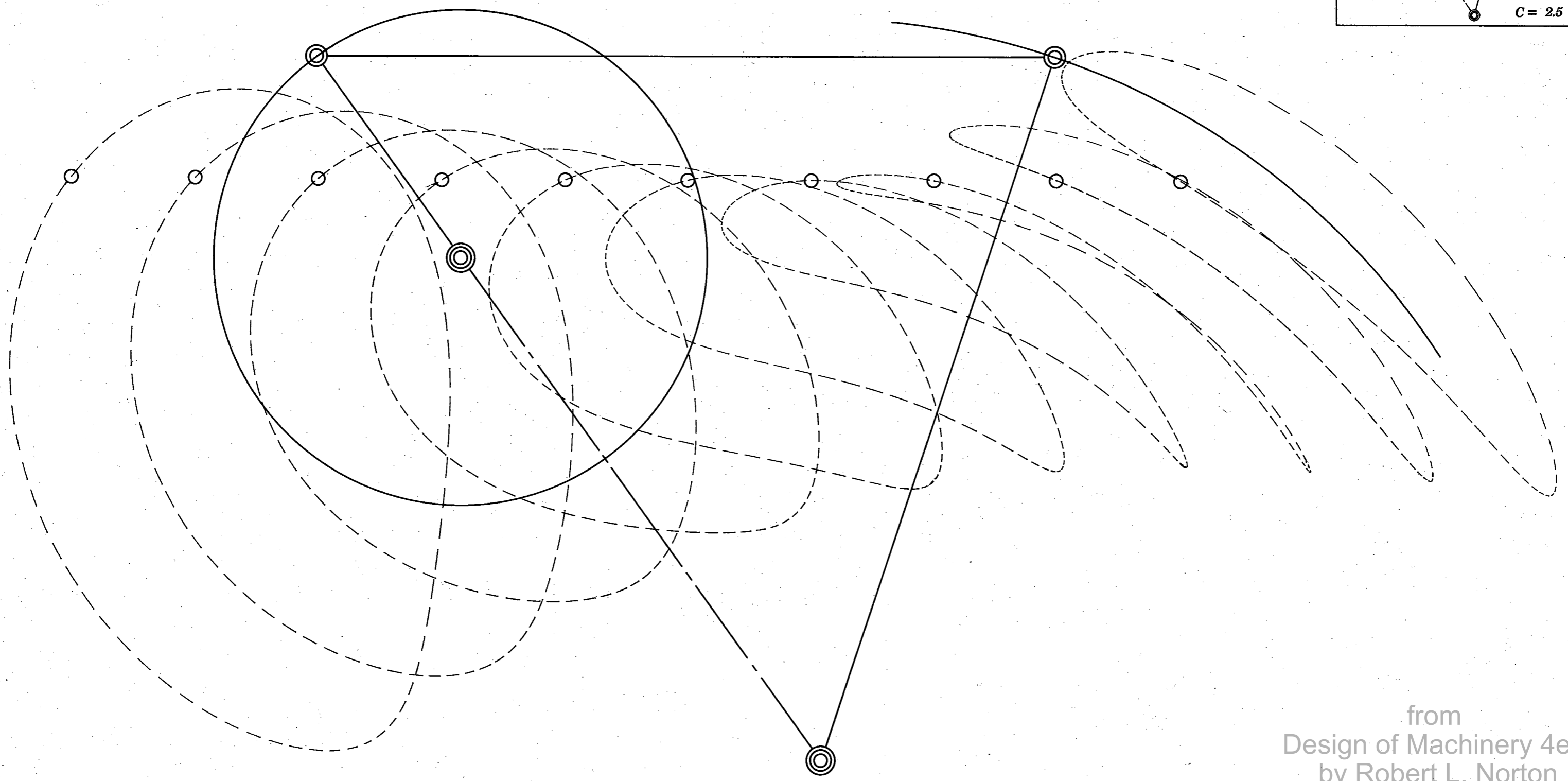

from  
 Design of Machinery 4ed  
 by Robert L. Norton  
 McGraw-Hill  
 Copyright 2008



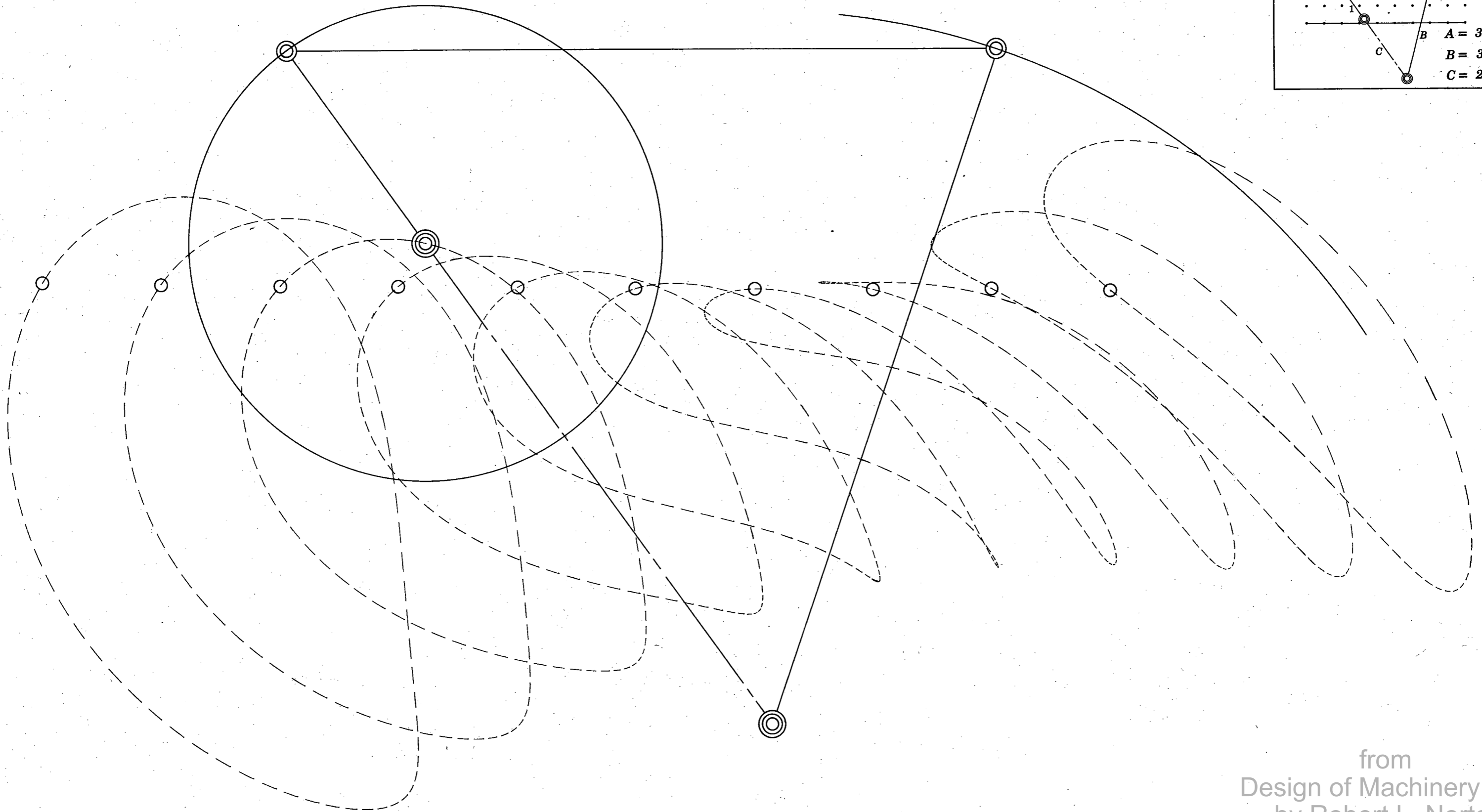
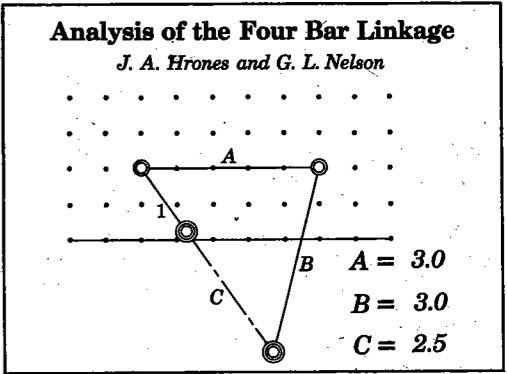

from  
Design of Machinery 4ed  
by Robert L. Norton  
McGraw-Hill  
Copyright 2008

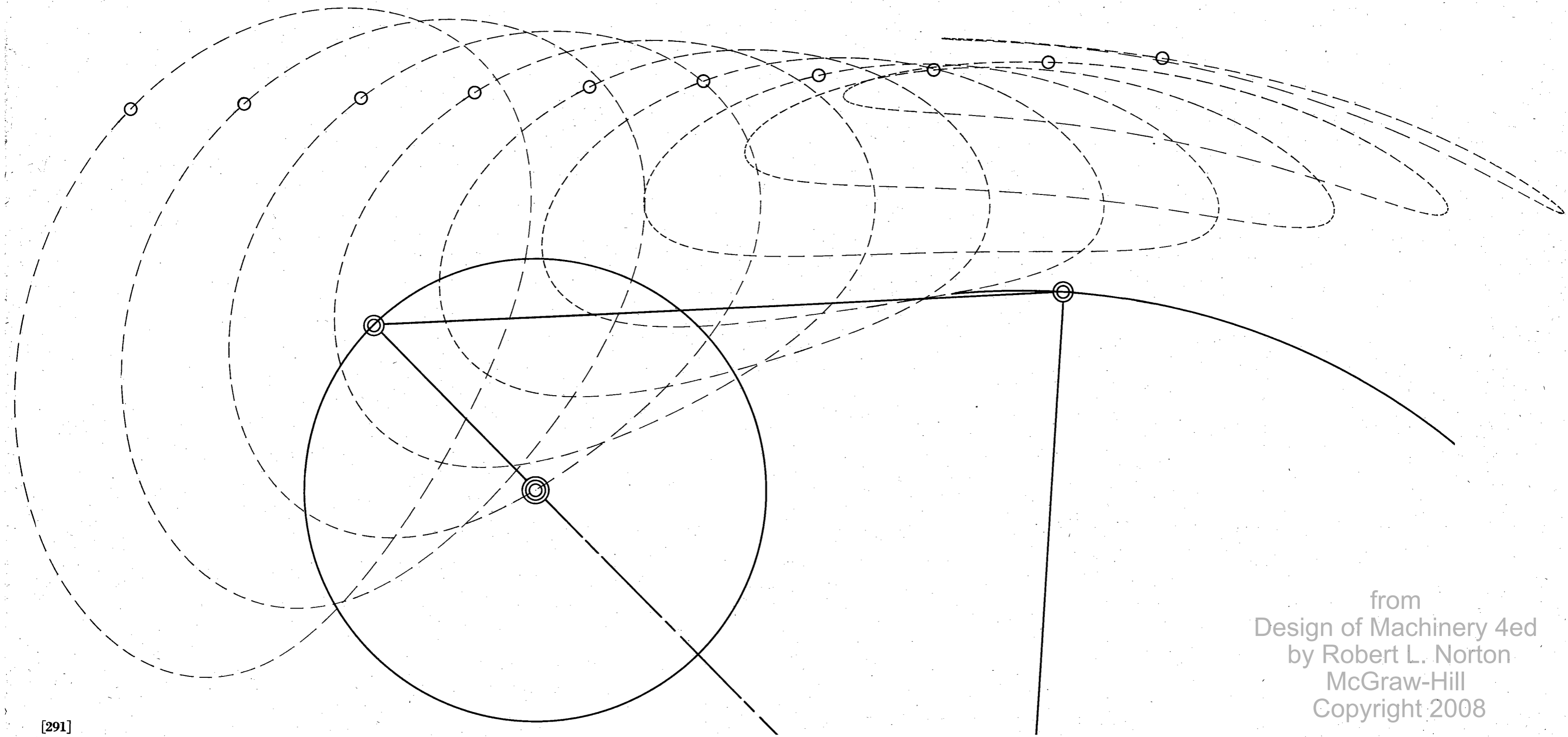
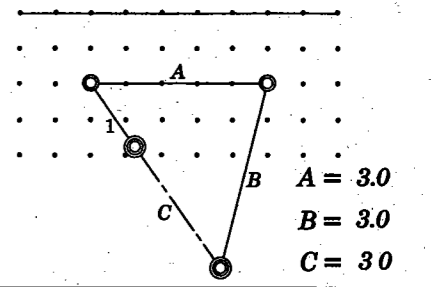

from  
Design of Machinery 4ed  
by Robert L. Norton  
McGraw-Hill  
Copyright 2008

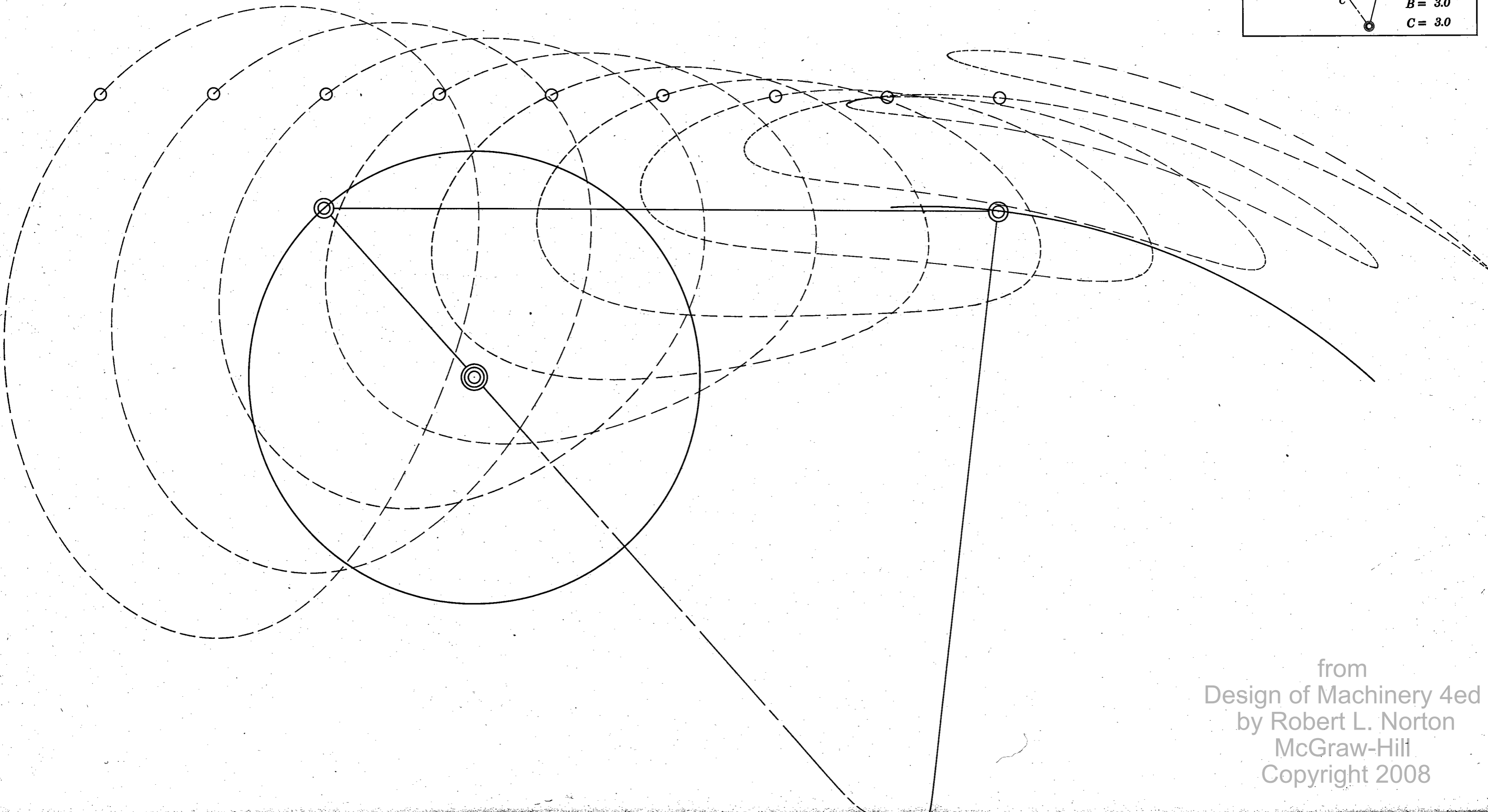
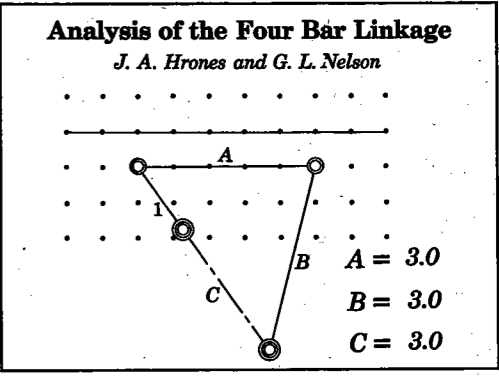

from  
Design of Machinery 4ed  
by Robert L. Norton  
McGraw-Hill  
Copyright 2008

**Analysis of the Four Bar Linkage**

*J. A. Hrones and G. L. Nelson*

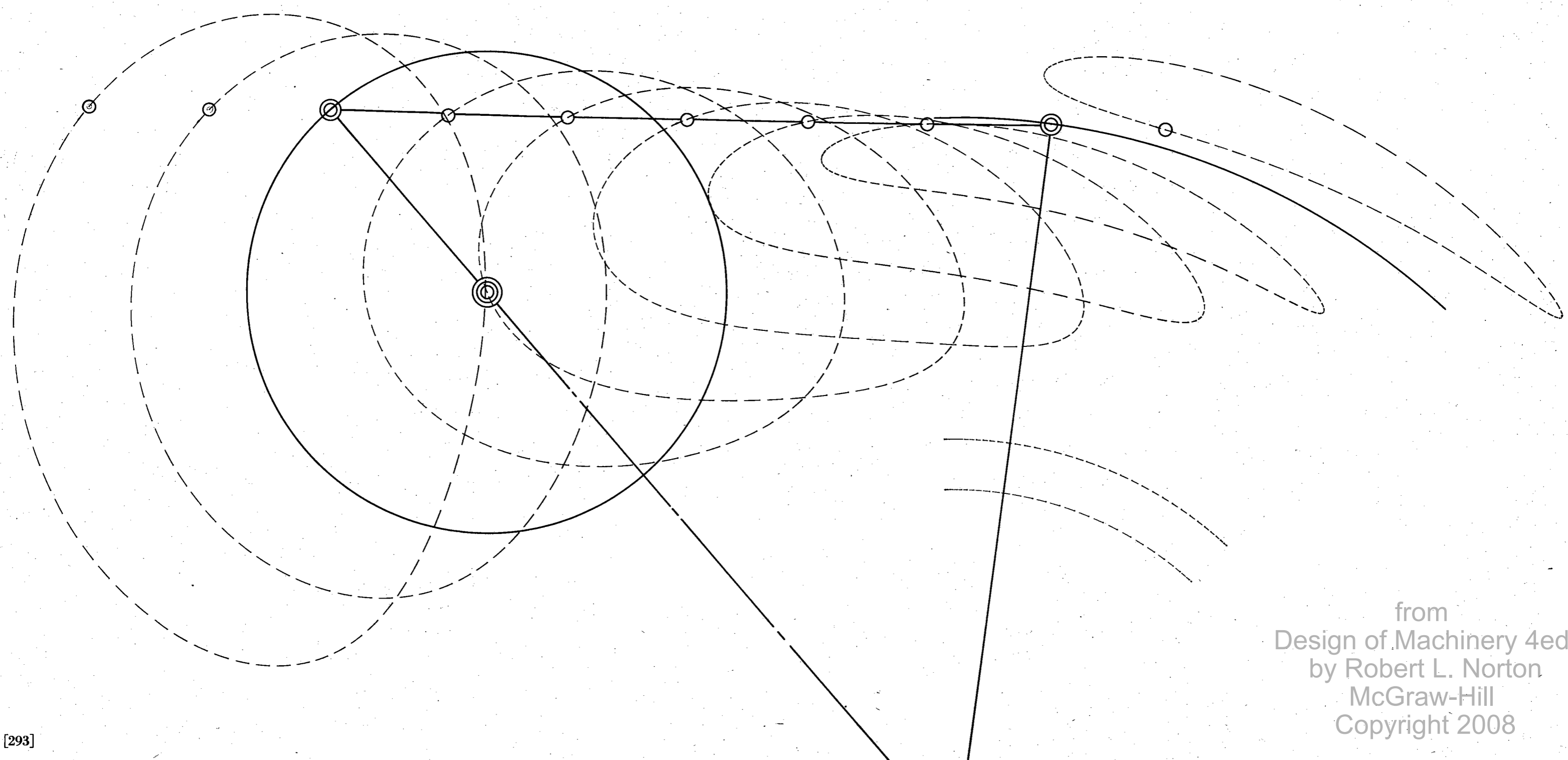
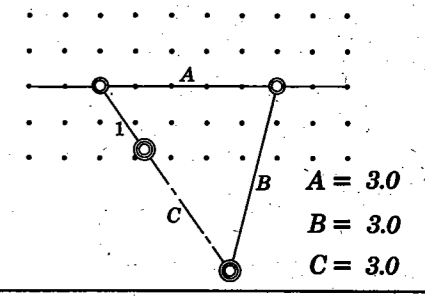

from  
Design of Machinery 4ed  
by Robert L. Norton  
McGraw-Hill  
Copyright 2008

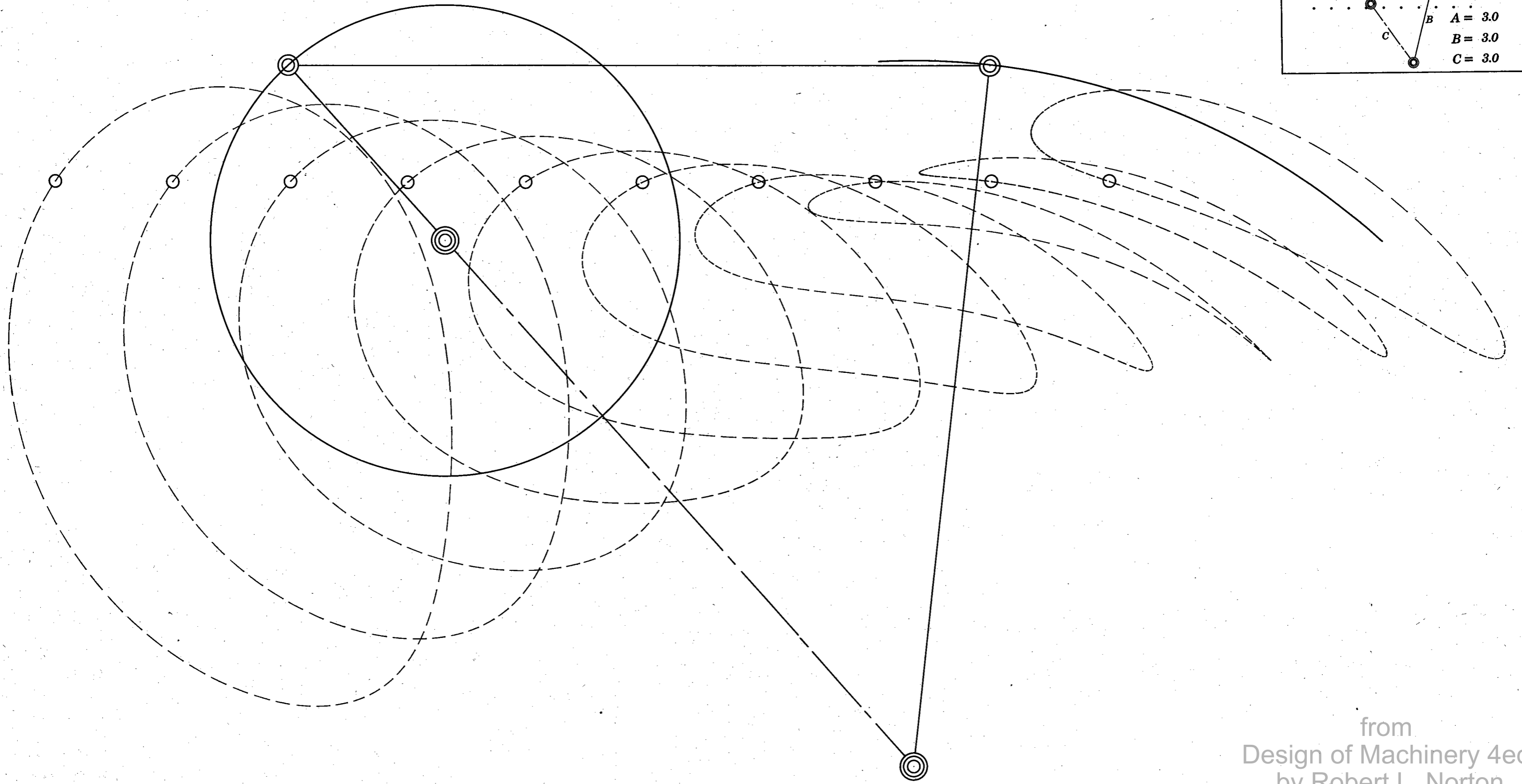
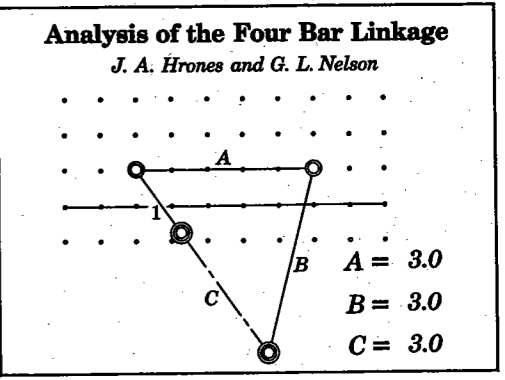

from  
Design of Machinery 4ed  
by Robert L. Norton  
McGraw-Hill  
Copyright 2008

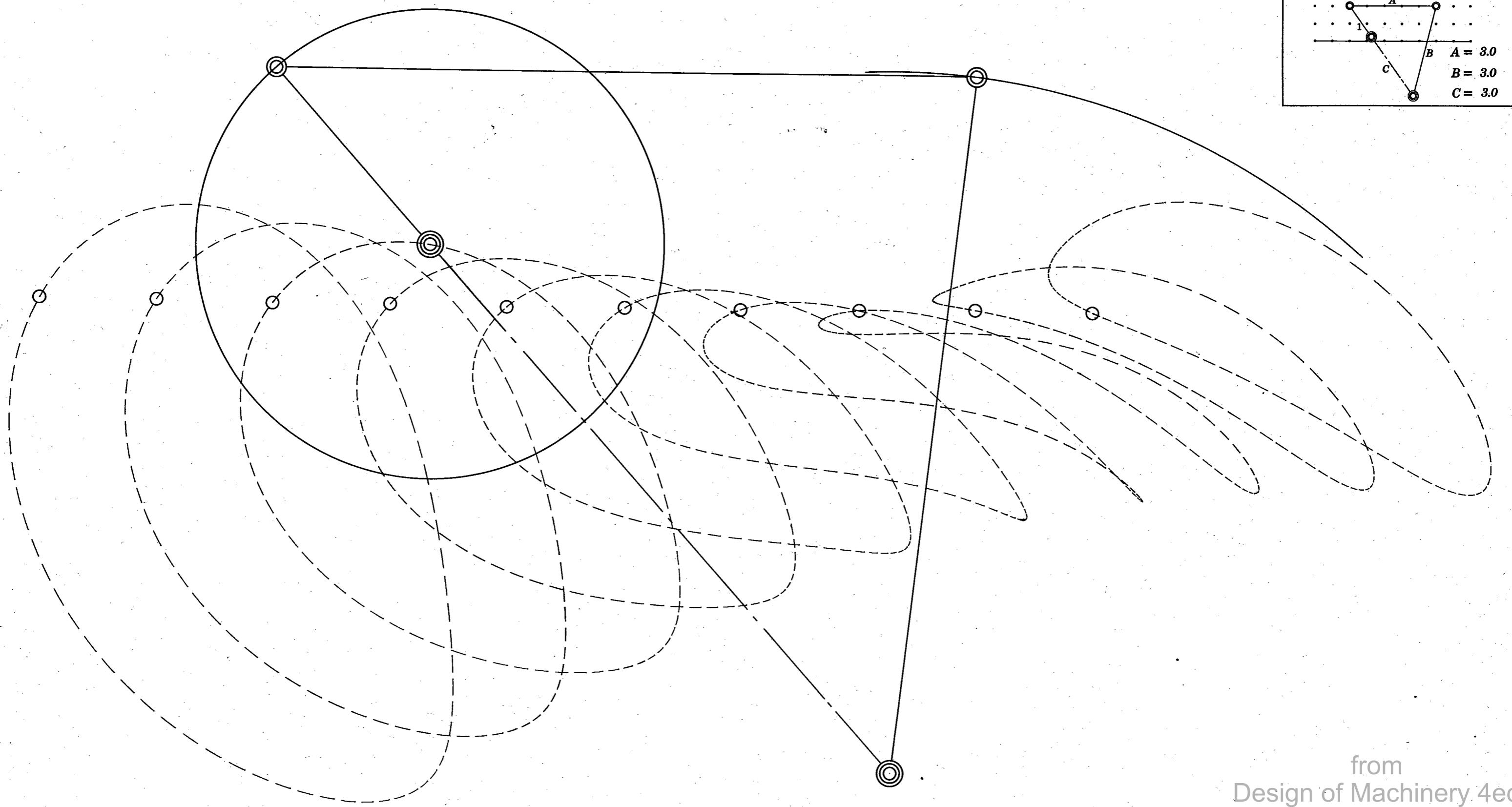
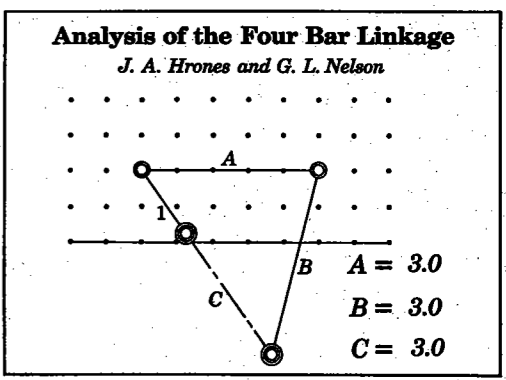

from  
 Design of Machinery, 4ed  
 by Robert L. Norton  
 McGraw-Hill  
 Copyright 2008

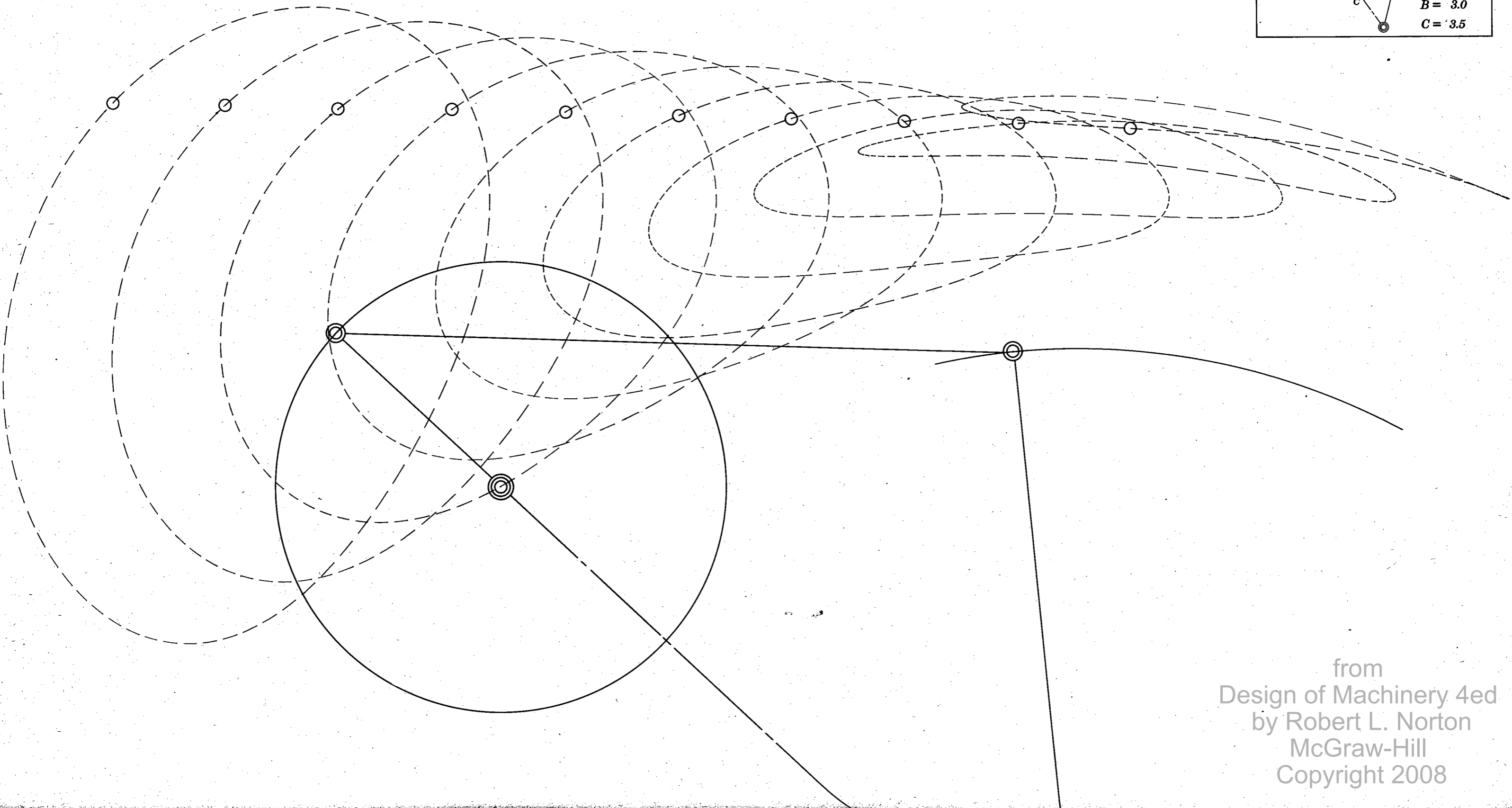
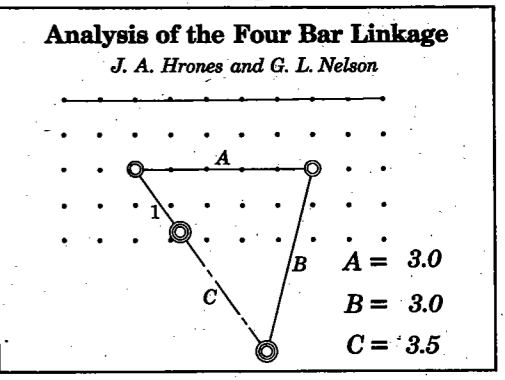

from  
Design of Machinery 4ed  
by Robert L. Norton  
McGraw-Hill  
Copyright 2008

**Analysis of the Four Bar Linkage**  
*J. A. Hrones and G. L. Nelson*

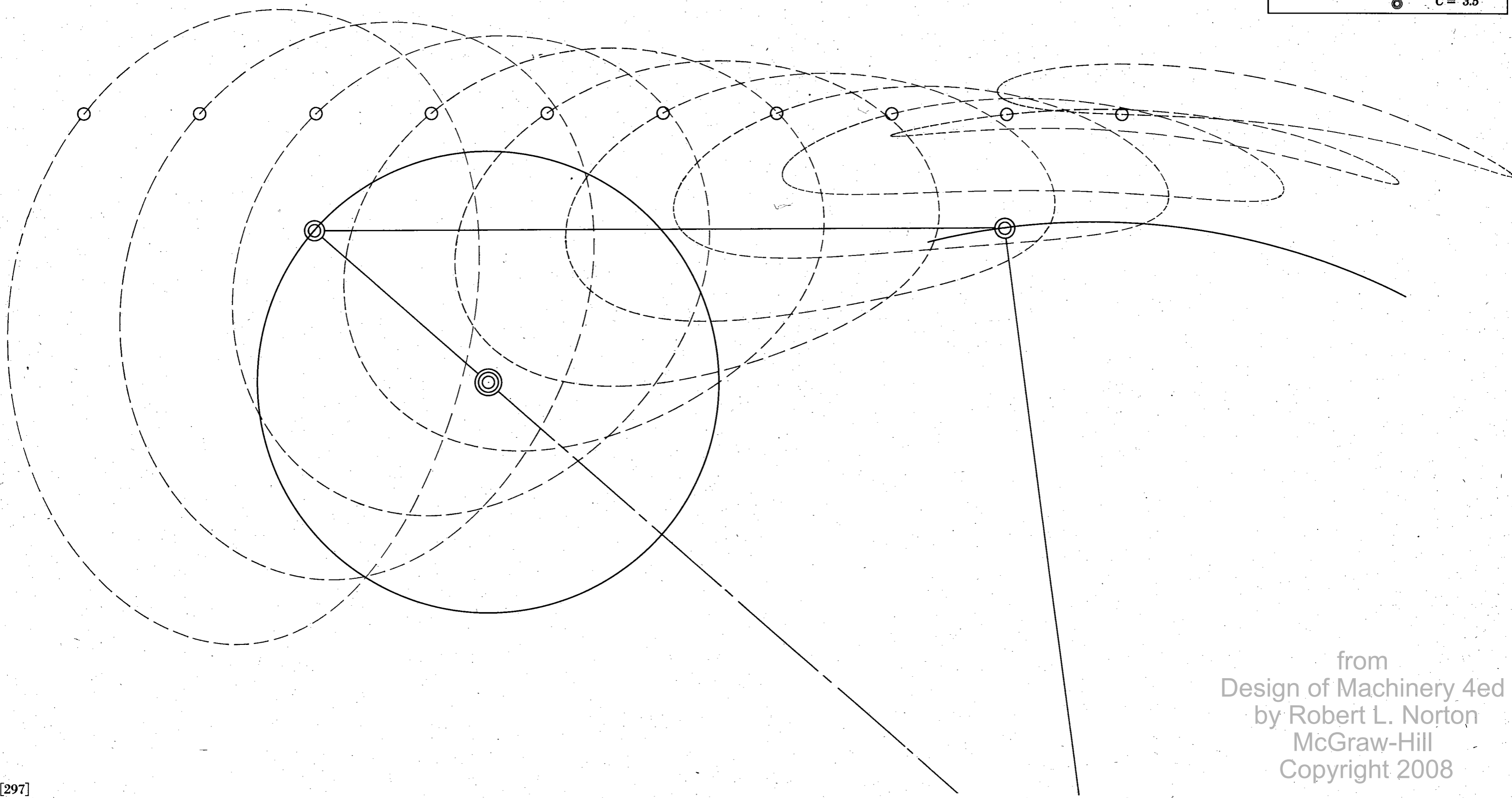
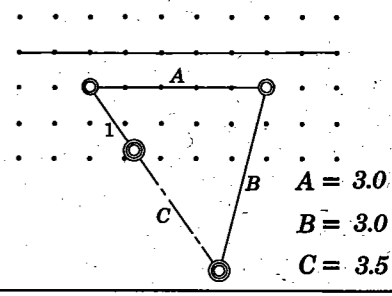

from  
Design of Machinery 4ed  
by Robert L. Norton  
McGraw-Hill  
Copyright 2008



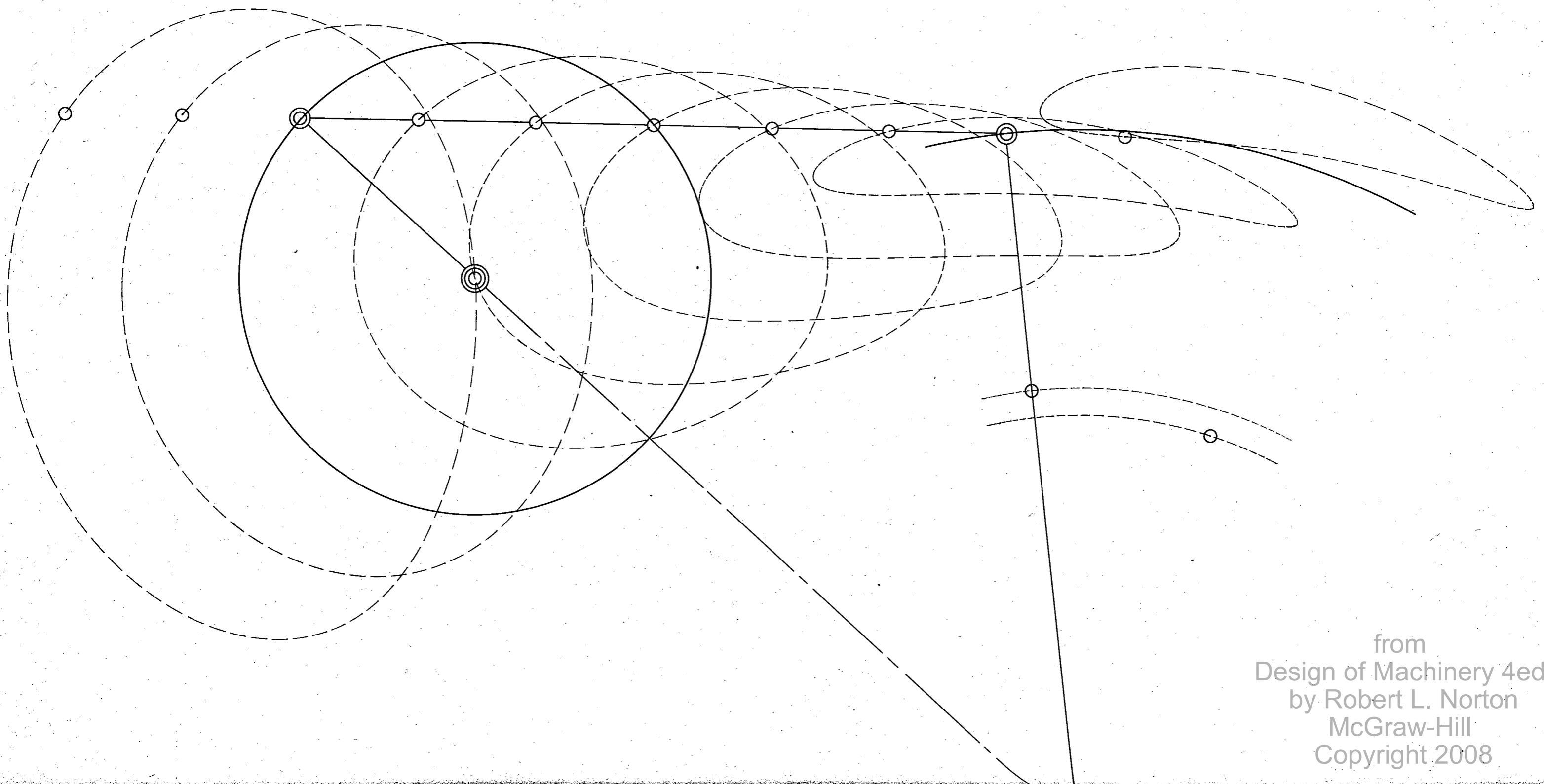
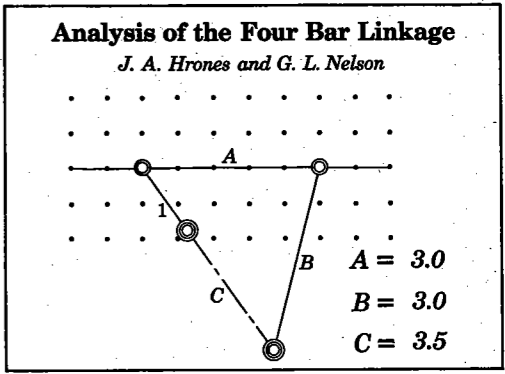

from  
Design of Machinery 4ed  
by Robert L. Norton  
McGraw-Hill  
Copyright 2008

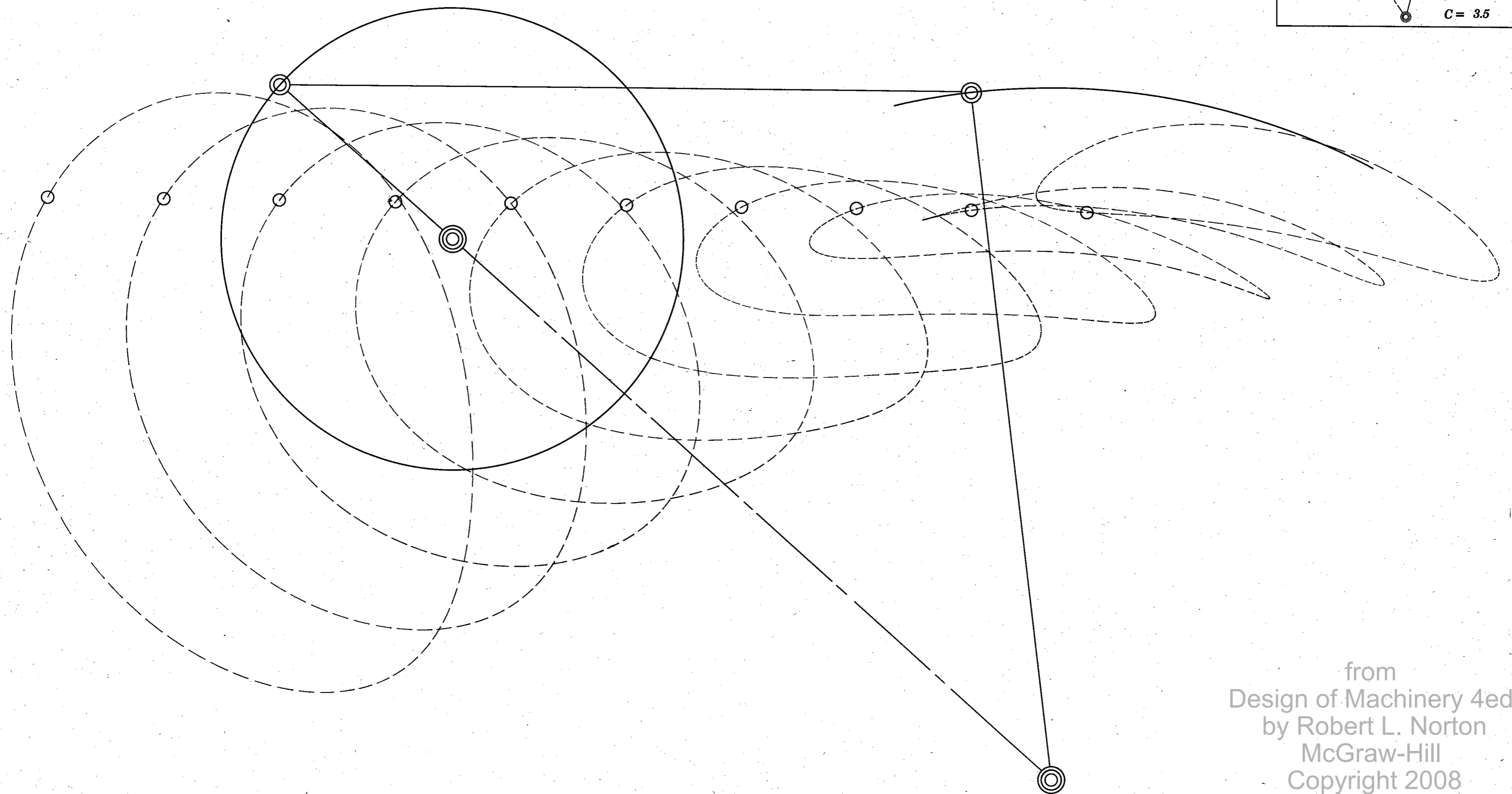
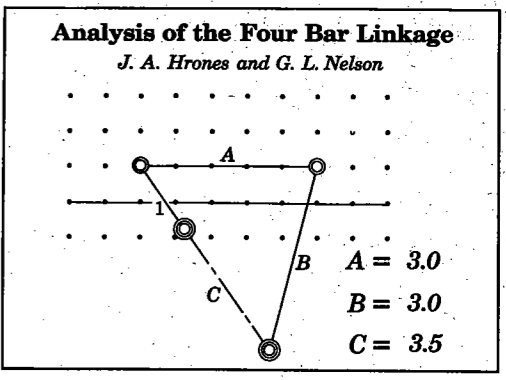

from  
 Design of Machinery 4ed  
 by Robert L. Norton  
 McGraw-Hill  
 Copyright 2008

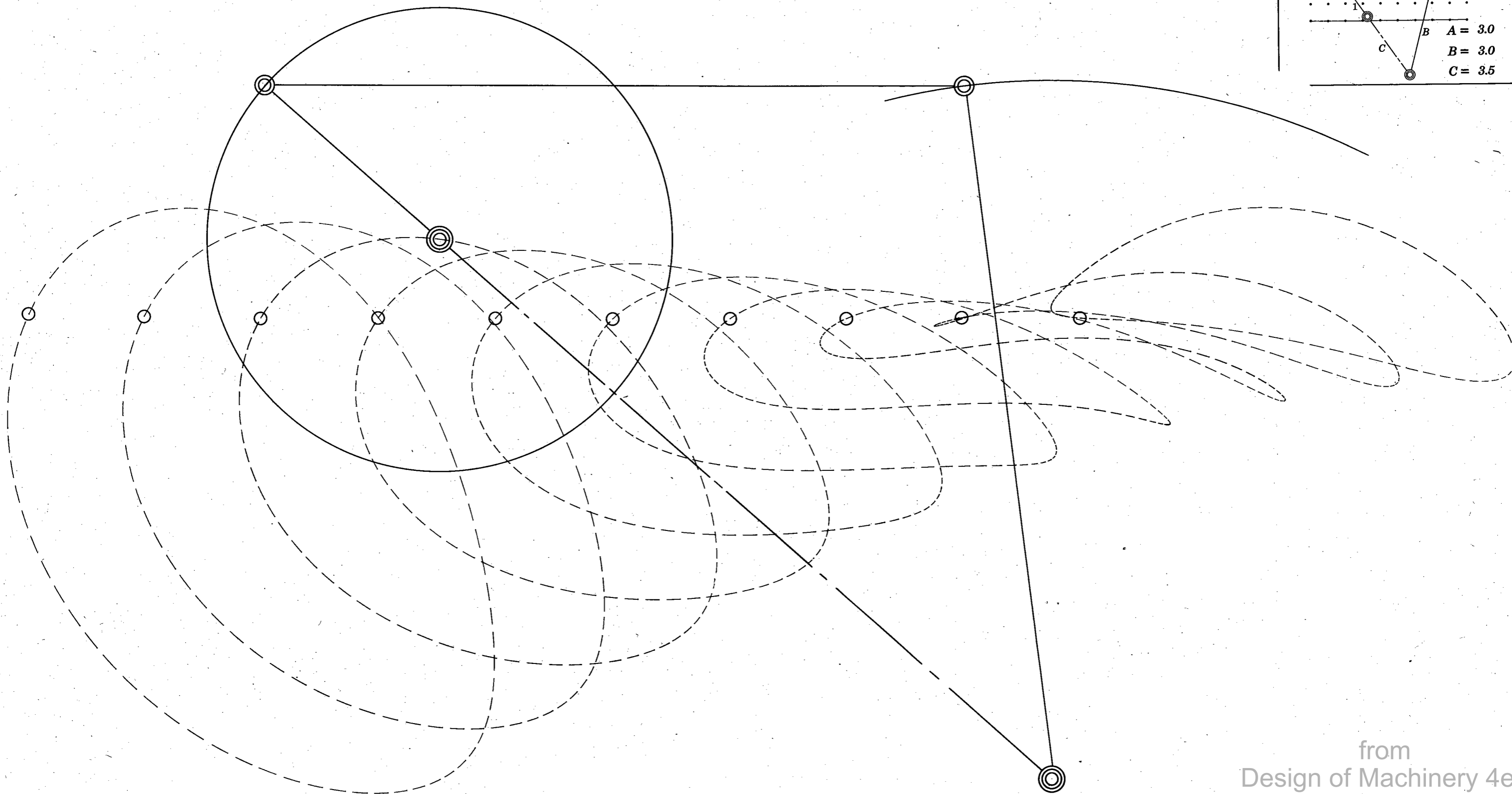
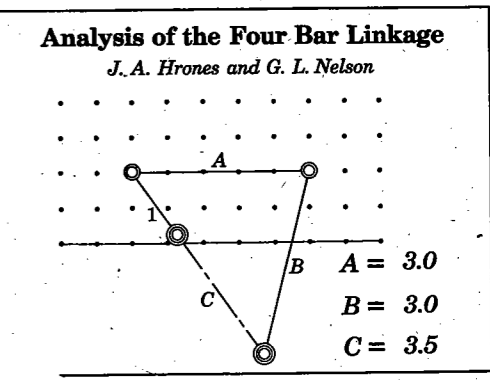

from  
Design of Machinery 4ed  
by Robert L. Norton  
McGraw-Hill  
Copyright 2008

**Analysis of the Four Bar Linkage**  
*J. A. Hrones and G. L. Nelson*

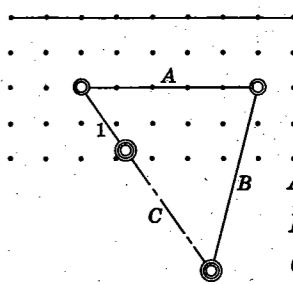

$A = 3.0$   
 $B = 3.0$   
 $C = 4.0$

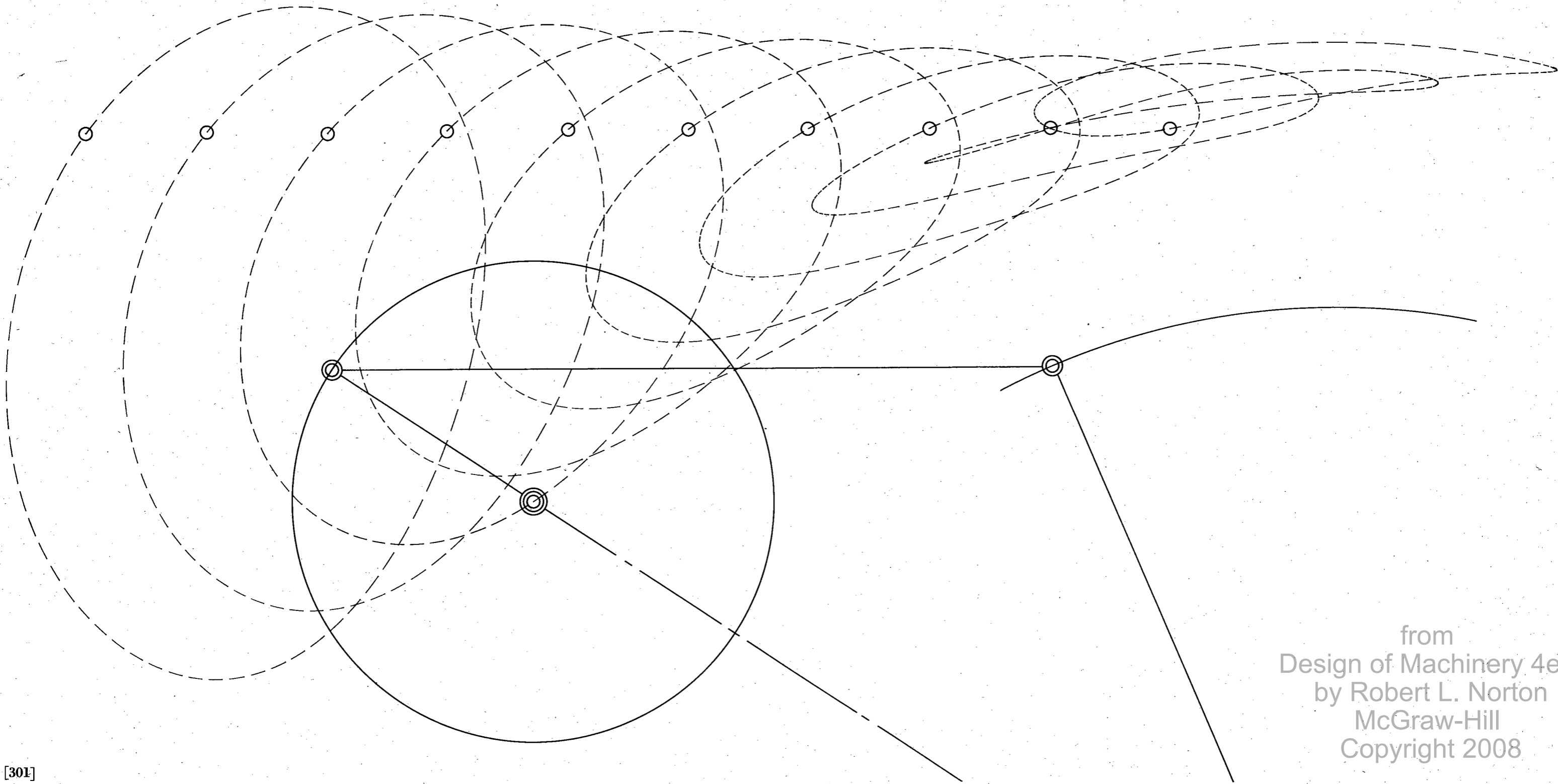

from  
 Design of Machinery 4ed  
 by Robert L. Norton  
 McGraw-Hill  
 Copyright 2008

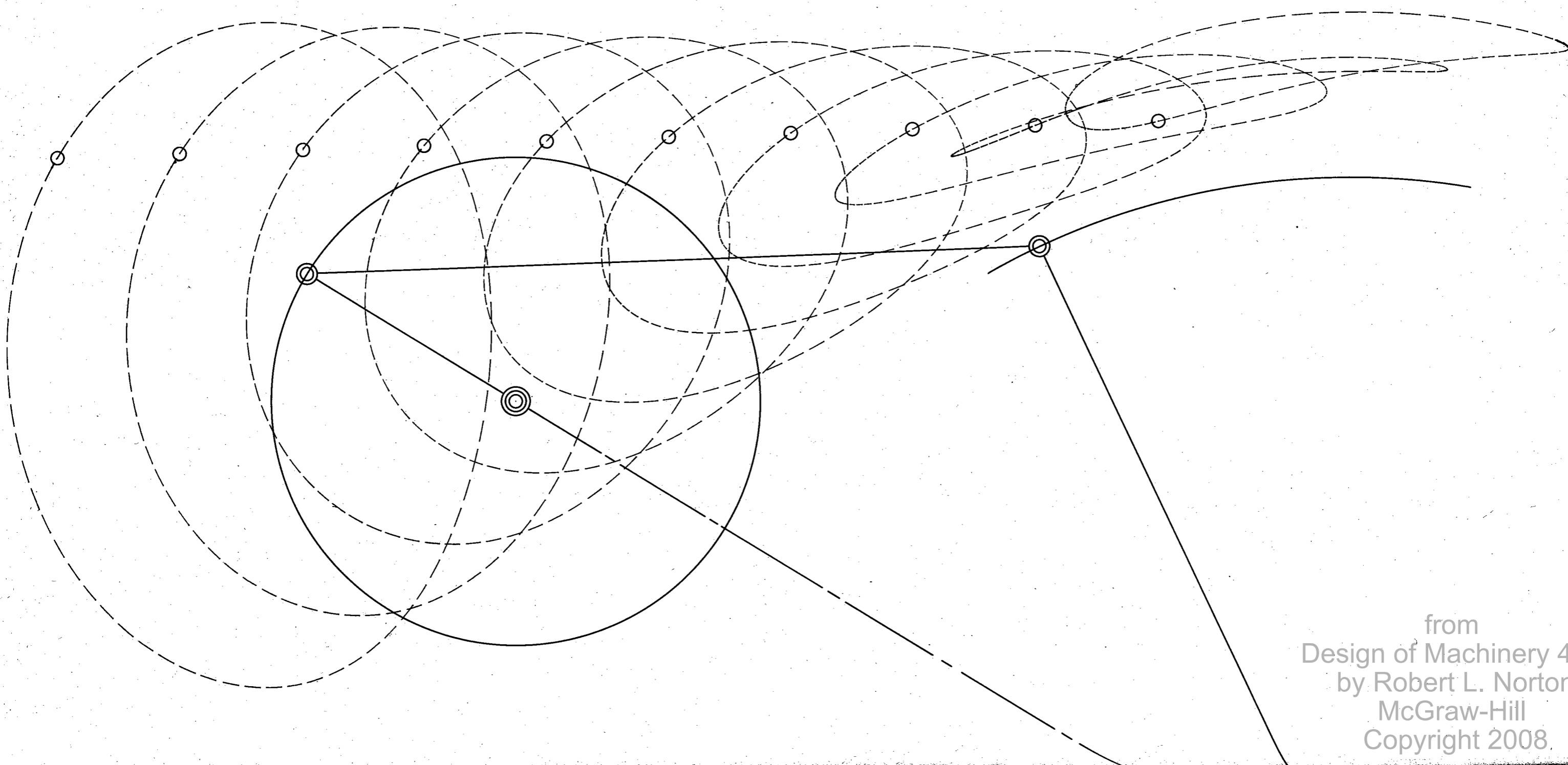
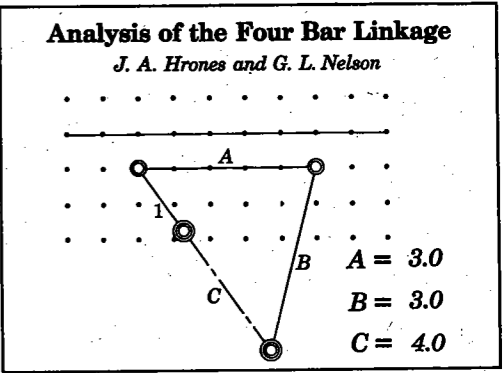

from  
Design of Machinery 4ed  
by Robert L. Norton  
McGraw-Hill  
Copyright 2008.

**Analysis of the Four Bar Linkage**

*J. A. Hrones and G. L. Nelson*

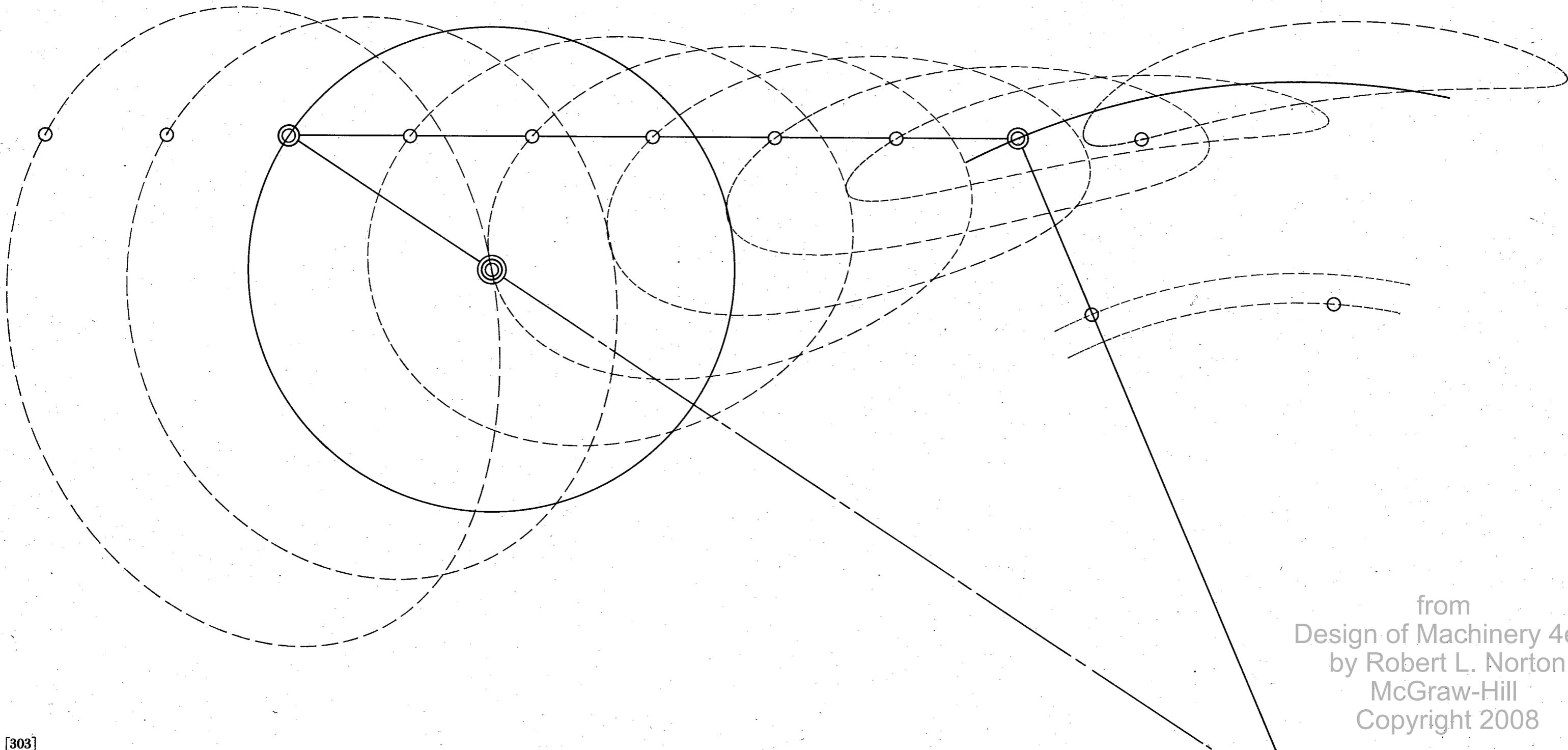
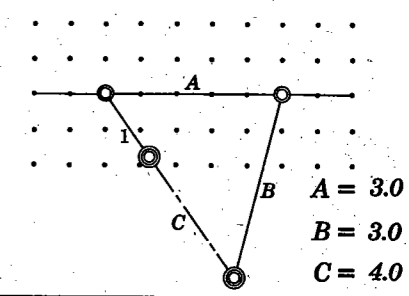

from  
Design of Machinery 4ed  
by Robert L. Norton  
McGraw-Hill  
Copyright 2008

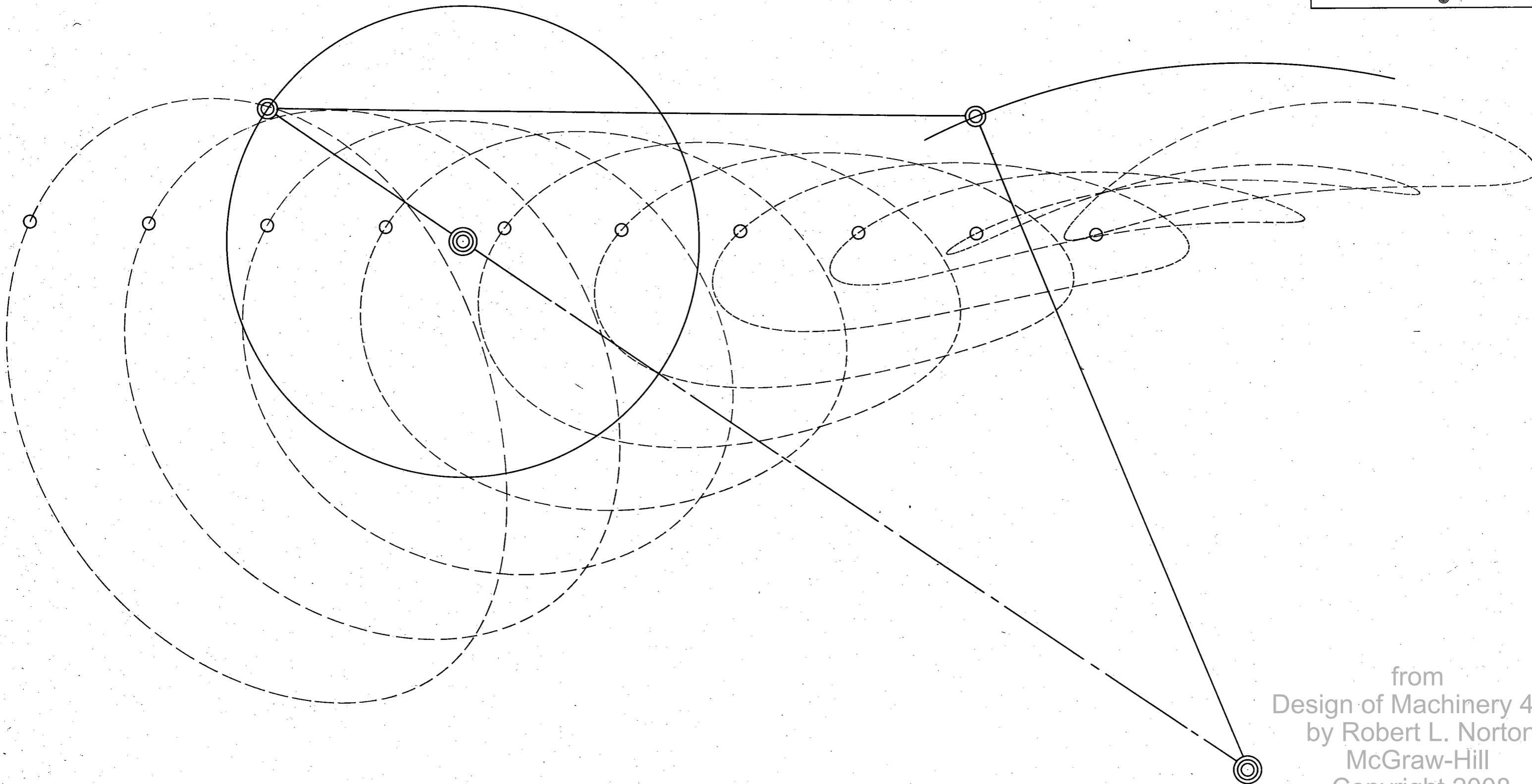
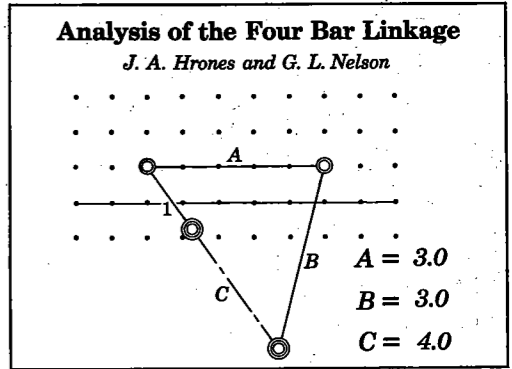

from  
Design of Machinery 4ed  
by Robert L. Norton  
McGraw-Hill  
Copyright 2008

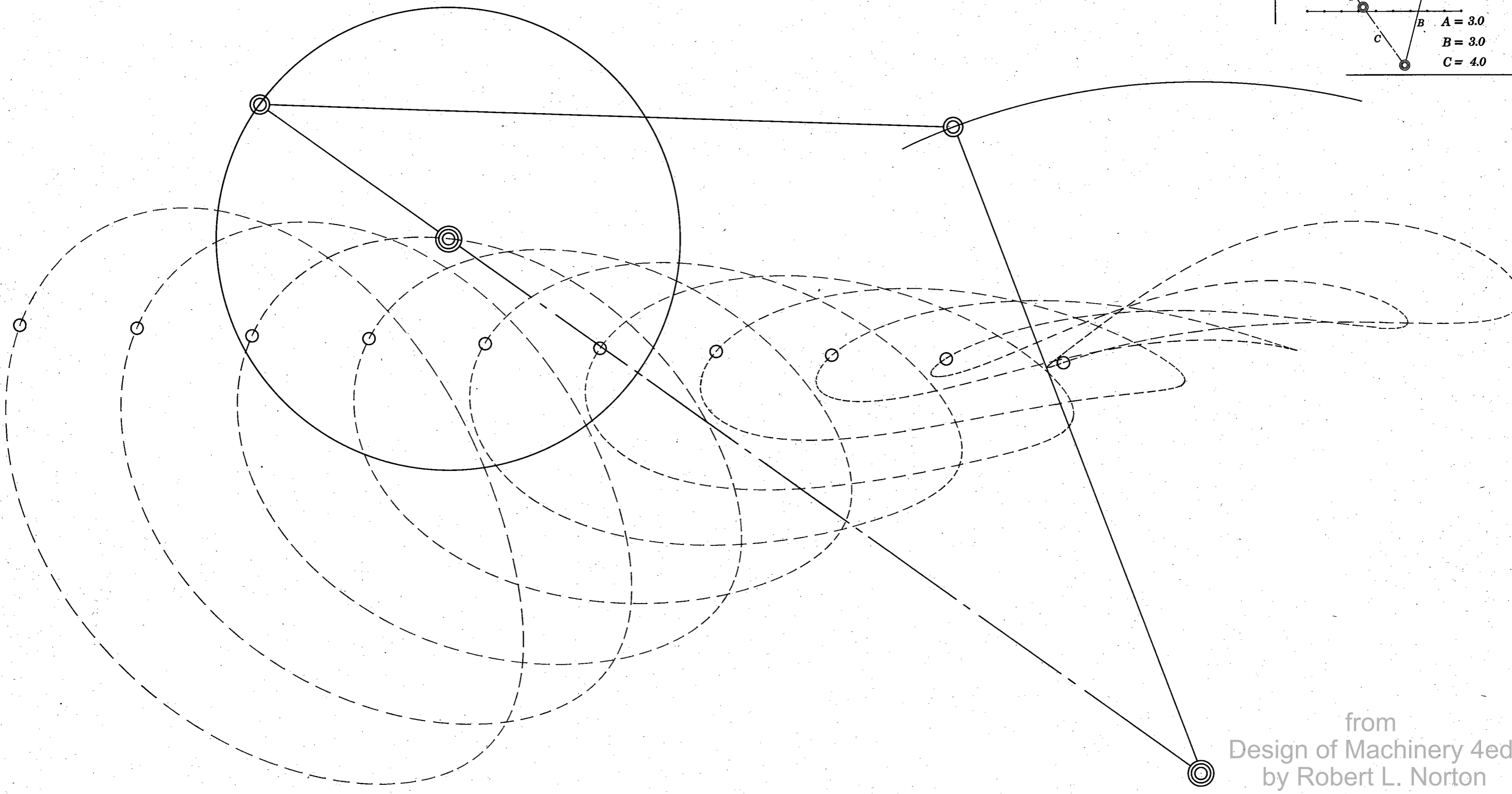
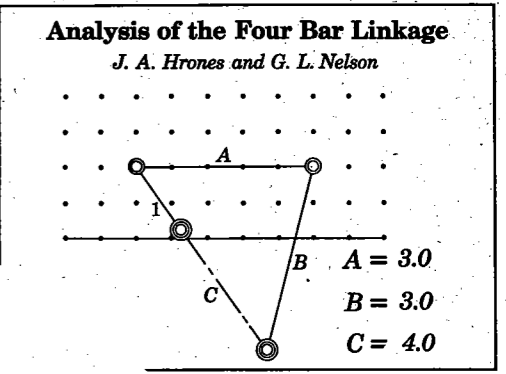

from  
 Design of Machinery 4ed  
 by Robert L. Norton  
 McGraw-Hill  
 Copyright 2008



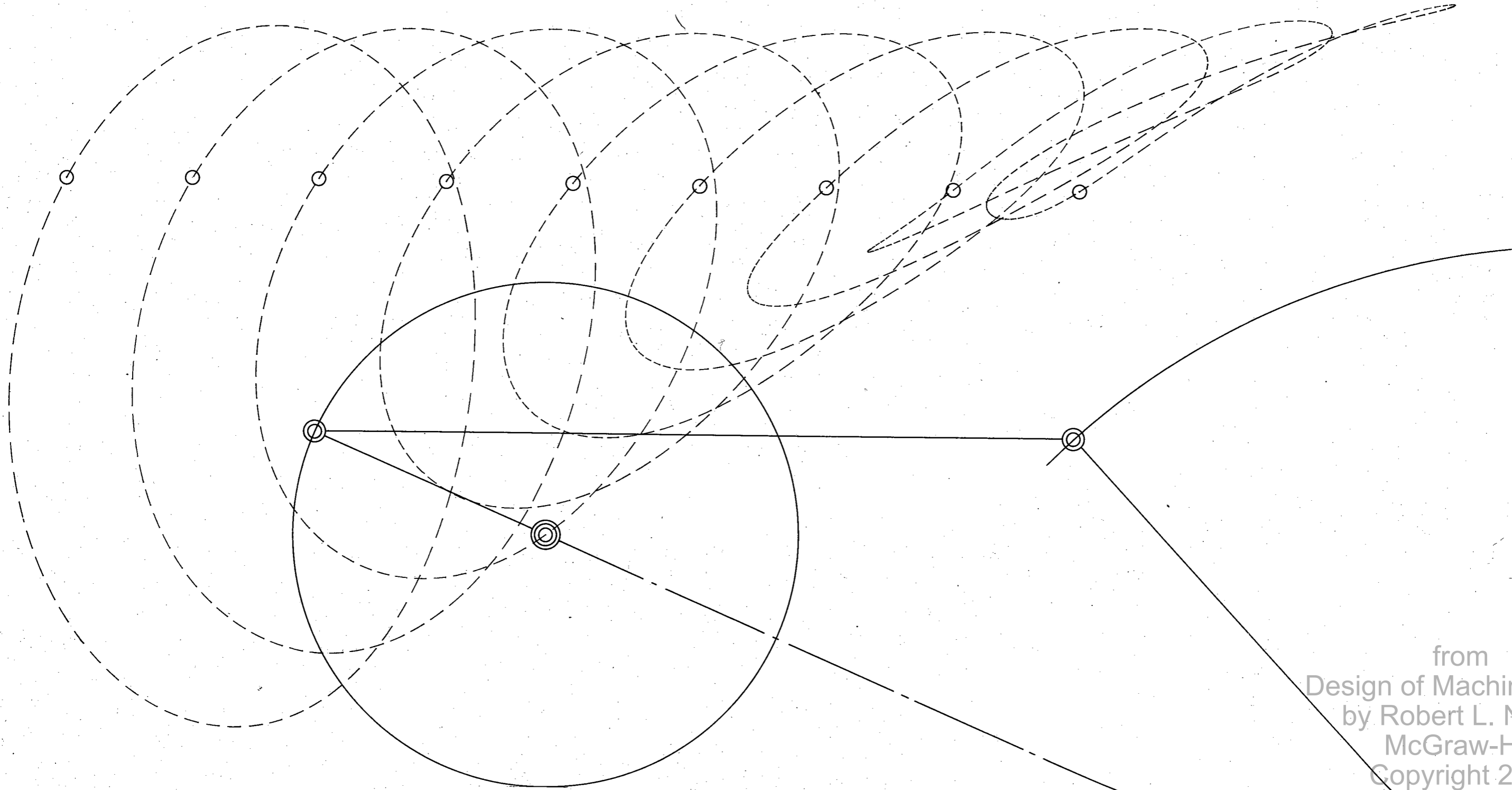
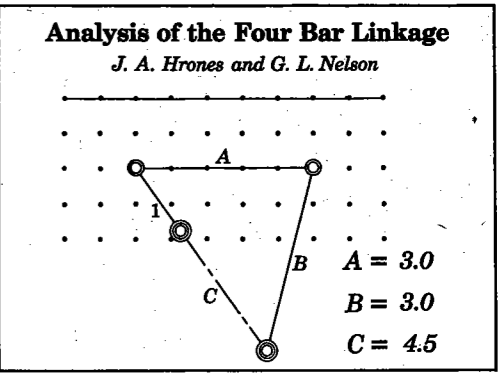

from  
Design of Machinery 4ed  
by Robert L. Norton  
McGraw-Hill  
Copyright 2008

**Analysis of the Four Bar Linkage**  
*J. A. Hrones and G. L. Nelson*

$A = 3.0$   
 $B = 3.0$   
 $C = 4.5$

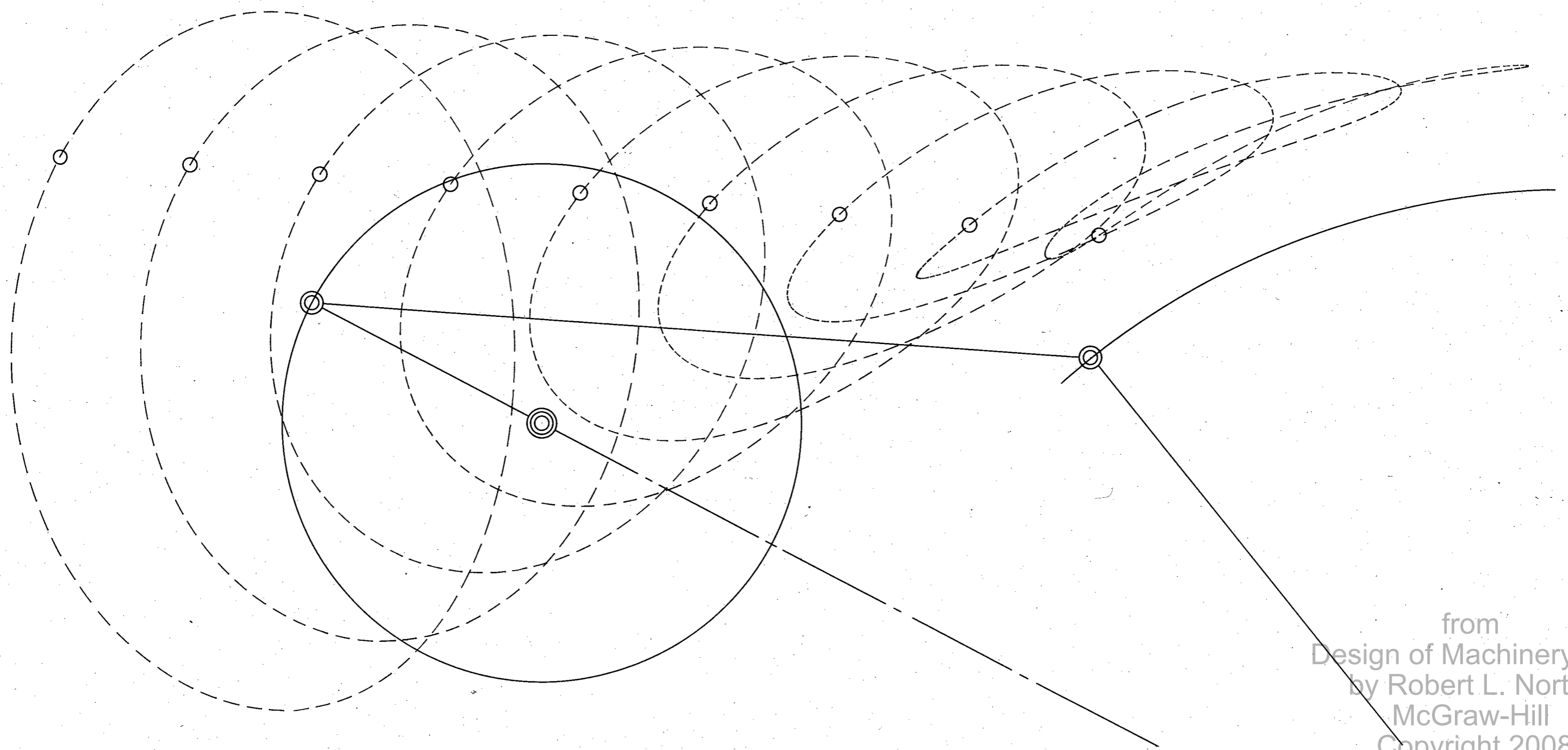

from  
 Design of Machinery 4ed  
 by Robert L. Norton  
 McGraw-Hill  
 Copyright 2008

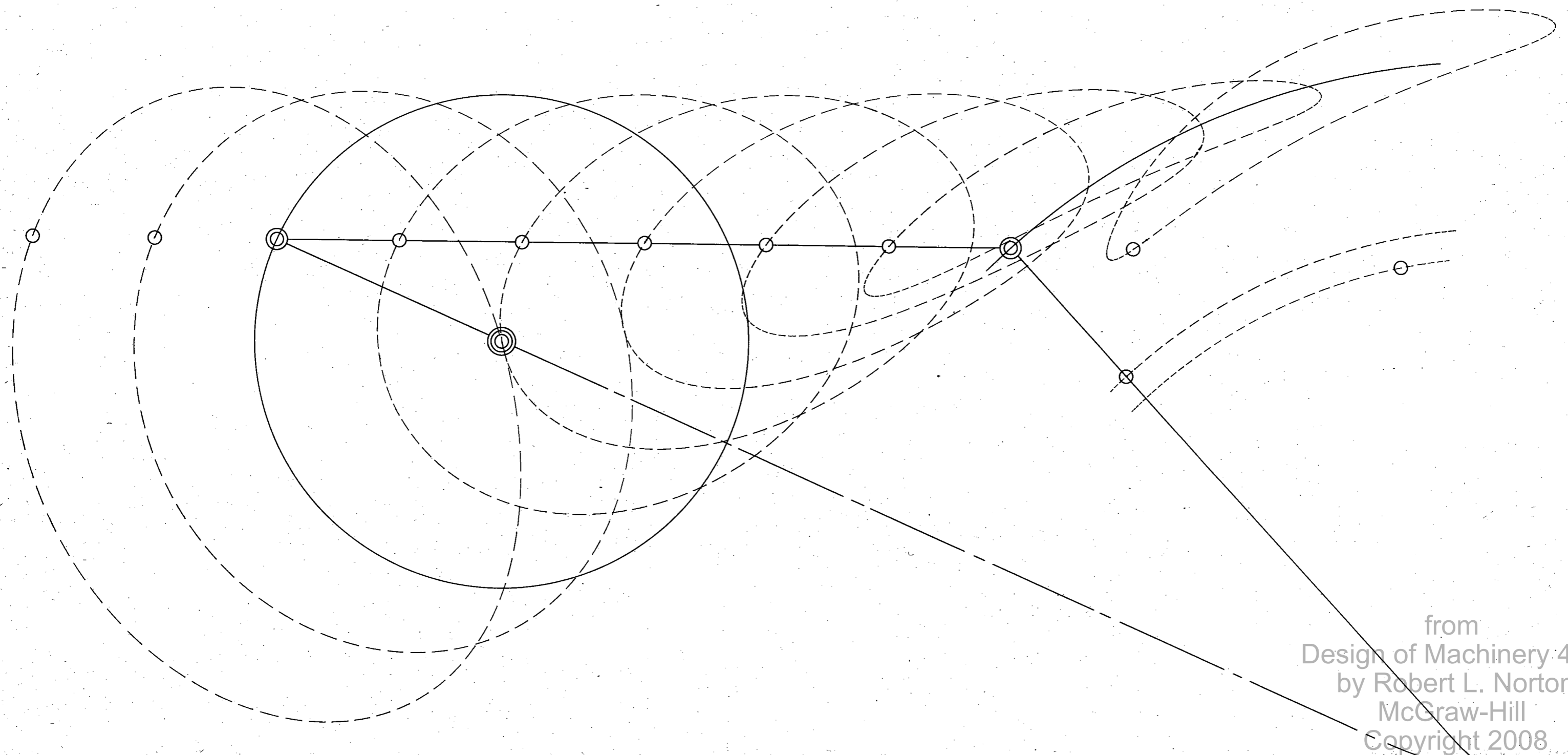
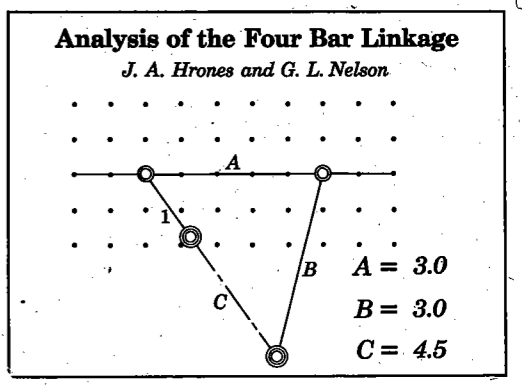

from  
Design of Machinery 4ed  
by Robert L. Norton  
McGraw-Hill  
Copyright 2008

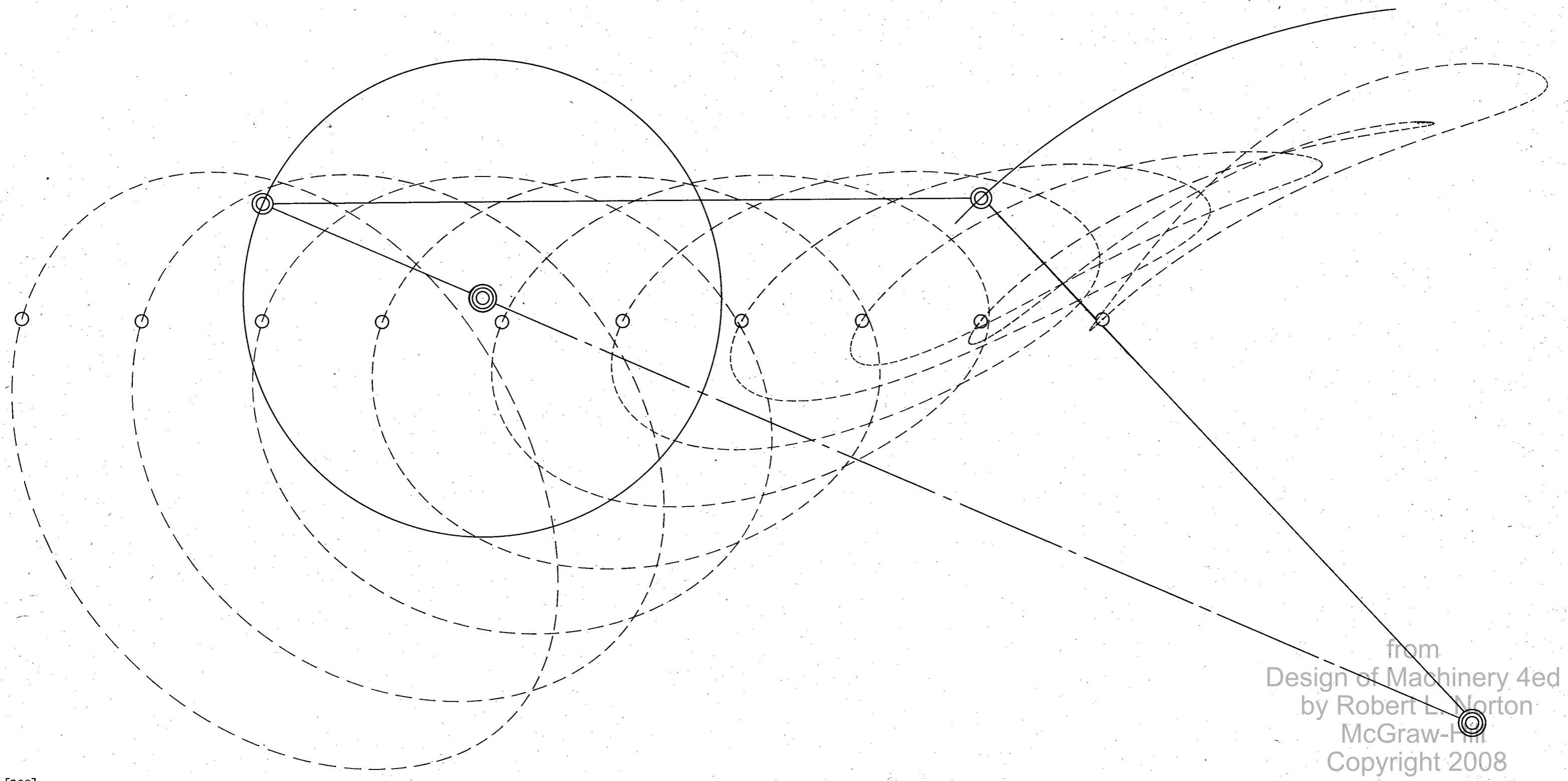
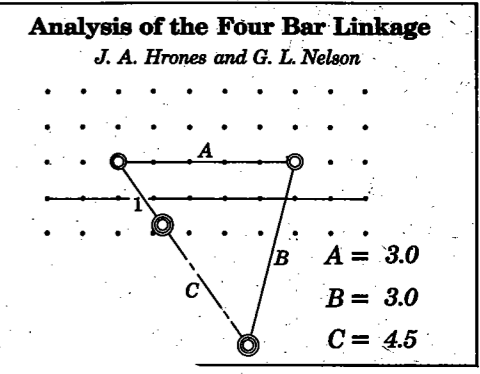

from  
 Design of Machinery 4ed  
 by Robert L. Norton  
 McGraw-Hill  
 Copyright 2008

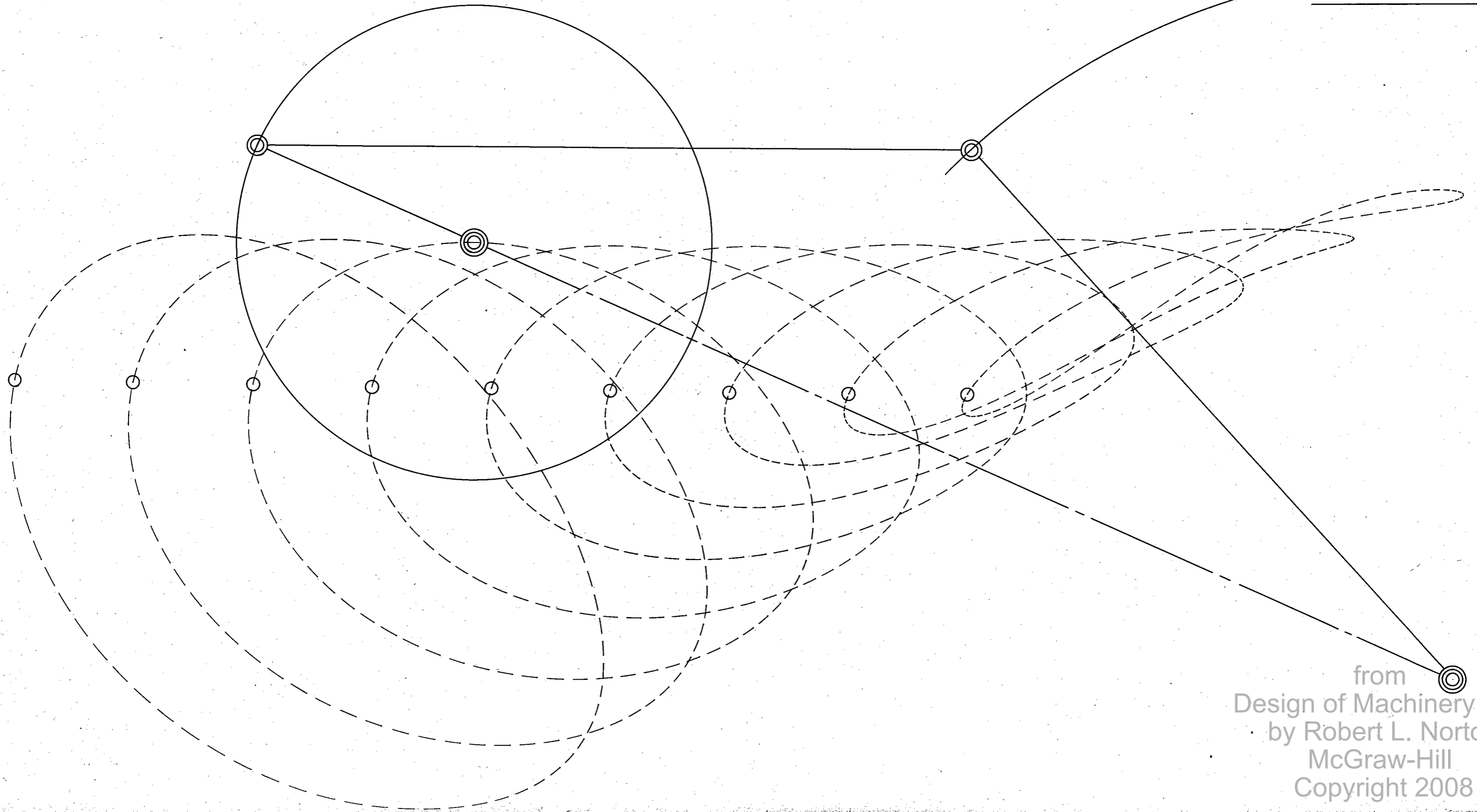
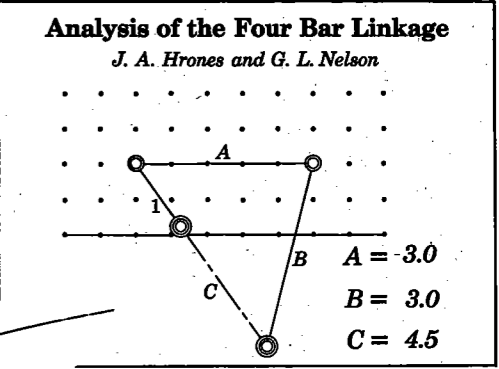

from  
Design of Machinery 4ed  
by Robert L. Norton  
McGraw-Hill  
Copyright 2008

**Analysis of the Four Bar Linkage**

*J. A. Hrones and G. L. Nelson*

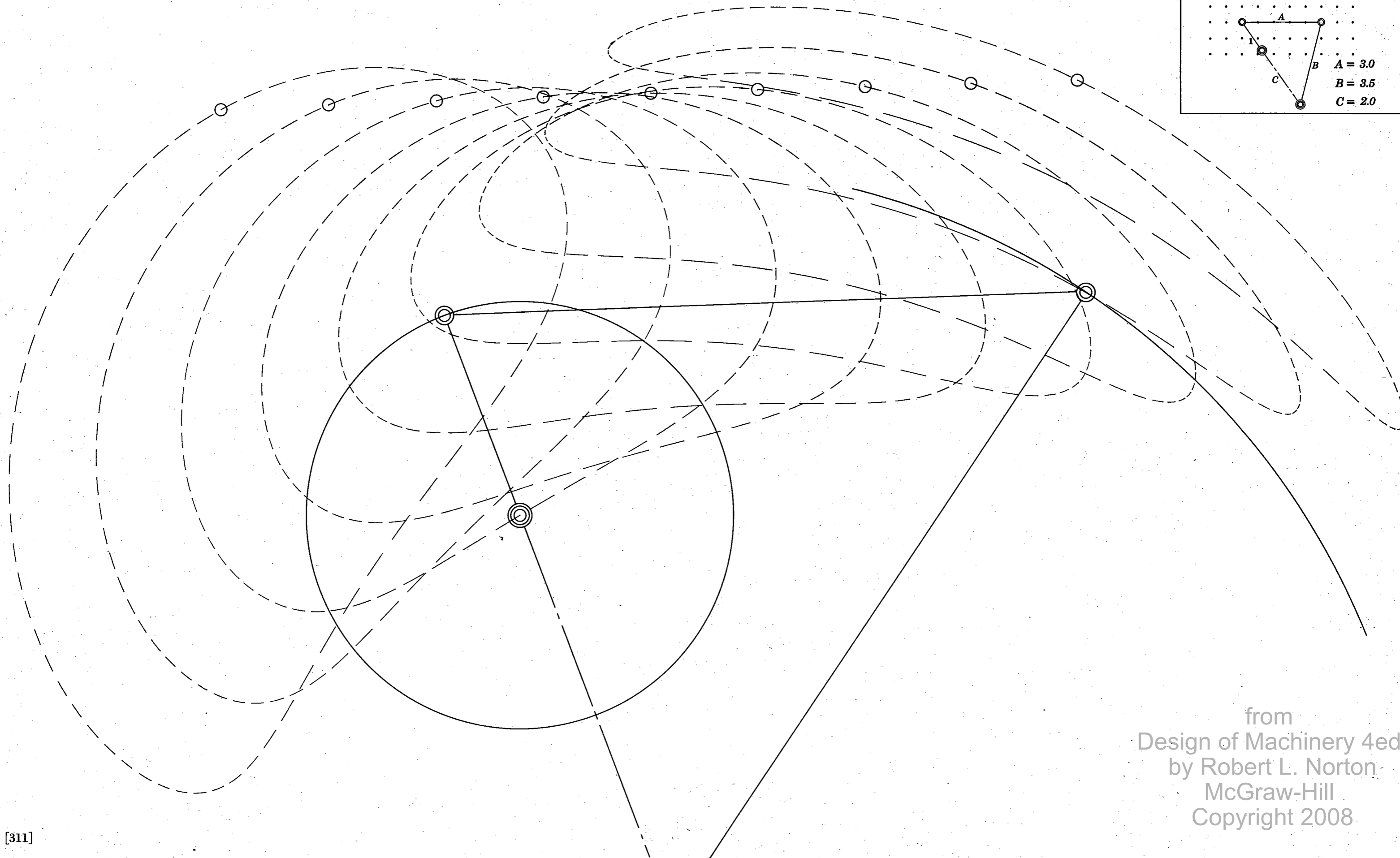
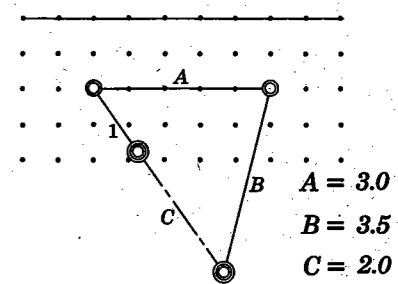

from  
Design of Machinery 4ed  
by Robert L. Norton  
McGraw-Hill  
Copyright 2008

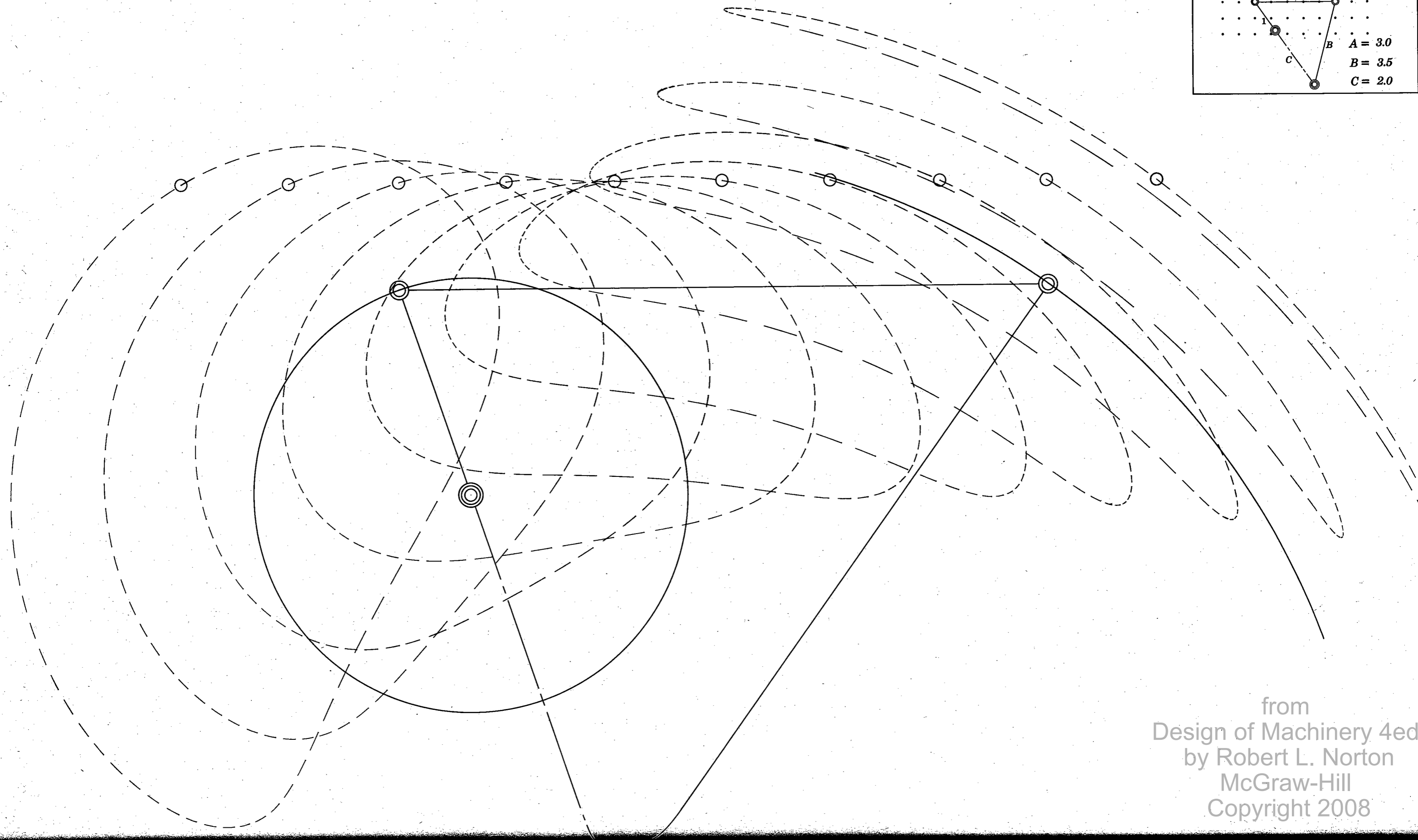
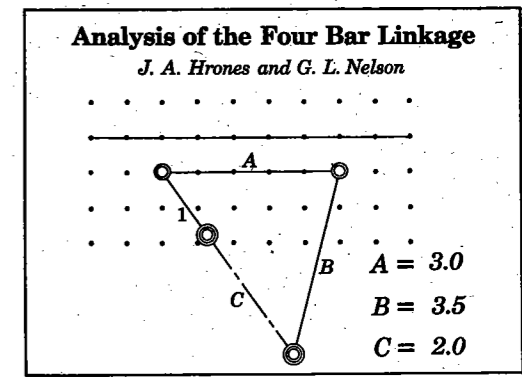

from  
Design of Machinery 4ed  
by Robert L. Norton  
McGraw-Hill  
Copyright 2008

**Analysis of the Four Bar Linkage**

*J. A. Hrones and G. L. Nelson*

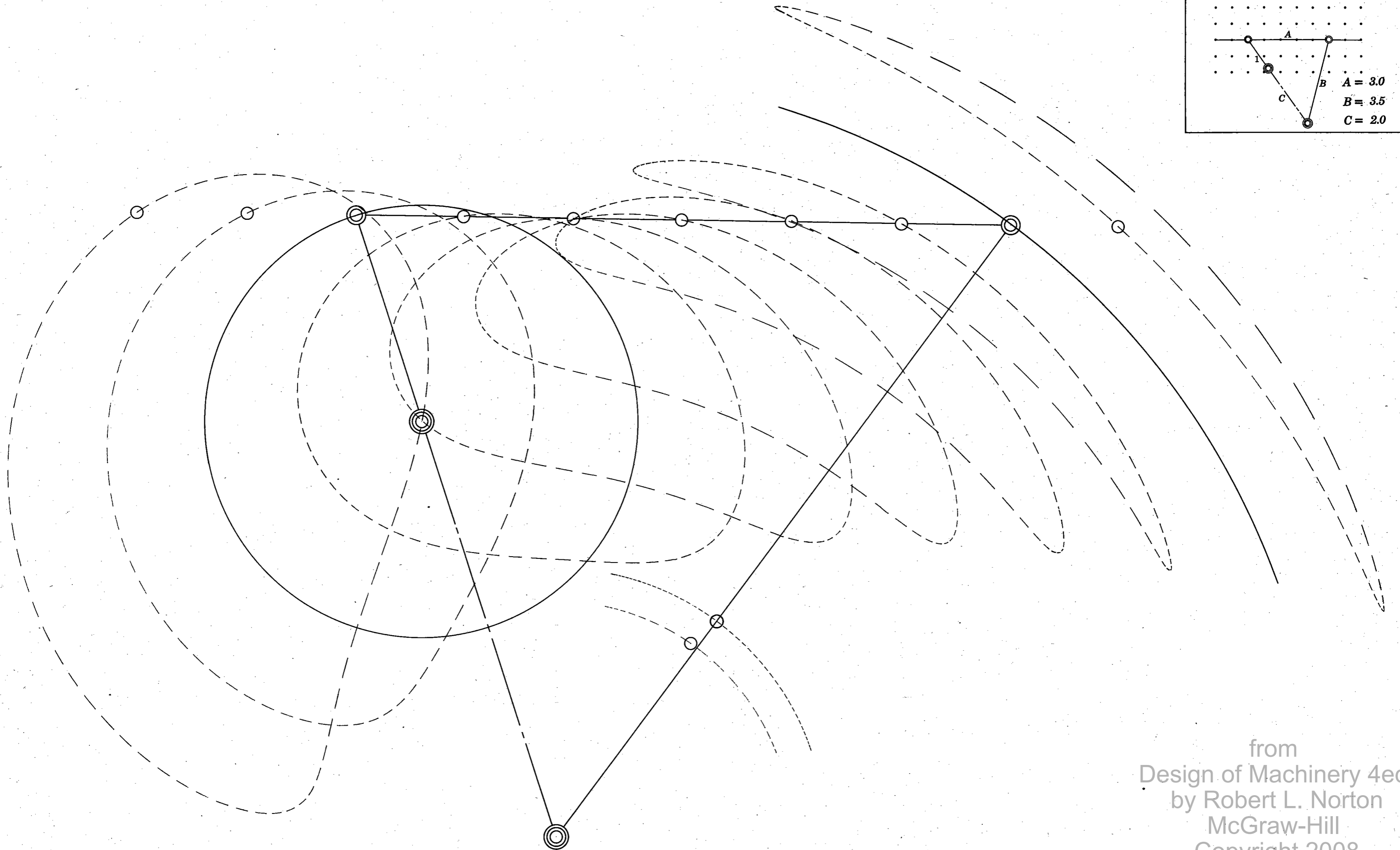
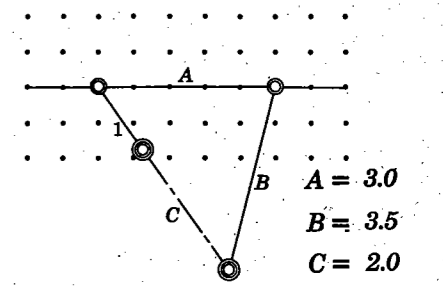

from  
Design of Machinery 4ed  
by Robert L. Norton  
McGraw-Hill  
Copyright 2008



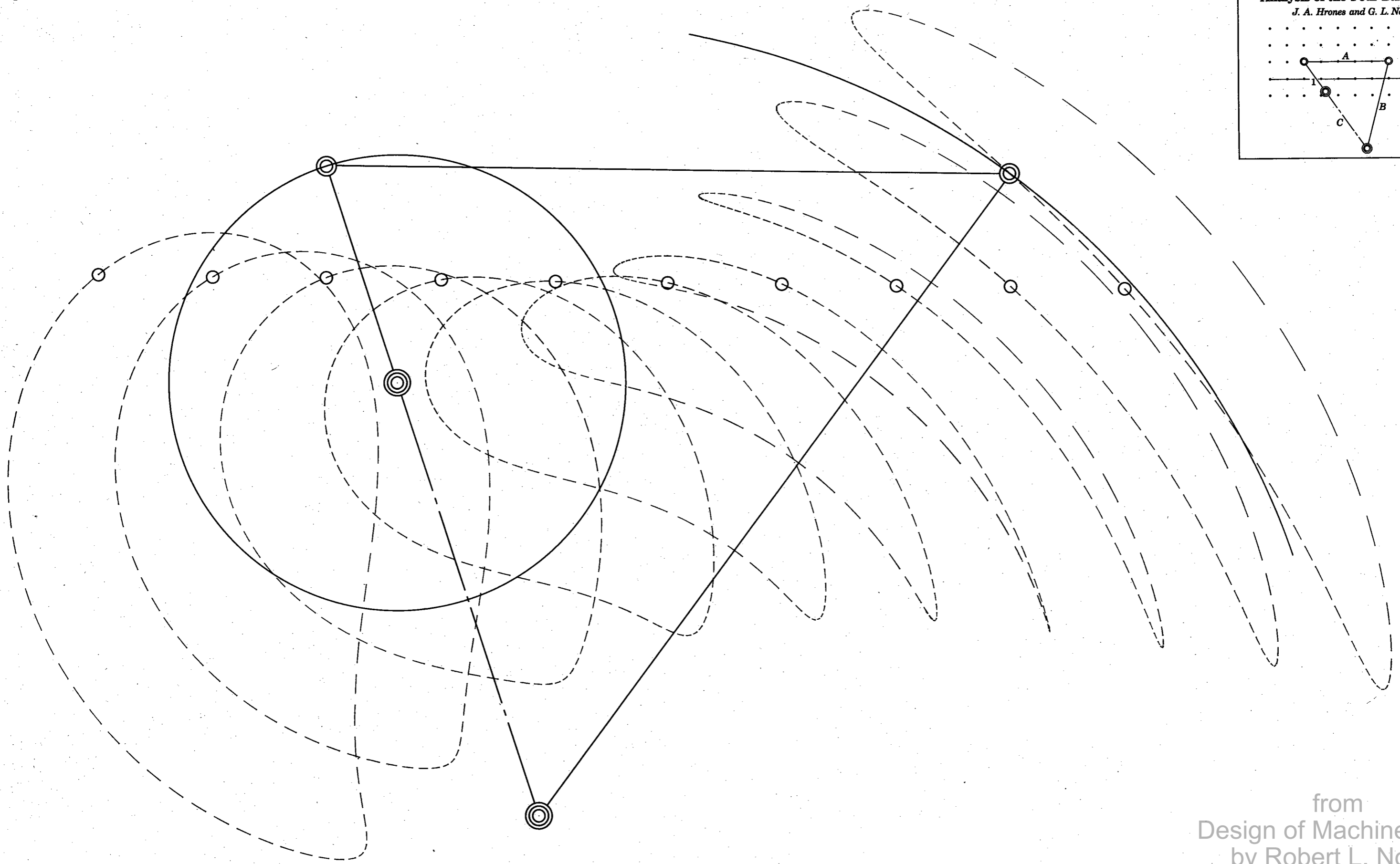
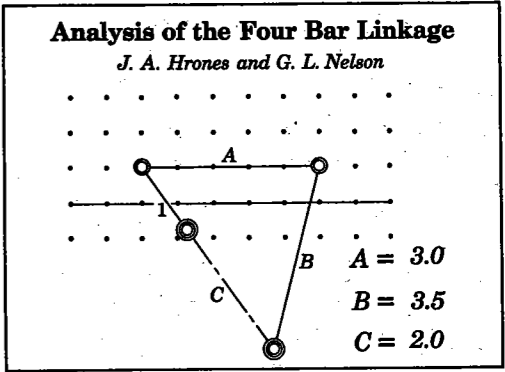

from  
Design of Machinery 4ed  
by Robert L. Norton  
McGraw-Hill  
Copyright 2008

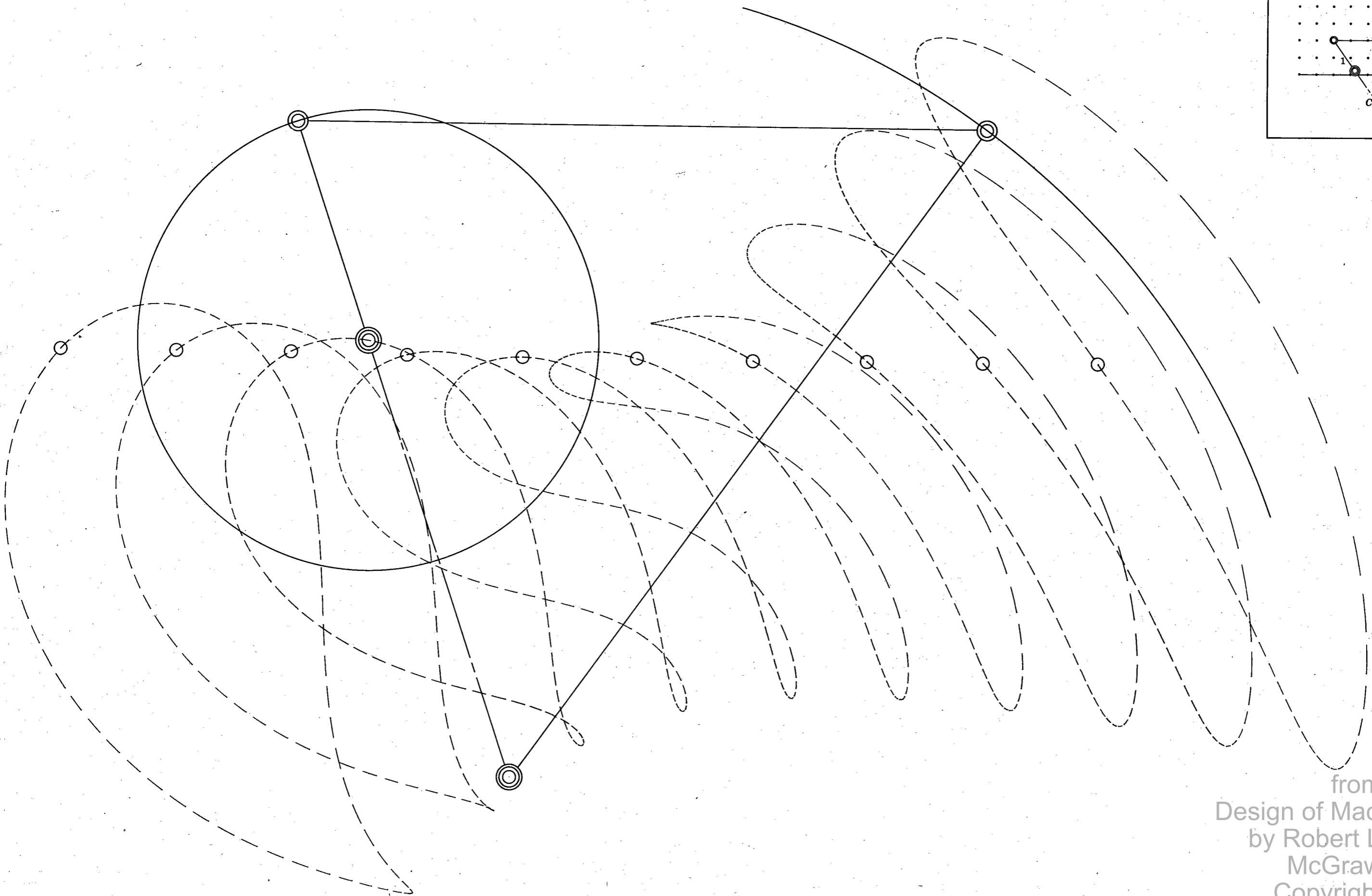
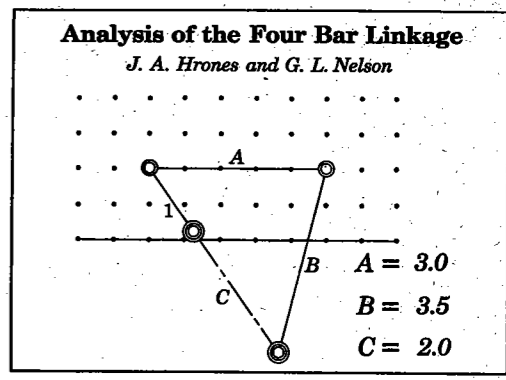

from  
 Design of Machinery 4ed  
 by Robert L. Norton  
 McGraw-Hill  
 Copyright 2008

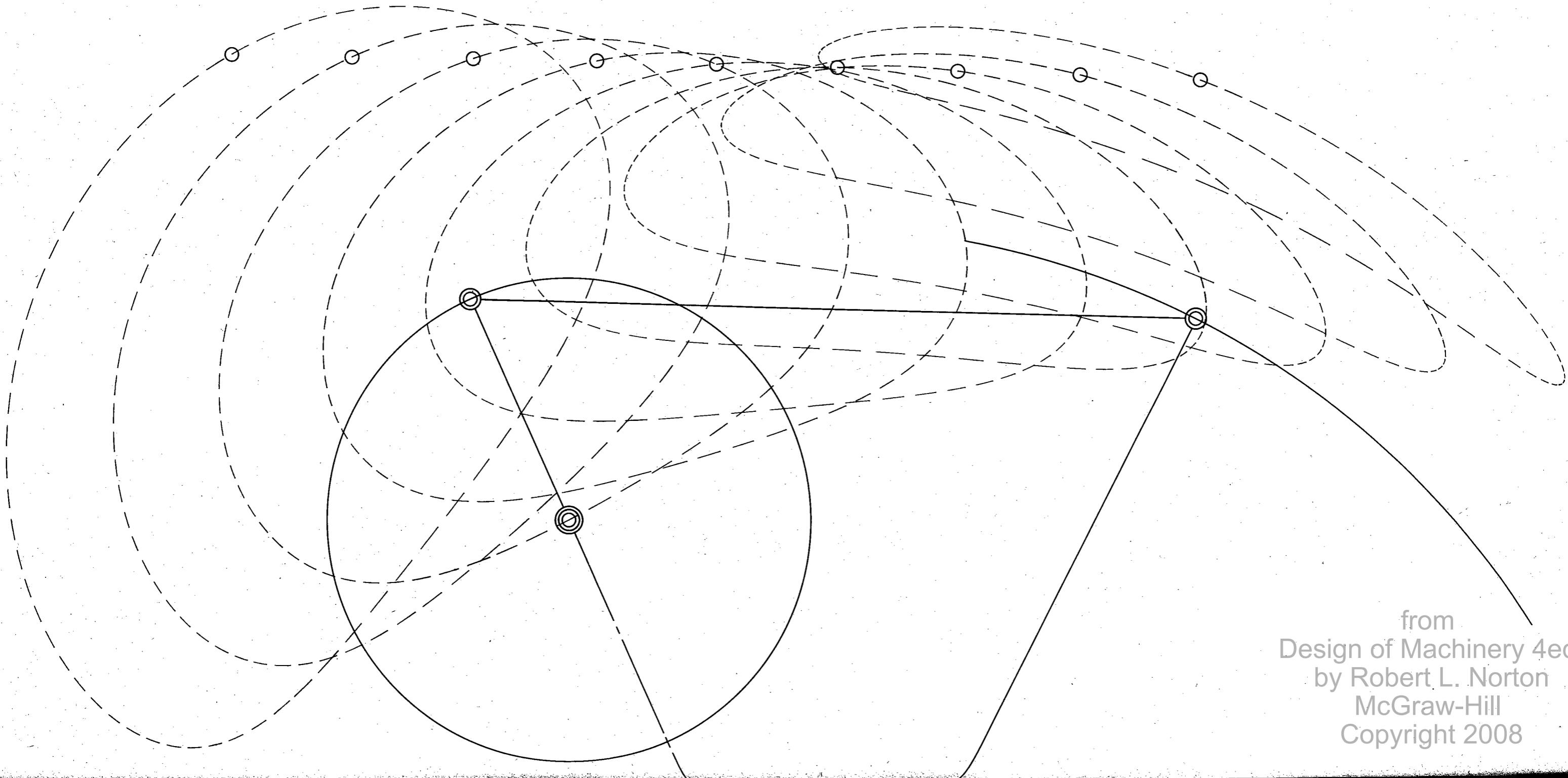
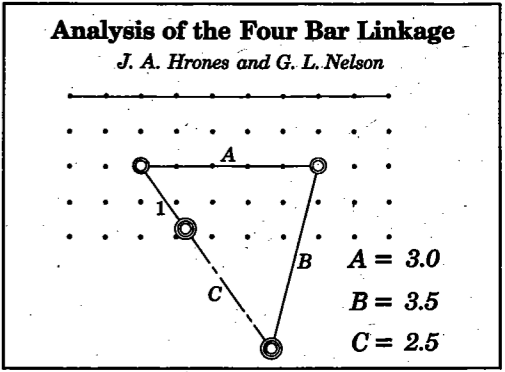

from  
Design of Machinery 4ed  
by Robert L. Norton  
McGraw-Hill  
Copyright 2008

**Analysis of the Four Bar Linkage**  
*J. A. Hrones and G. L. Nelson*

$A = 3.0$   
 $B = 3.5$   
 $C = 2.5$

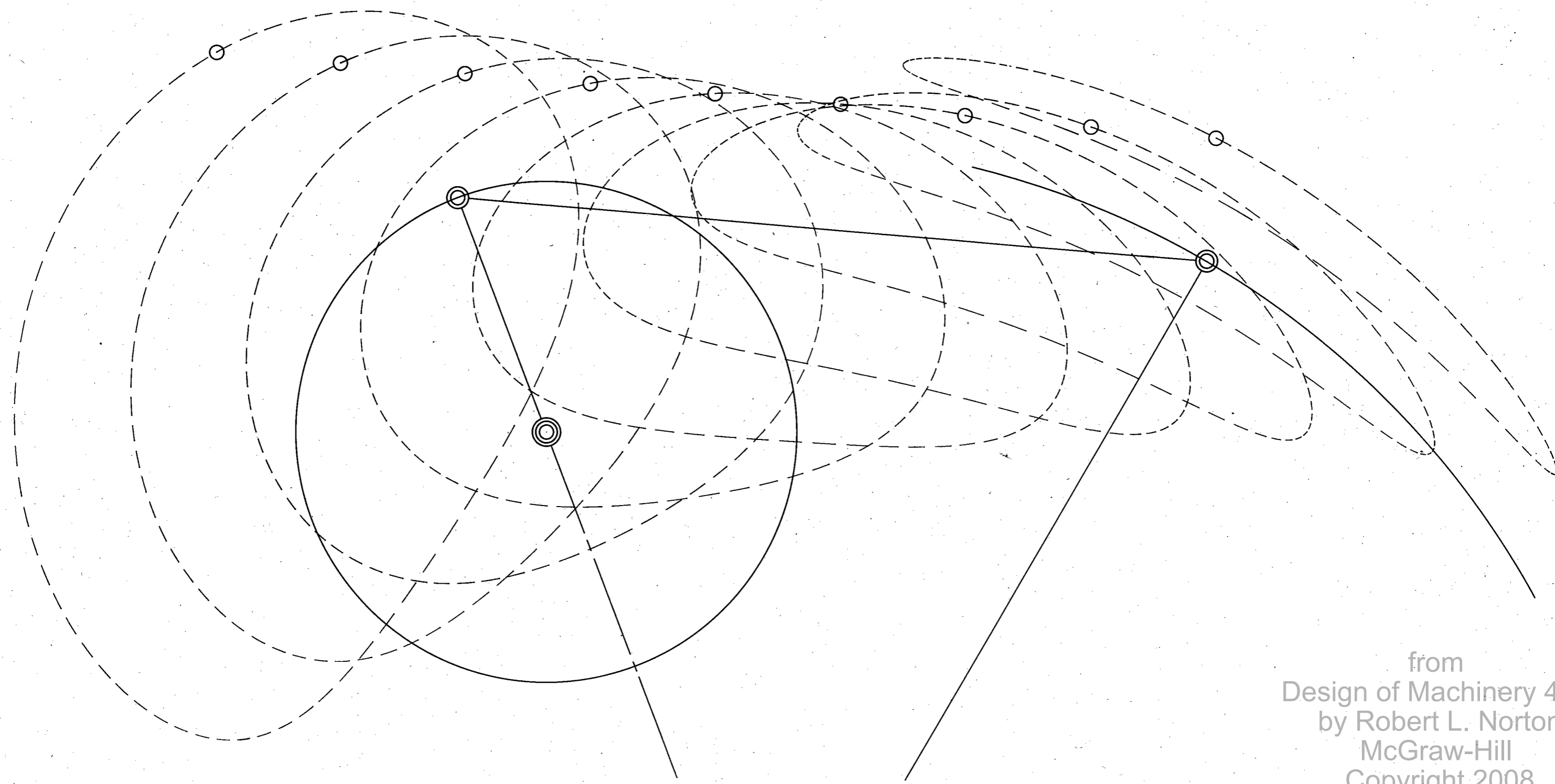

from  
 Design of Machinery 4ed  
 by Robert L. Norton  
 McGraw-Hill  
 Copyright 2008

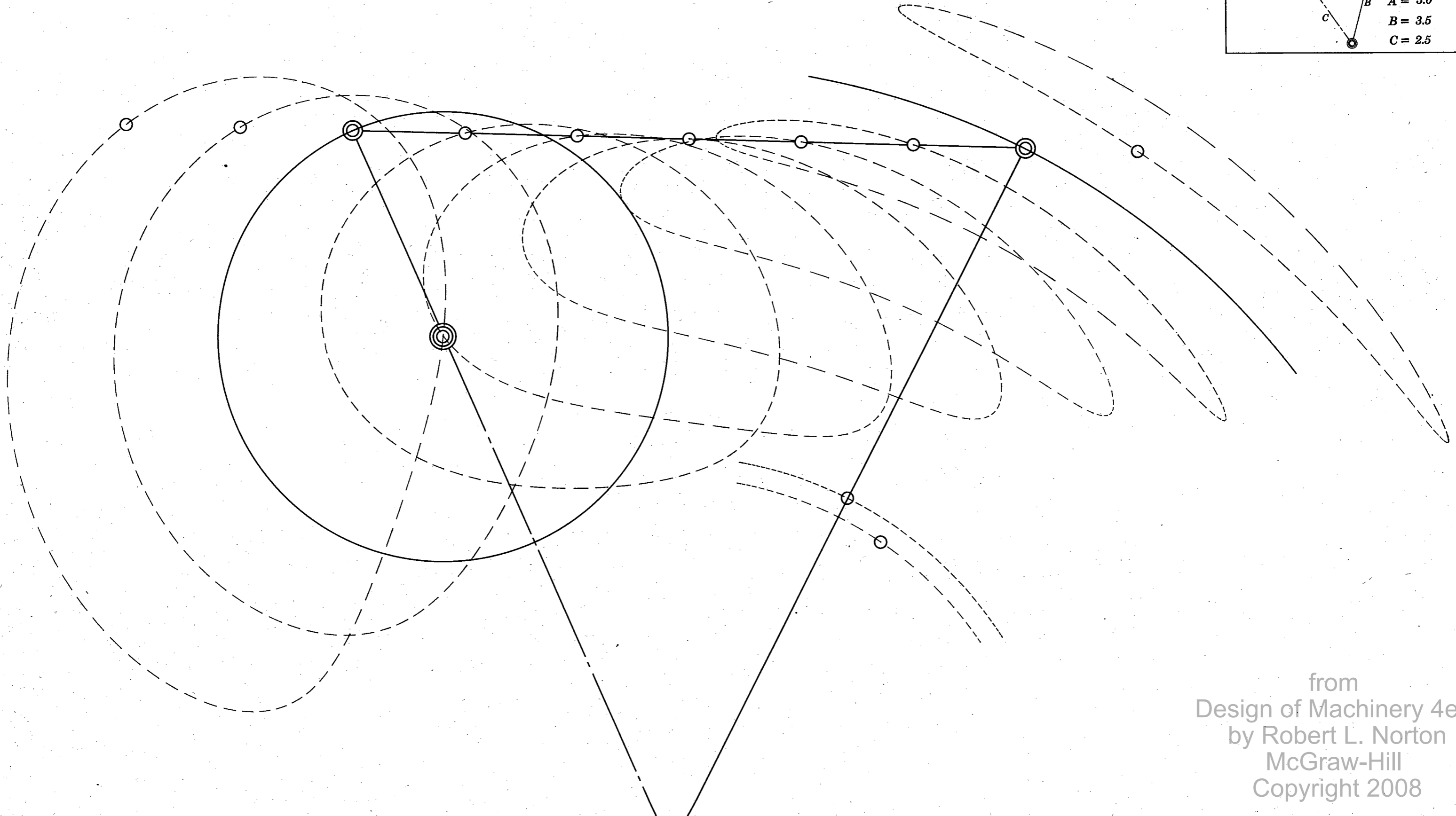
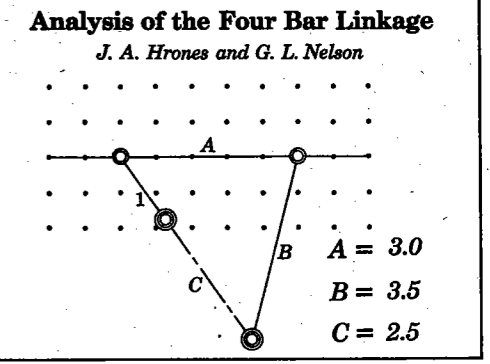

from  
Design of Machinery 4ed  
by Robert L. Norton  
McGraw-Hill  
Copyright 2008

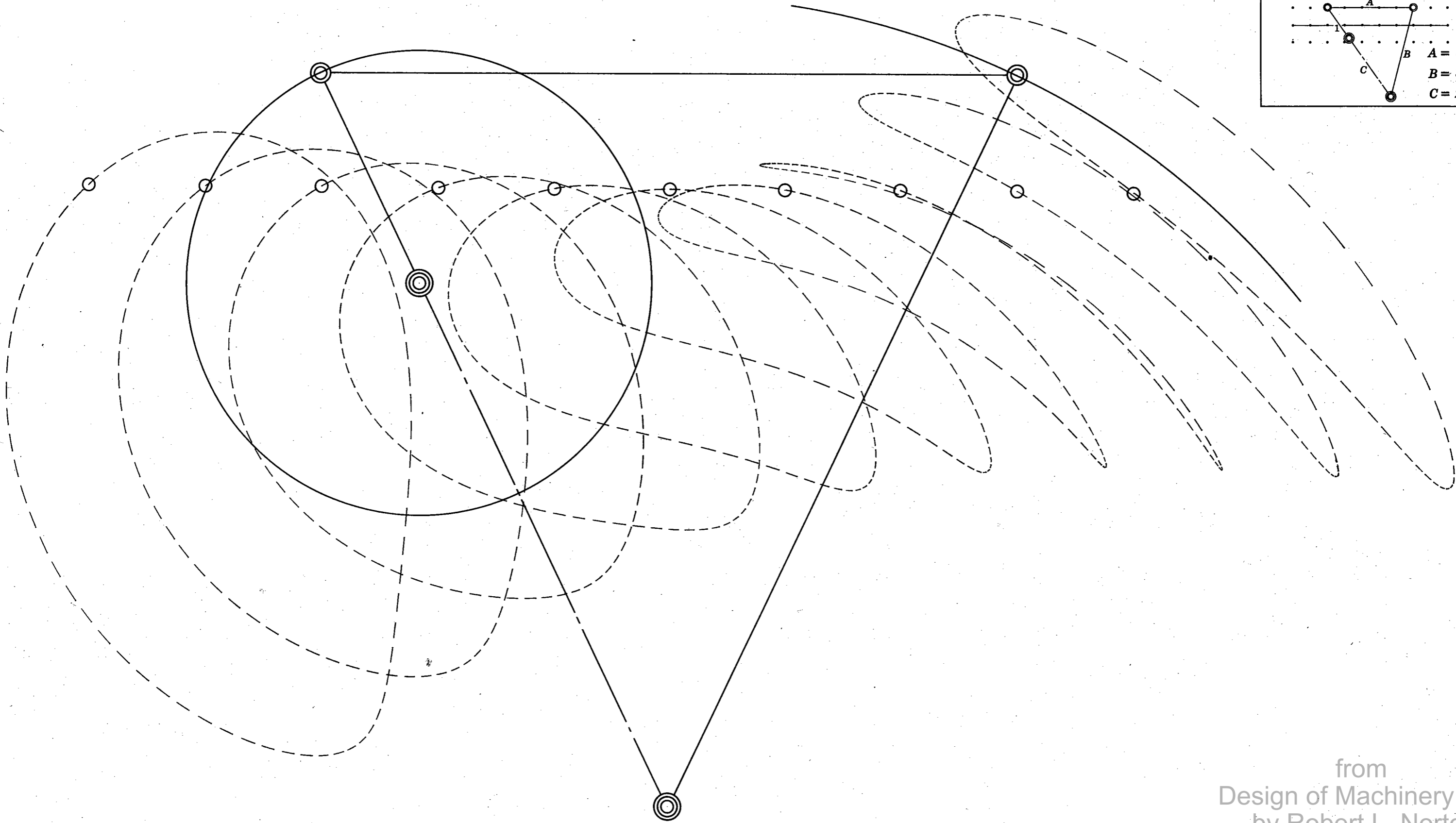
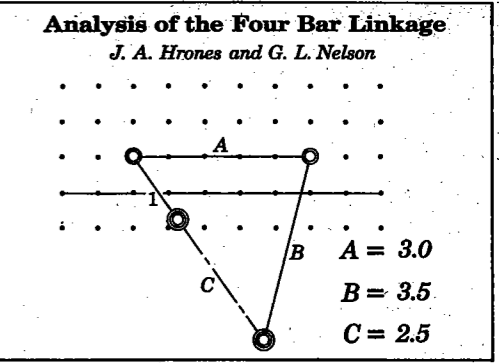

from  
 Design of Machinery 4ed  
 by Robert L. Norton  
 McGraw-Hill  
 Copyright 2008

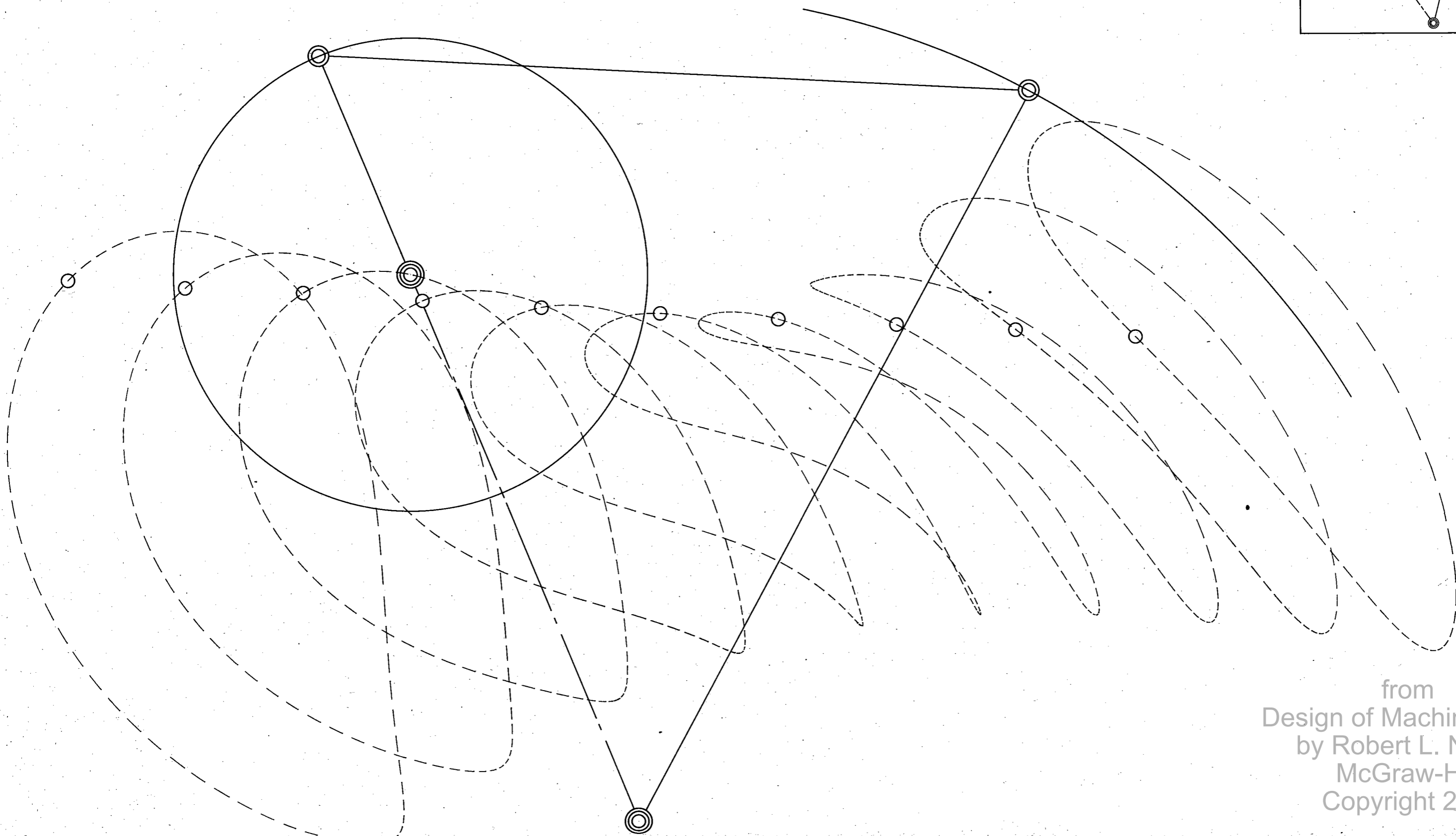
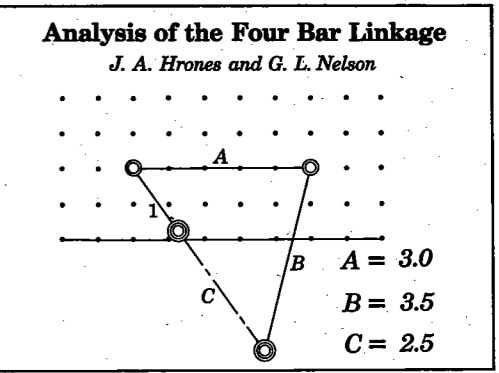

from  
Design of Machinery 4ed  
by Robert L. Norton  
McGraw-Hill  
Copyright 2008

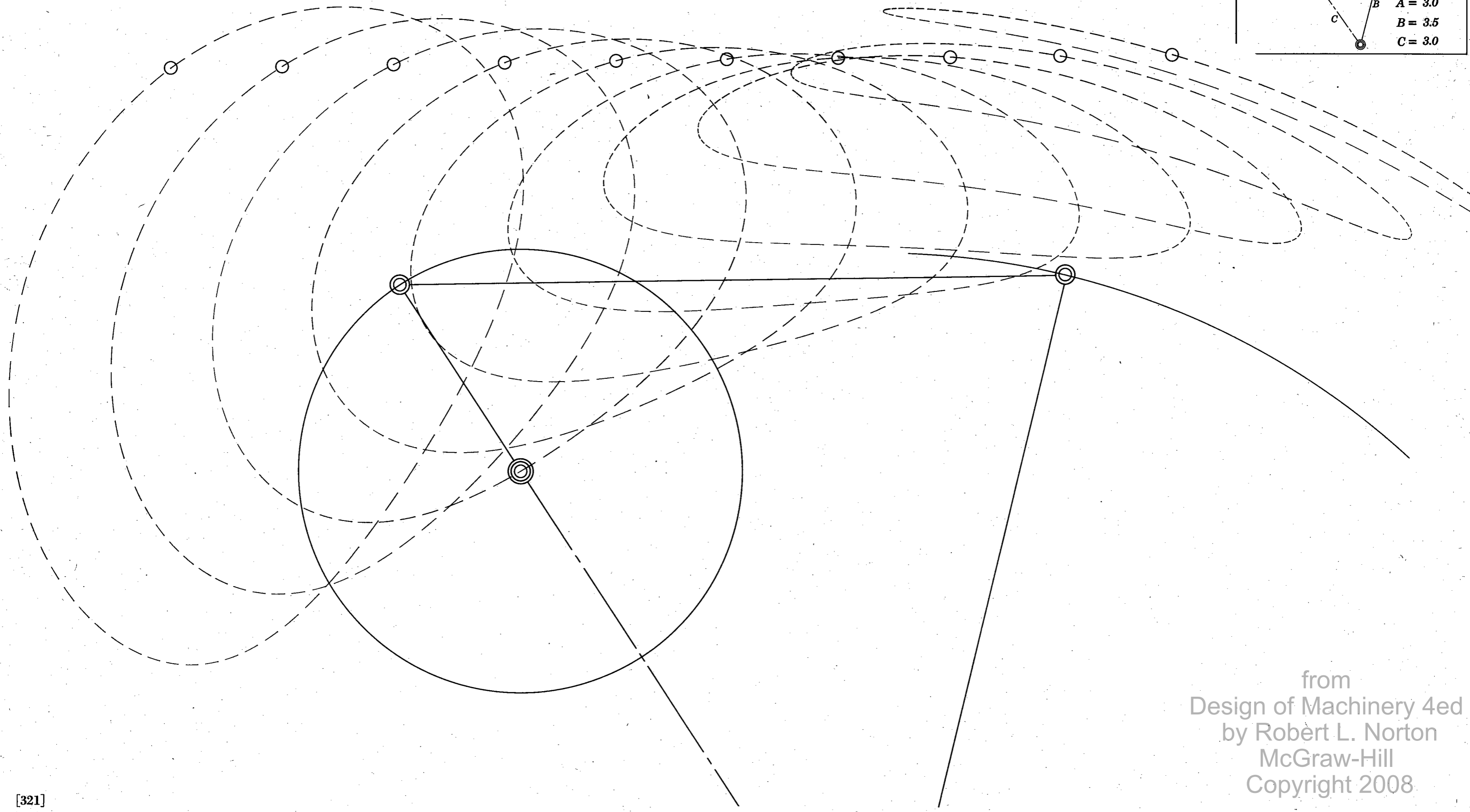
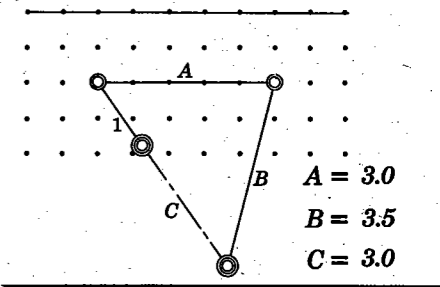

from  
Design of Machinery 4ed  
by Robert L. Norton  
McGraw-Hill  
Copyright 2008



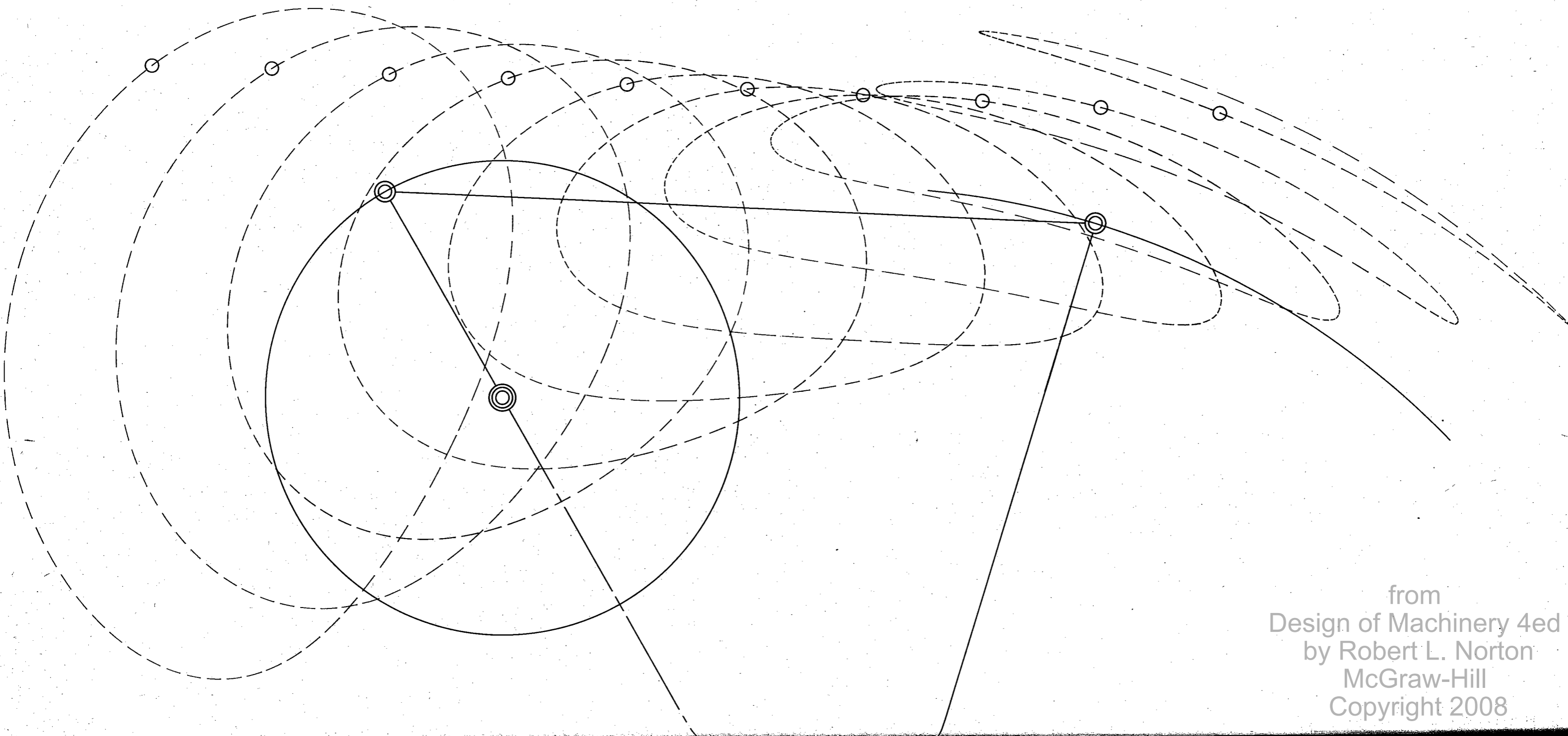
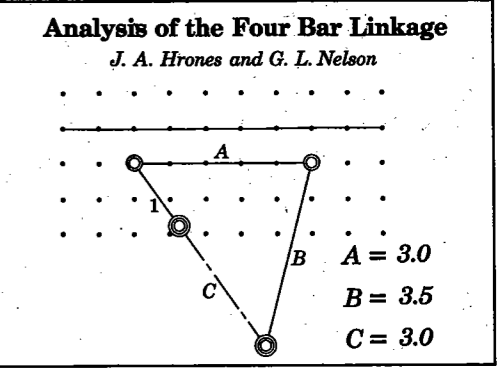

from  
Design of Machinery 4ed  
by Robert L. Norton  
McGraw-Hill  
Copyright 2008

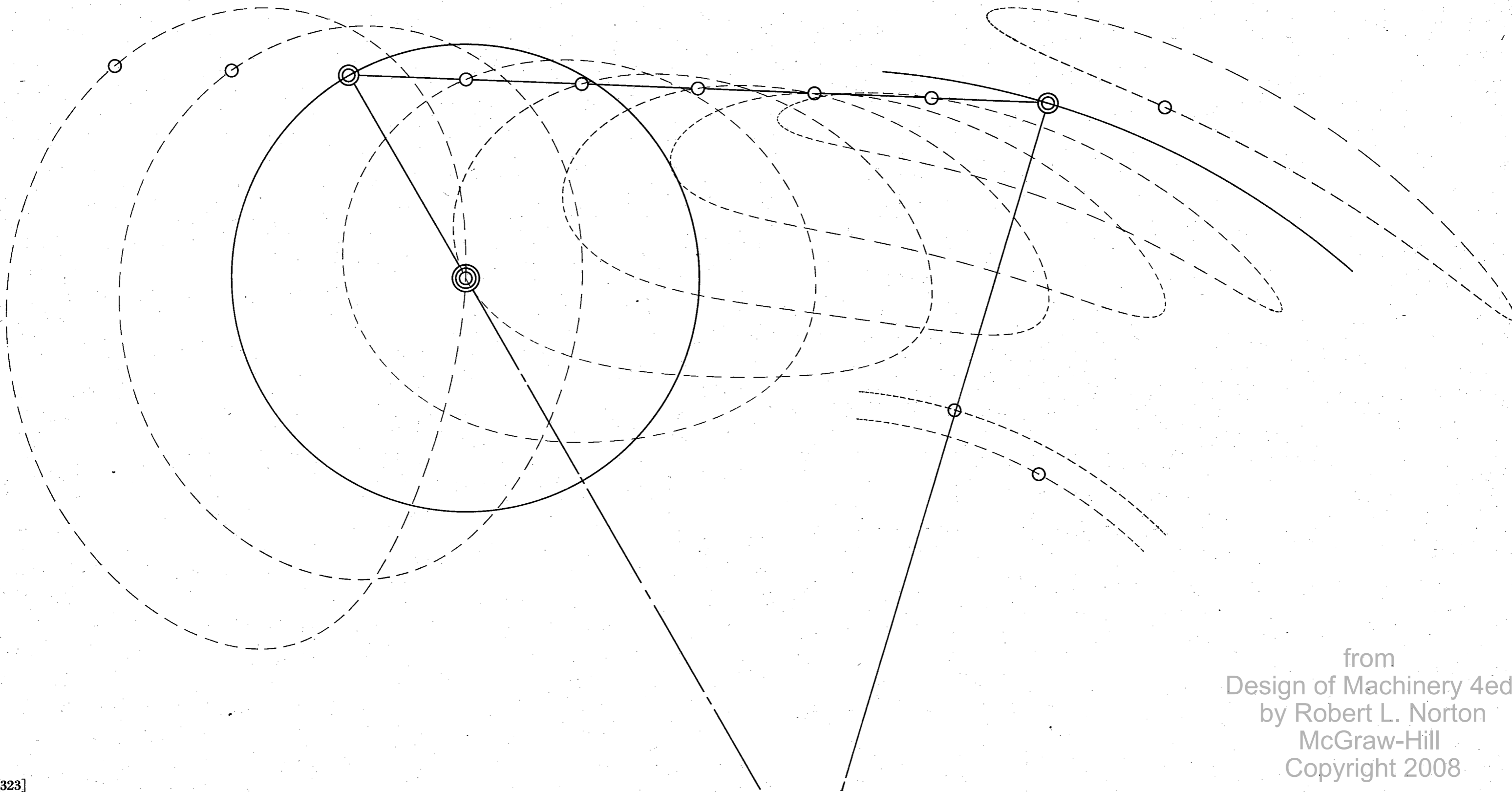
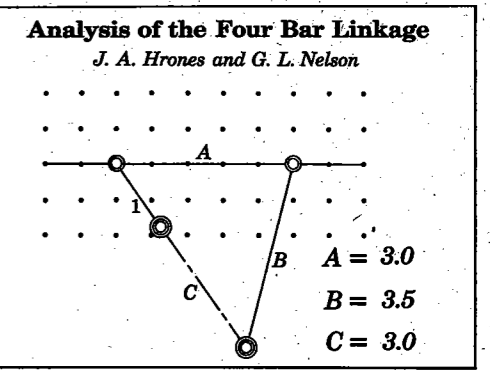

from  
 Design of Machinery 4ed  
 by Robert L. Norton  
 McGraw-Hill  
 Copyright 2008

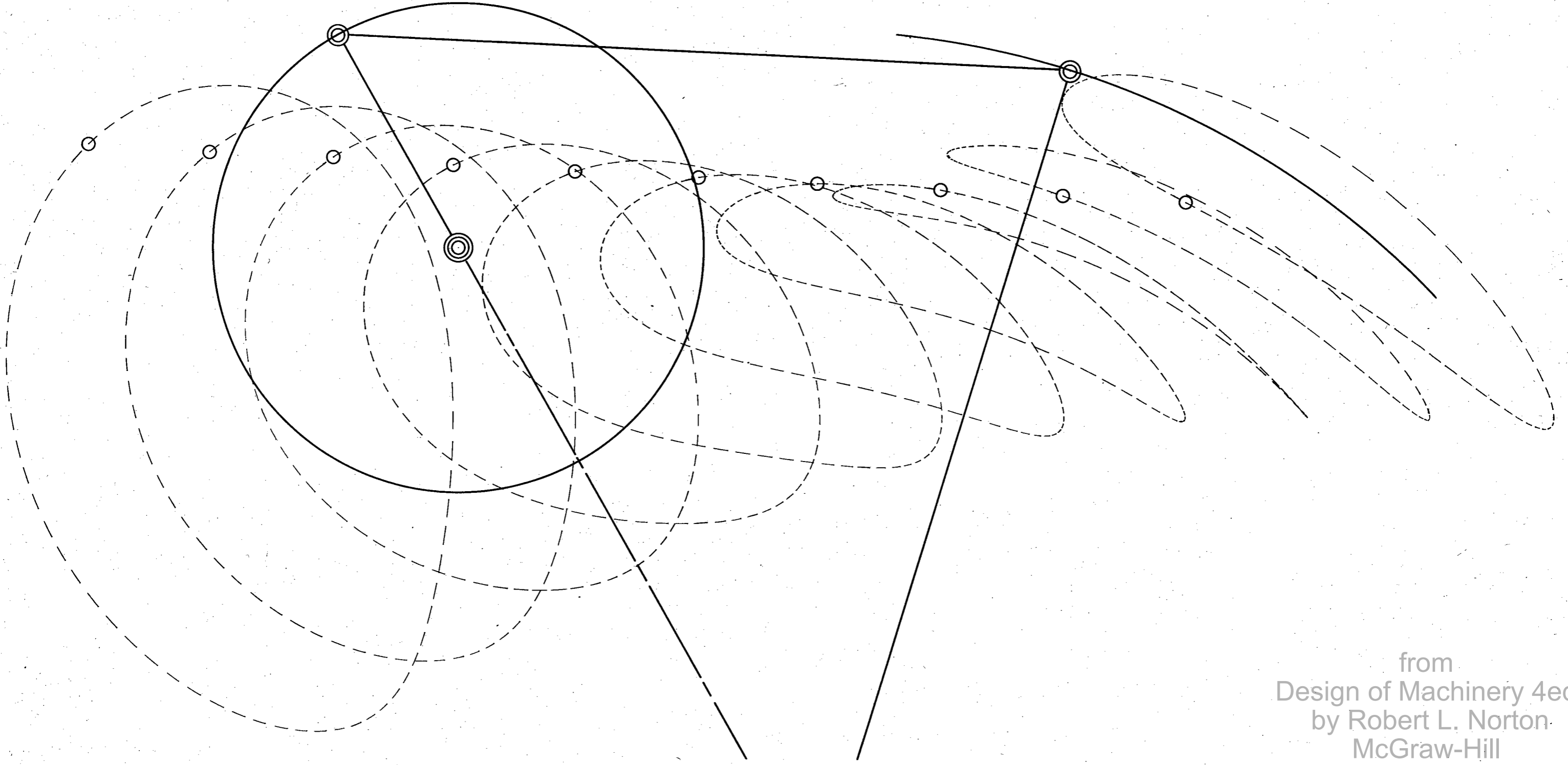
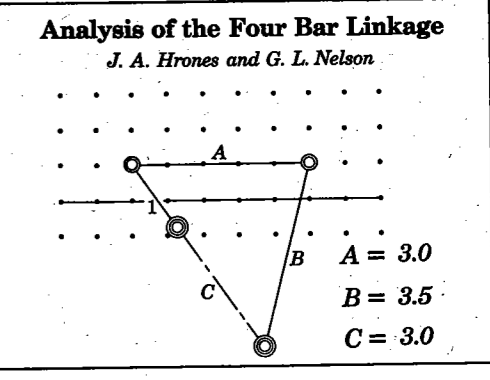

from  
Design of Machinery 4ed  
by Robert L. Norton  
McGraw-Hill  
Copyright 2008

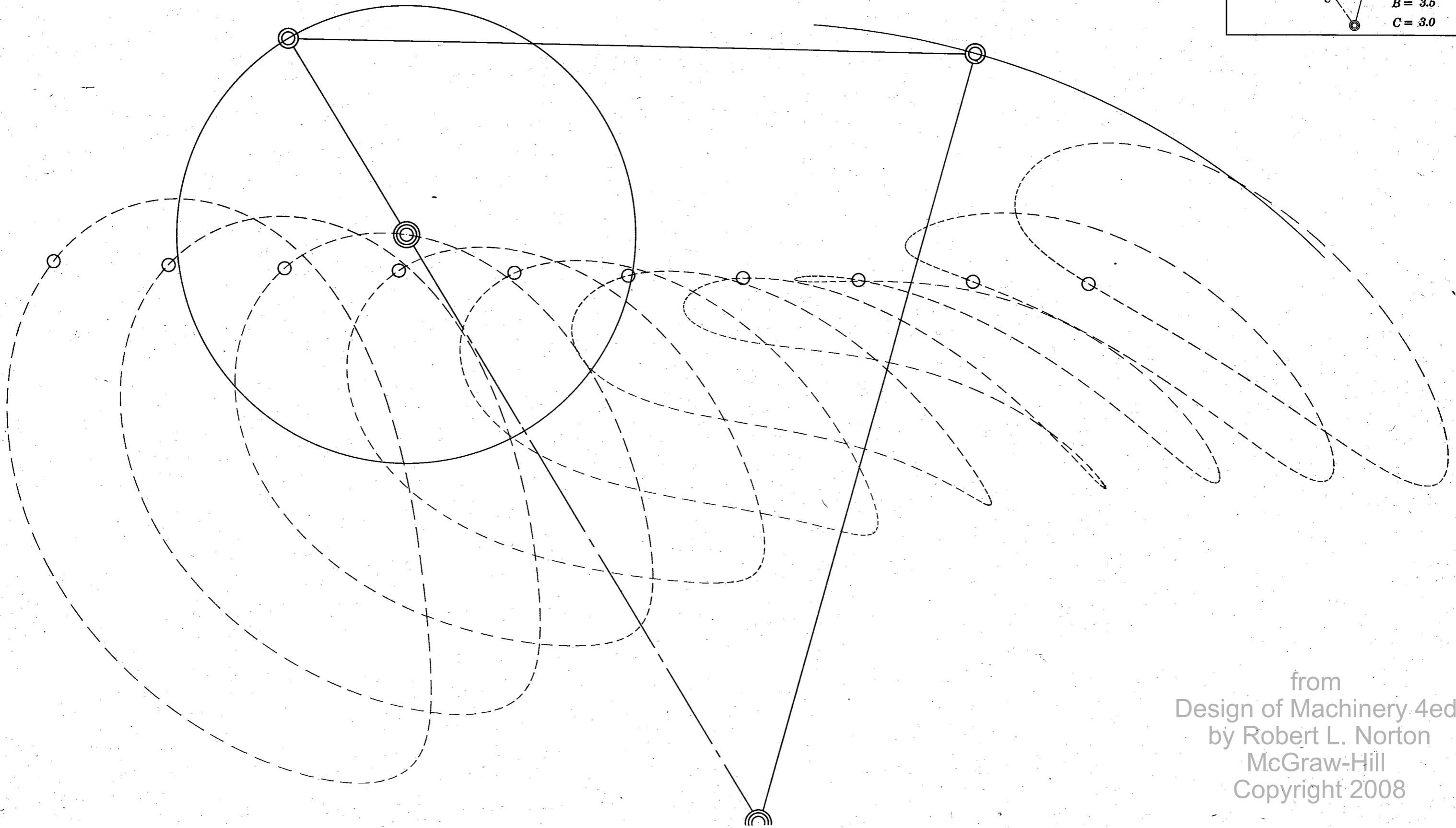
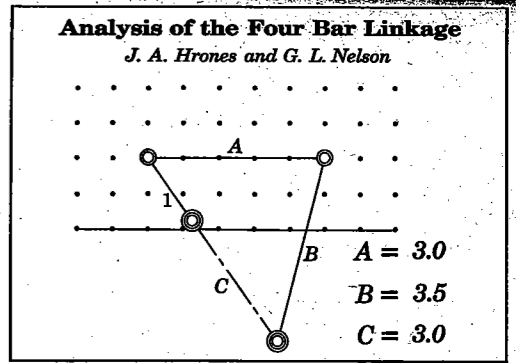

from  
 Design of Machinery 4ed  
 by Robert L. Norton  
 McGraw-Hill  
 Copyright 2008

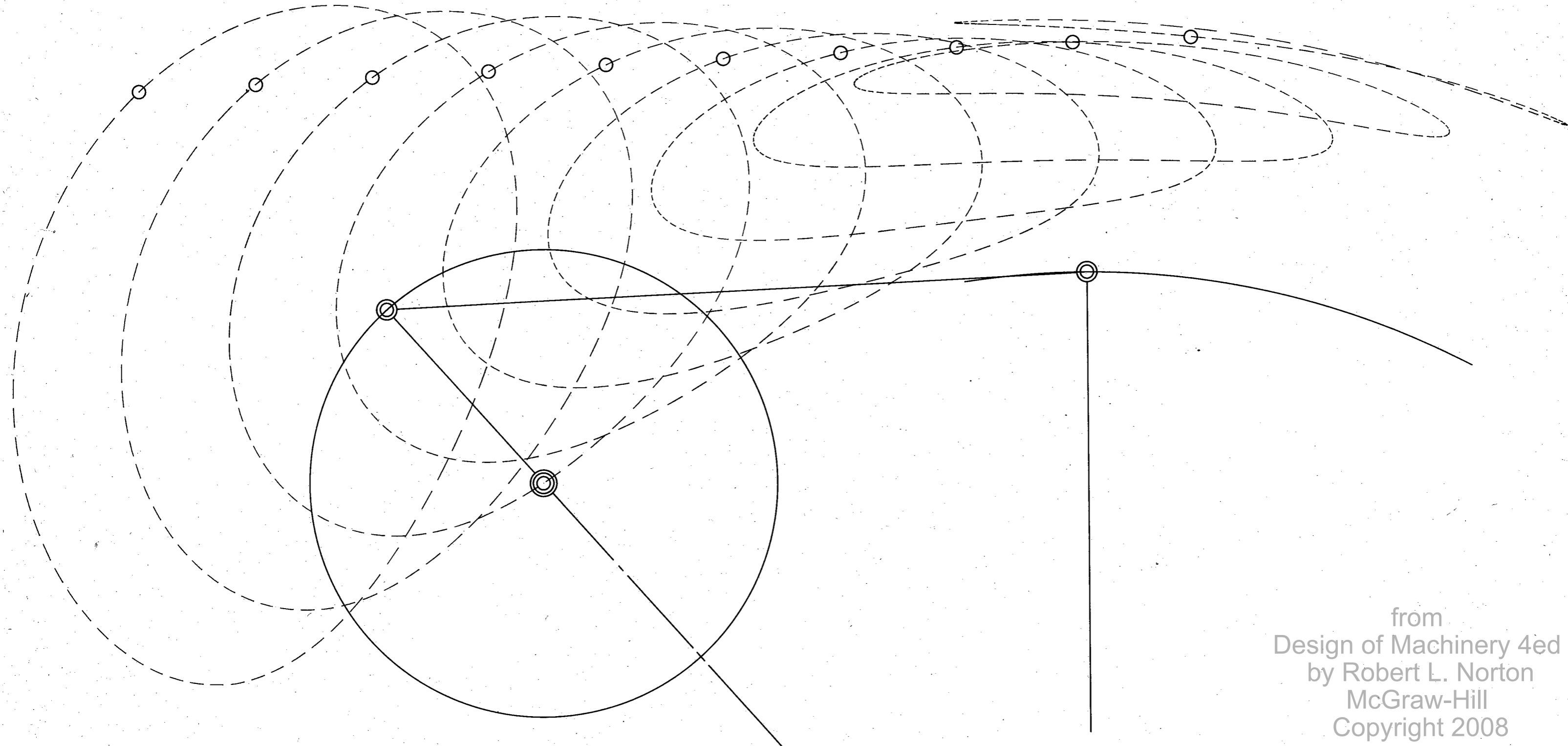
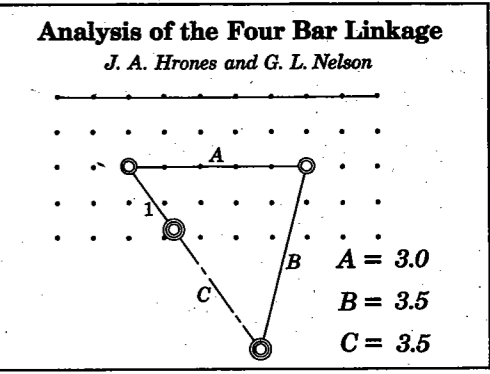

from  
Design of Machinery 4ed  
by Robert L. Norton  
McGraw-Hill  
Copyright 2008

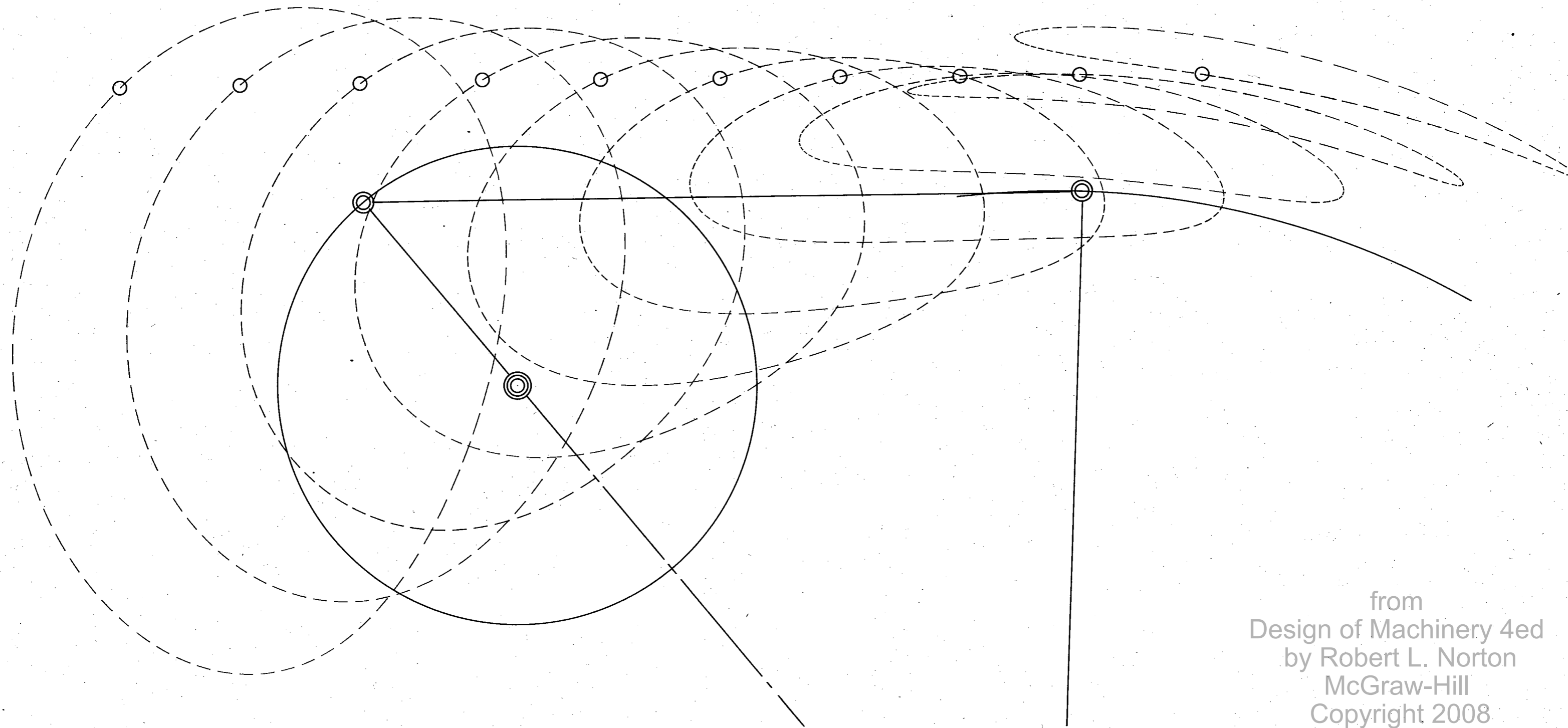
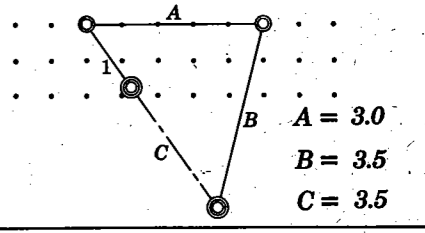

from  
Design of Machinery 4ed  
by Robert L. Norton  
McGraw-Hill  
Copyright 2008

**Analysis of the Four Bar Linkage**

*J. A. Hrones and G. L. Nelson*

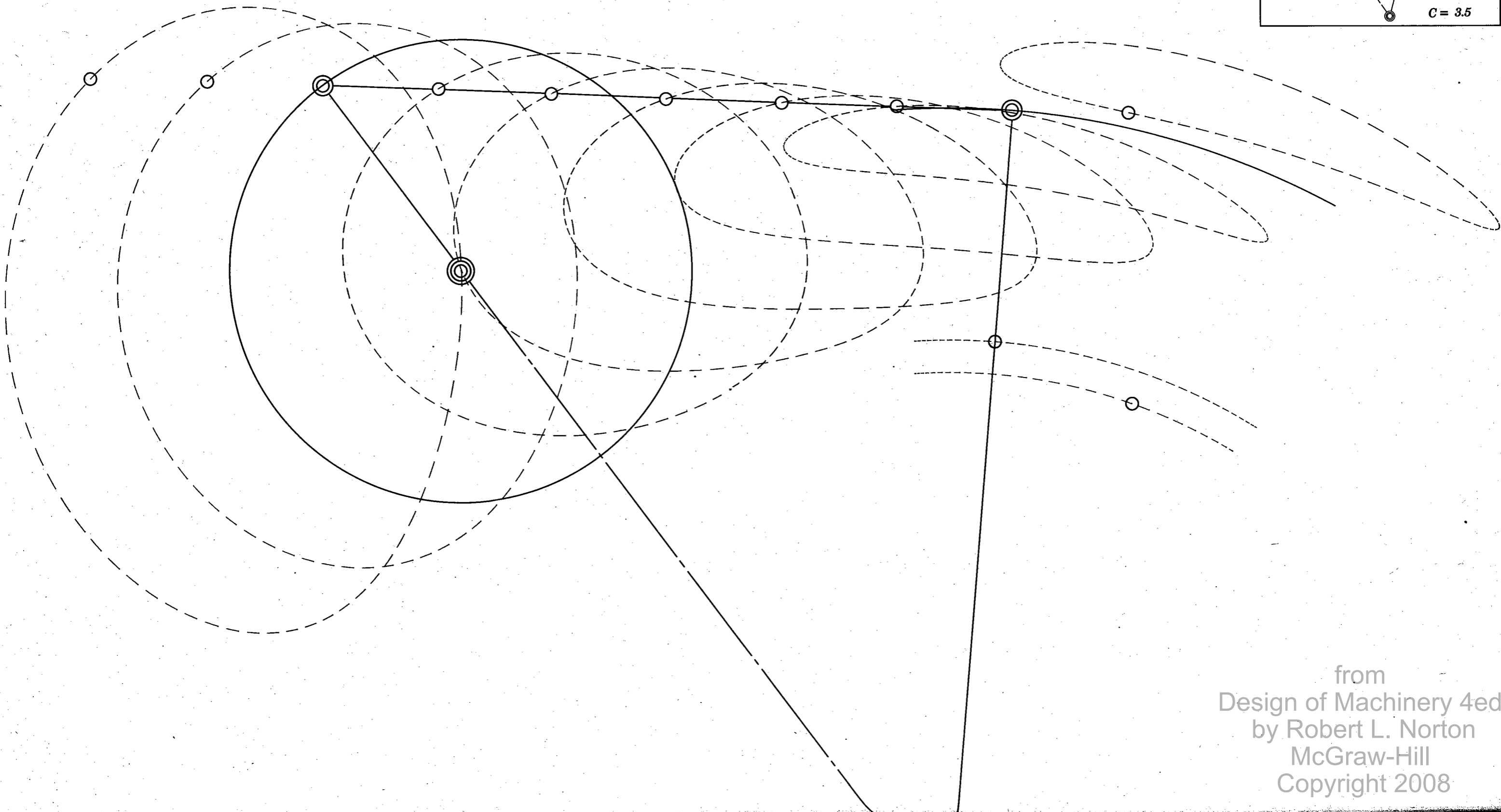
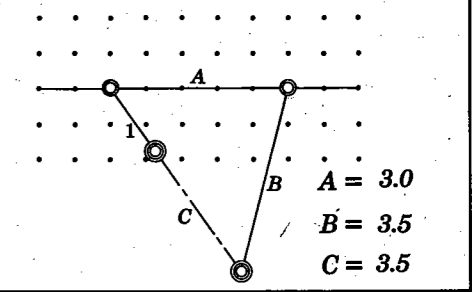

from  
Design of Machinery 4ed  
by Robert L. Norton  
McGraw-Hill  
Copyright 2008

**Analysis of the Four Bar Linkage**  
*J. A. Hrones and G. L. Nelson*

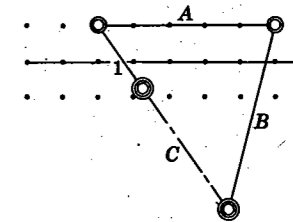

$A = 3.0$   
 $B = 3.5$   
 $C = 3.5$

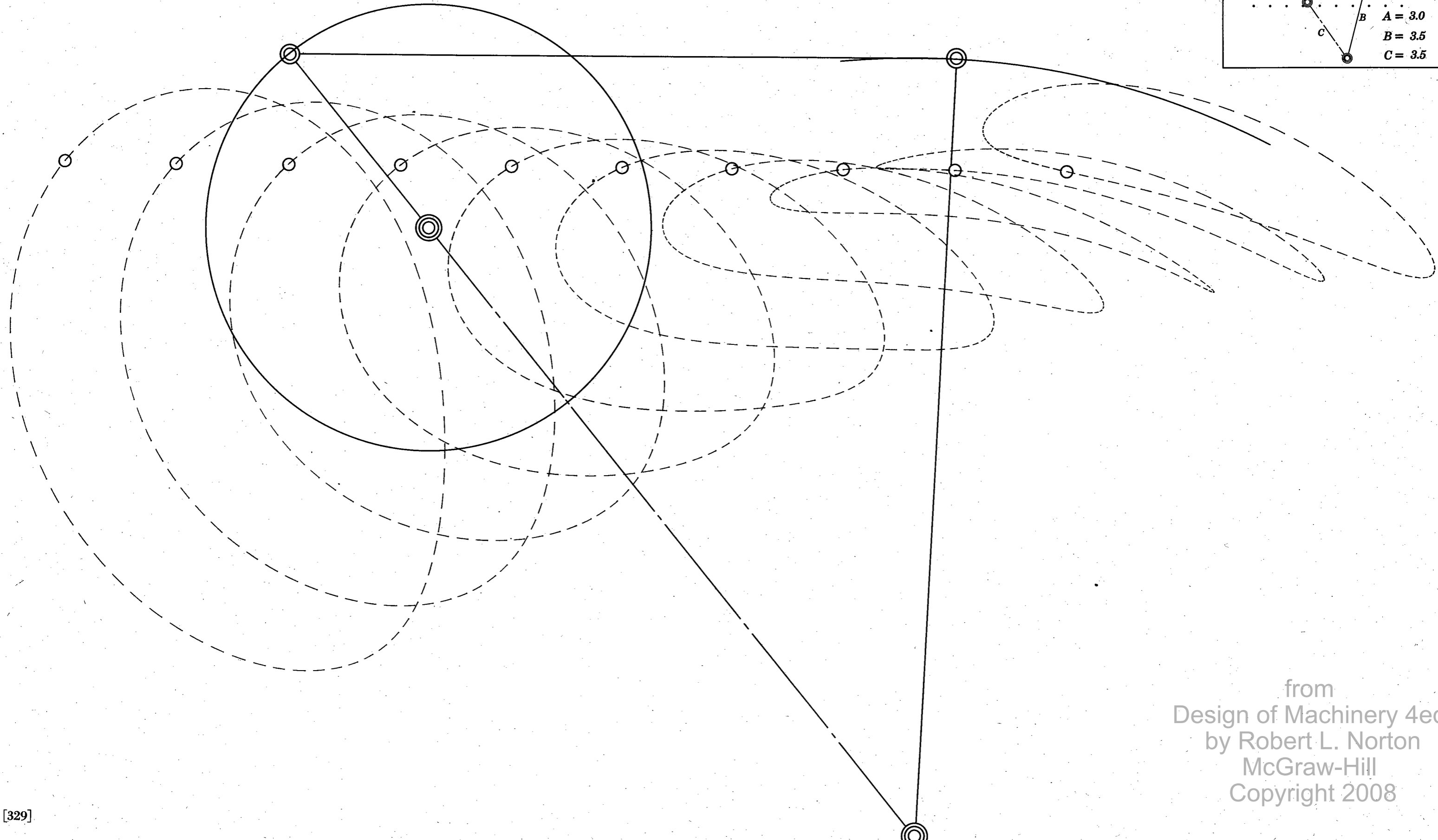

from  
 Design of Machinery 4ed  
 by Robert L. Norton  
 McGraw-Hill  
 Copyright 2008



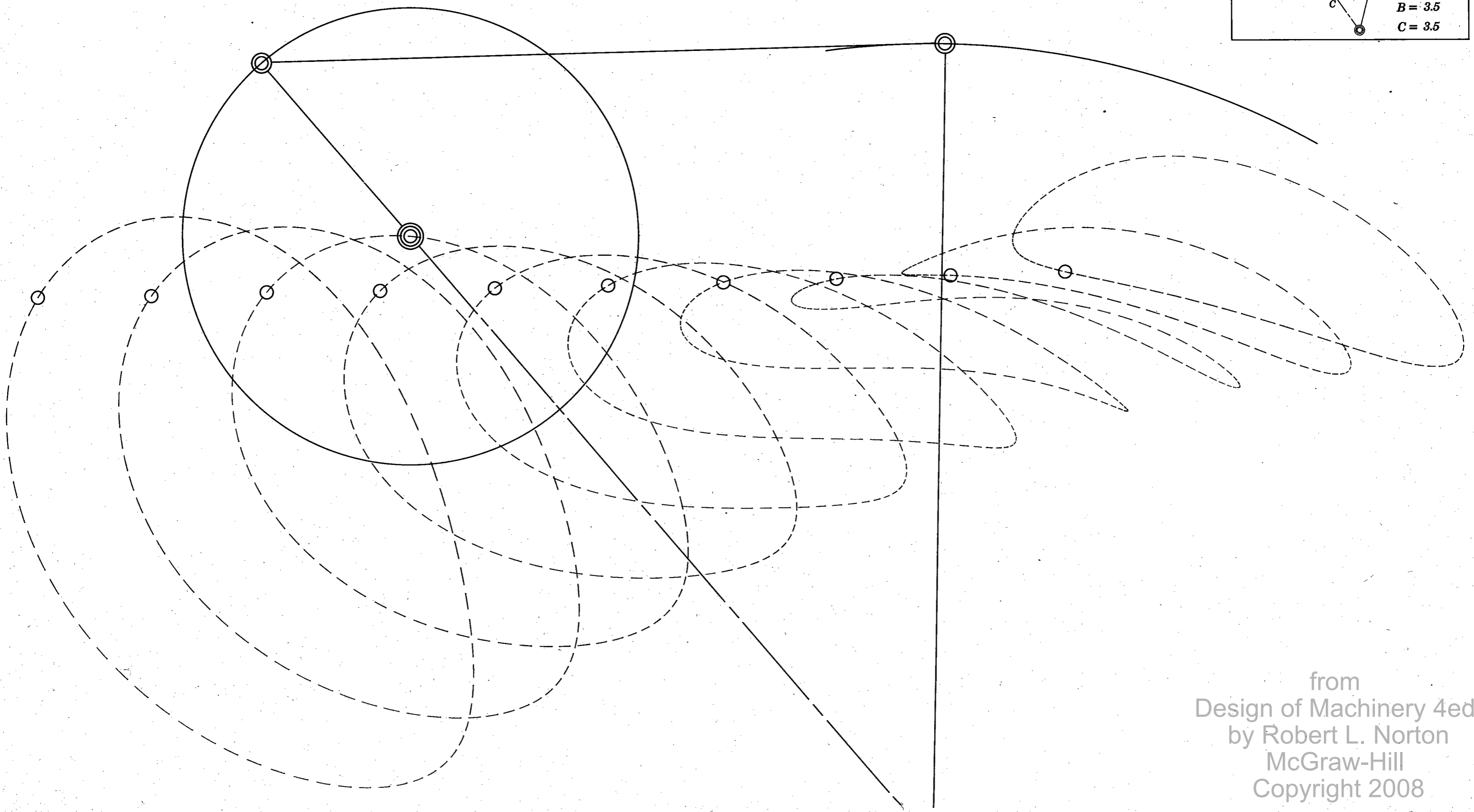
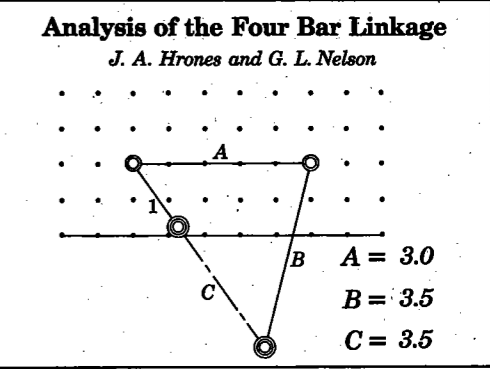

from  
Design of Machinery 4ed  
by Robert L. Norton  
McGraw-Hill  
Copyright 2008

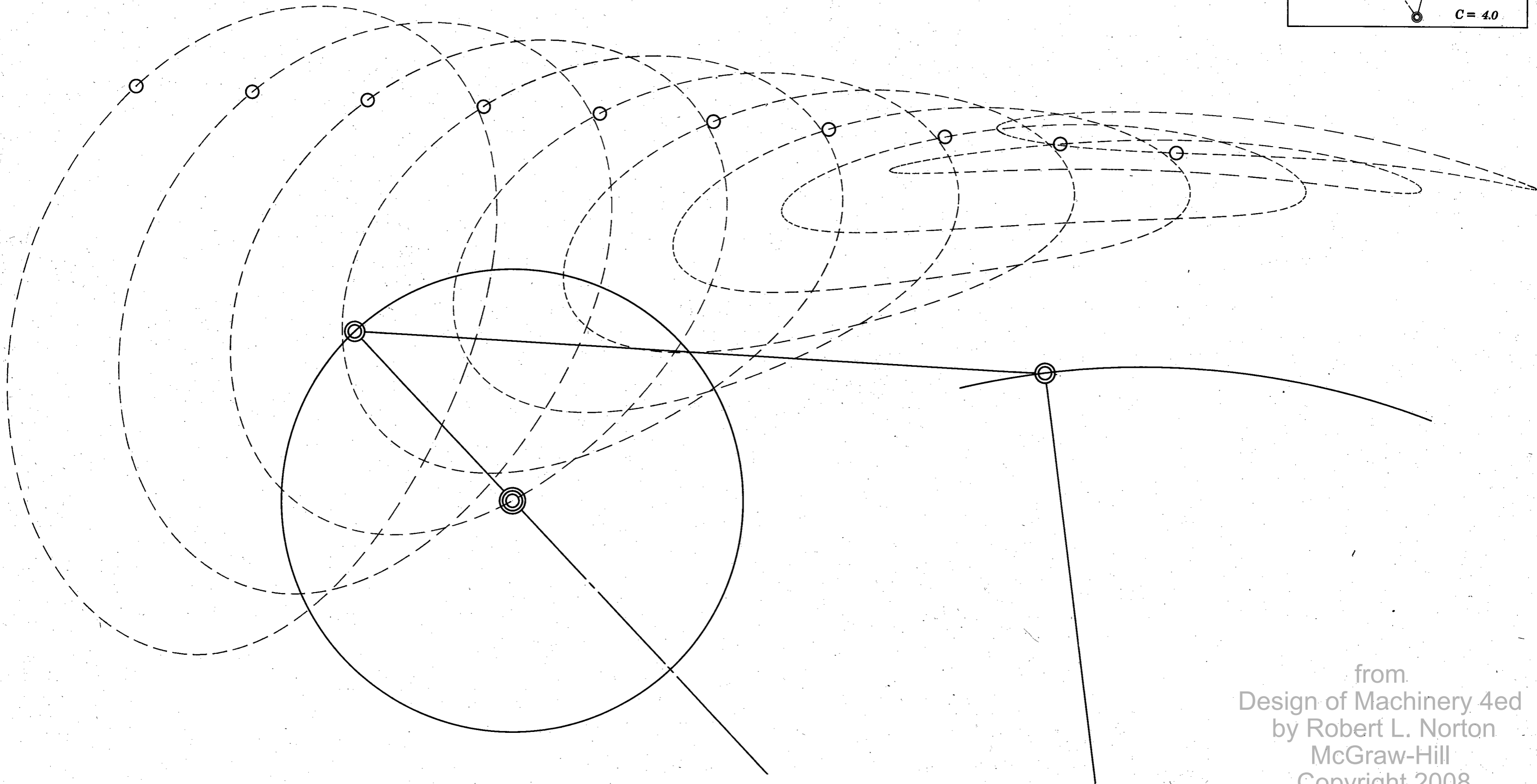
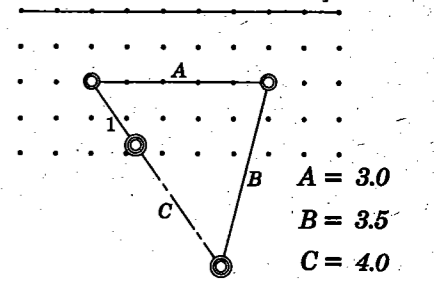

from  
Design of Machinery 4ed  
by Robert L. Norton  
McGraw-Hill  
Copyright 2008

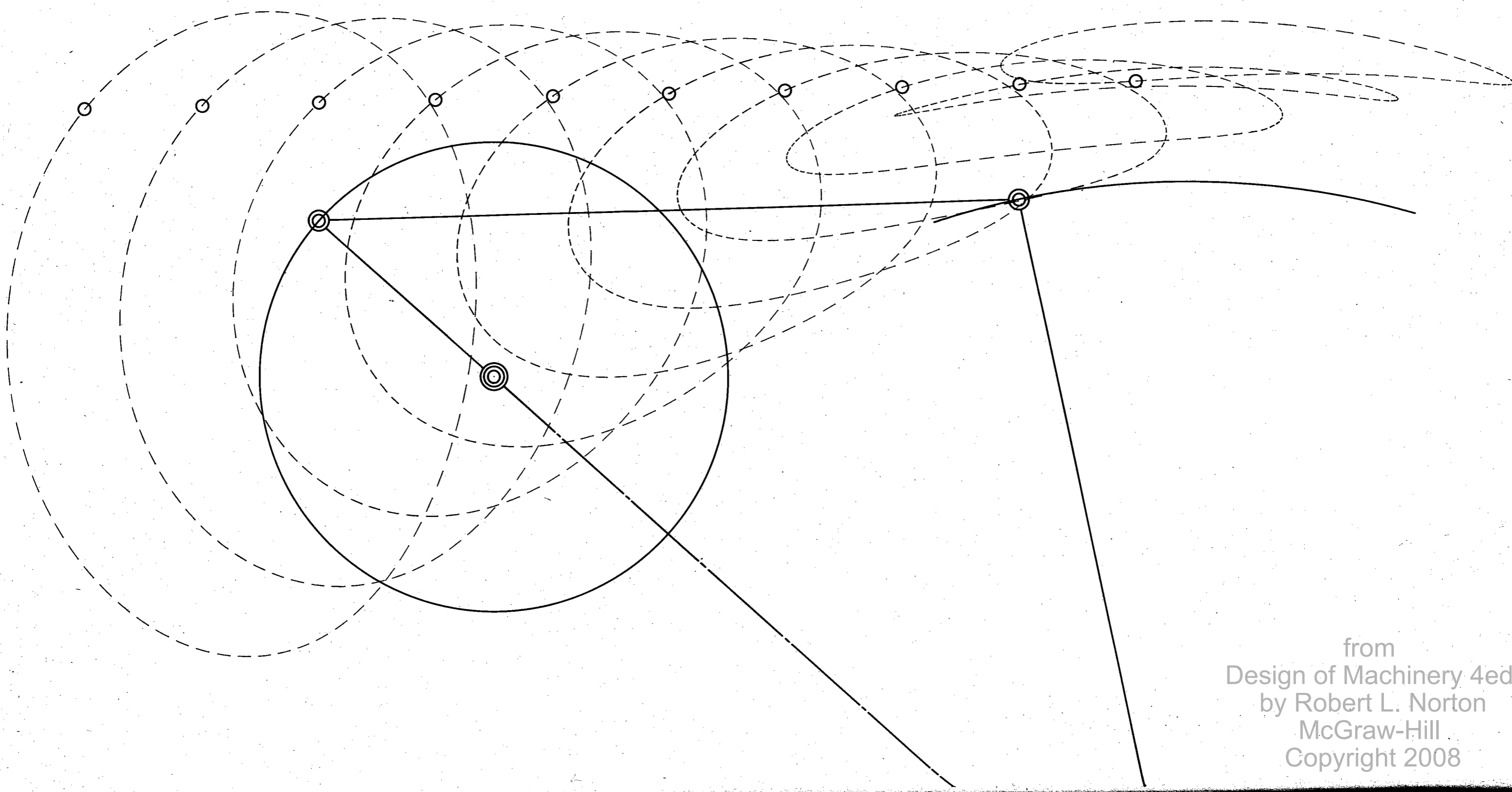
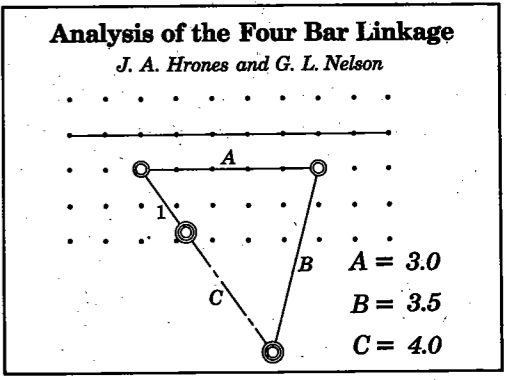

from  
Design of Machinery 4ed  
by Robert L. Norton  
McGraw-Hill  
Copyright 2008

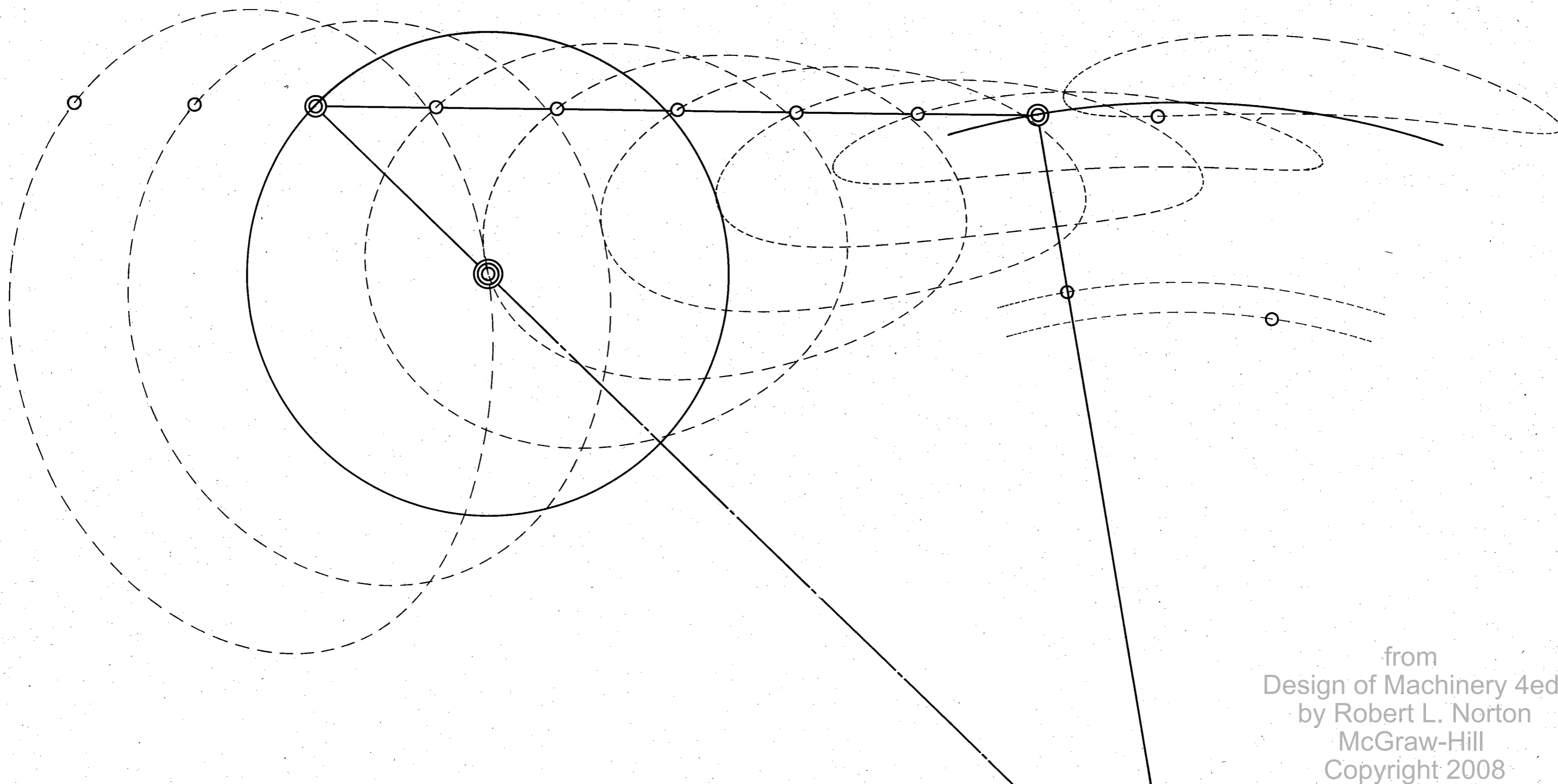
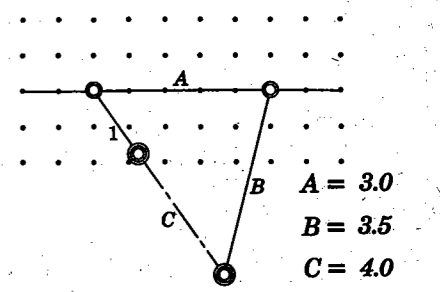

from  
Design of Machinery 4ed  
by Robert L. Norton  
McGraw-Hill  
Copyright 2008

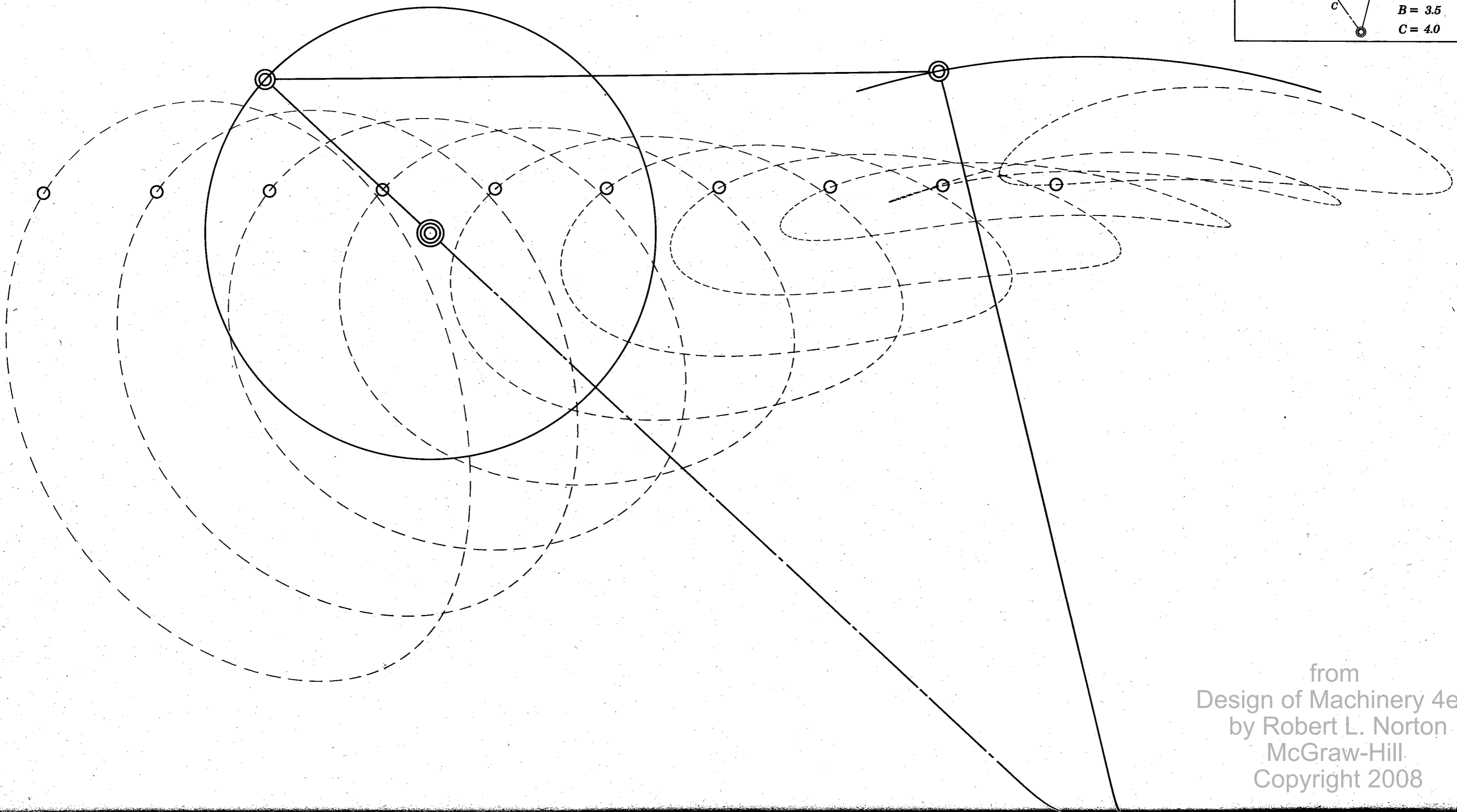
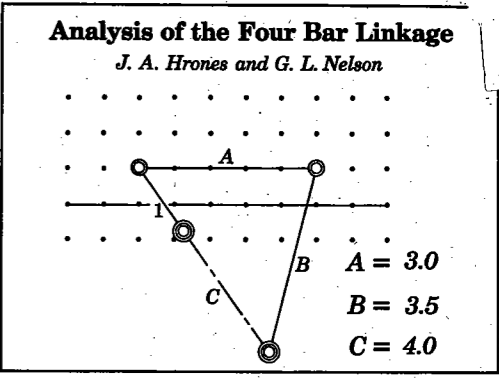

from  
Design of Machinery 4ed  
by Robert L. Norton  
McGraw-Hill  
Copyright 2008

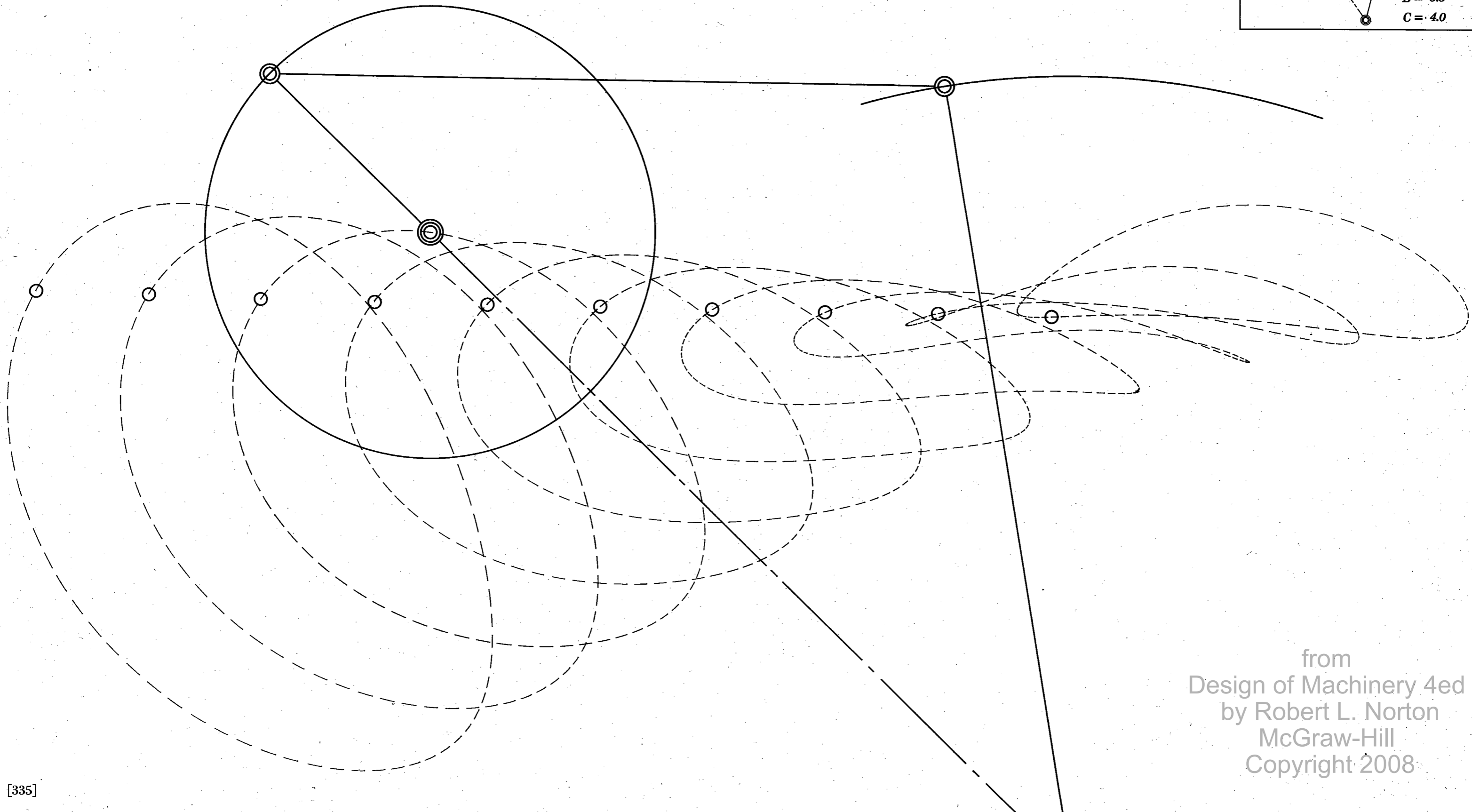
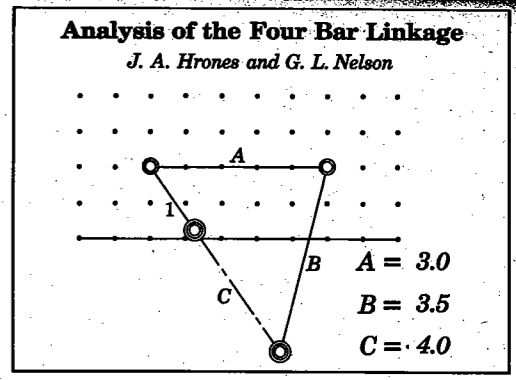

from  
 Design of Machinery 4ed  
 by Robert L. Norton  
 McGraw-Hill  
 Copyright 2008

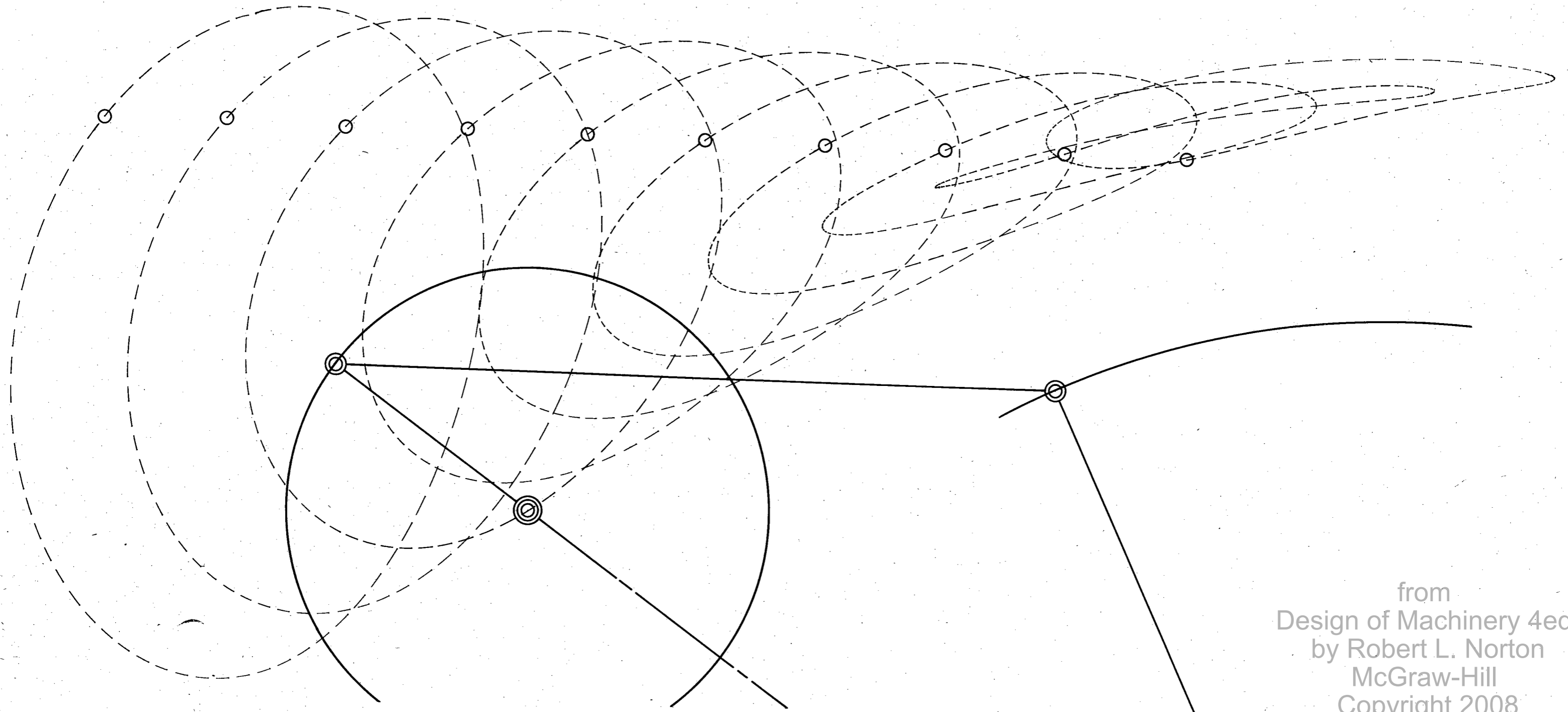
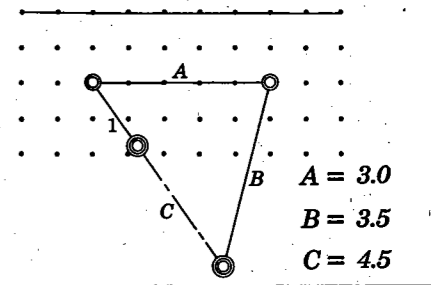

from  
Design of Machinery 4ed  
by Robert L. Norton  
McGraw-Hill  
Copyright 2008

**Analysis of the Four Bar Linkage**  
*J. A. Hrones and G. L. Nelson*

$A = 3.0$   
 $B = 3.5$   
 $C = 4.5$

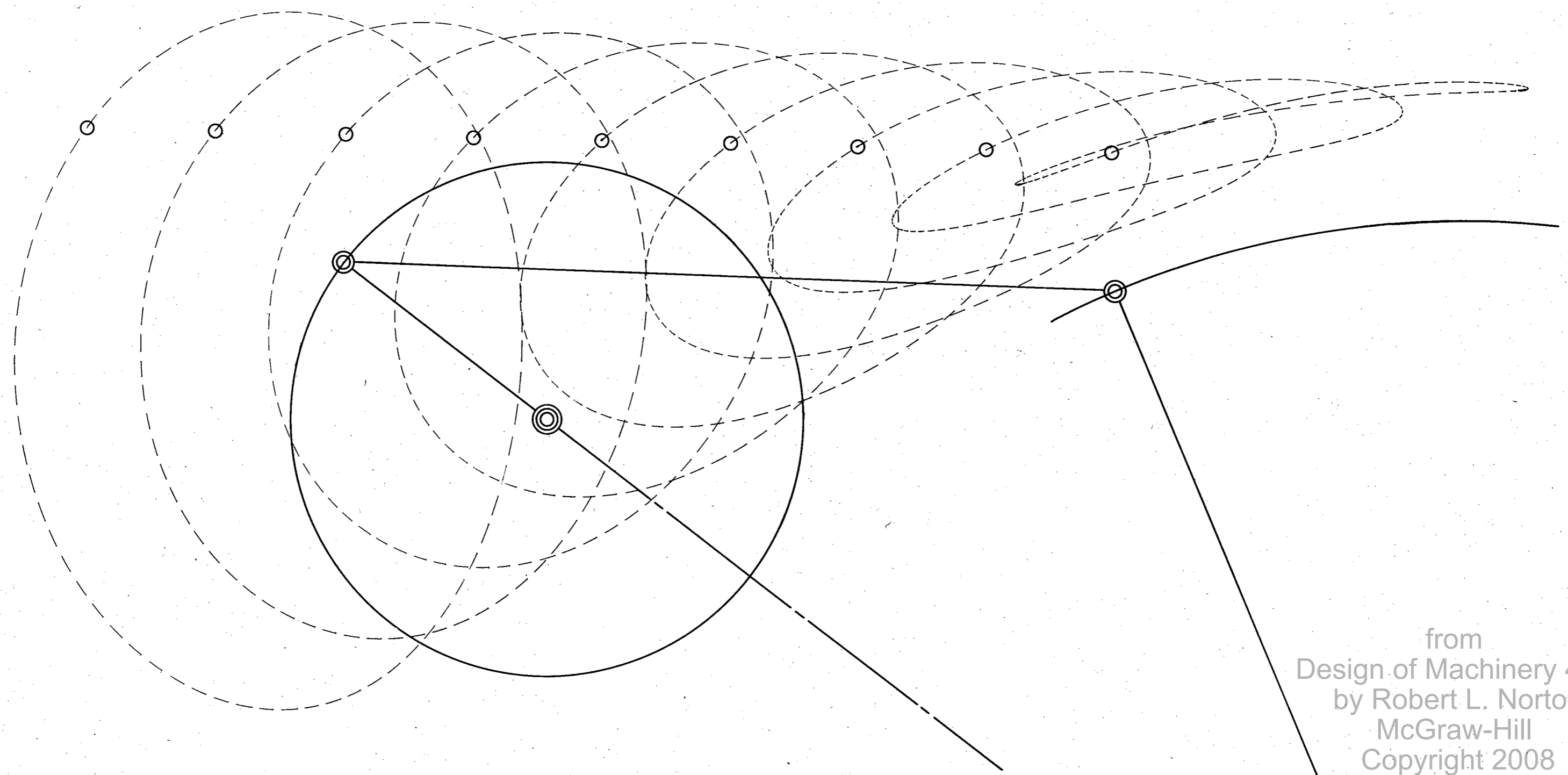

from  
 Design of Machinery 4ed  
 by Robert L. Norton  
 McGraw-Hill  
 Copyright 2008



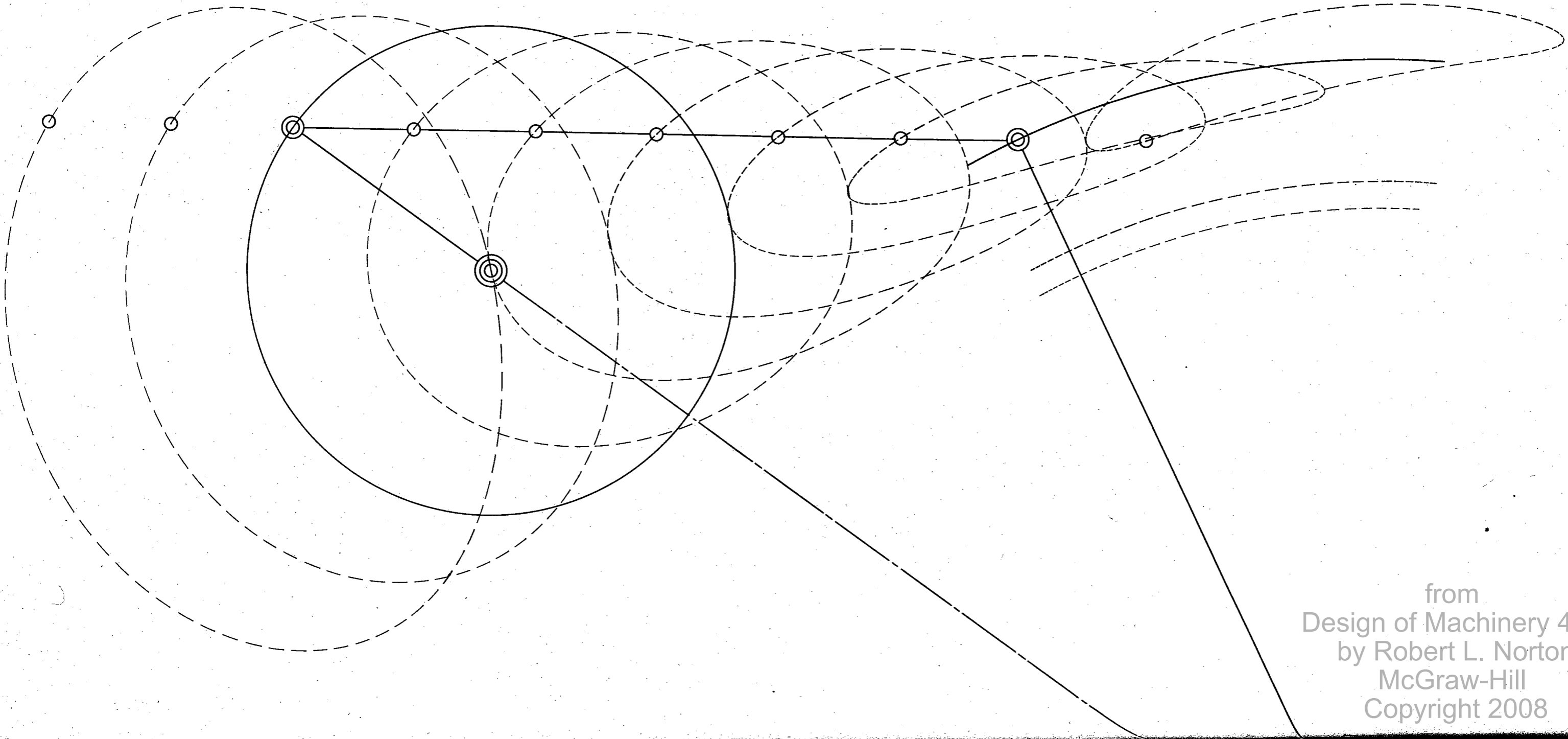
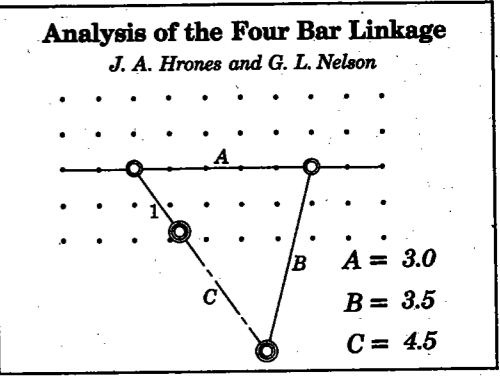

from  
Design of Machinery 4ed  
by Robert L. Norton  
McGraw-Hill  
Copyright 2008

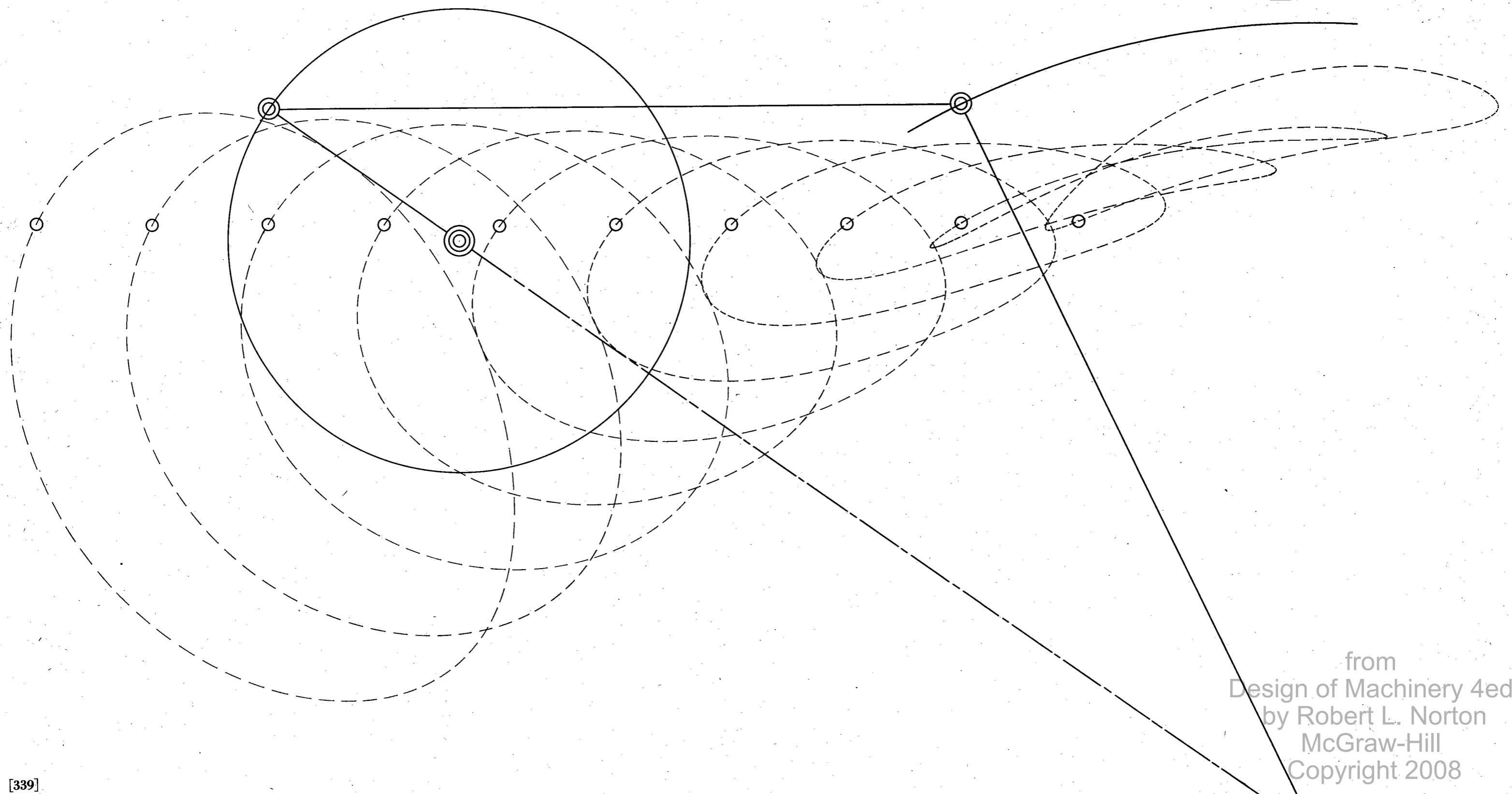
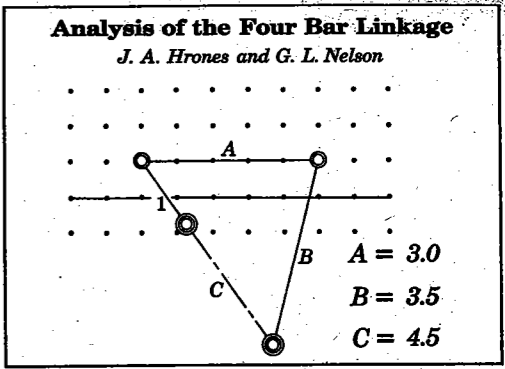

from  
 Design of Machinery 4ed  
 by Robert L. Norton  
 McGraw-Hill  
 Copyright 2008

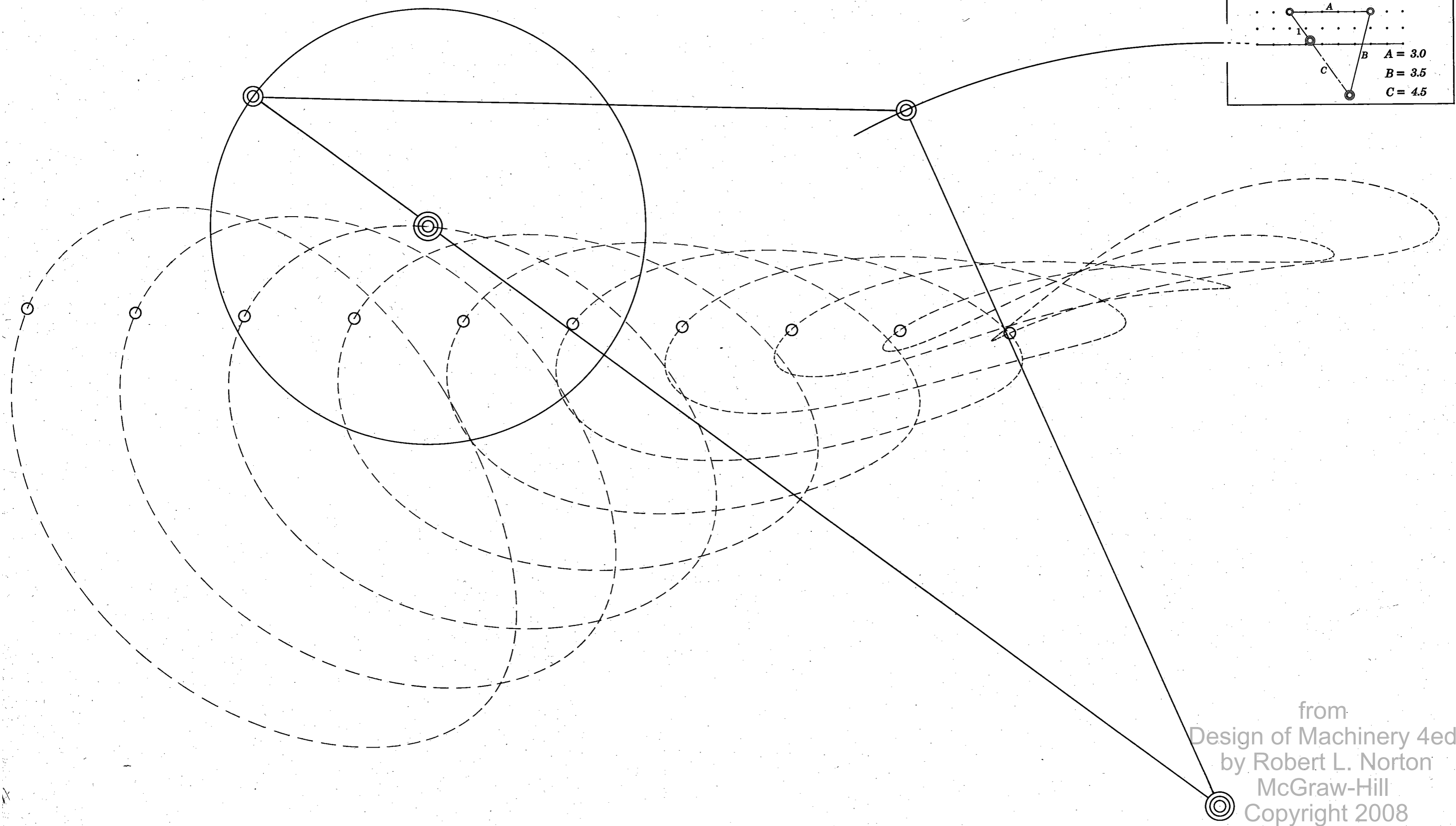
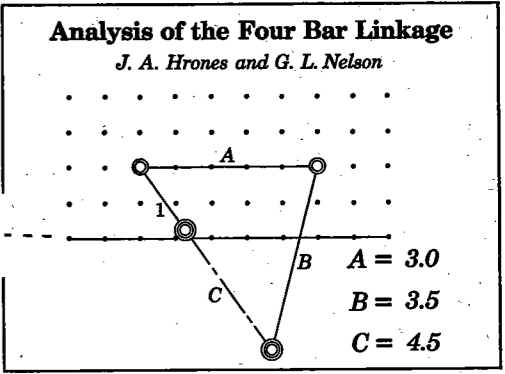

from  
Design of Machinery 4ed  
by Robert L. Norton  
McGraw-Hill  
Copyright 2008

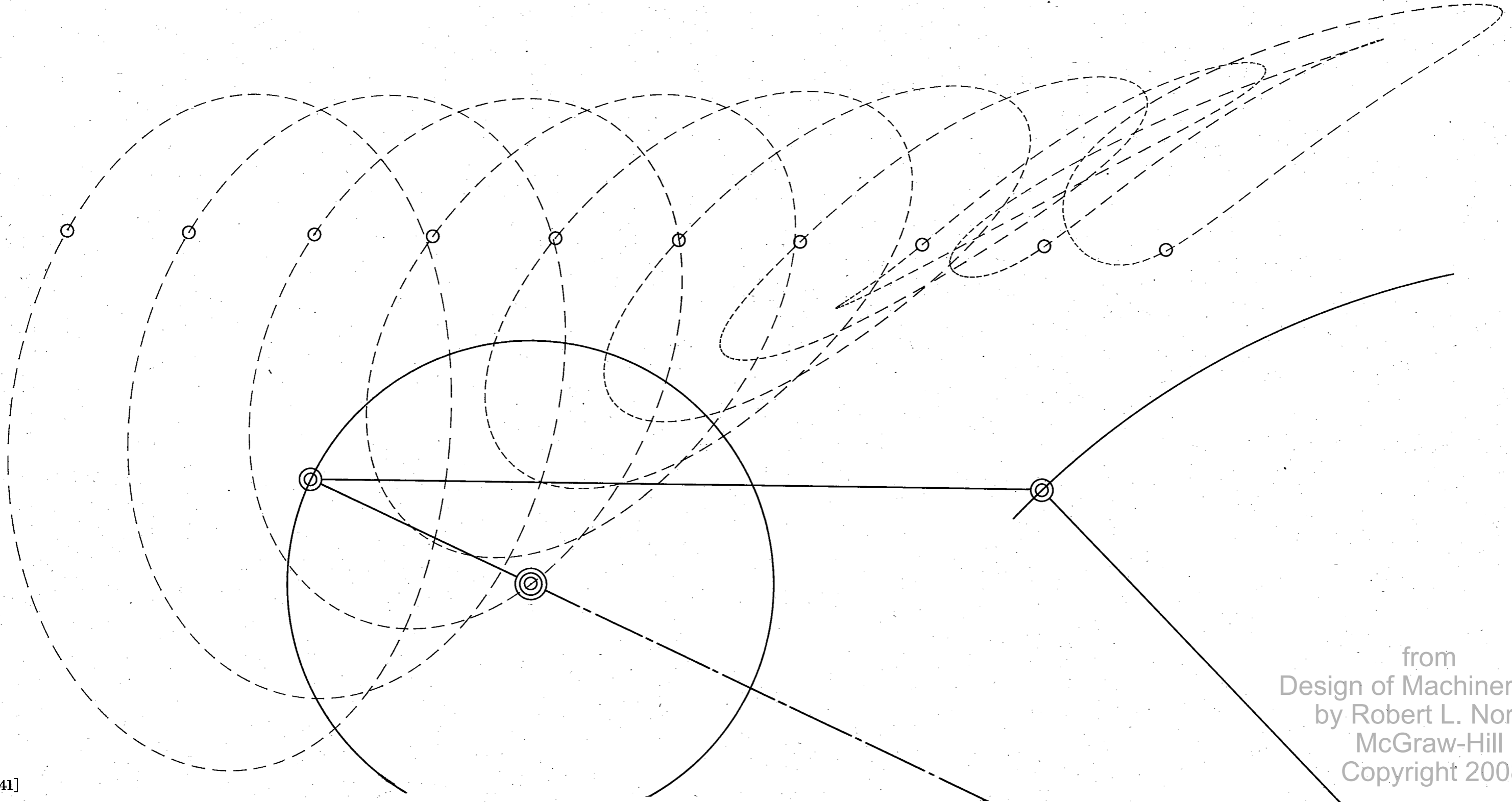
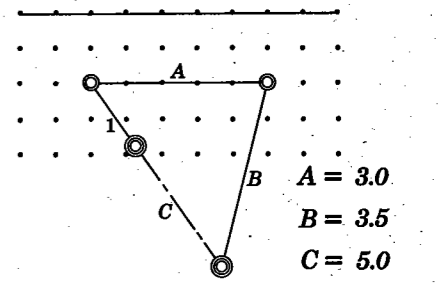

from  
Design of Machinery 4ed  
by Robert L. Norton  
McGraw-Hill  
Copyright 2008

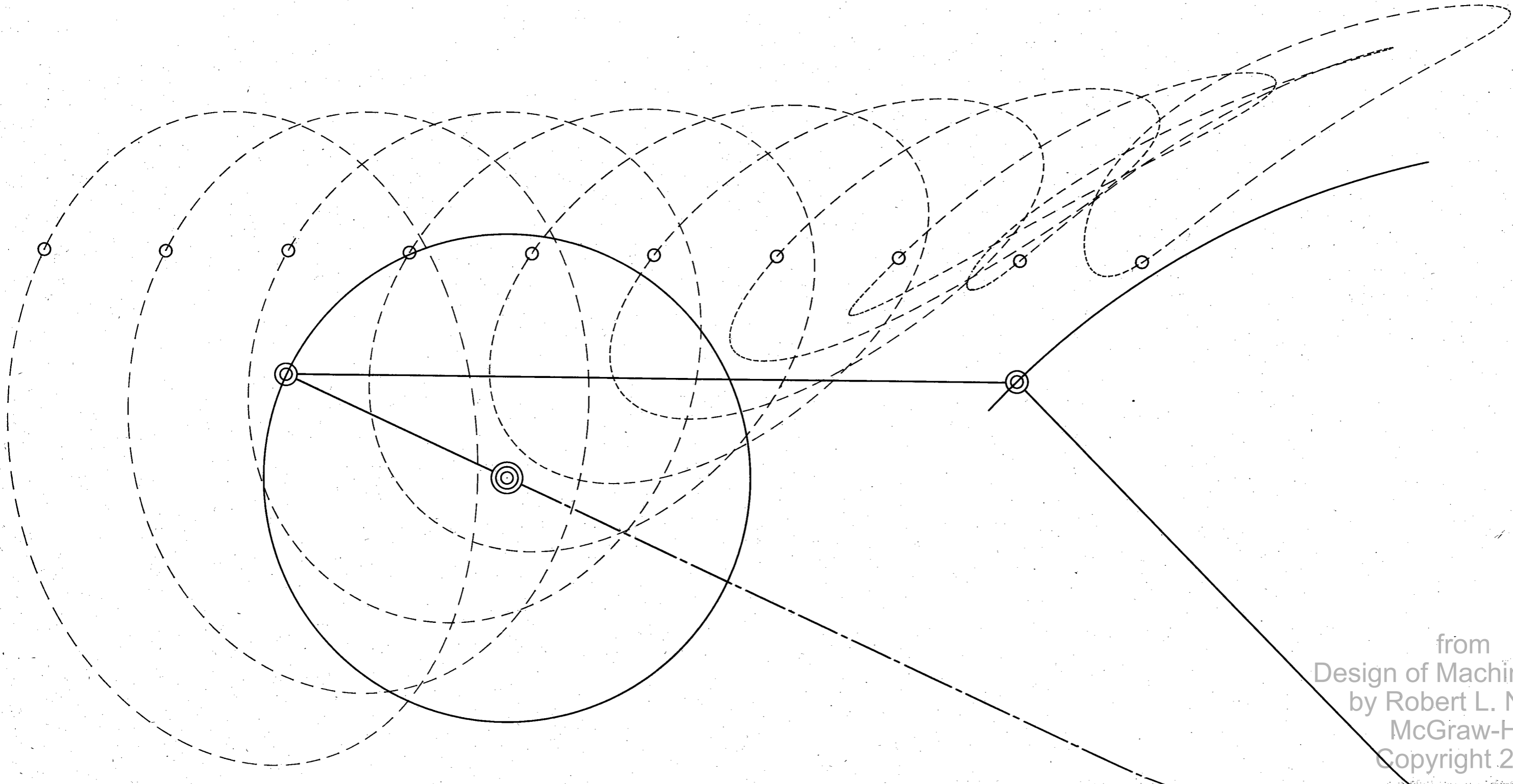
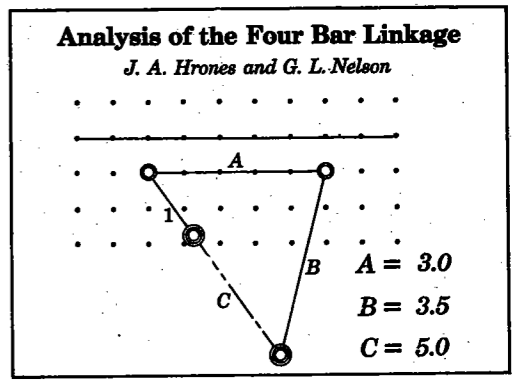

from  
Design of Machinery 4ed  
by Robert L. Norton  
McGraw-Hill  
Copyright 2008

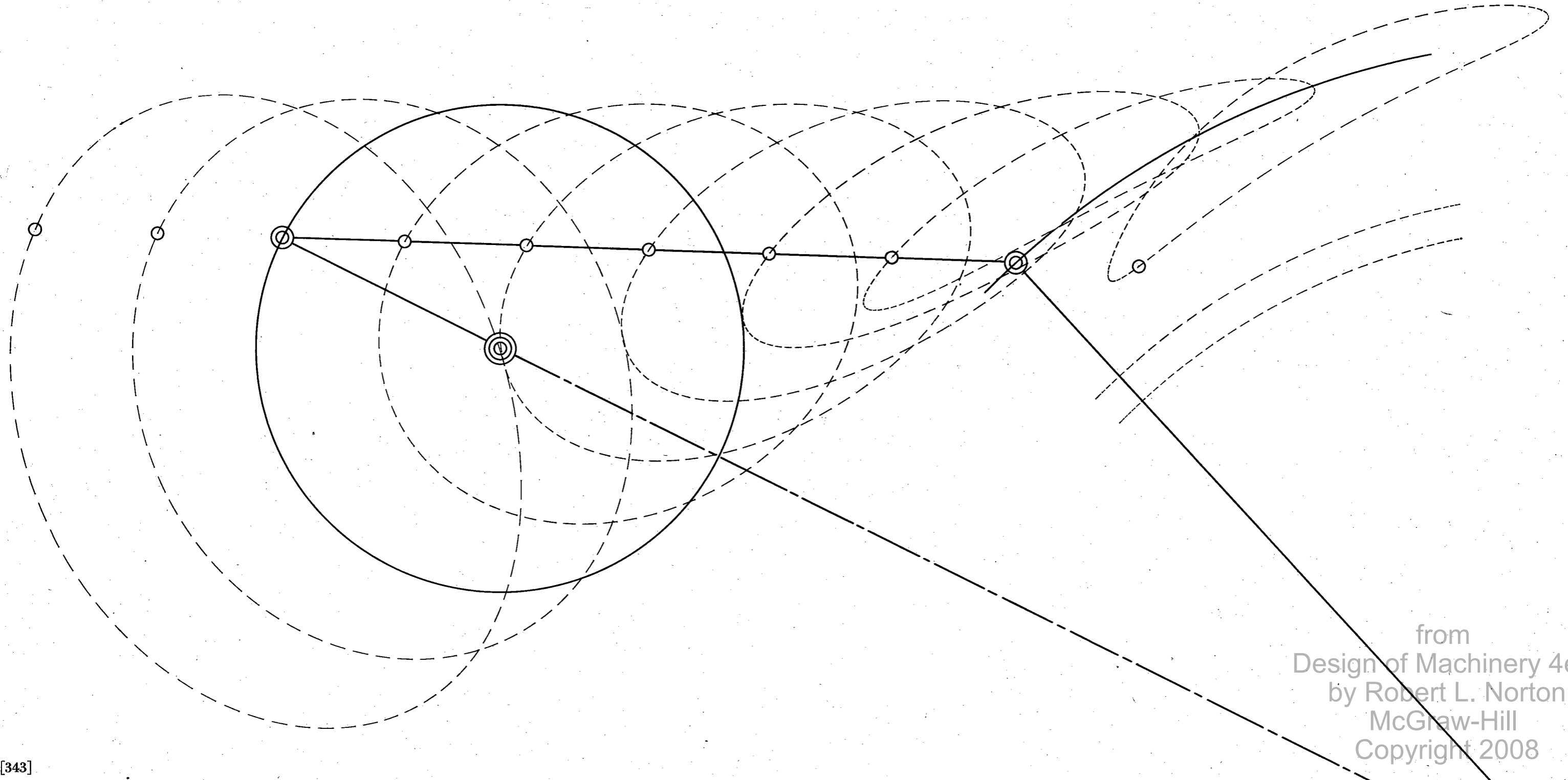
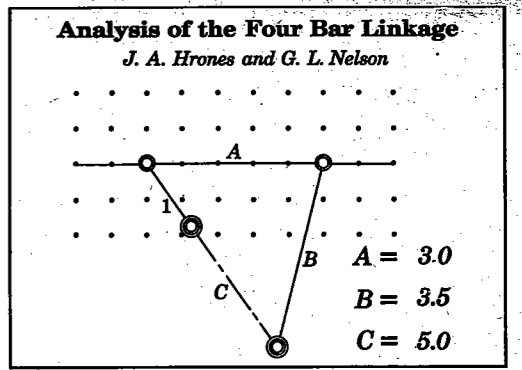

from  
 Design of Machinery 4ed  
 by Robert L. Norton  
 McGraw-Hill  
 Copyright 2008

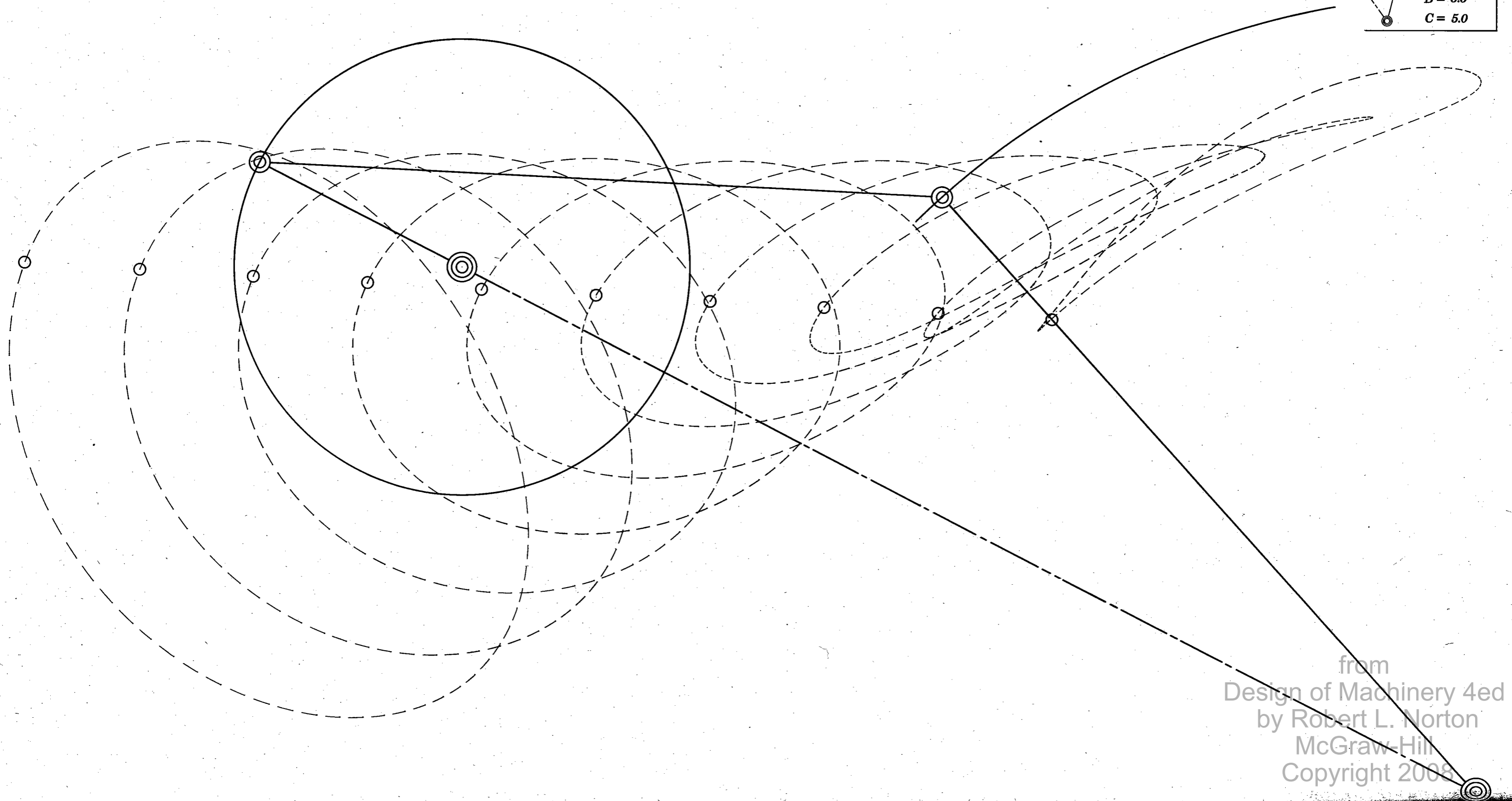
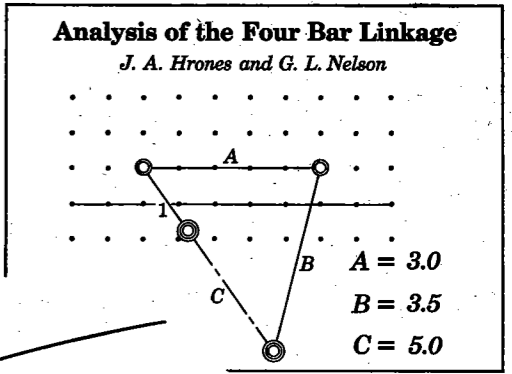

from  
Design of Machinery 4ed  
by Robert L. Norton  
McGraw-Hill  
Copyright 2008

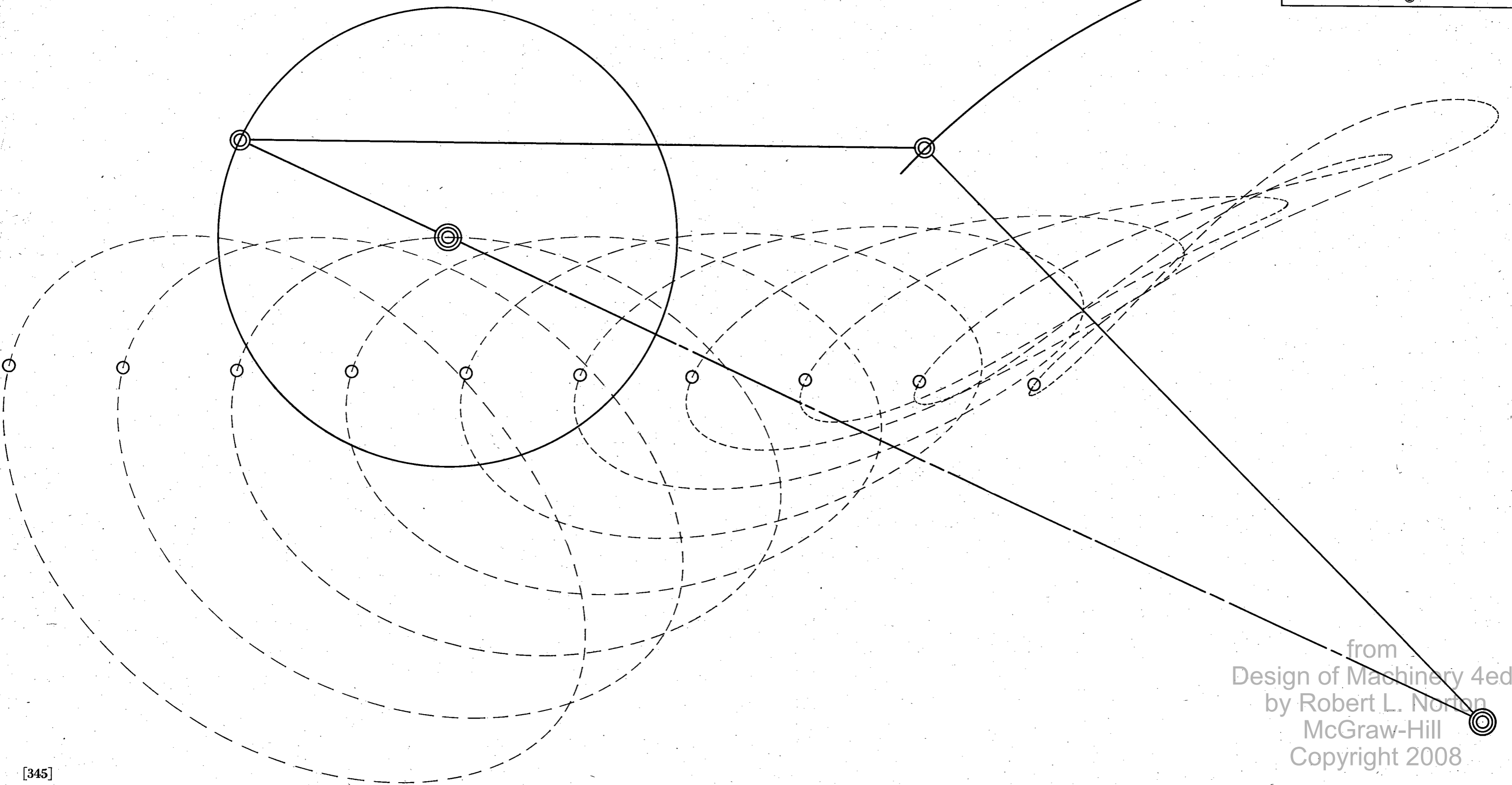
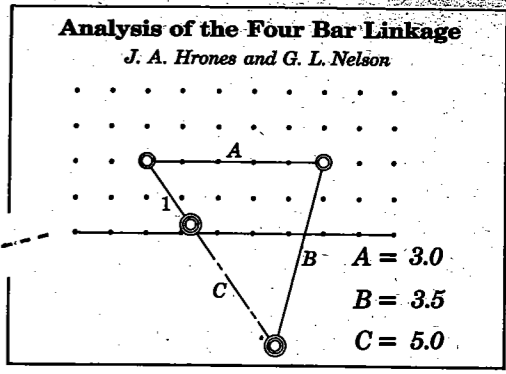

from  
 Design of Machinery 4ed  
 by Robert L. Norton  
 McGraw-Hill  
 Copyright 2008



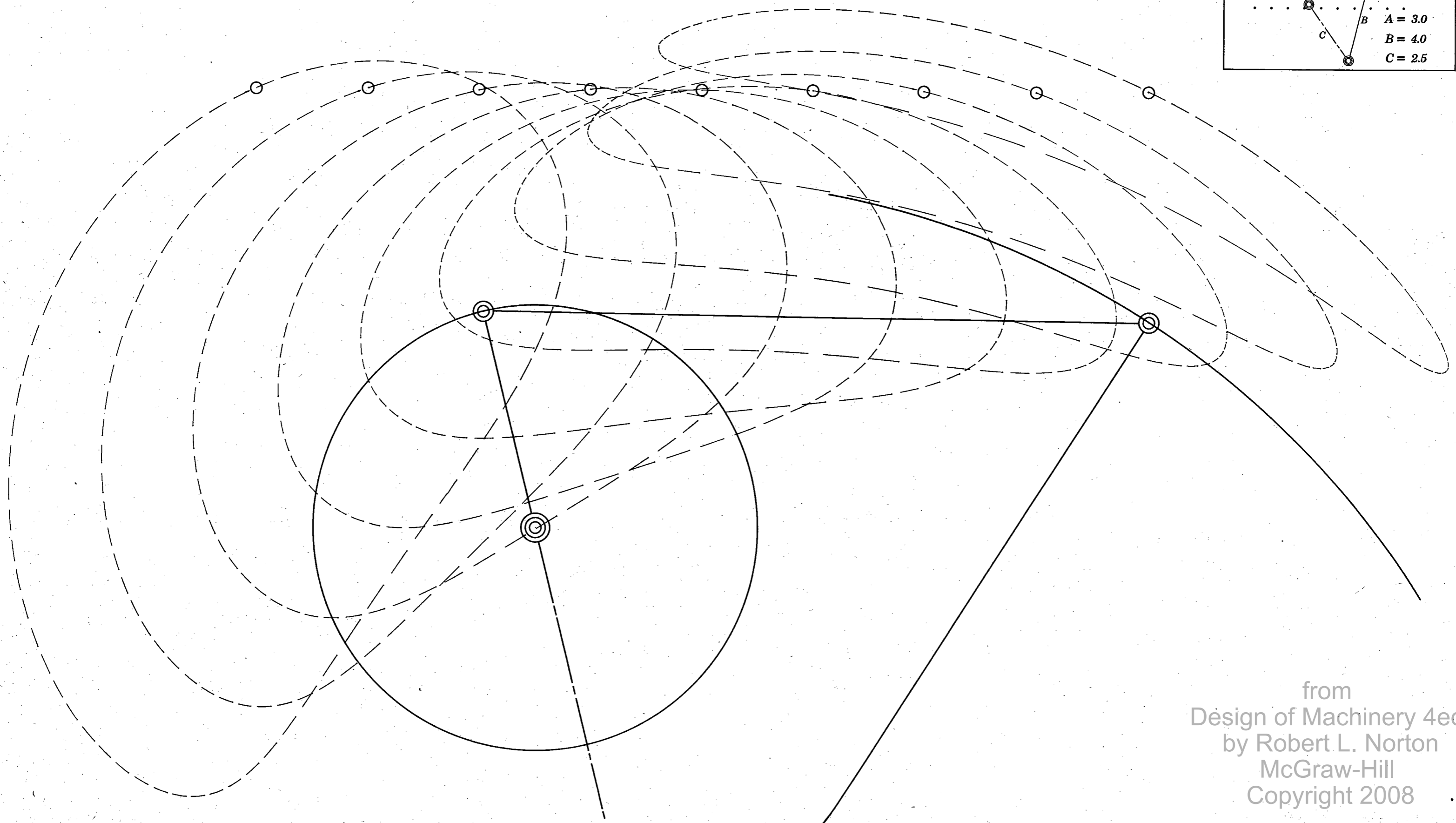
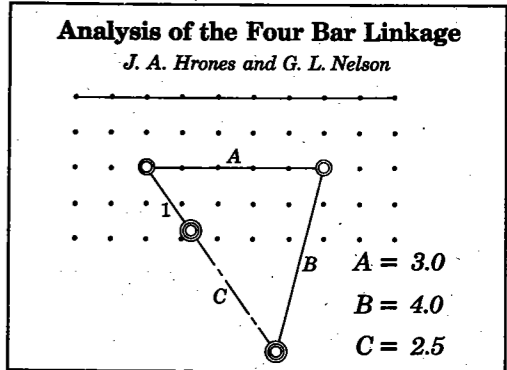

from  
Design of Machinery 4ed  
by Robert L. Norton  
McGraw-Hill  
Copyright 2008

**Analysis of the Four Bar Linkage**  
*J. A. Hrones and G. L. Nelson*

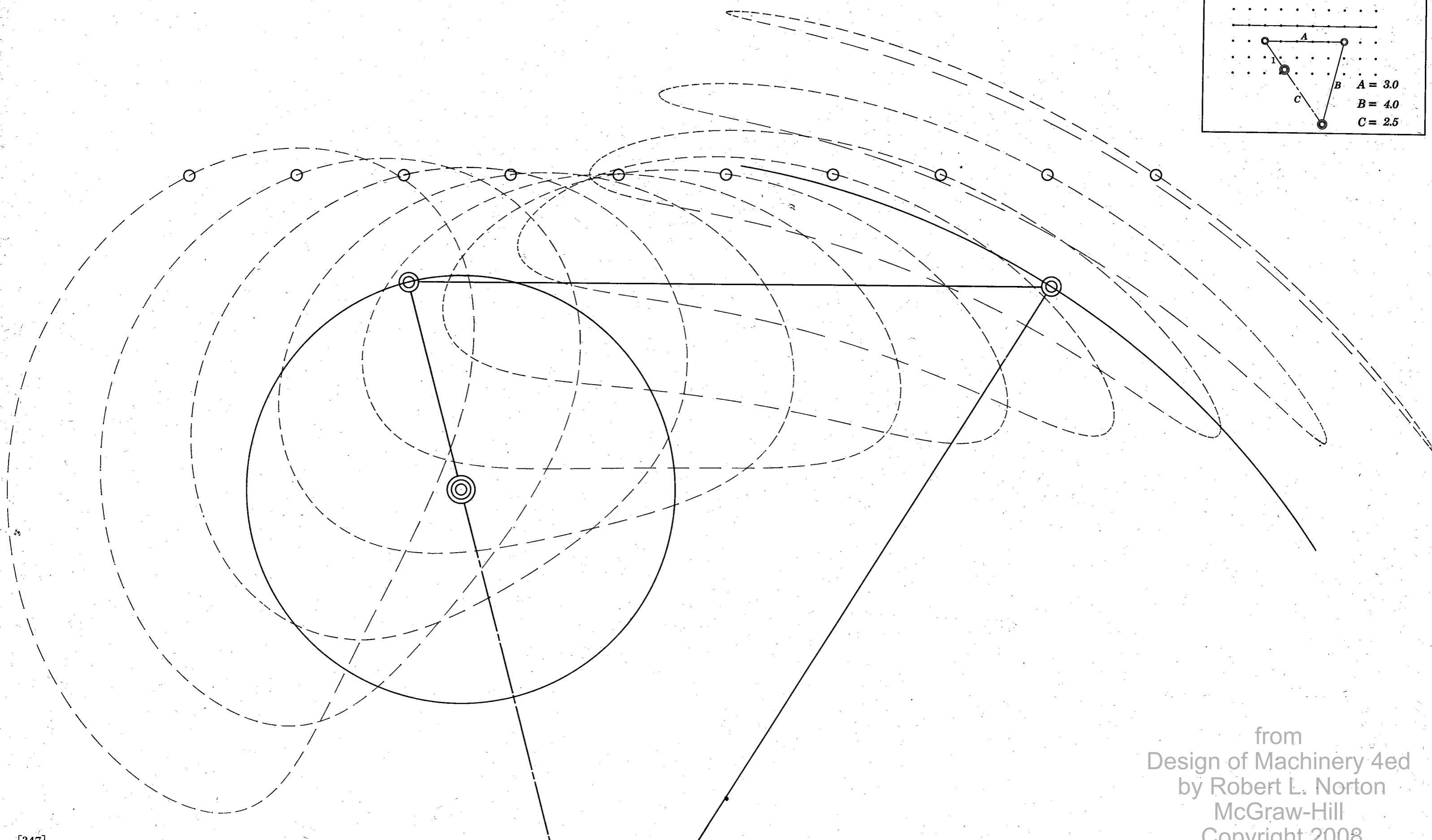
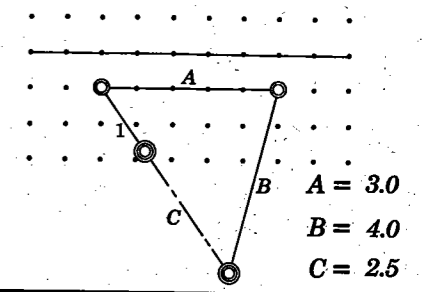

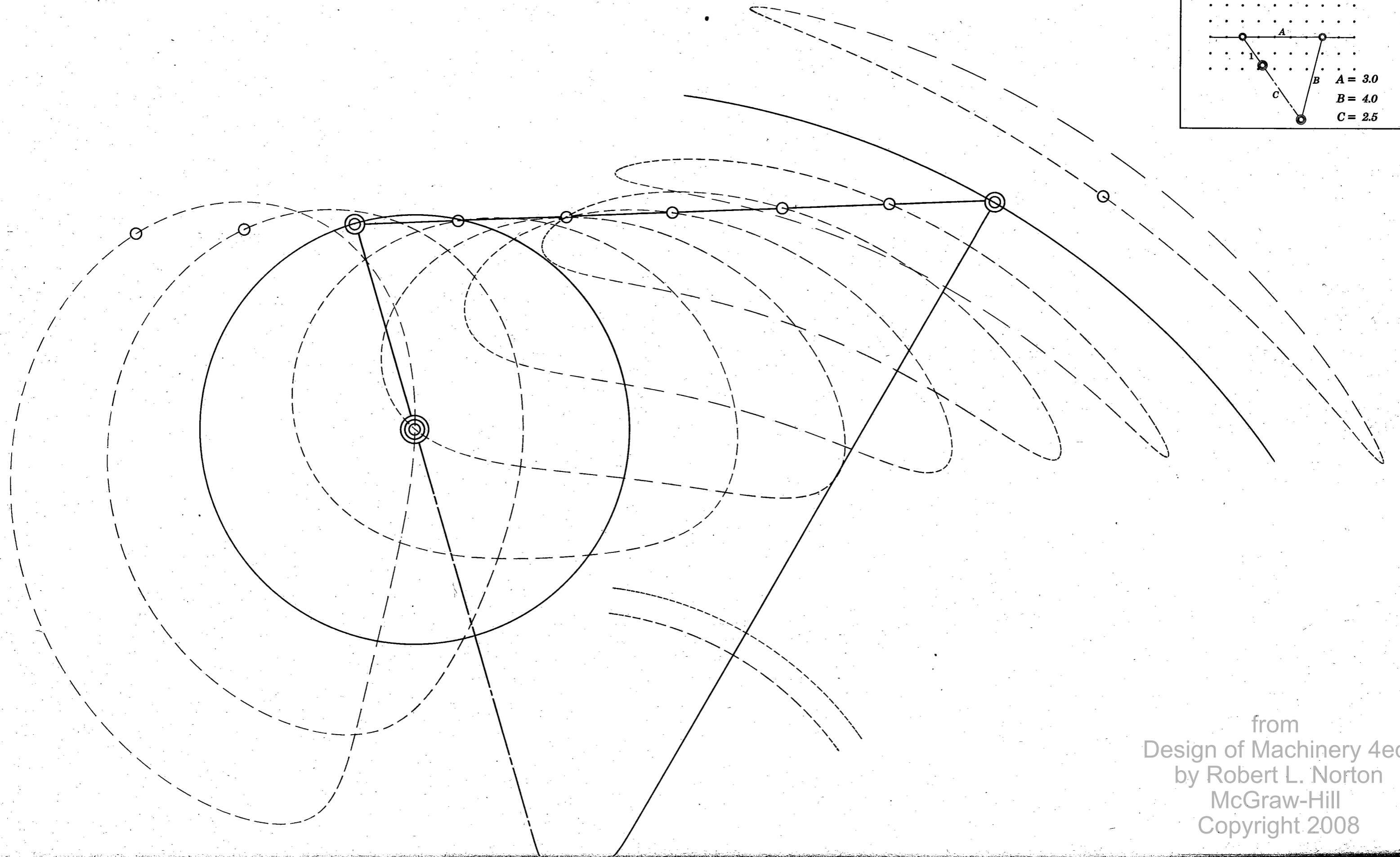
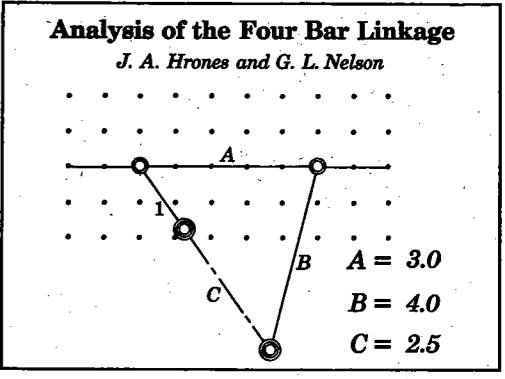

from  
Design of Machinery 4ed  
by Robert L. Norton  
McGraw-Hill  
Copyright 2008

**Analysis of the Four Bar Linkage**

*J. A. Hrones and G. L. Nelson*

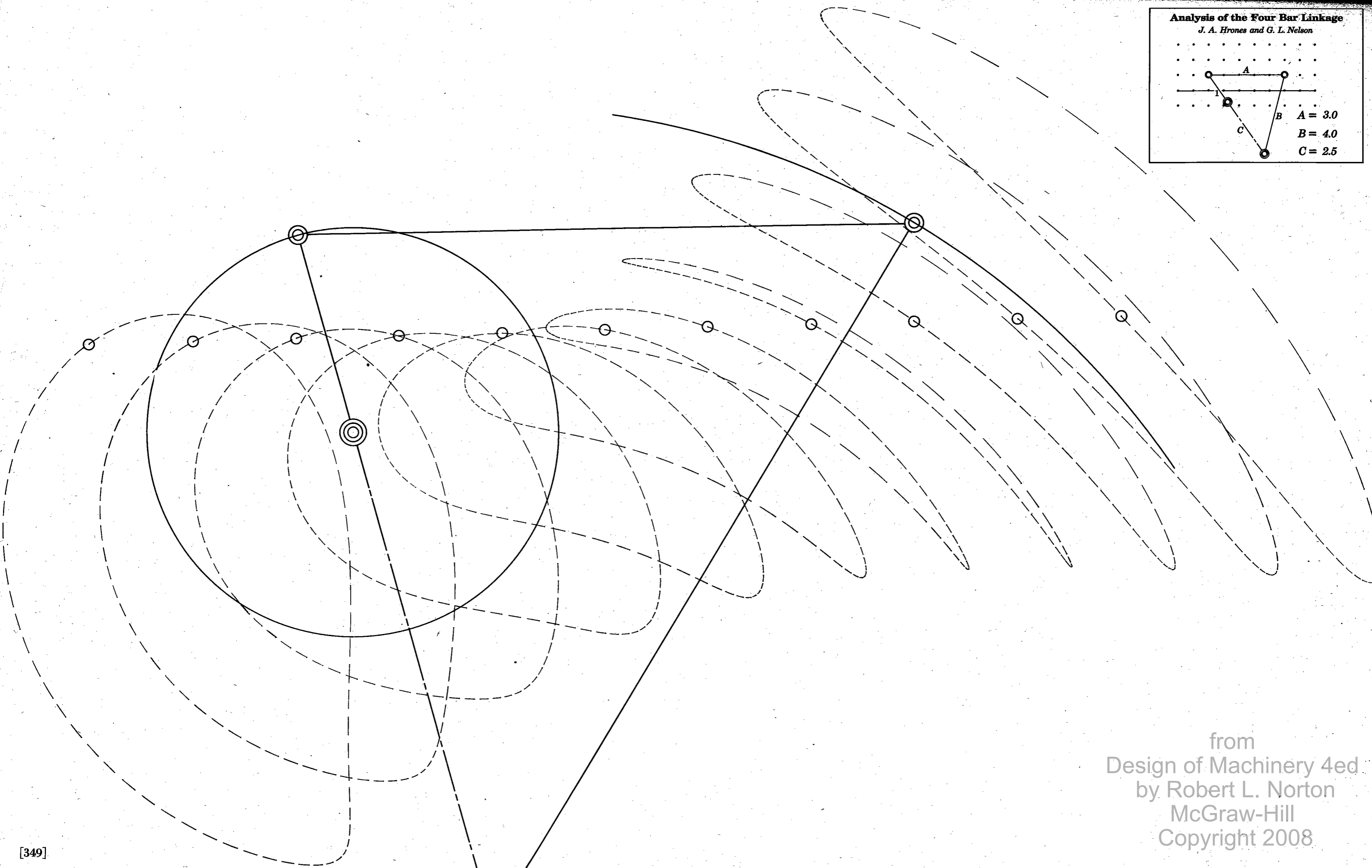
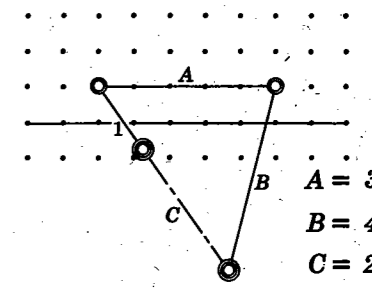

from  
Design of Machinery 4ed  
by Robert L. Norton  
McGraw-Hill  
Copyright 2008

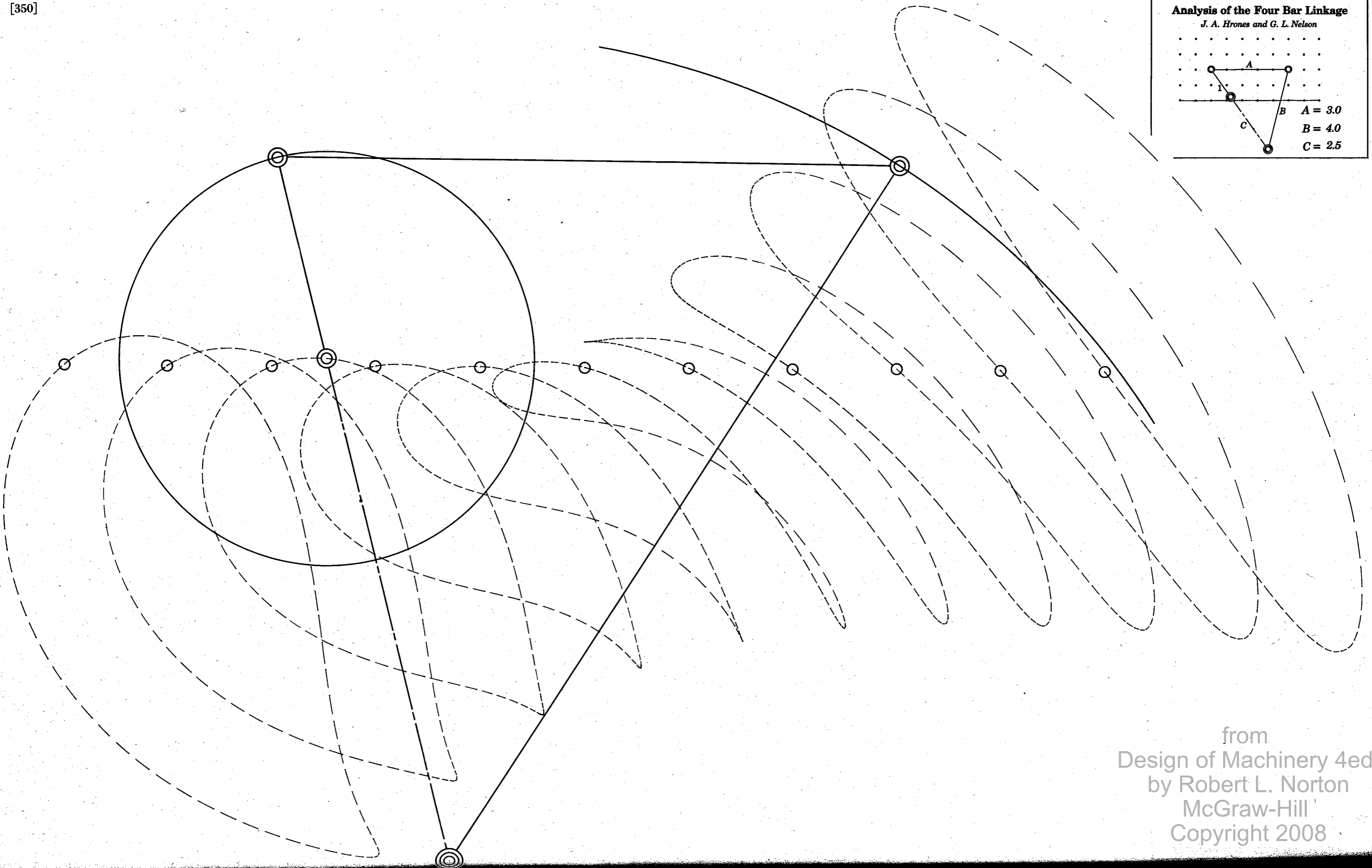
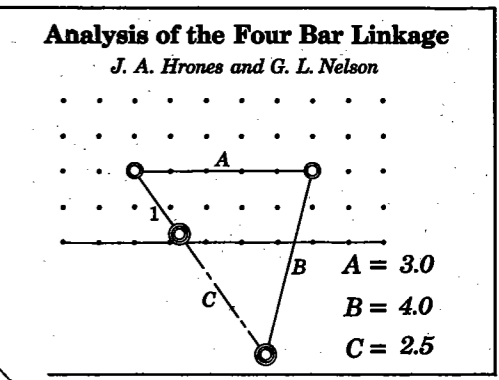

from  
Design of Machinery 4ed  
by Robert L. Norton  
McGraw-Hill  
Copyright 2008

**Analysis of the Four Bar Linkage**  
*J. A. Hrones and G. L. Nelson*

$A = 3.0$   
 $B = 4.0$   
 $C = 3.0$

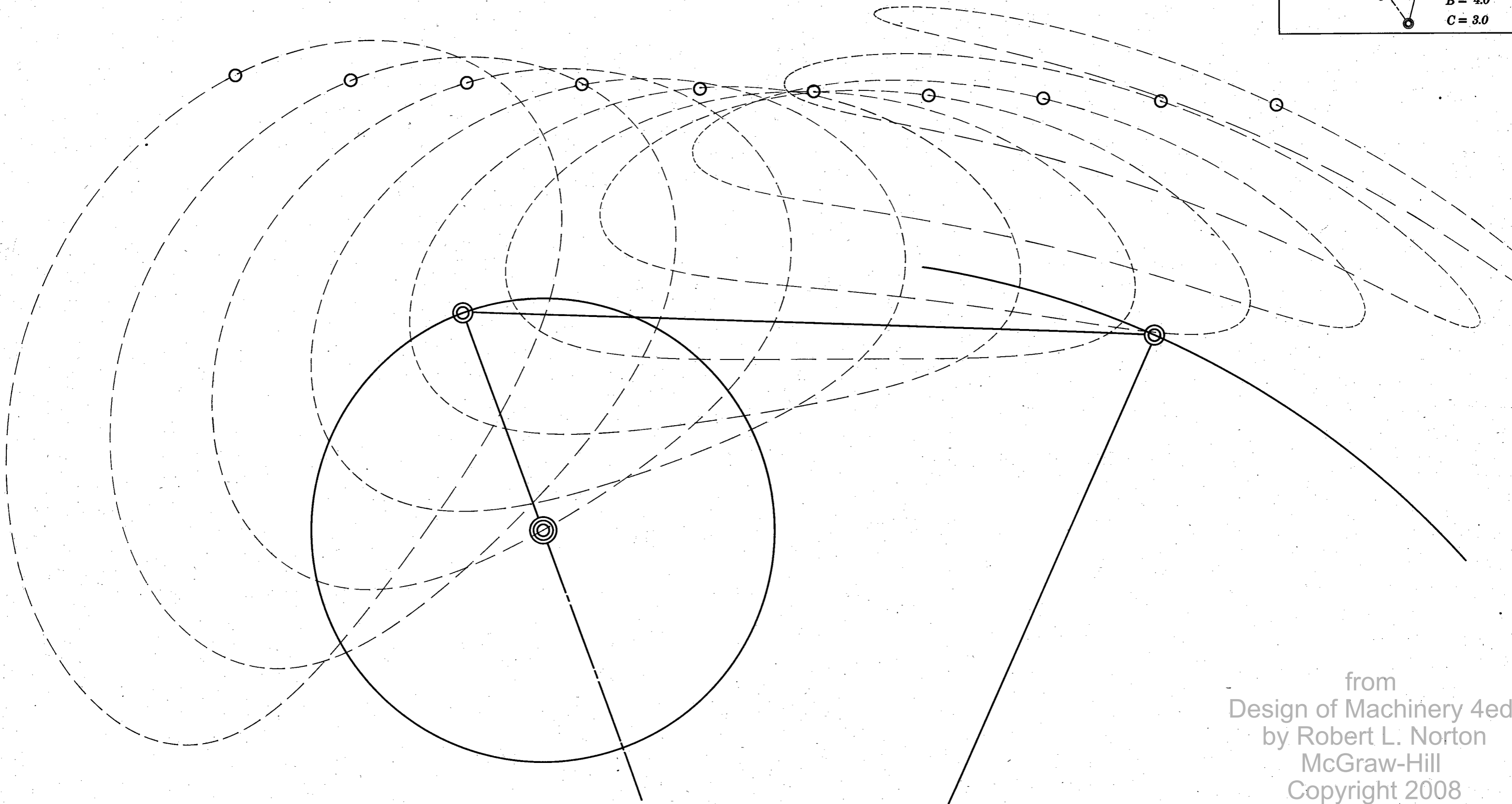

from  
 Design of Machinery 4ed  
 by Robert L. Norton  
 McGraw-Hill  
 Copyright 2008

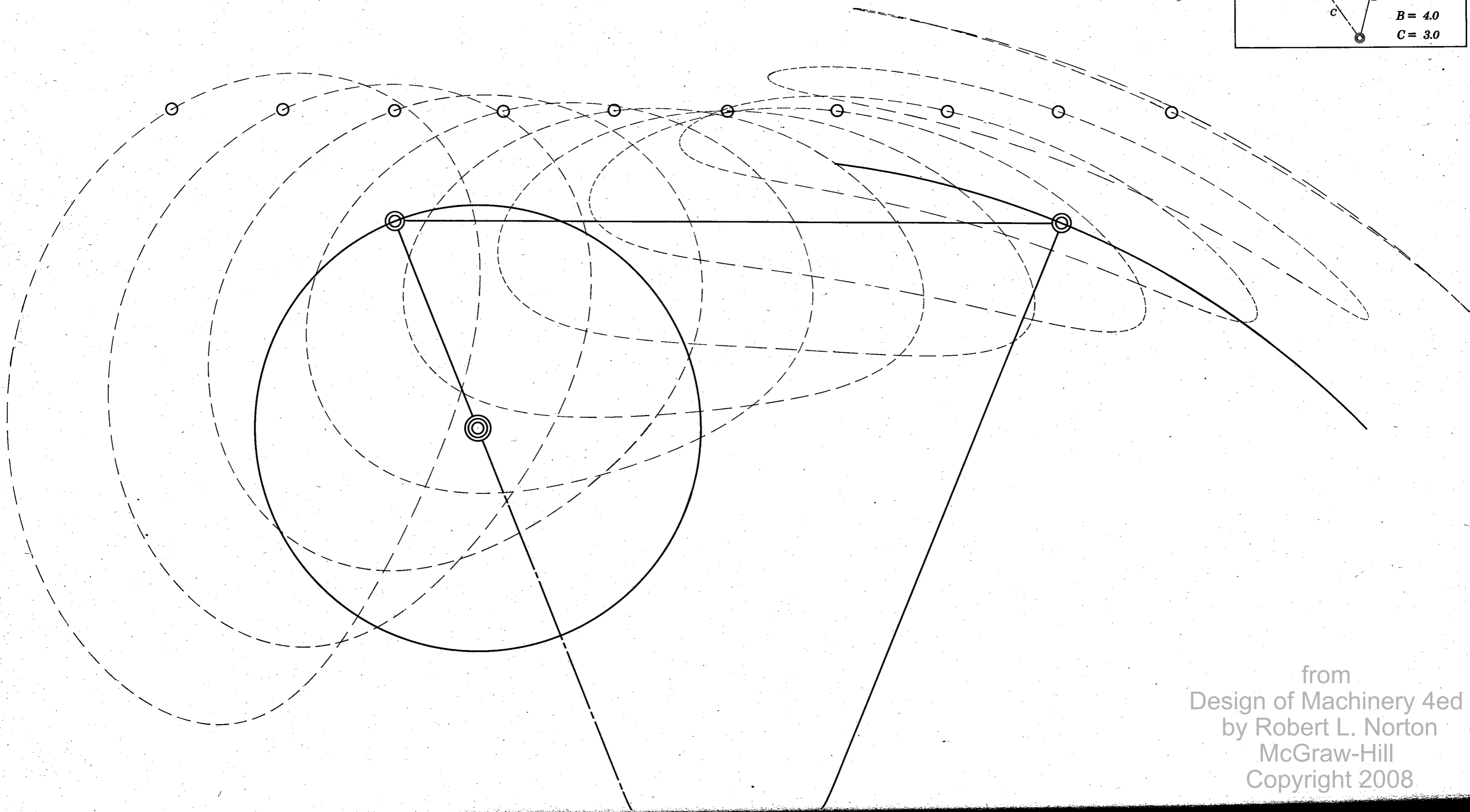
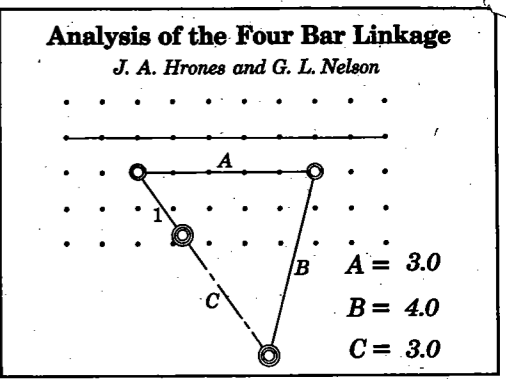

from  
Design of Machinery 4ed  
by Robert L. Norton  
McGraw-Hill  
Copyright 2008

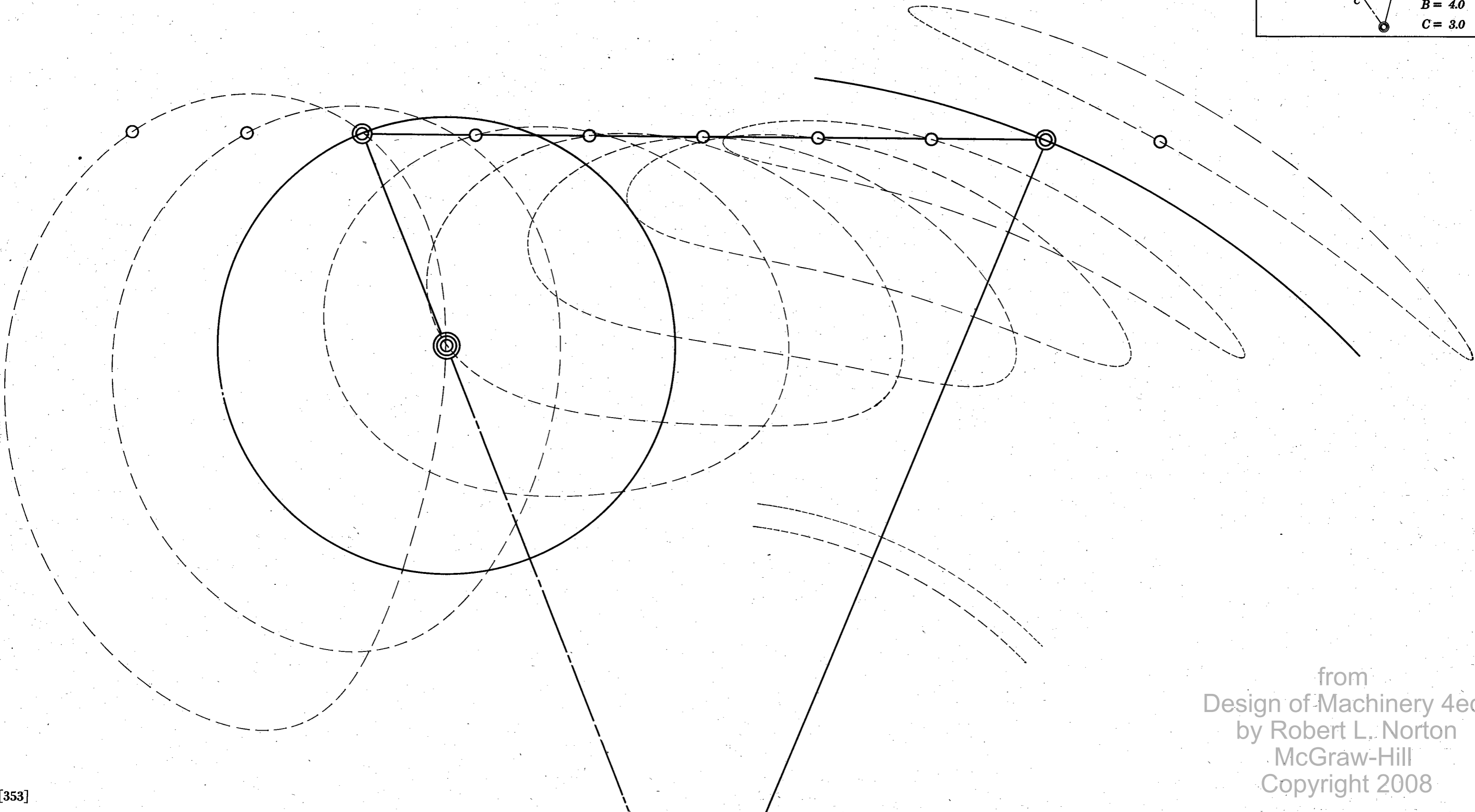
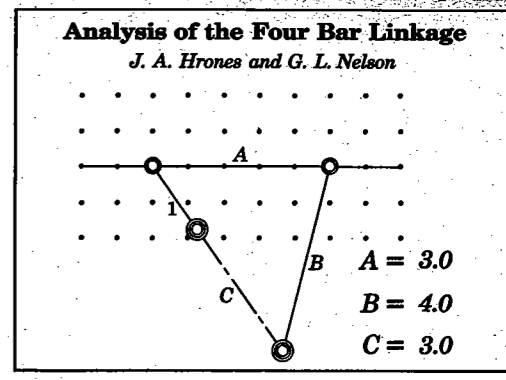

from  
 Design of Machinery 4ed  
 by Robert L. Norton  
 McGraw-Hill  
 Copyright 2008



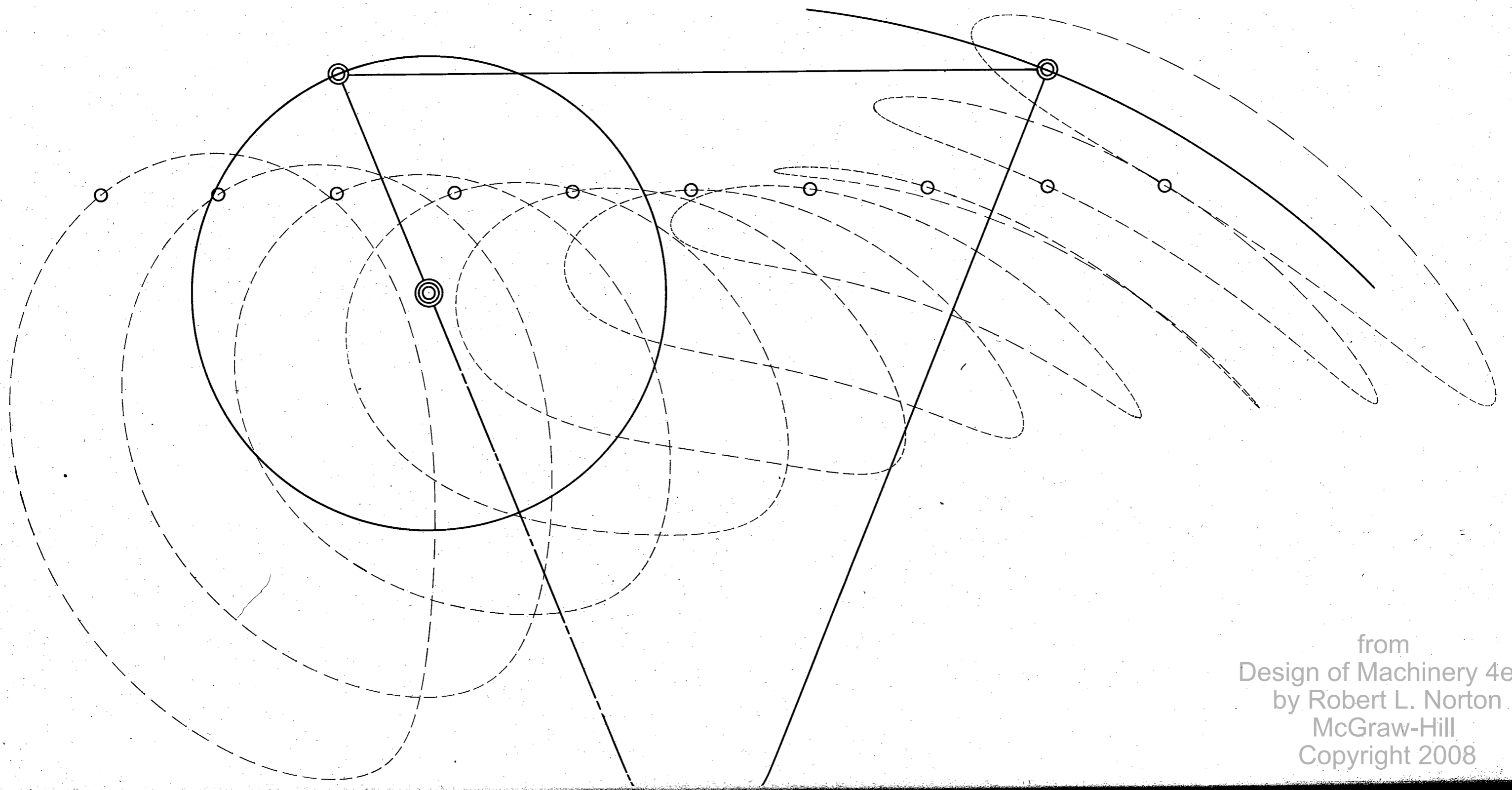
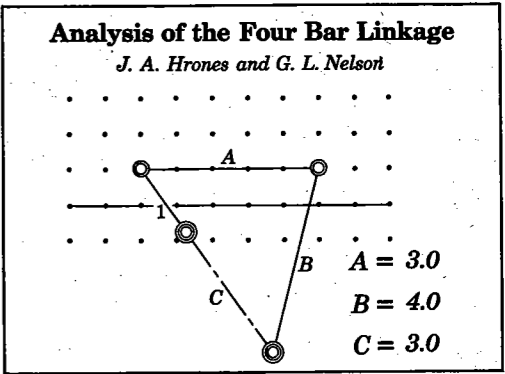

from  
Design of Machinery 4ed  
by Robert L. Norton  
McGraw-Hill  
Copyright 2008

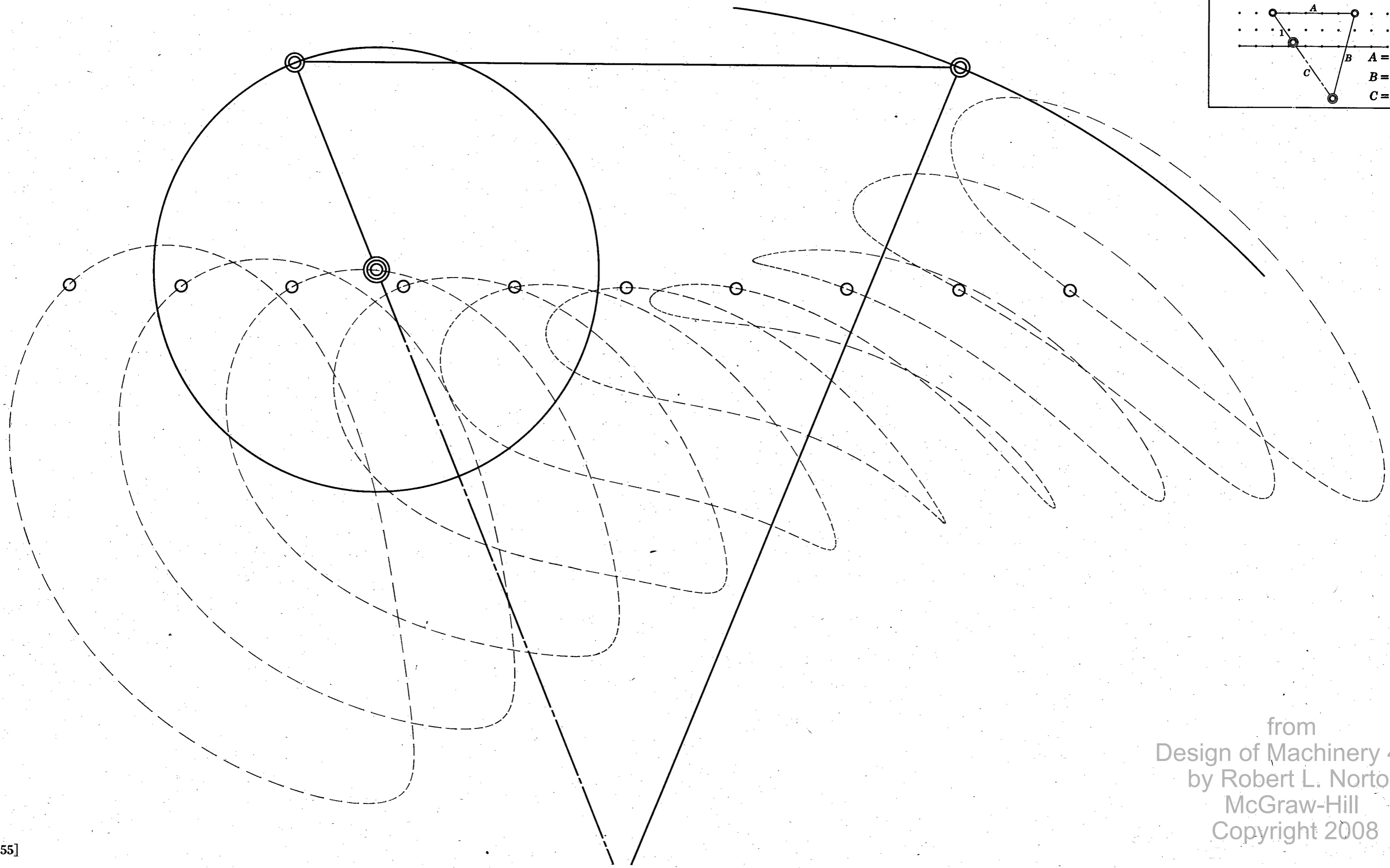
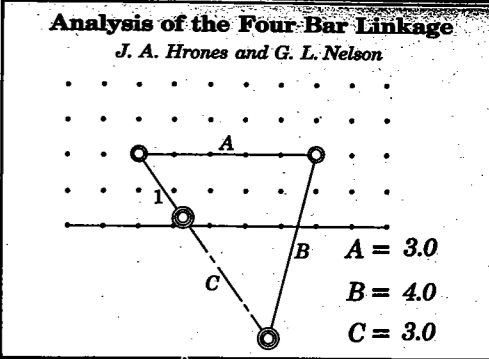

from  
 Design of Machinery 4ed  
 by Robert L. Norton  
 McGraw-Hill  
 Copyright 2008

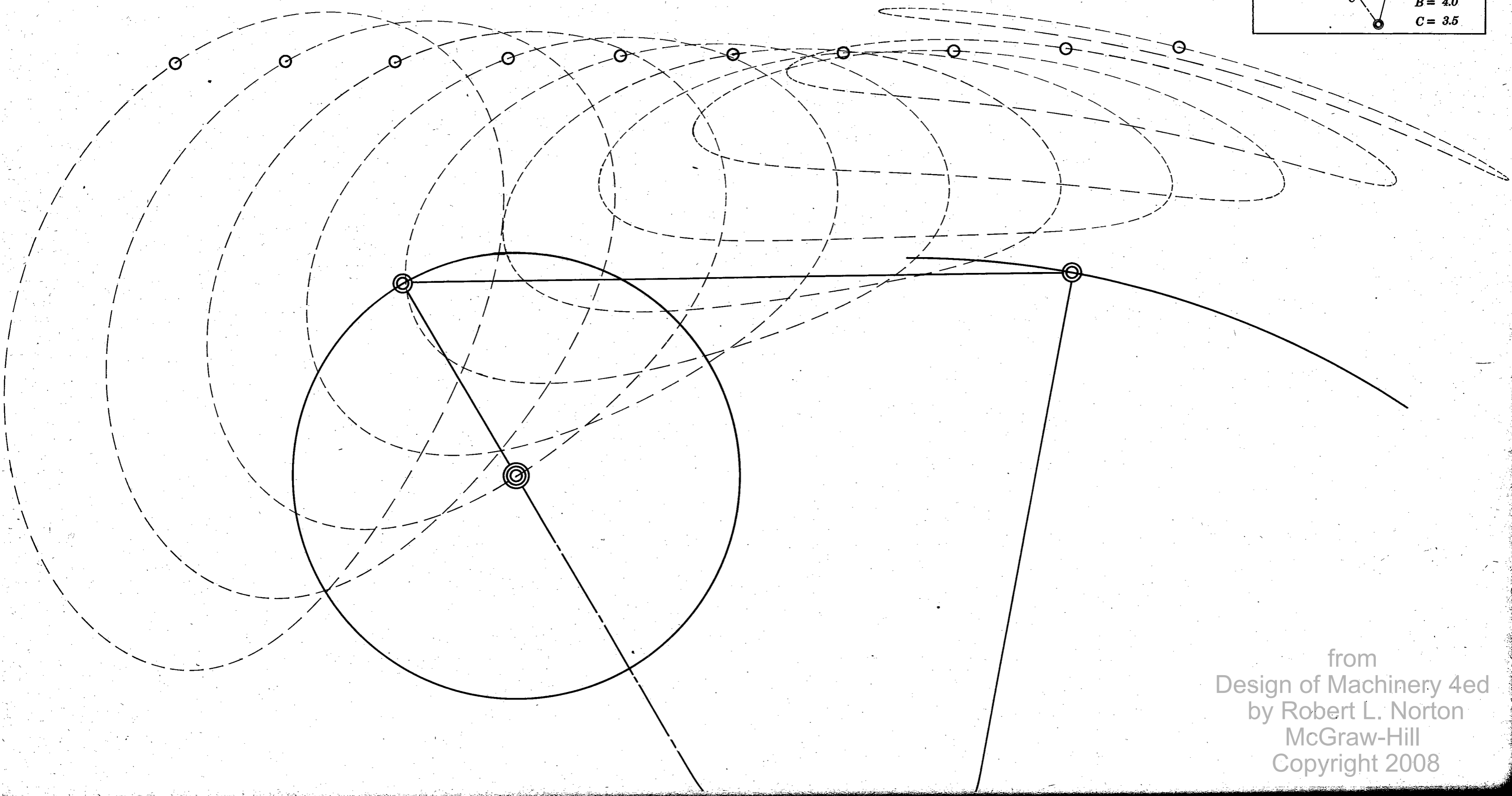
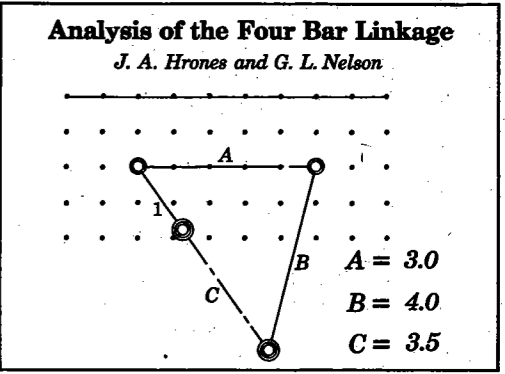

from  
Design of Machinery 4ed  
by Robert L. Norton  
McGraw-Hill  
Copyright 2008

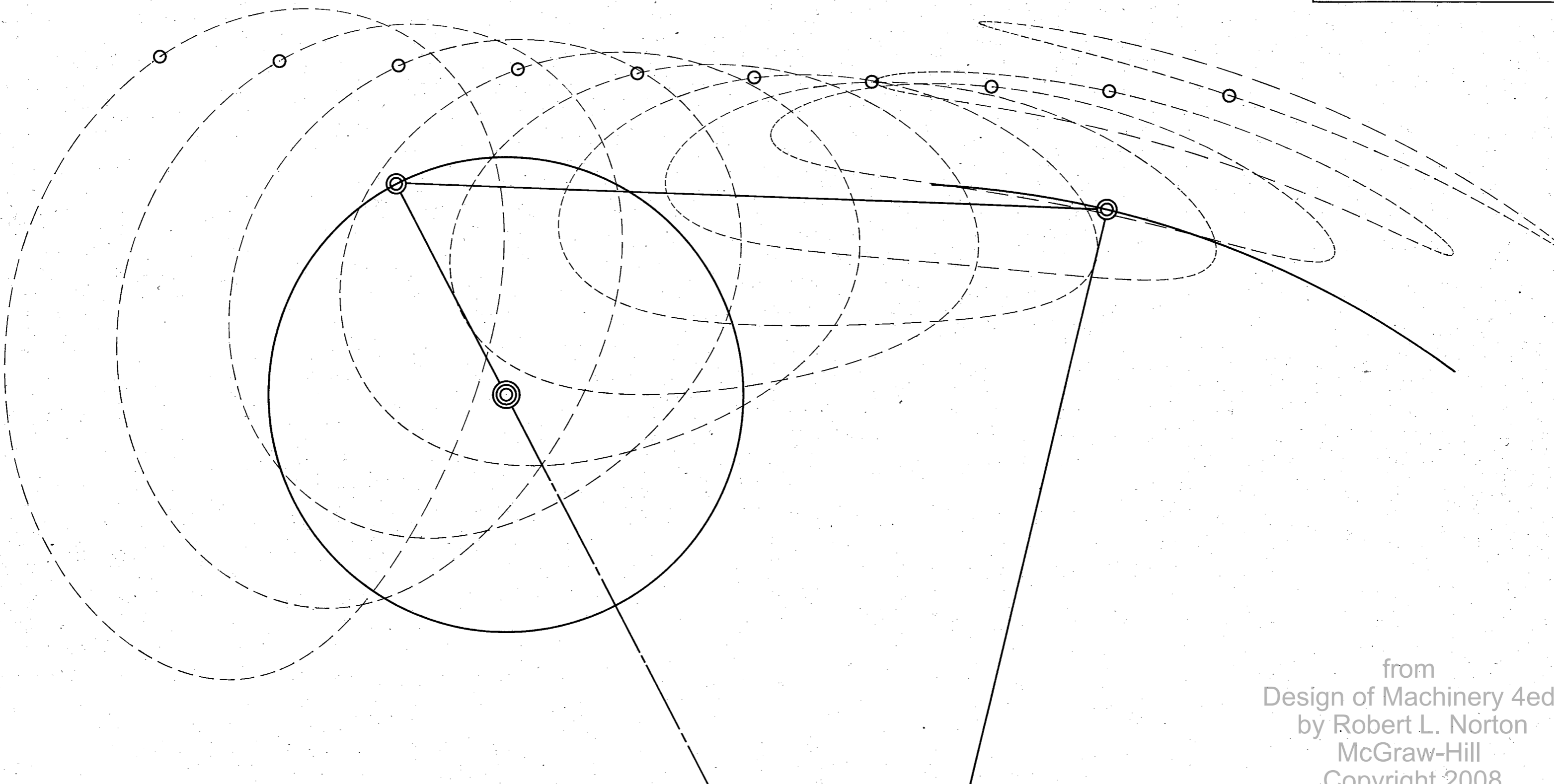
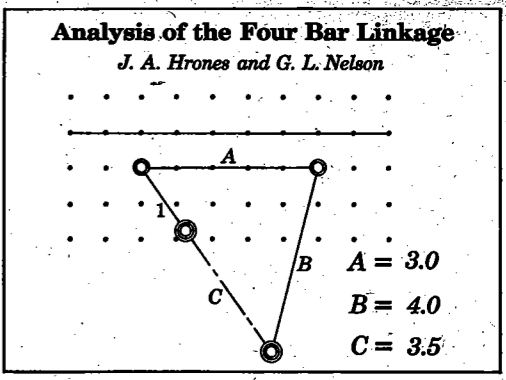

from  
 Design of Machinery 4ed  
 by Robert L. Norton  
 McGraw-Hill  
 Copyright 2008

**Analysis of the Four Bar Linkage**  
*J. A. Hrones and G. L. Nelson*

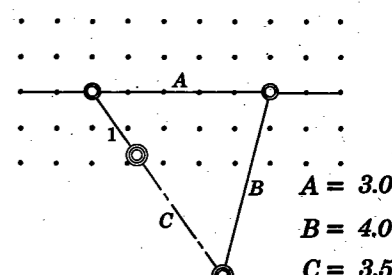

$A = 3.0$   
 $B = 4.0$   
 $C = 3.5$

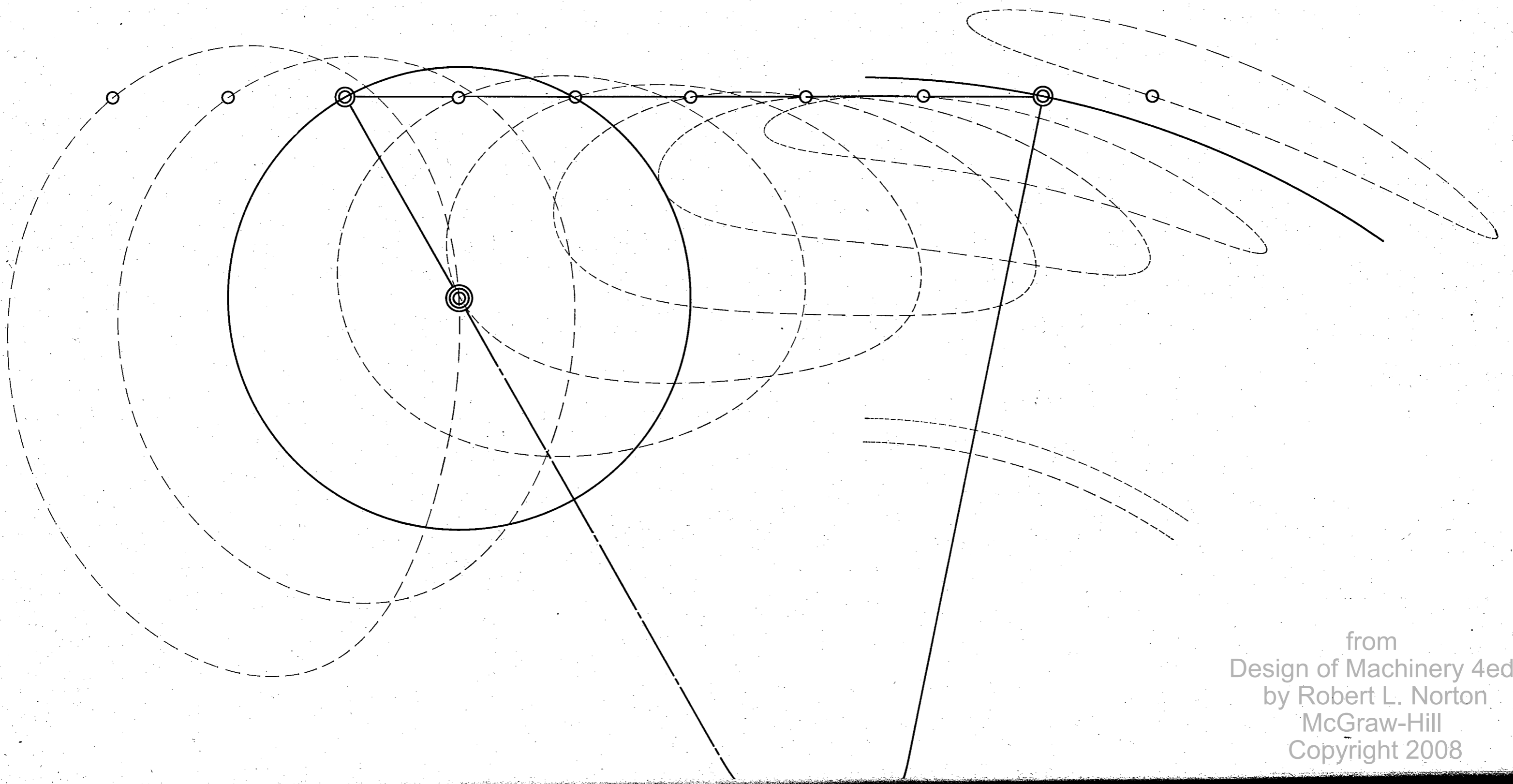

from  
Design of Machinery 4ed  
by Robert L. Norton  
McGraw-Hill  
Copyright 2008

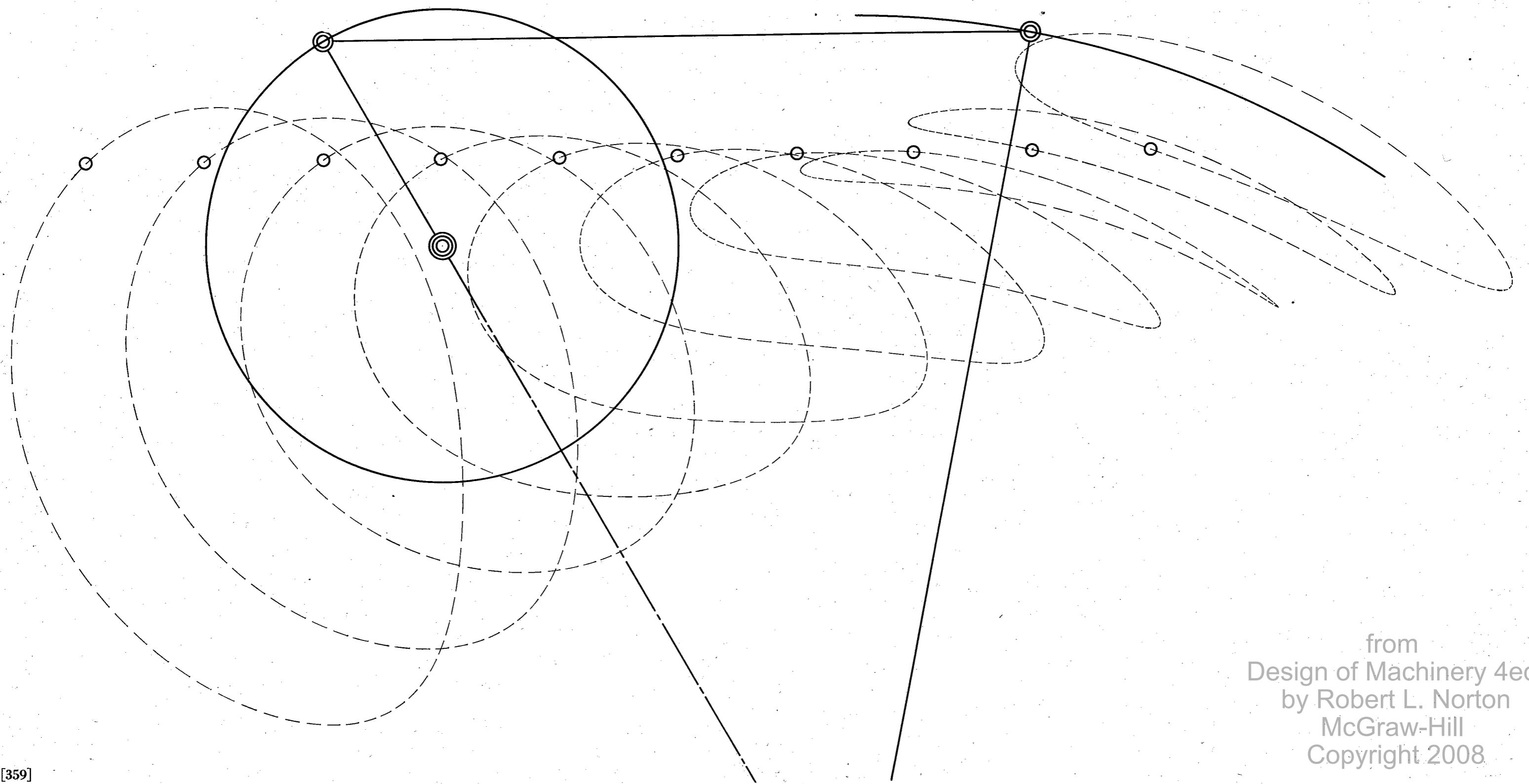
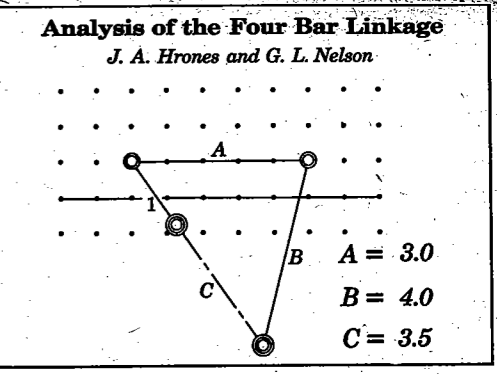

from  
 Design of Machinery 4ed  
 by Robert L. Norton  
 McGraw-Hill  
 Copyright 2008

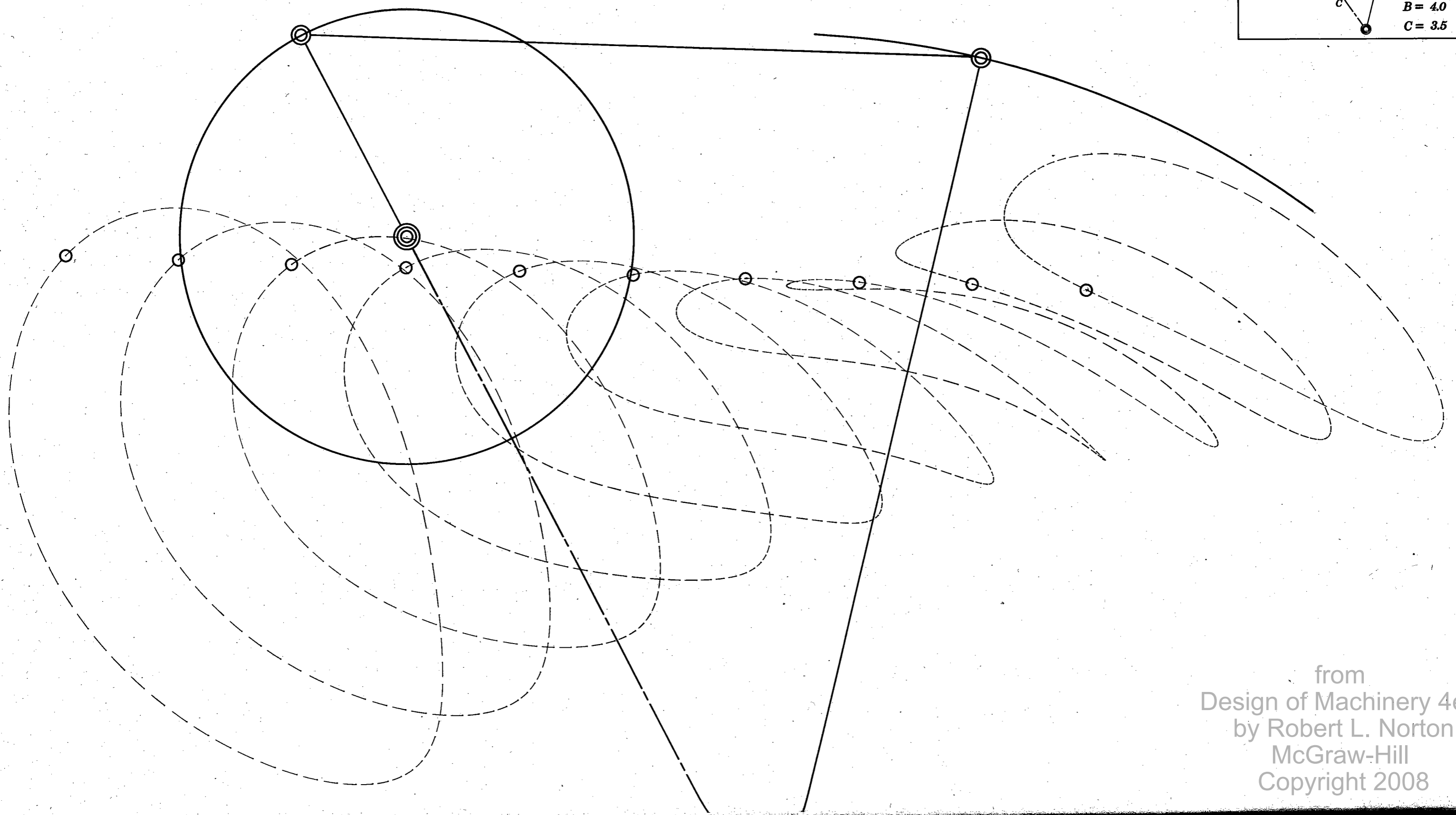
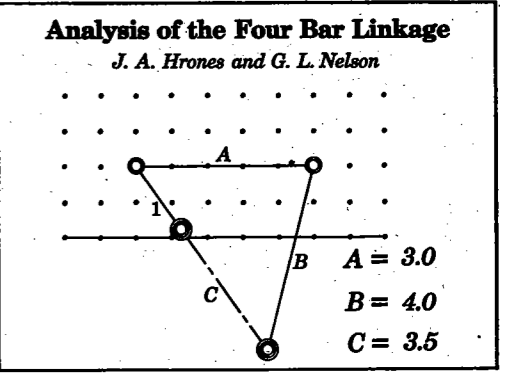

from  
Design of Machinery 4ed  
by Robert L. Norton  
McGraw-Hill  
Copyright 2008

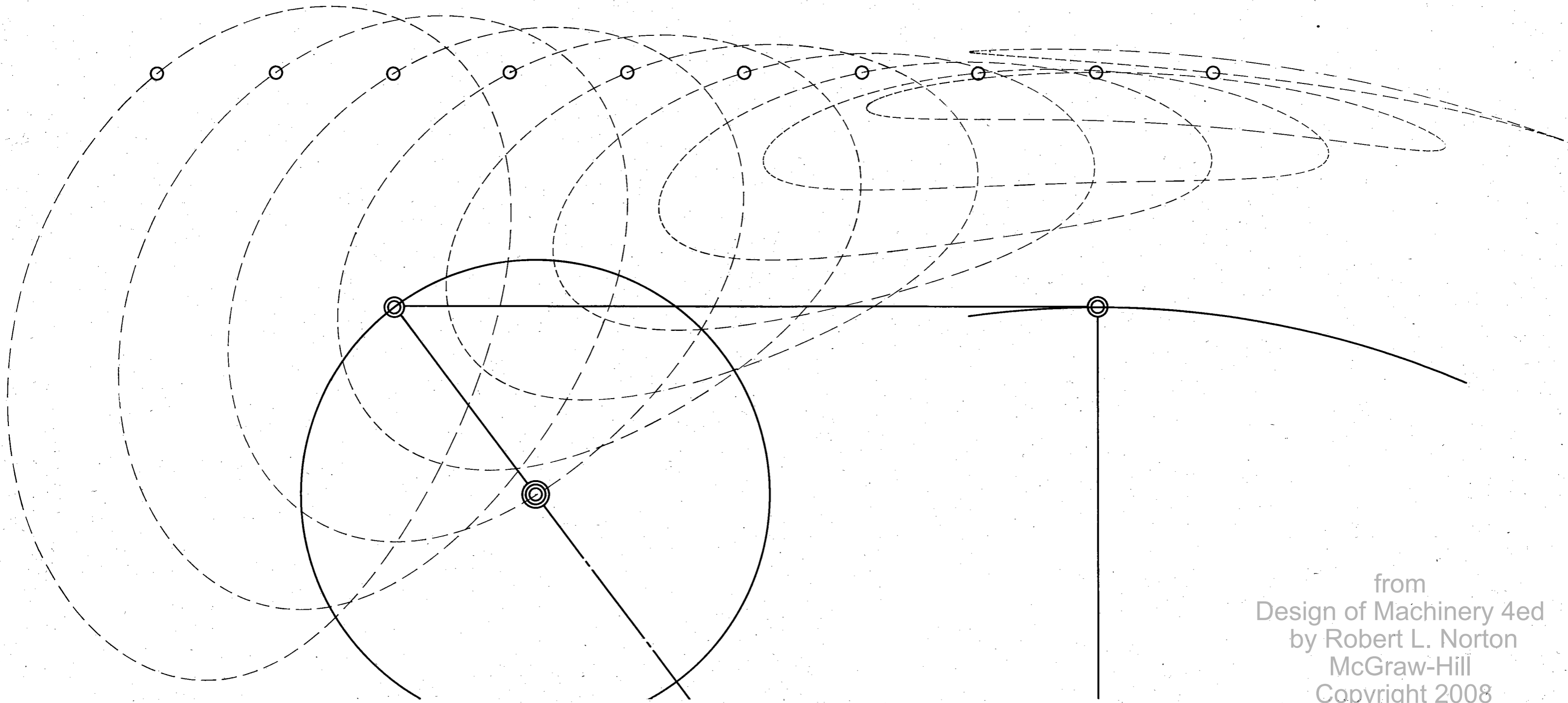
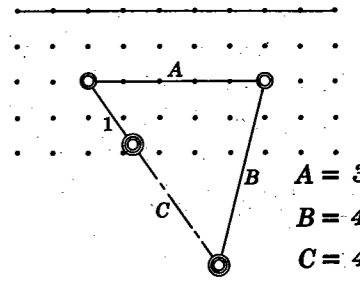

from  
Design of Machinery 4ed  
by Robert L. Norton  
McGraw-Hill  
Copyright 2008



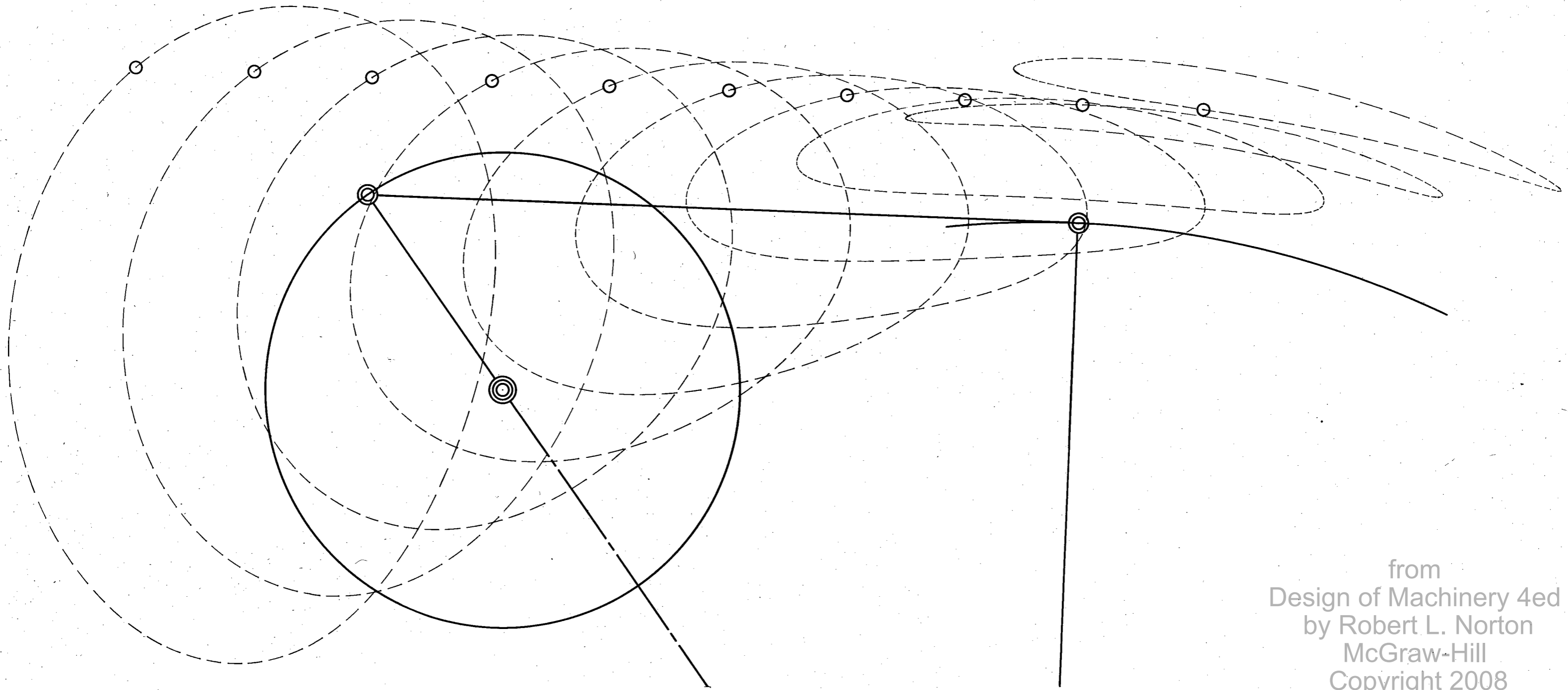
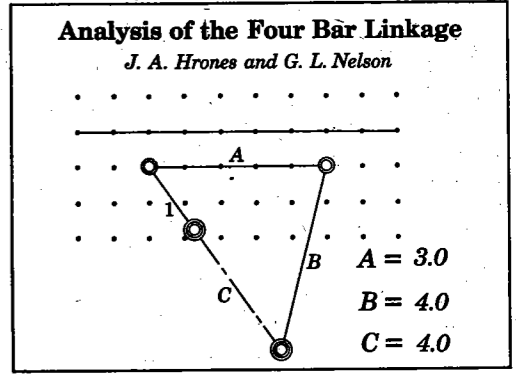

from  
Design of Machinery 4ed  
by Robert L. Norton  
McGraw-Hill  
Copyright 2008

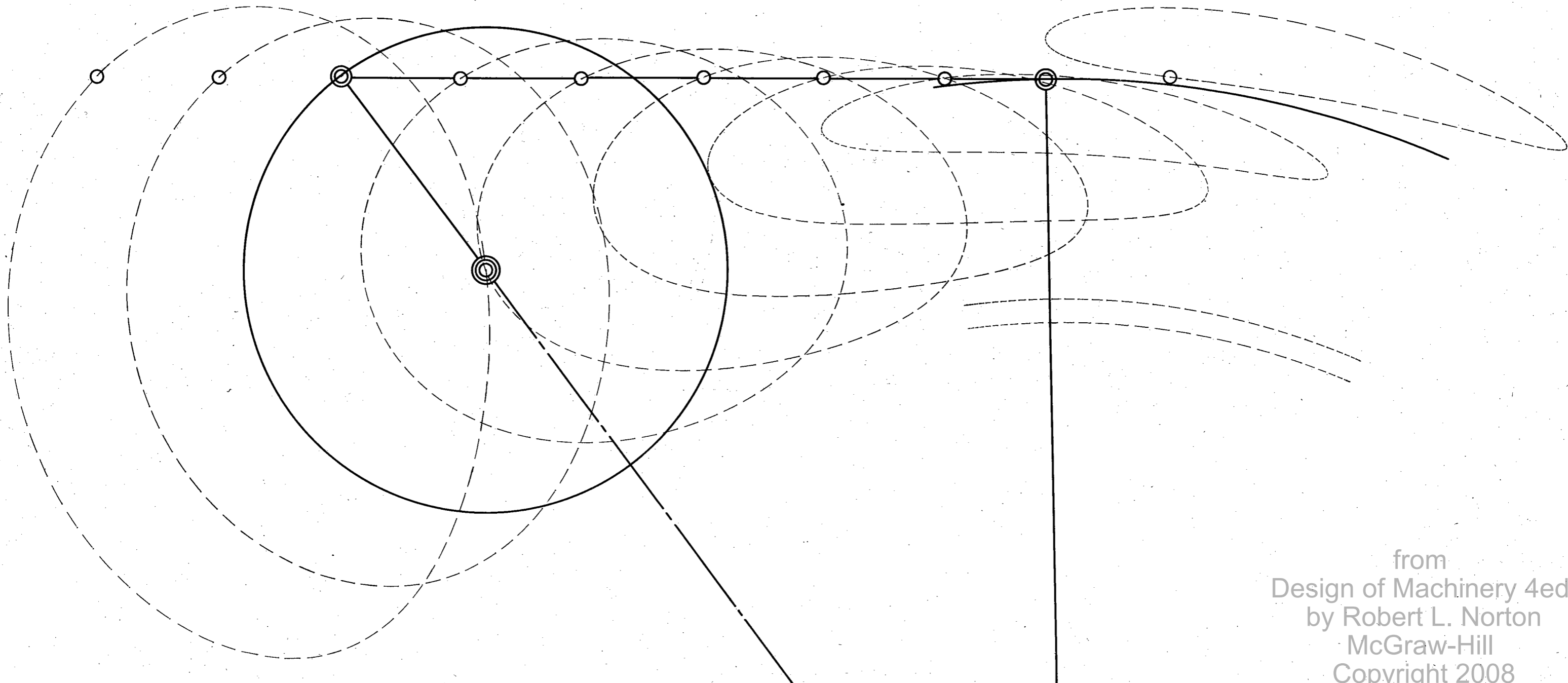
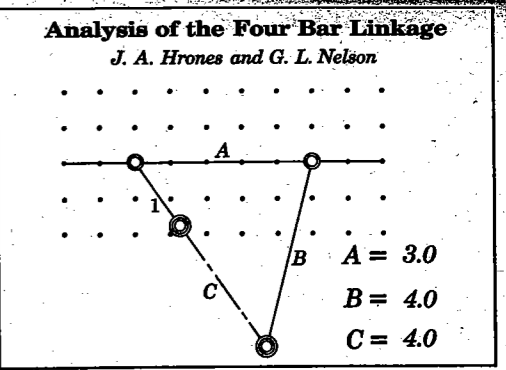

from  
 Design of Machinery 4ed  
 by Robert L. Norton  
 McGraw-Hill  
 Copyright 2008

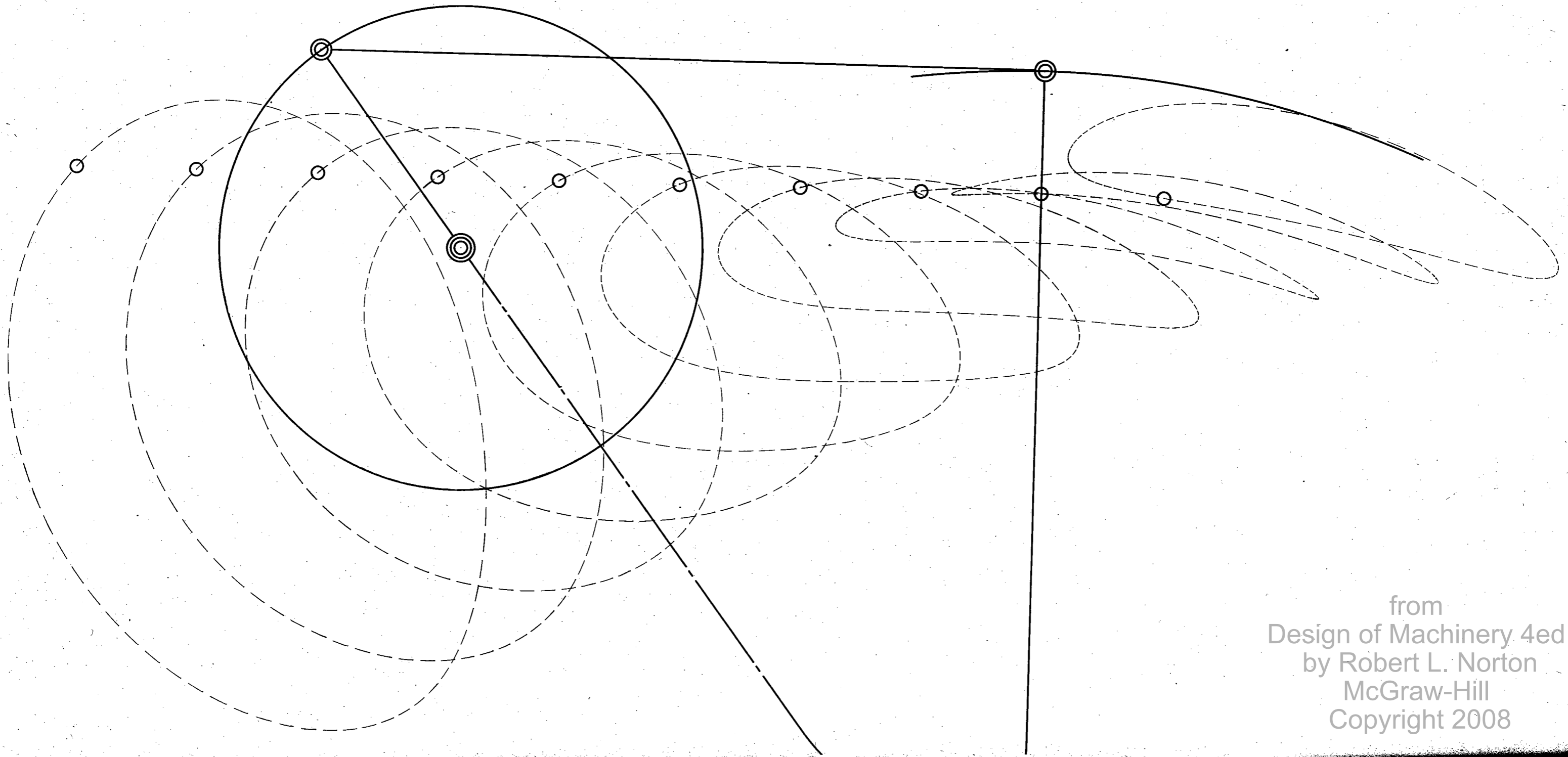
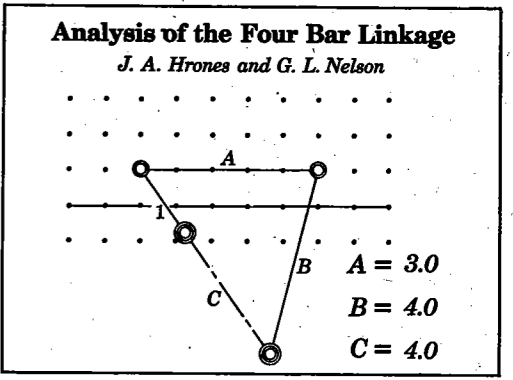

from  
Design of Machinery 4ed  
by Robert L. Norton  
McGraw-Hill  
Copyright 2008

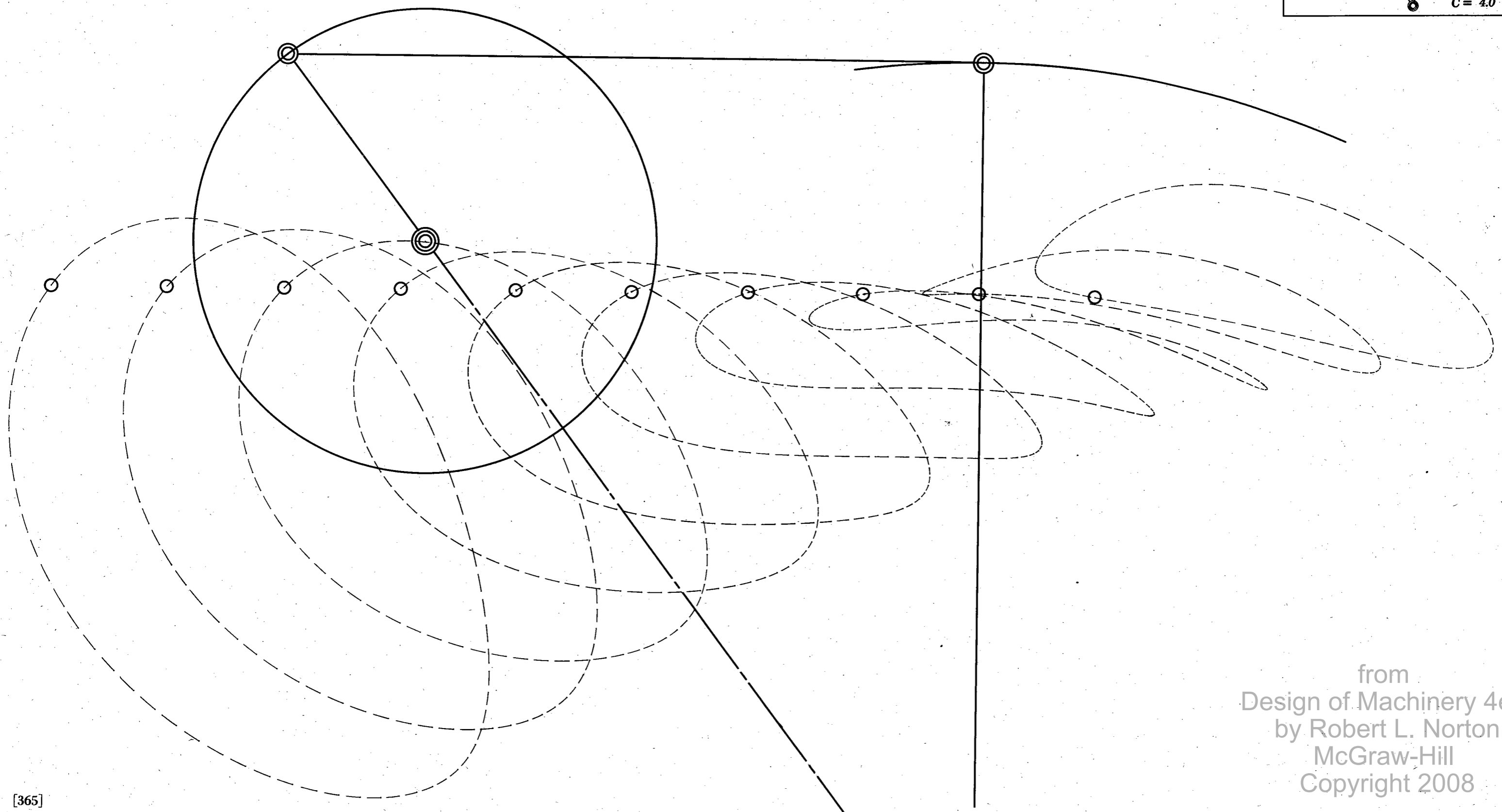
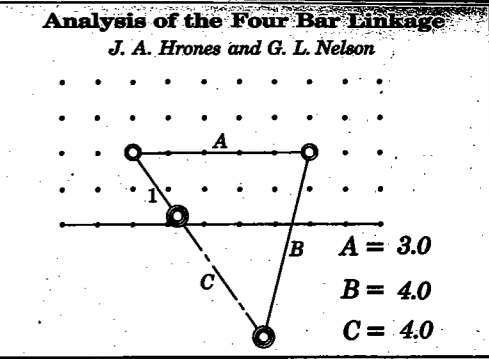

from  
 Design of Machinery 4ed  
 by Robert L. Norton  
 McGraw-Hill  
 Copyright 2008

**Analysis of the Four Bar Linkage**

*J. A. Hrones and G. L. Nelson*

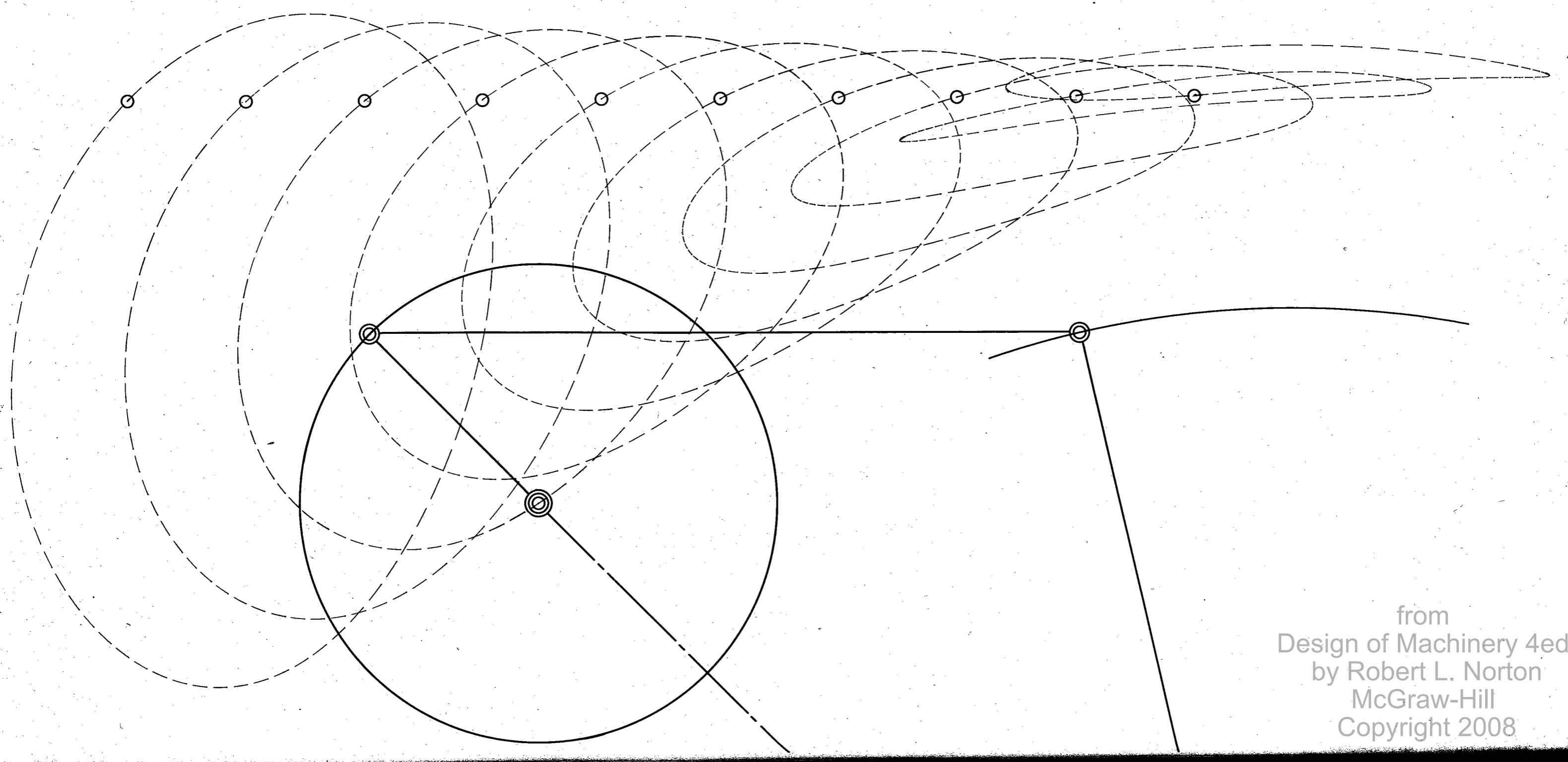
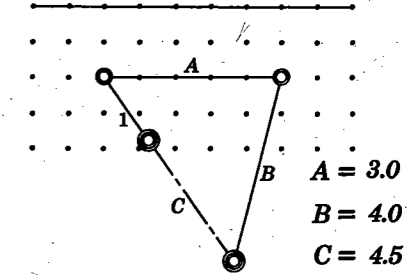

from  
Design of Machinery 4ed  
by Robert L. Norton  
McGraw-Hill  
Copyright 2008

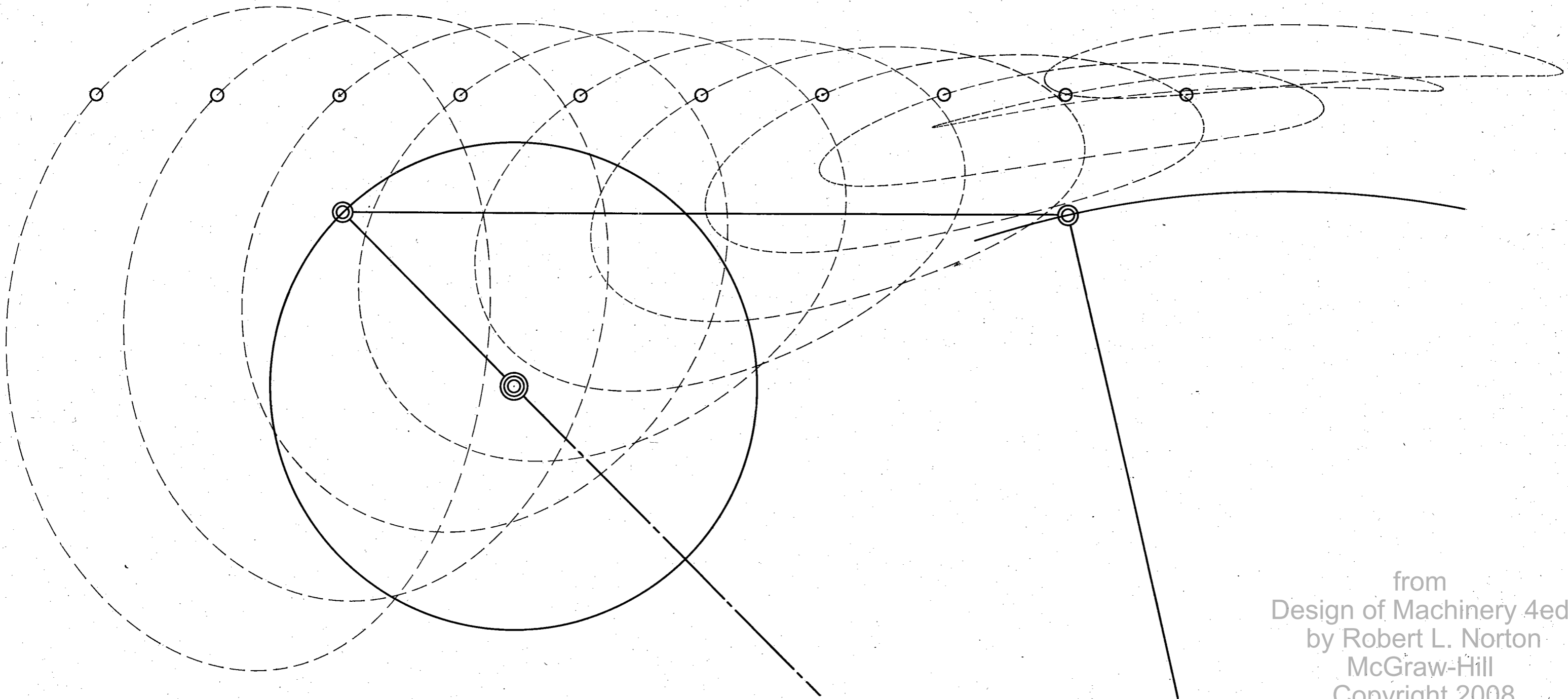
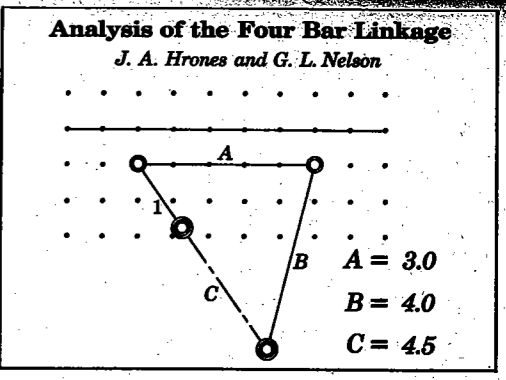

from  
 Design of Machinery 4ed  
 by Robert L. Norton  
 McGraw-Hill  
 Copyright 2008

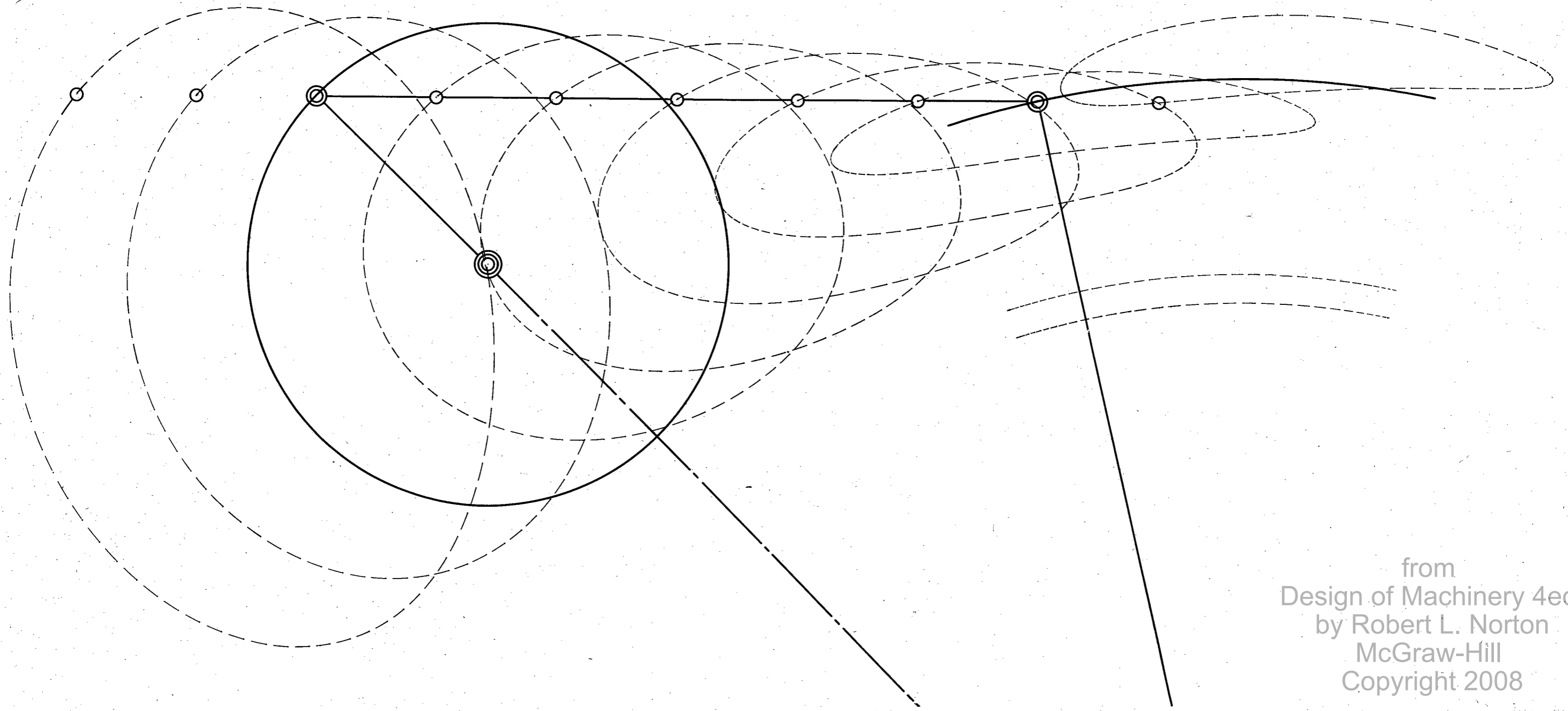
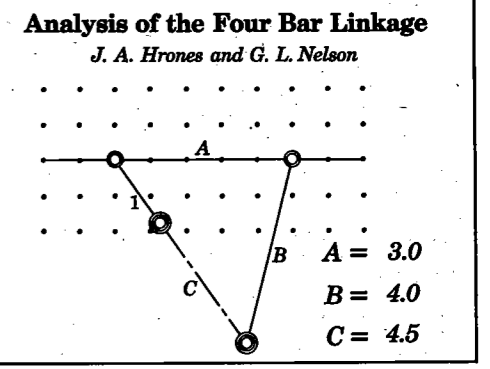

from  
Design of Machinery 4ed  
by Robert L. Norton  
McGraw-Hill  
Copyright 2008

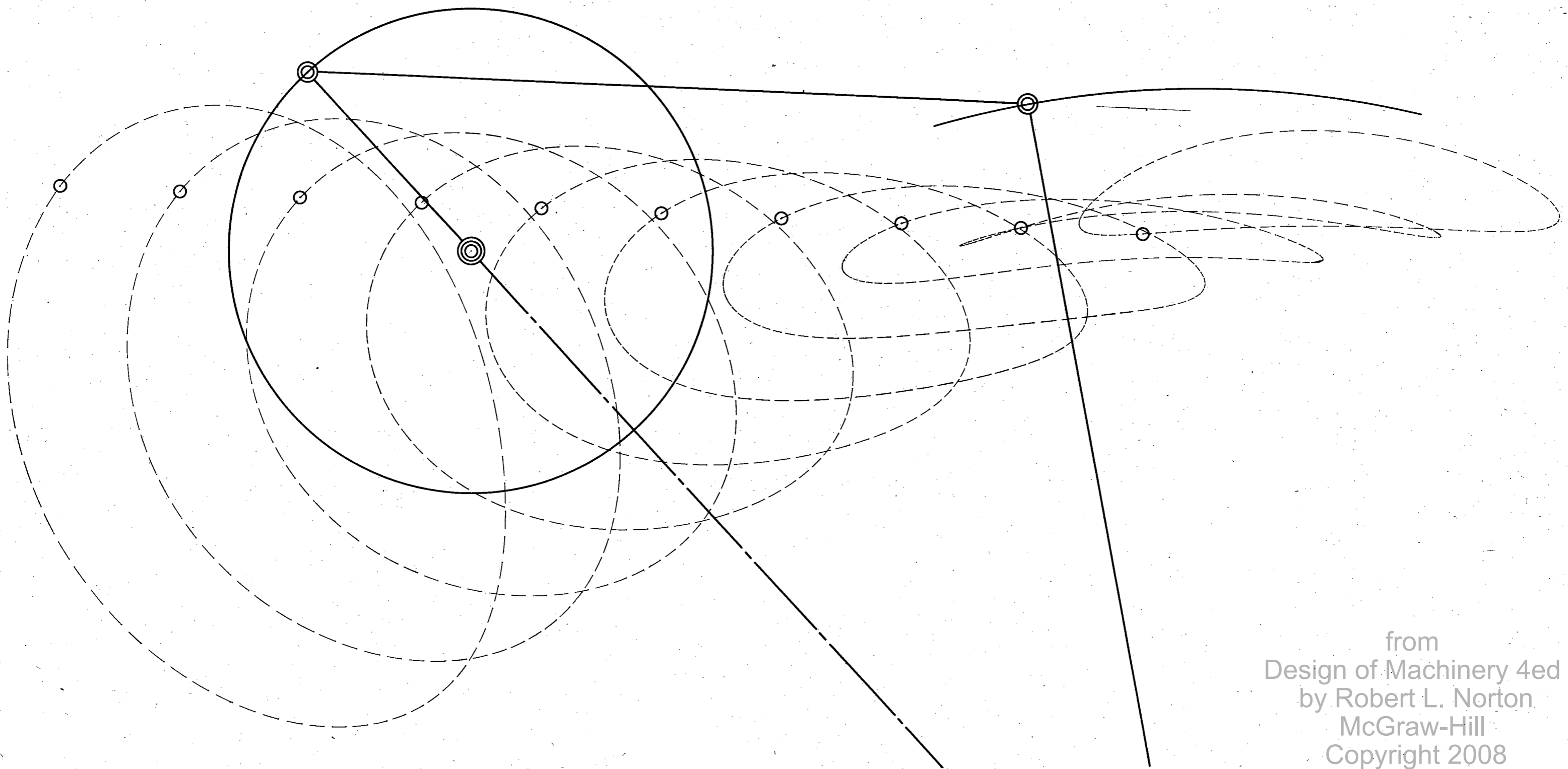
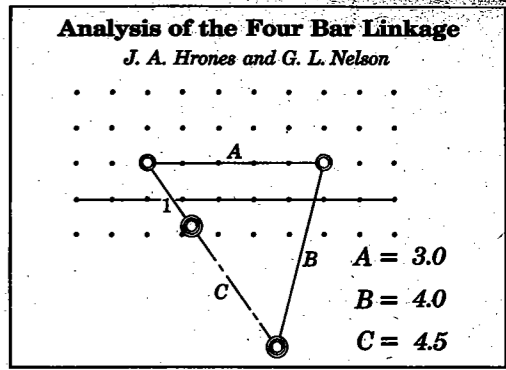

from  
 Design of Machinery 4ed  
 by Robert L. Norton  
 McGraw-Hill  
 Copyright 2008



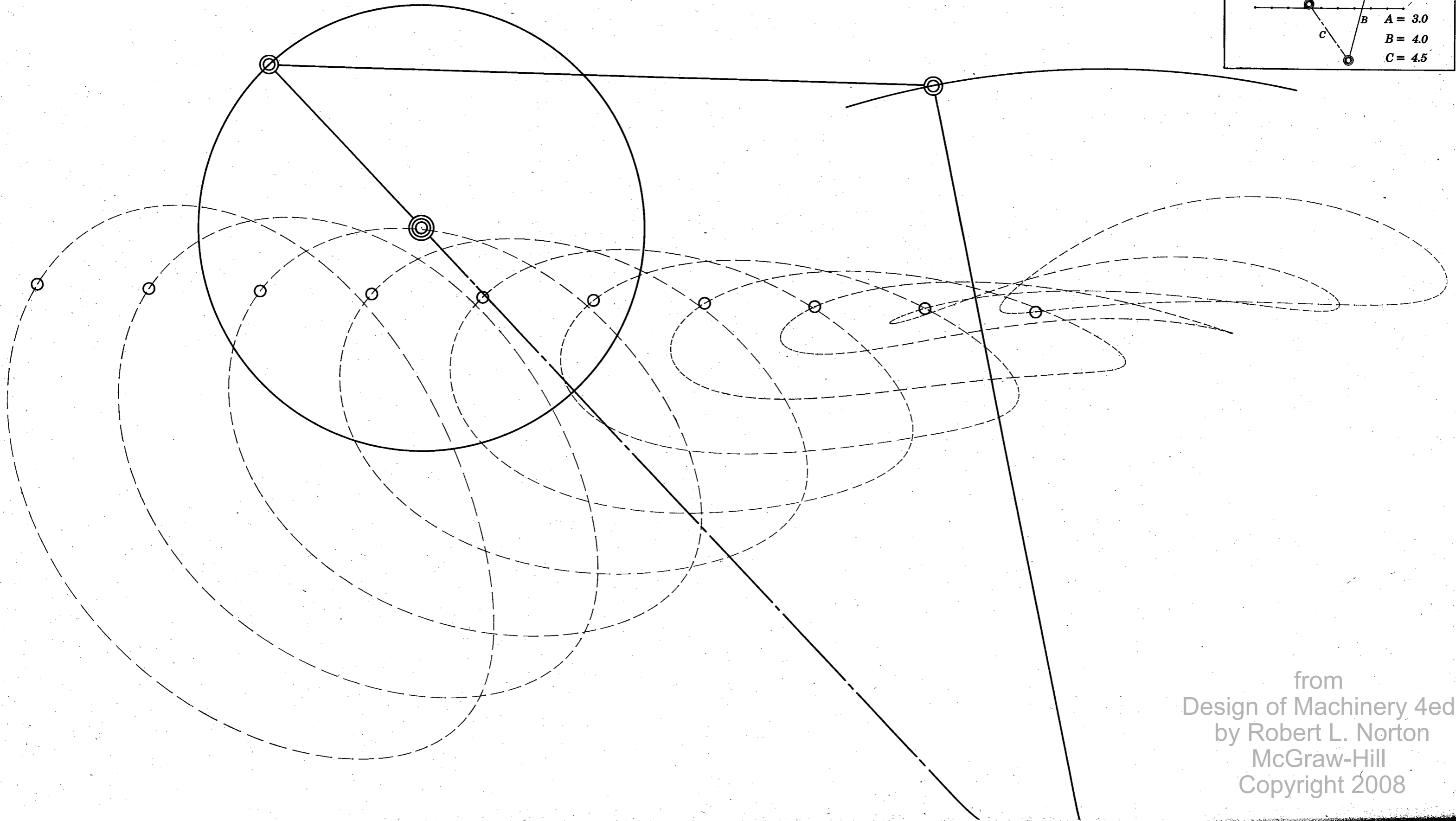
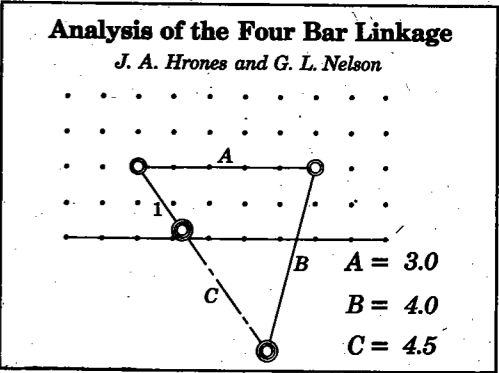

from  
Design of Machinery 4ed  
by Robert L. Norton  
McGraw-Hill  
Copyright 2008

**Analysis of the Four Bar Linkage**

*J. A. Hrones and G. L. Nelson*

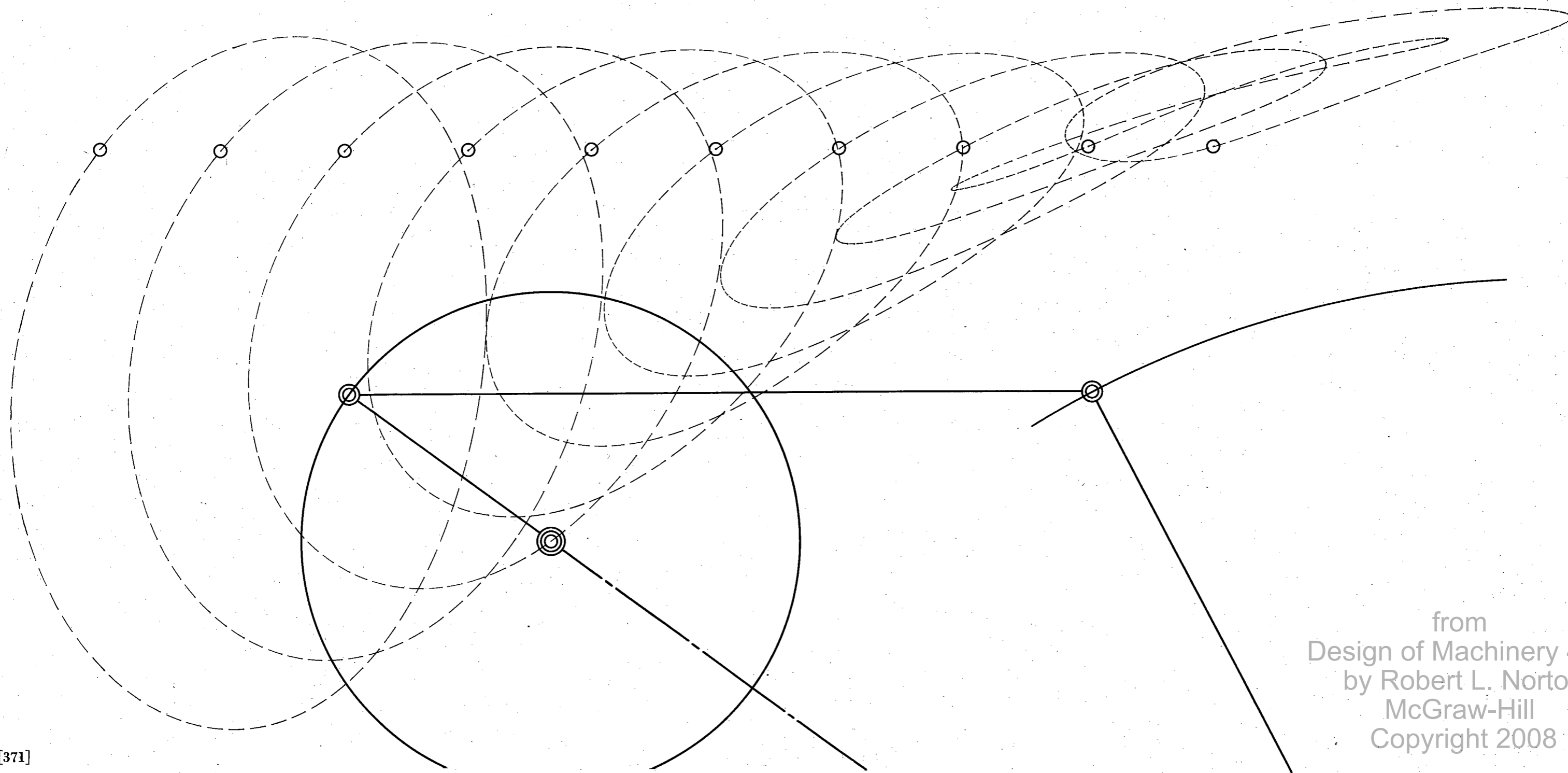
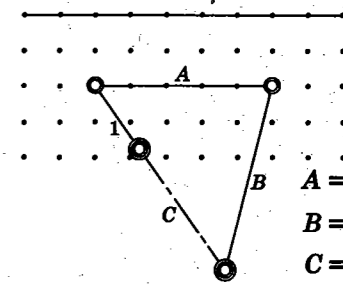

from  
Design of Machinery 4ed  
by Robert L. Norton  
McGraw-Hill  
Copyright 2008

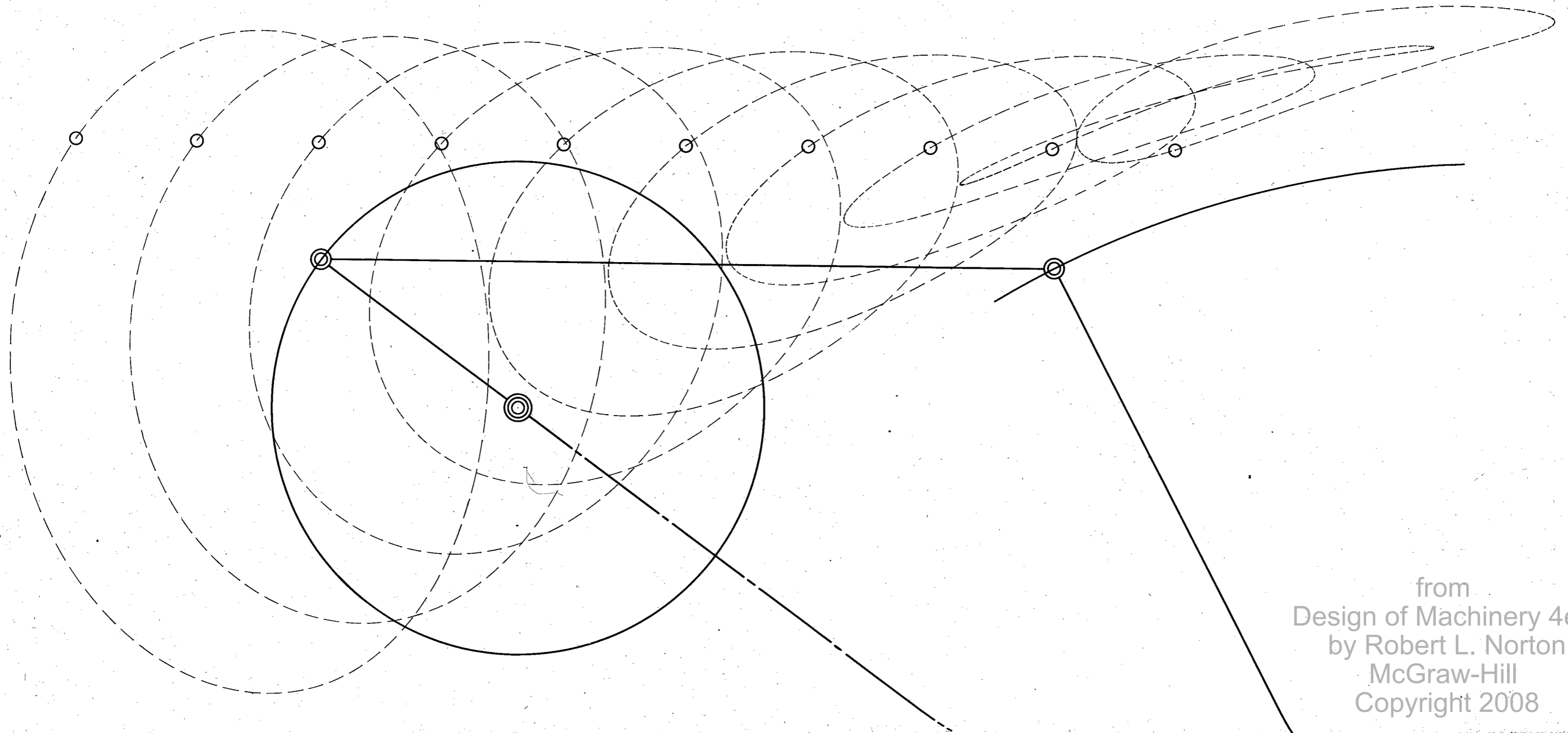
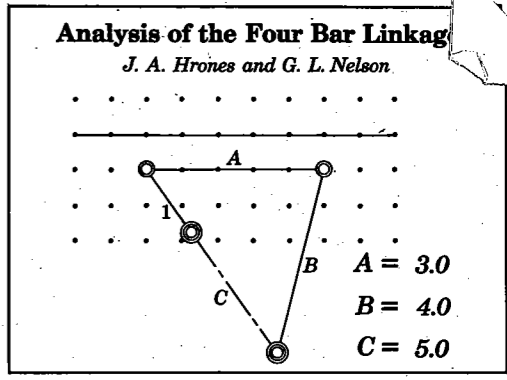

from  
Design of Machinery 4ed  
by Robert L. Norton  
McGraw-Hill  
Copyright 2008

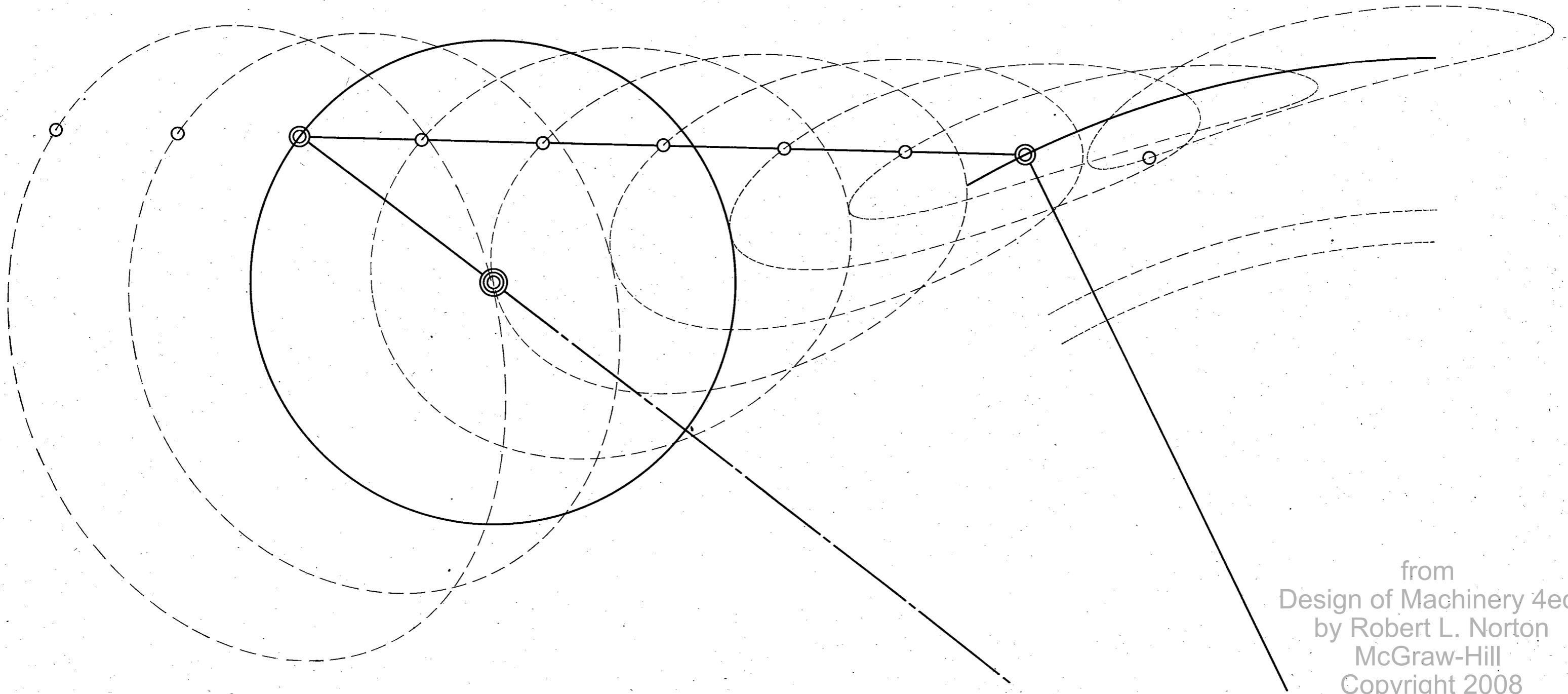
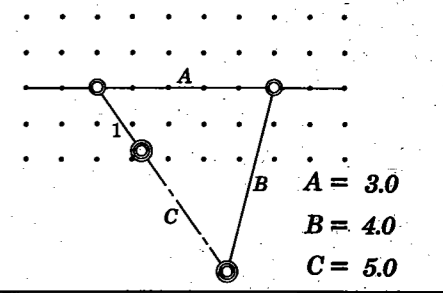

from  
Design of Machinery 4ed  
by Robert L. Norton  
McGraw-Hill  
Copyright 2008

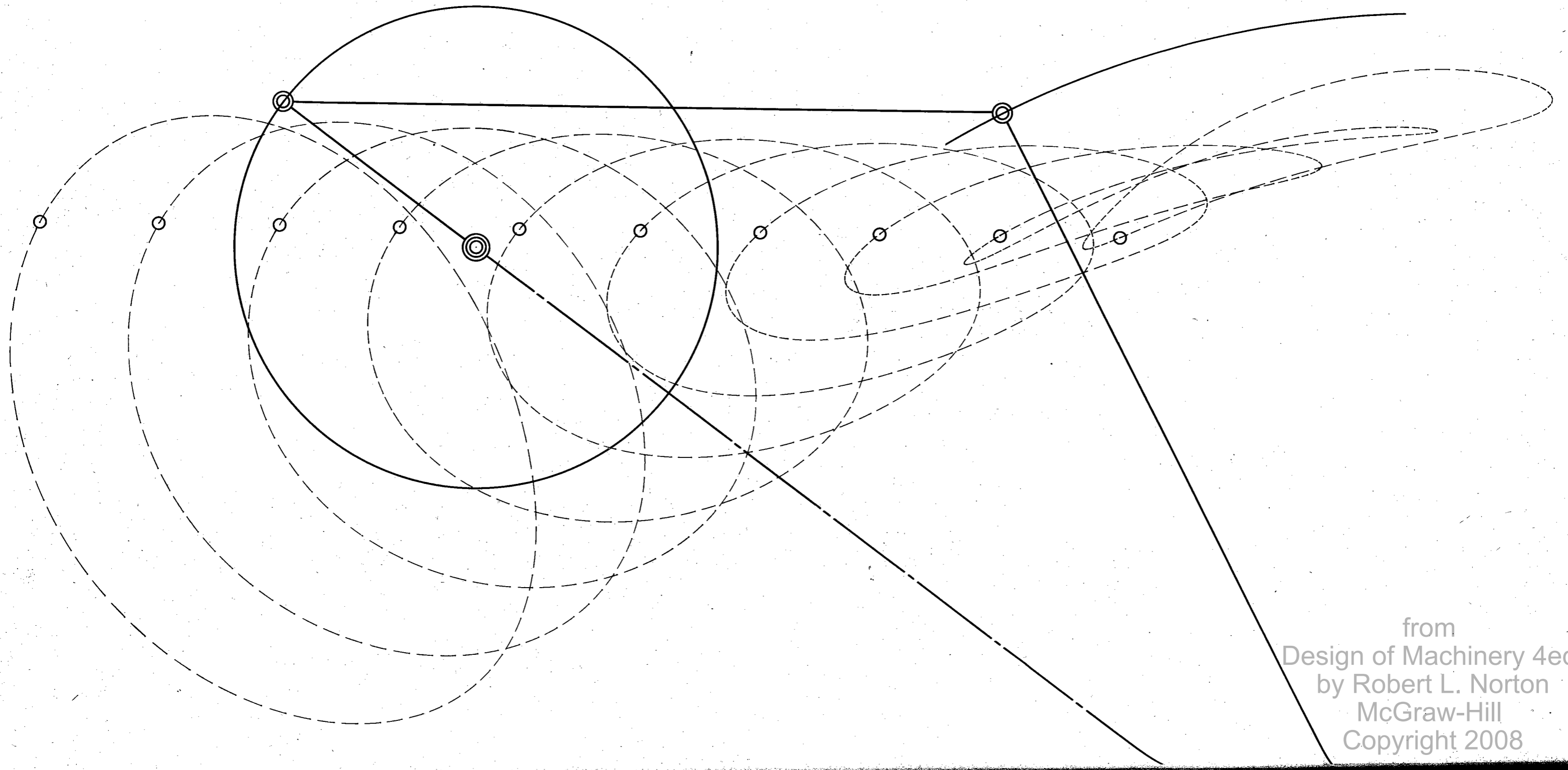
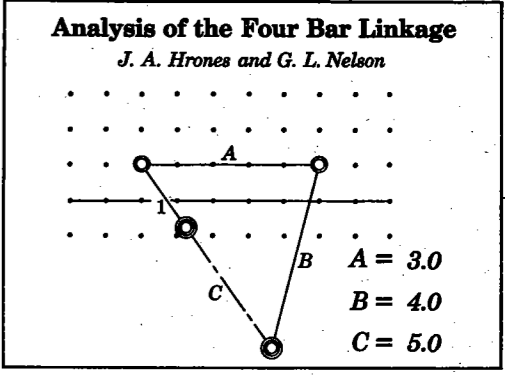

from  
Design of Machinery 4ed  
by Robert L. Norton  
McGraw-Hill  
Copyright 2008

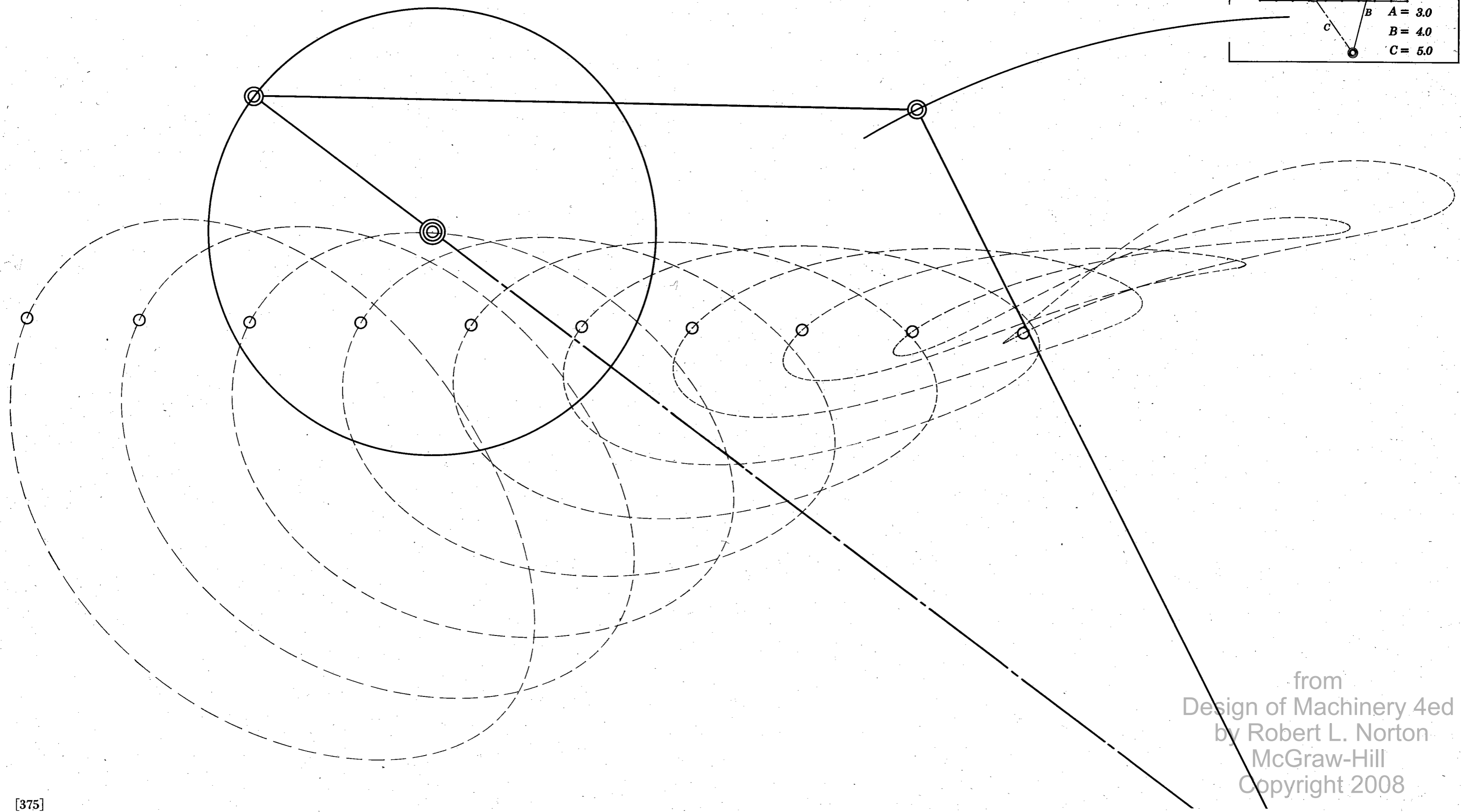
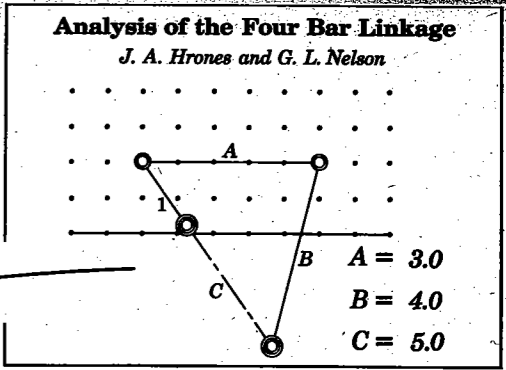

from  
Design of Machinery 4ed  
by Robert L. Norton  
McGraw-Hill  
Copyright 2008

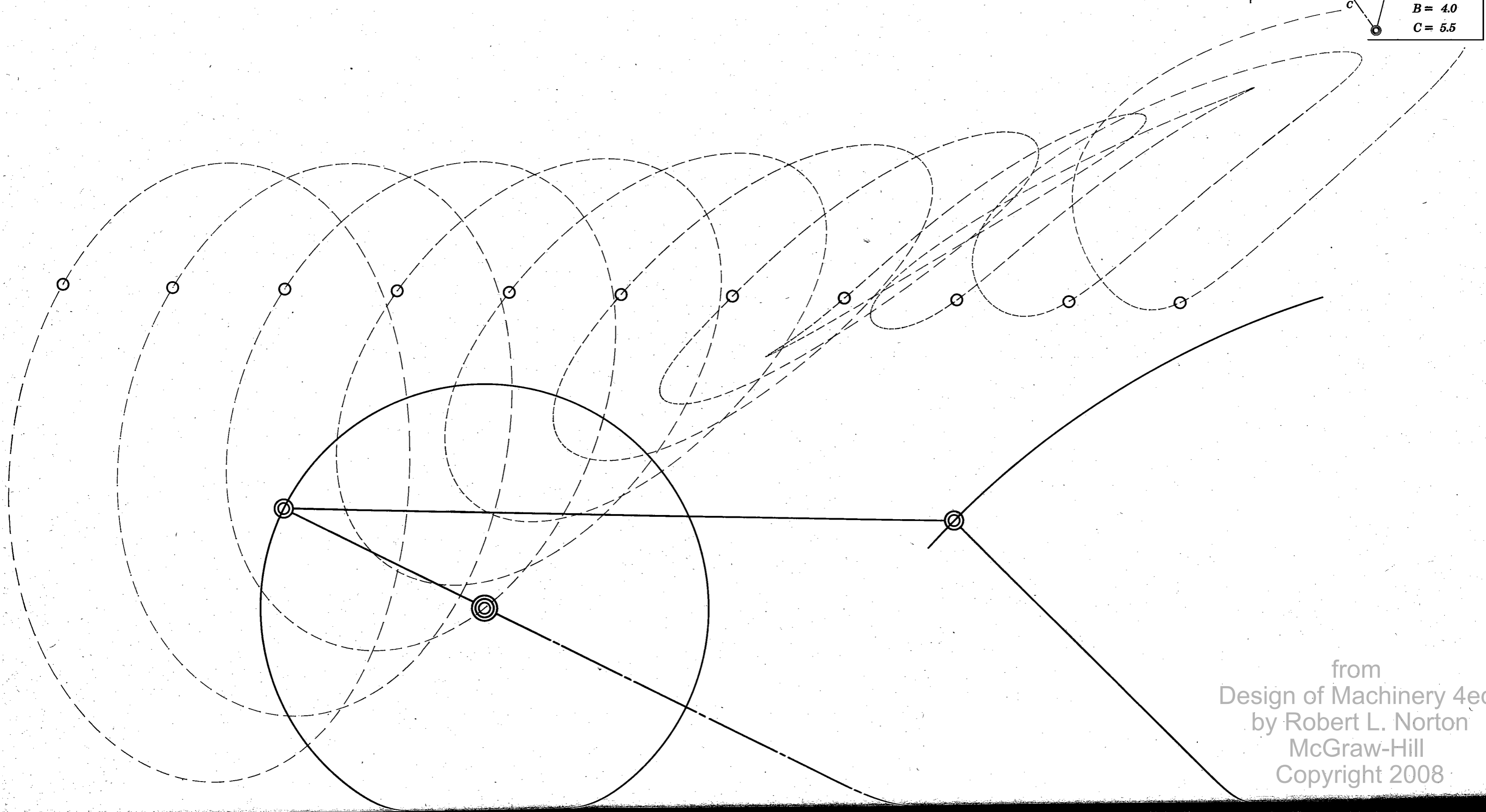
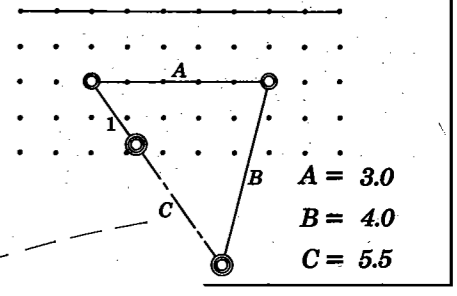

from  
Design of Machinery 4ed  
by Robert L. Norton  
McGraw-Hill  
Copyright 2008

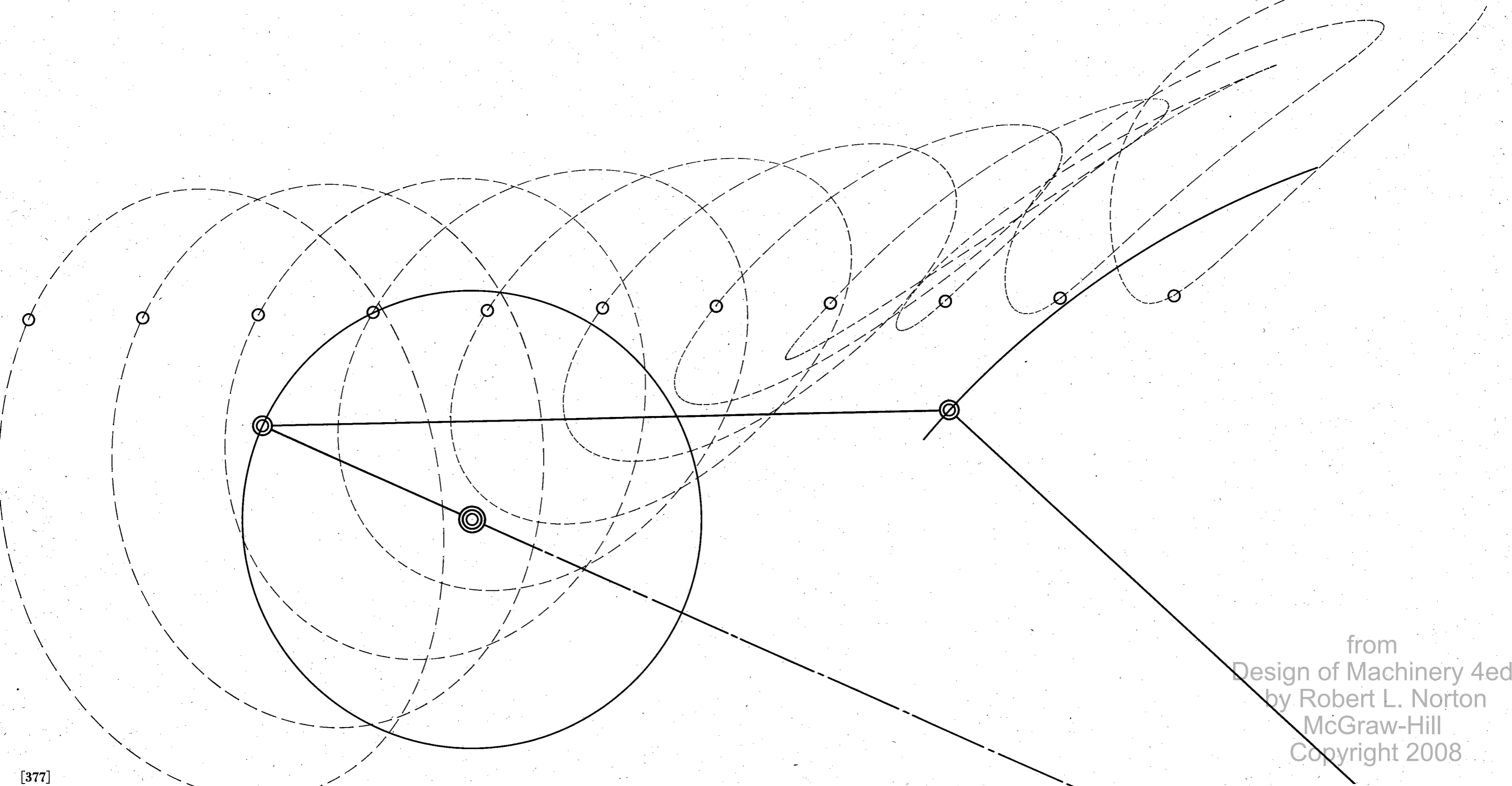
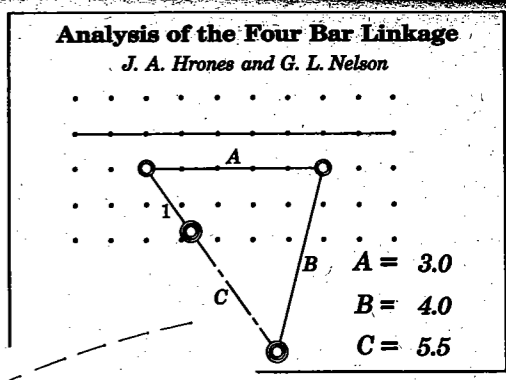

from  
 Design of Machinery 4ed  
 by Robert L. Norton  
 McGraw-Hill  
 Copyright 2008



**Analysis of the Four Bar Linkage**

*J. A. Hrones and G. L. Nelson*

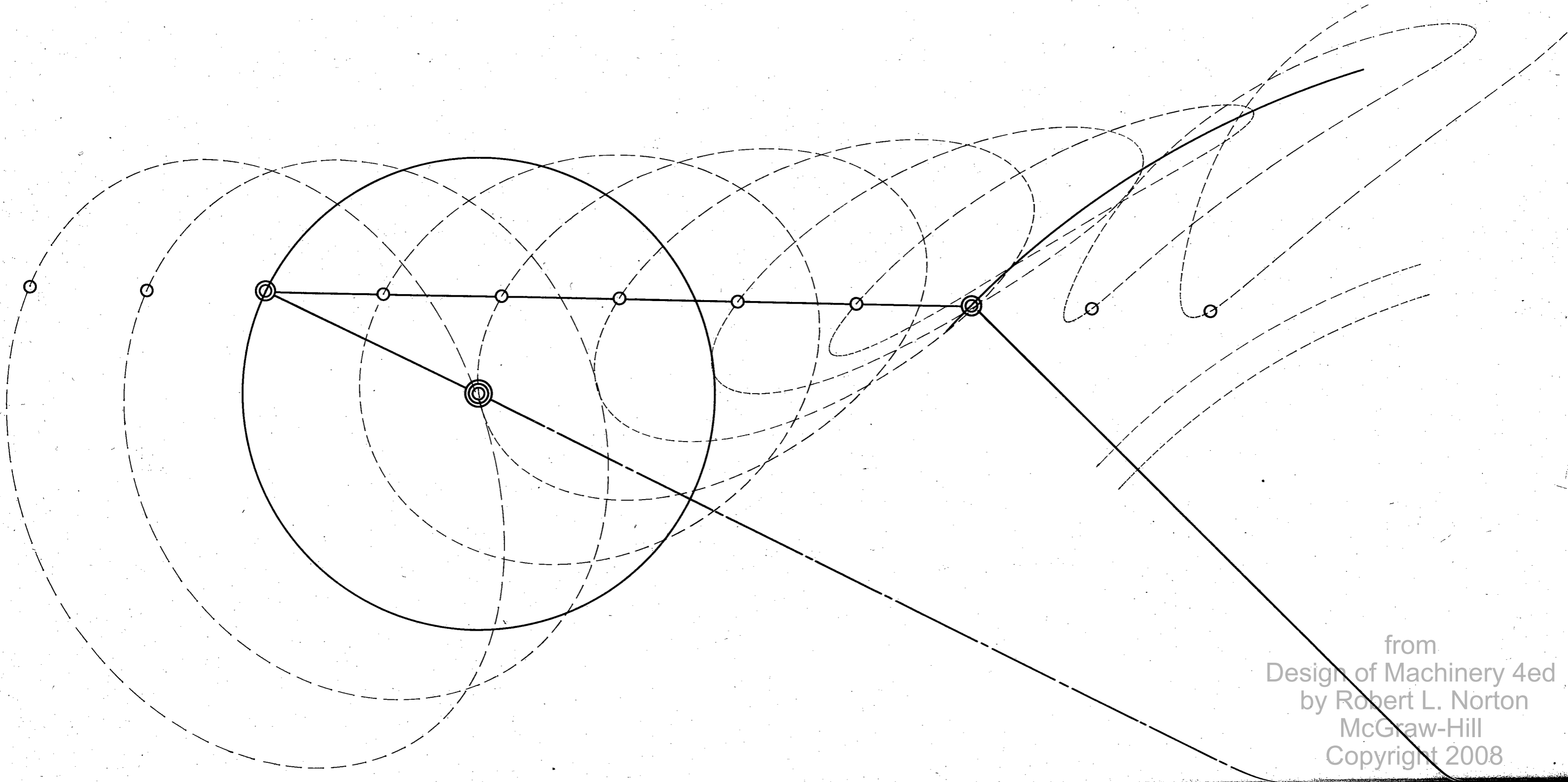
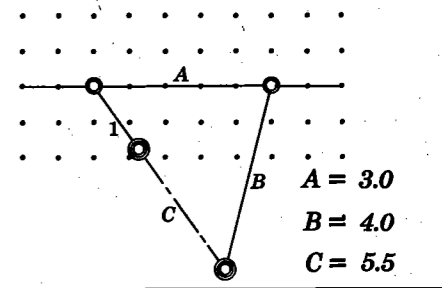

from  
Design of Machinery 4ed  
by Robert L. Norton  
McGraw-Hill  
Copyright 2008

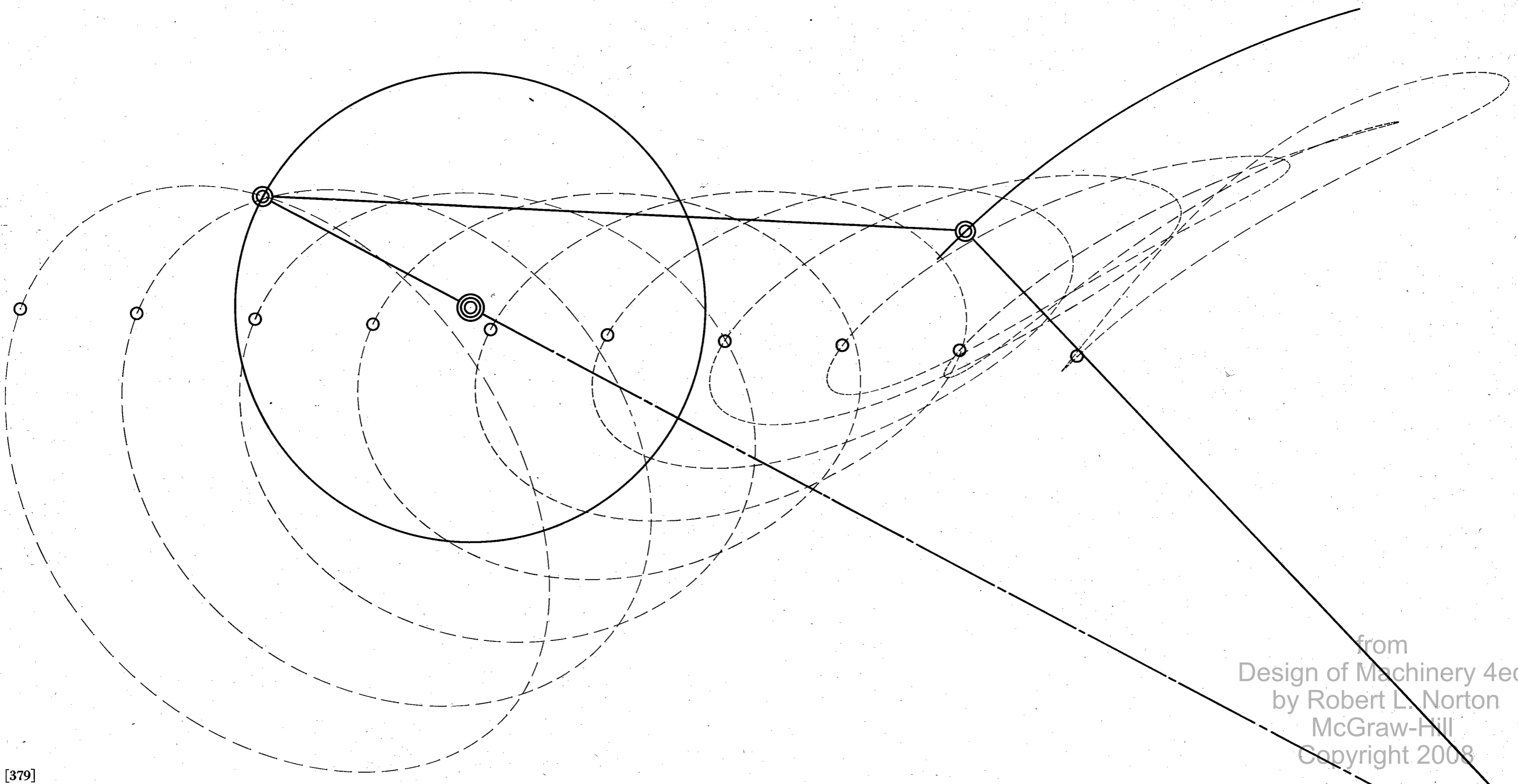
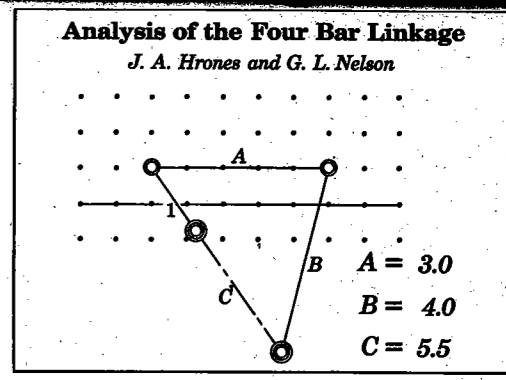

from  
 Design of Machinery 4ed  
 by Robert L. Norton  
 McGraw-Hill  
 Copyright 2008

**Analysis of the Four Bar Linkage**  
*J. A. Hrones and G. L. Nelson*

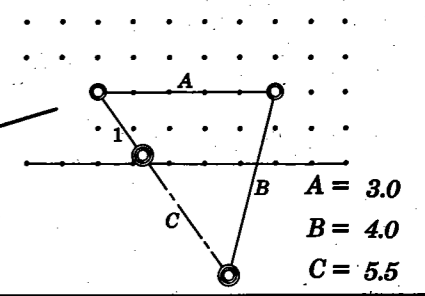

$A = 3.0$   
 $B = 4.0$   
 $C = 5.5$

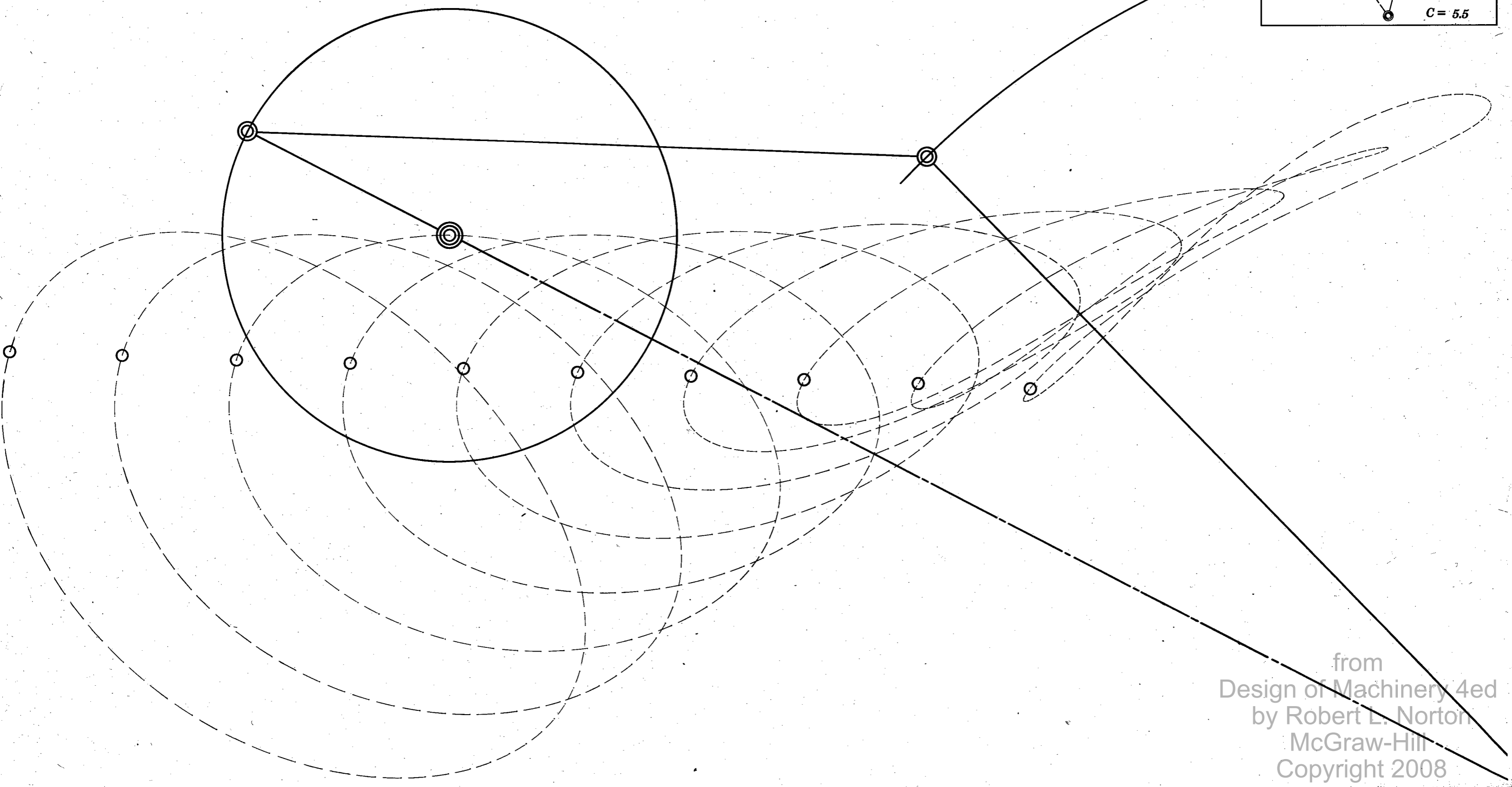

from  
Design of Machinery 4ed  
by Robert L. Norton  
McGraw-Hill  
Copyright 2008

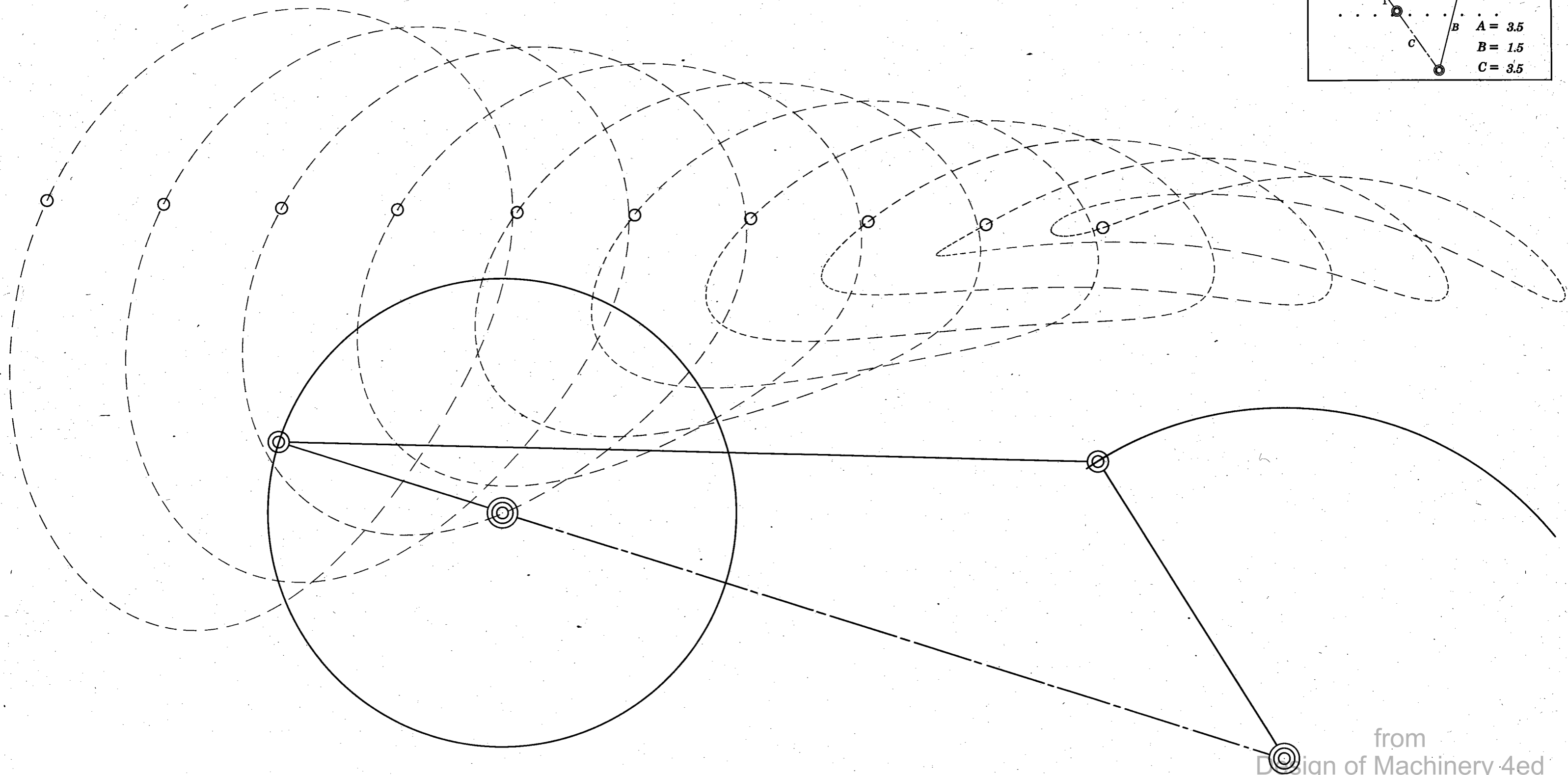
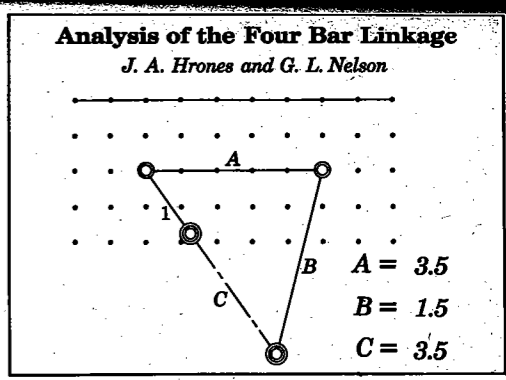

from  
 Design of Machinery 4ed  
 by Robert L. Norton  
 McGraw-Hill  
 Copyright 2008

**Analysis of the Four Bar Linkage**  
*J. A. Hrones and G. L. Nelson*

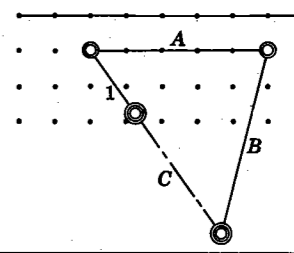

$A = 3.5$   
 $B = 1.5$   
 $C = 3.5$

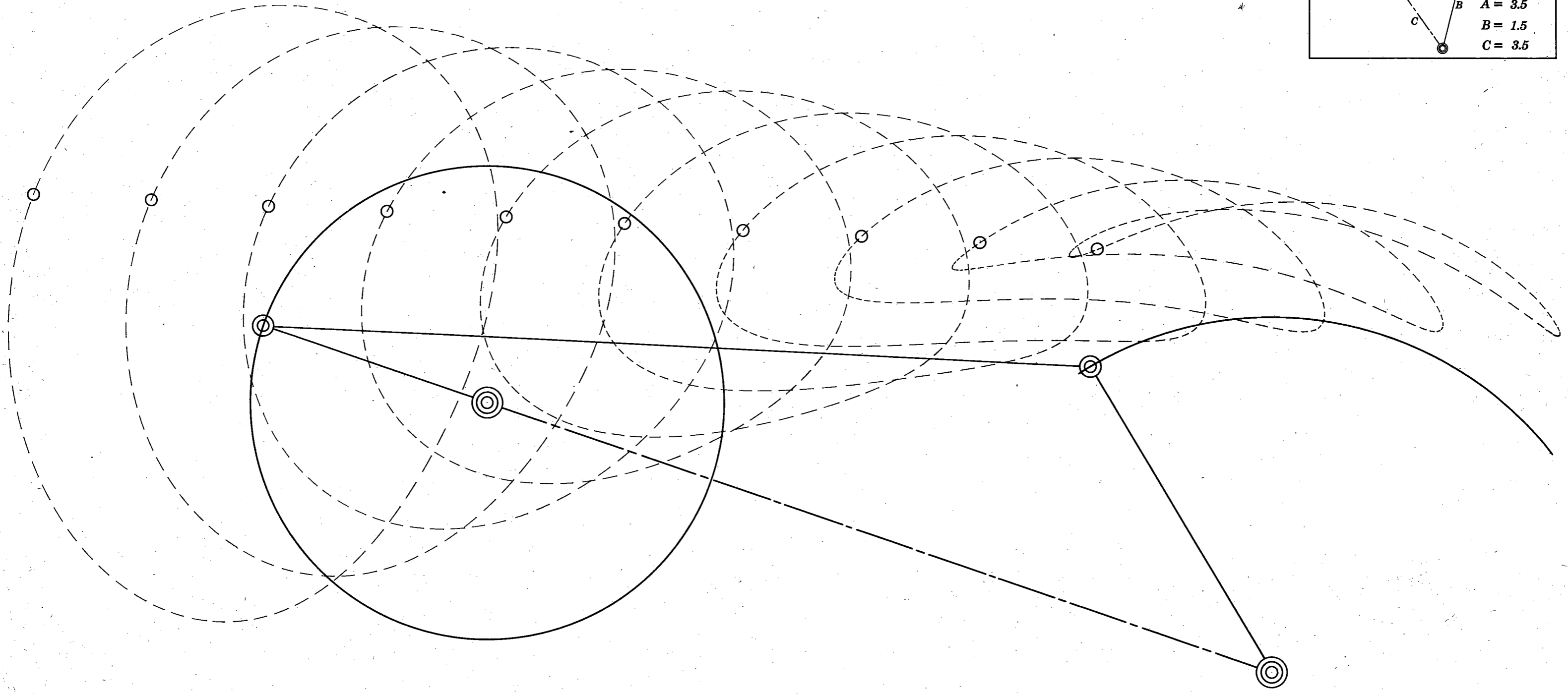

from  
Design of Machinery 4ed  
by Robert L. Norton  
McGraw-Hill  
Copyright 2008

**Analysis of the Four Bar Linkage**  
*J. A. Hrones and G. L. Nelson*

$A = 3.5$   
 $B = 1.5$   
 $C = 3.5$

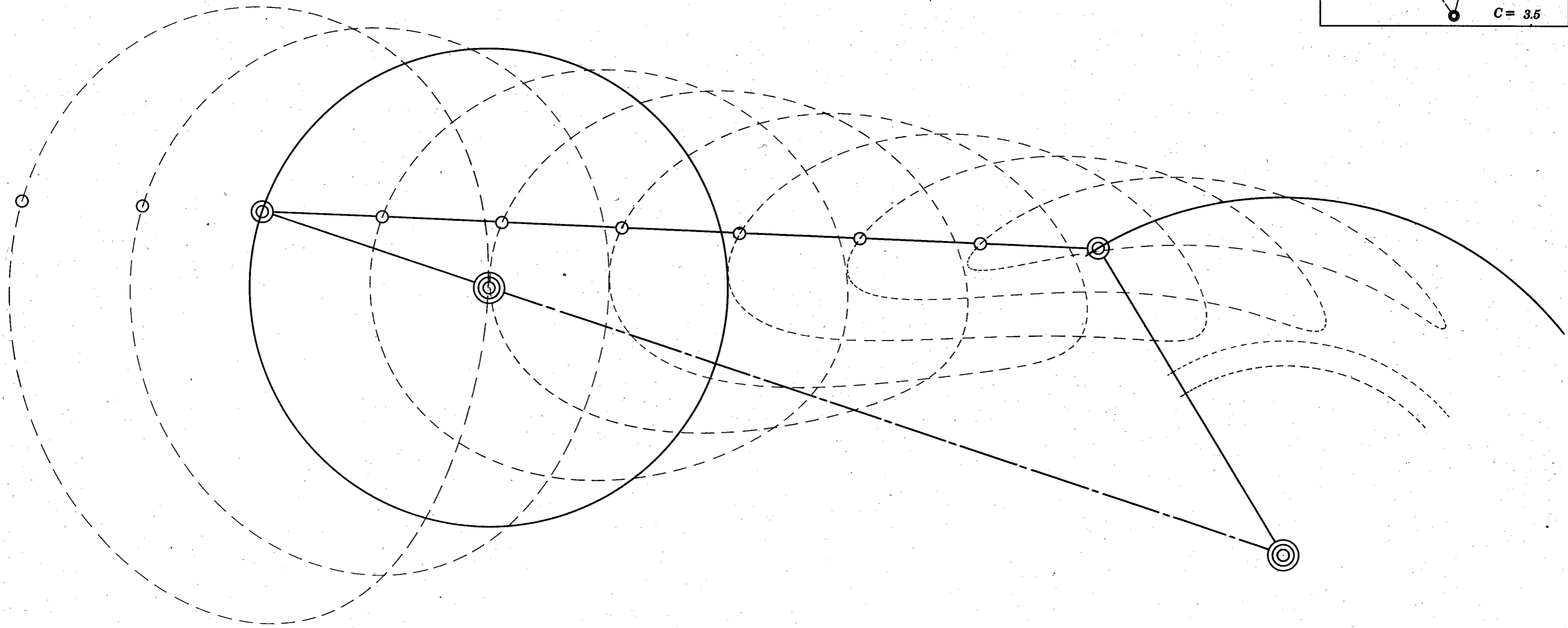

from  
 Design of Machinery 4ed  
 by Robert L. Norton  
 McGraw-Hill  
 Copyright 2008

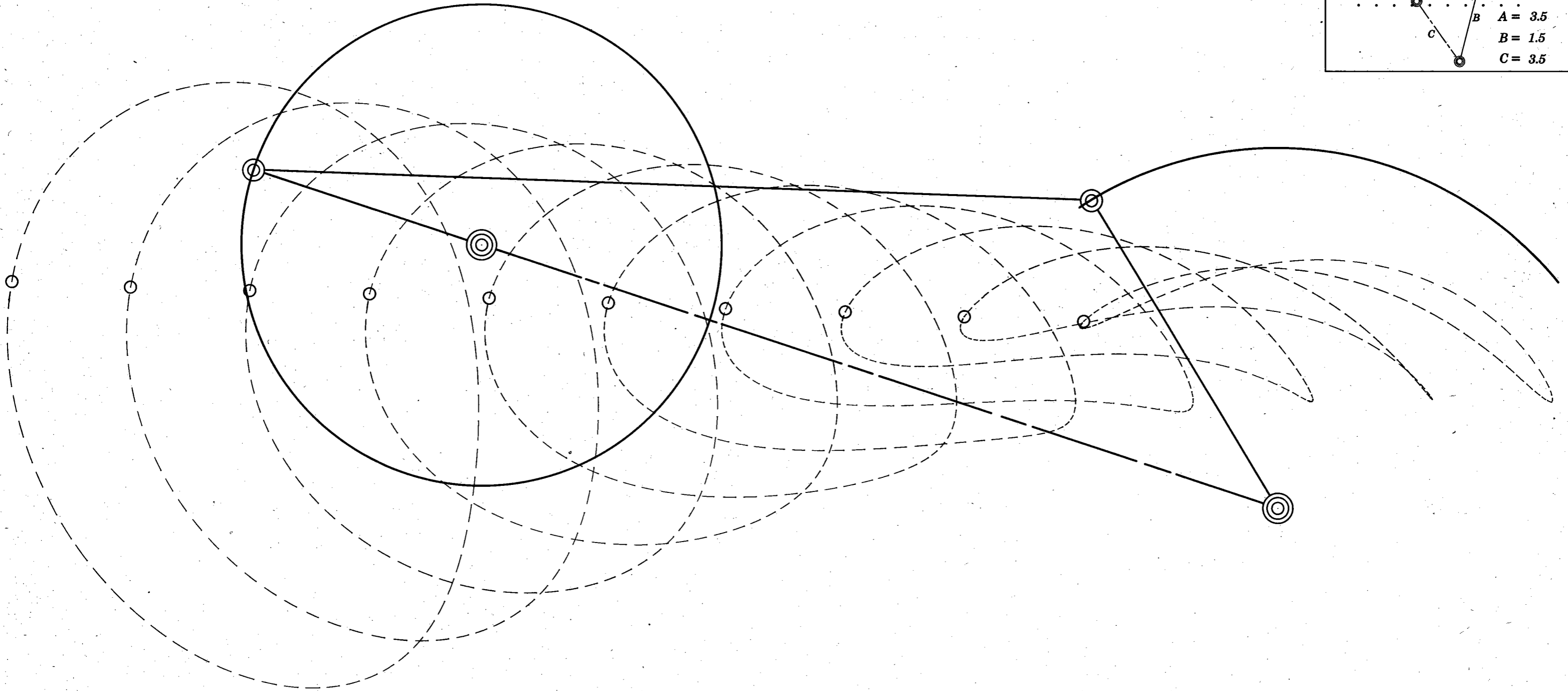
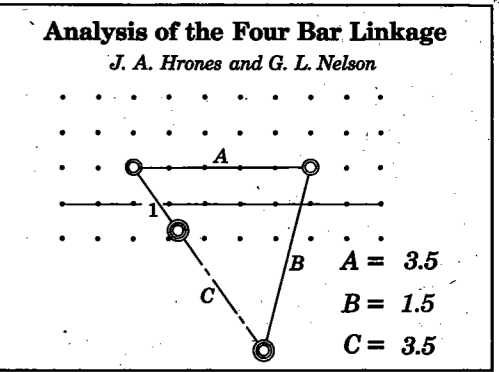

from  
Design of Machinery 4ed  
by Robert L. Norton  
McGraw-Hill  
Copyright 2008

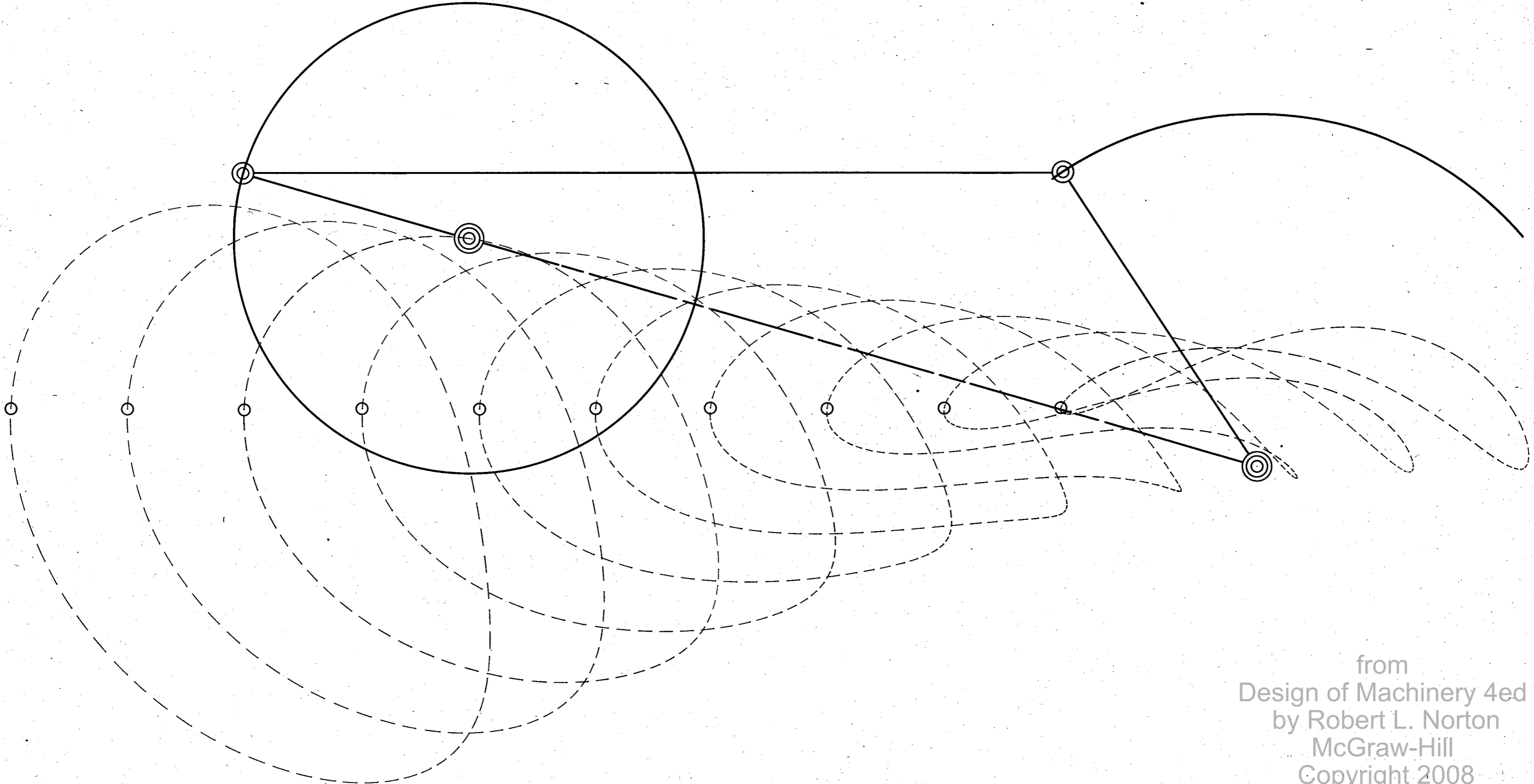
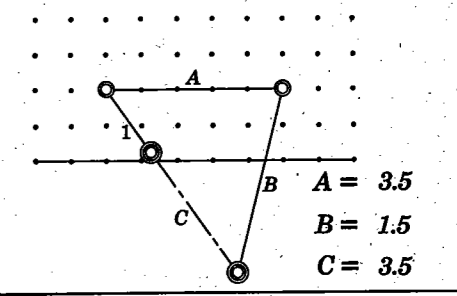

from  
Design of Machinery 4ed  
by Robert L. Norton  
McGraw-Hill  
Copyright 2008



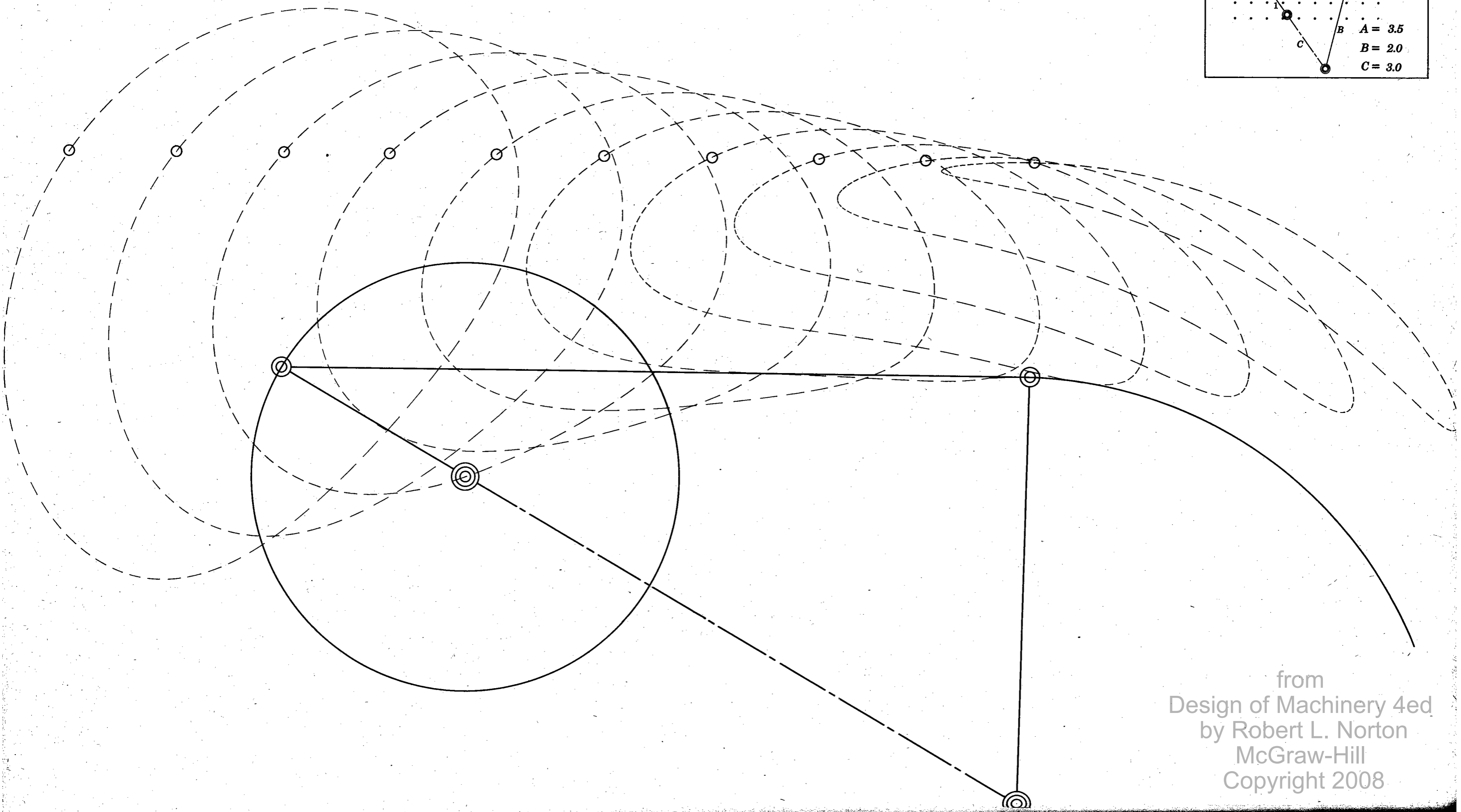
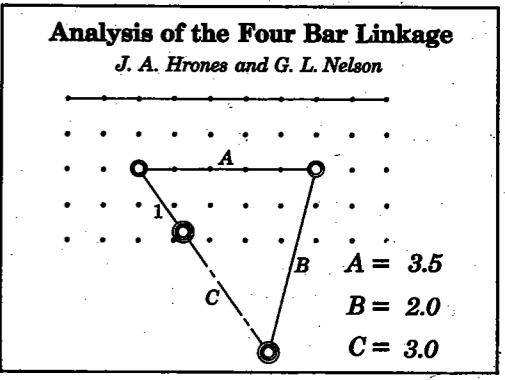

from  
Design of Machinery 4ed  
by Robert L. Norton  
McGraw-Hill  
Copyright 2008

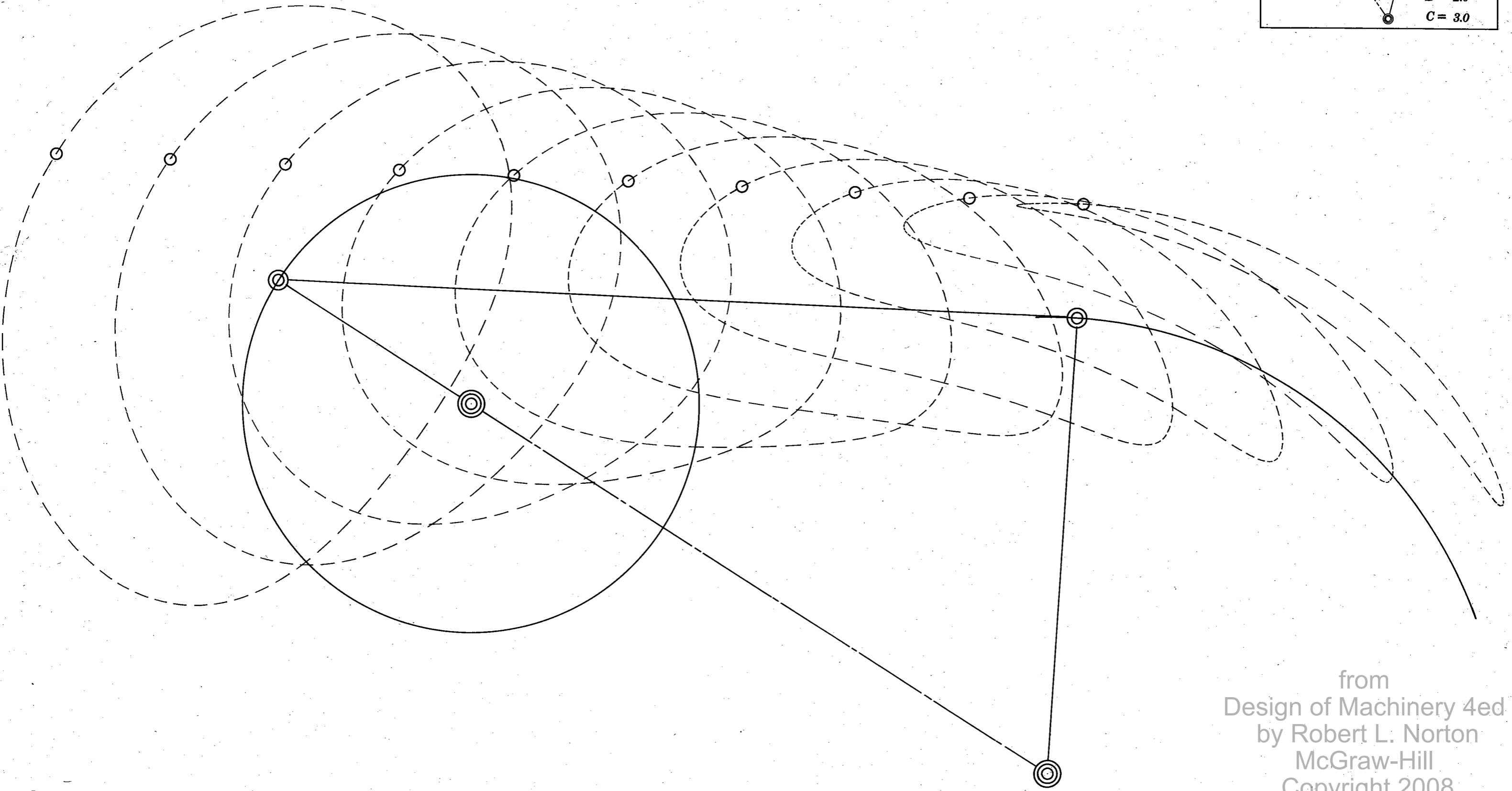
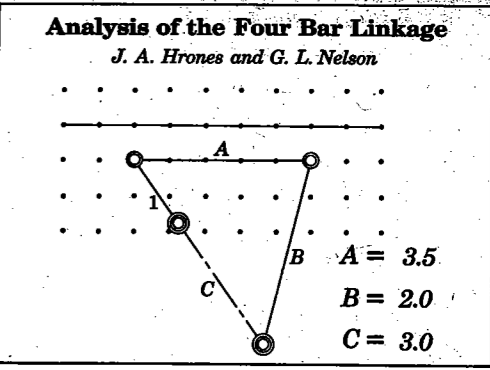

from  
 Design of Machinery 4ed  
 by Robert L. Norton  
 McGraw-Hill  
 Copyright 2008

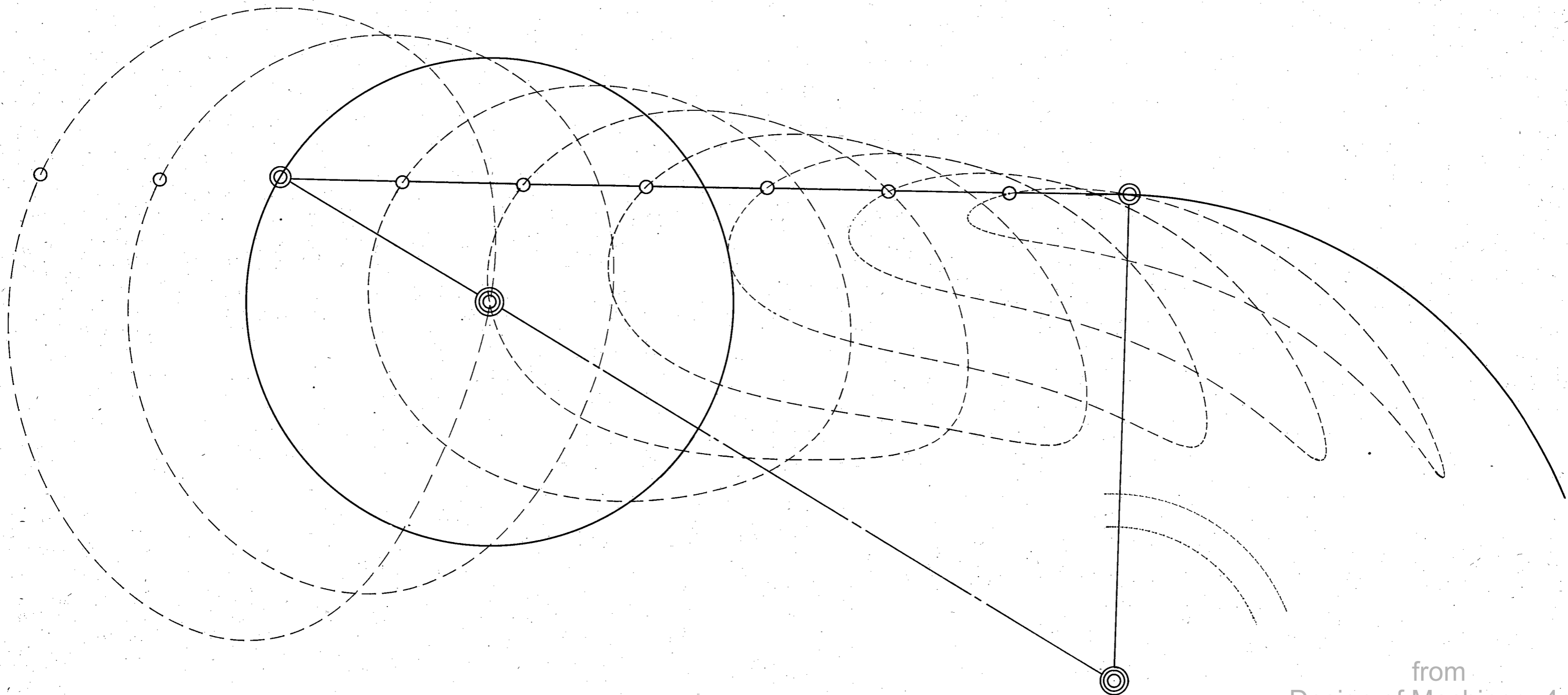
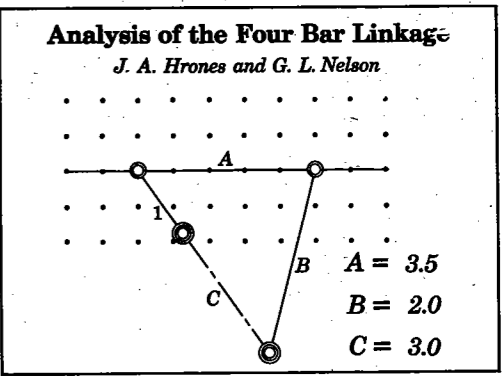

from  
Design of Machinery 4ed  
by Robert L. Norton  
McGraw-Hill  
Copyright 2008

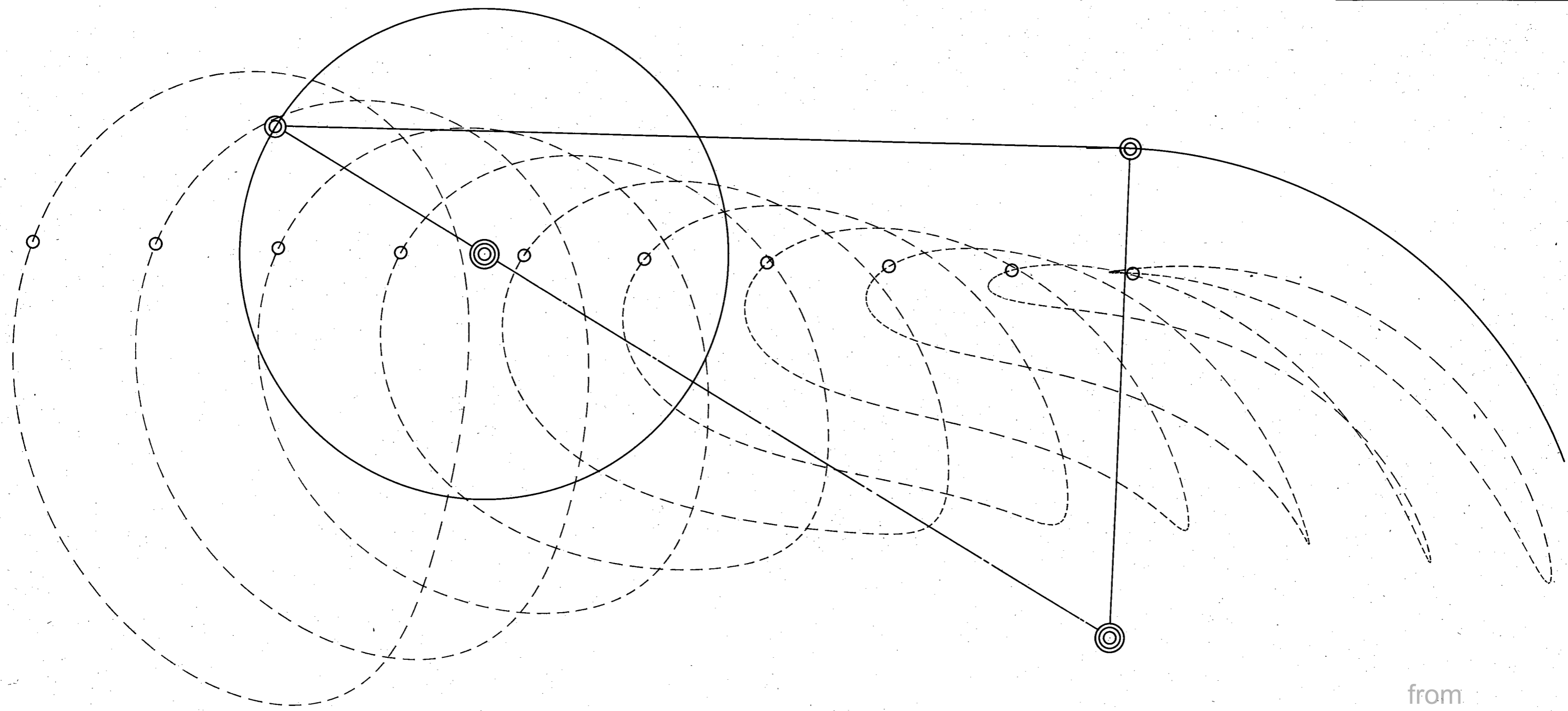
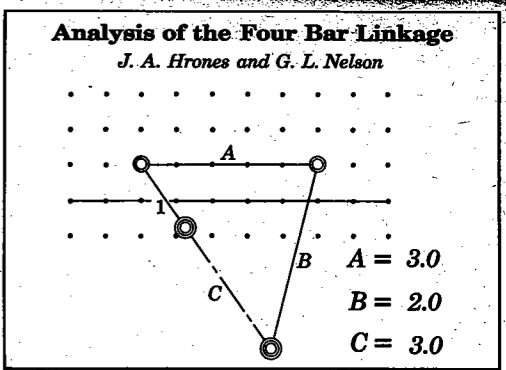

from  
 Design of Machinery 4ed  
 by Robert L. Norton  
 McGraw-Hill  
 Copyright 2008

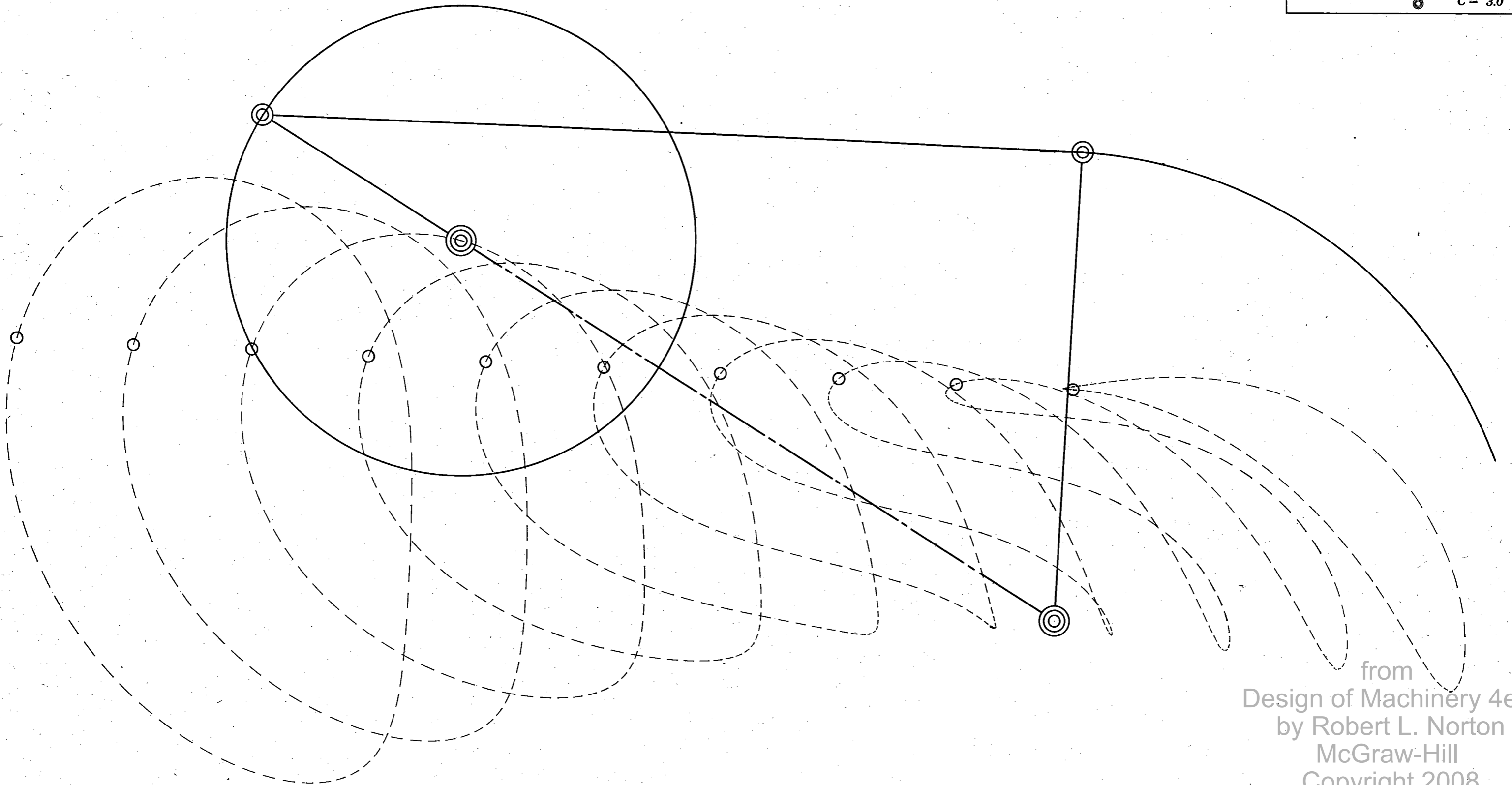
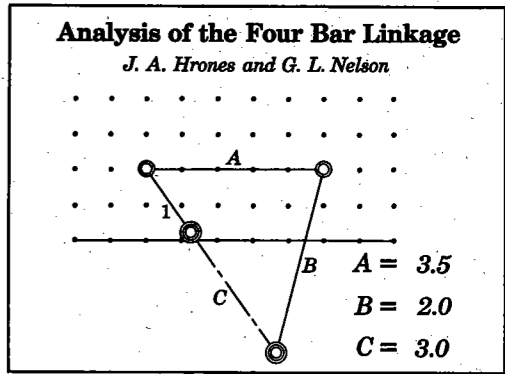

from  
Design of Machinery 4ed  
by Robert L. Norton  
McGraw-Hill  
Copyright 2008

**Analysis of the Four Bar Linkage**  
*J. A. Hrones and G. L. Nelson*

$A = 3.5$   
 $B = 2.0$   
 $C = 3.5$

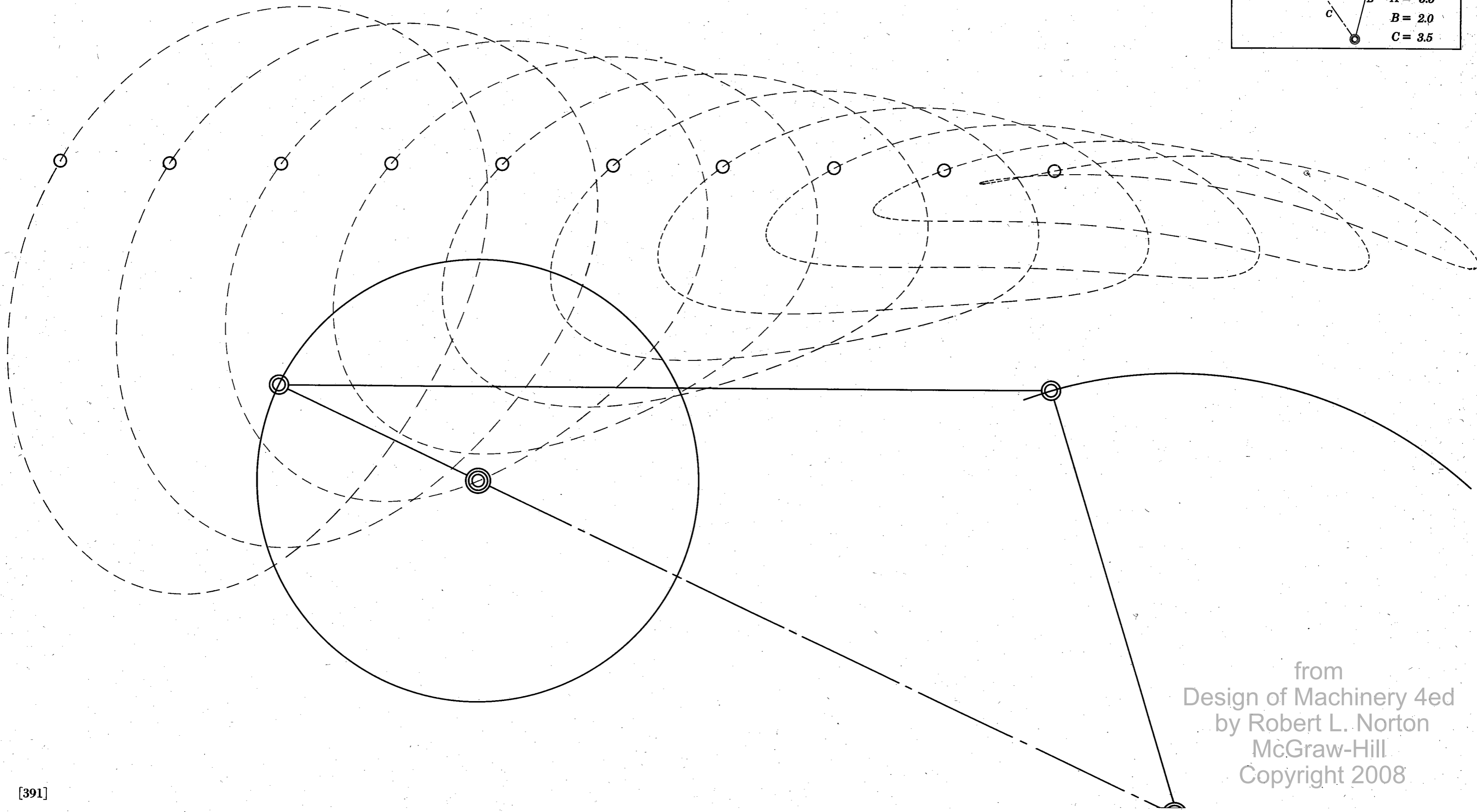

from  
Design of Machinery 4ed  
by Robert L. Norton  
McGraw-Hill  
Copyright 2008

**Analysis of the Four Bar Linkage**  
*J. A. Hrones and G. L. Nelson*

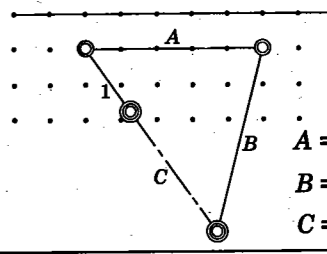

$A = 3.5$   
 $B = 2.0$   
 $C = 3.5$

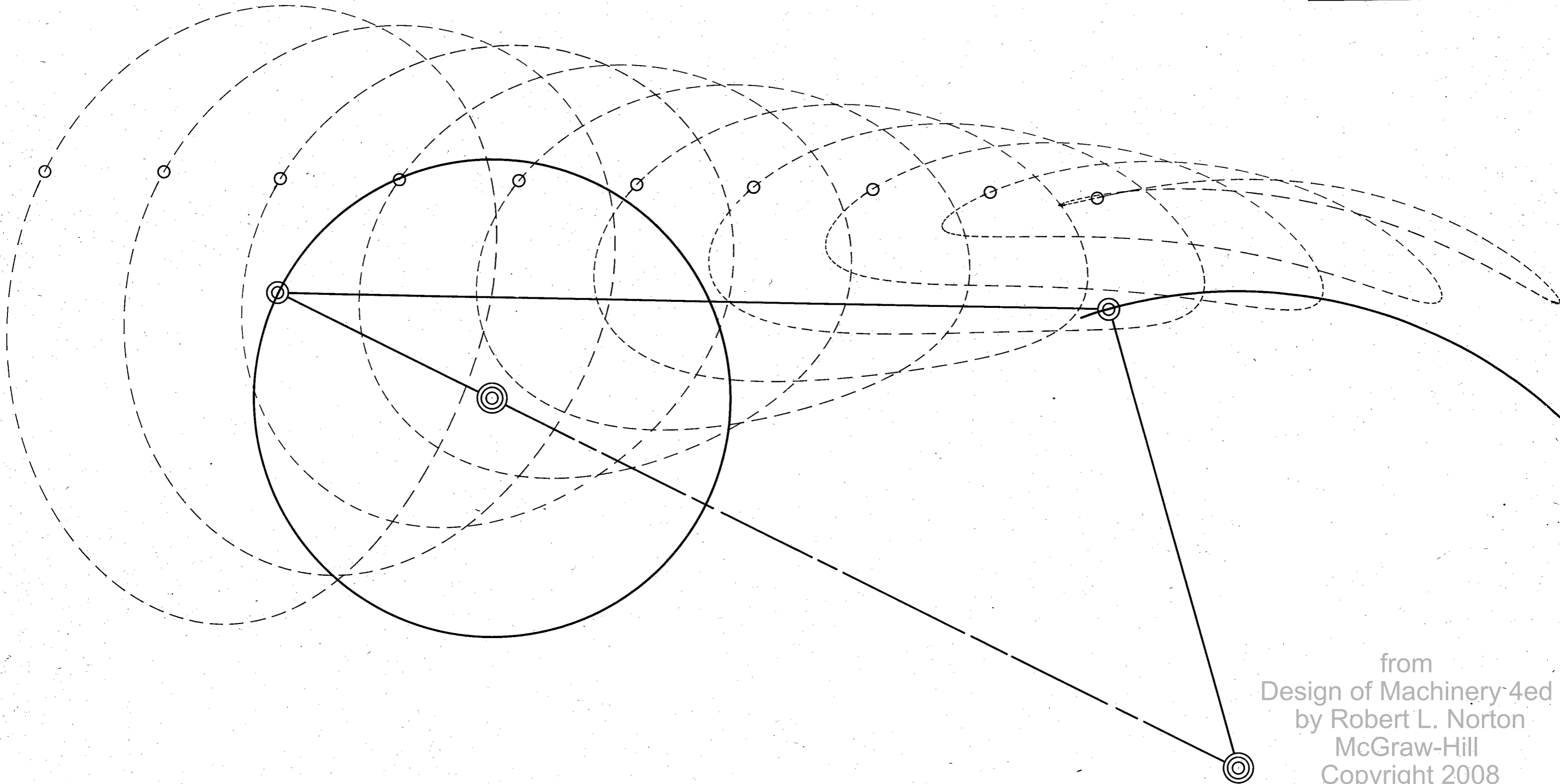

from  
Design of Machinery 4ed  
by Robert L. Norton  
McGraw-Hill  
Copyright 2008

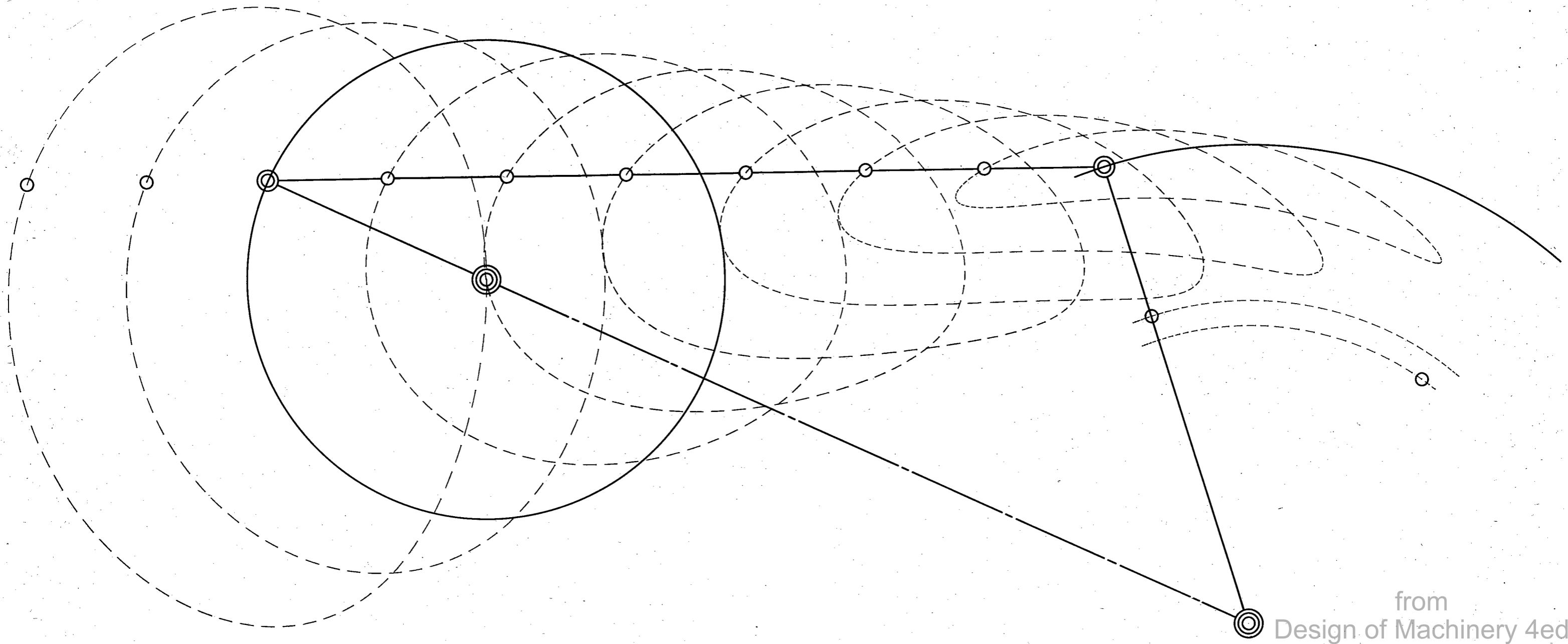
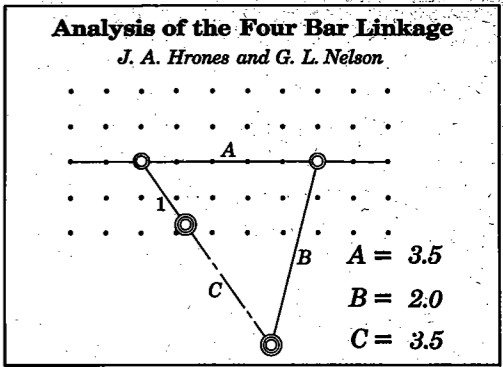

from  
 Design of Machinery 4ed  
 by Robert L. Norton  
 McGraw-Hill  
 Copyright 2008



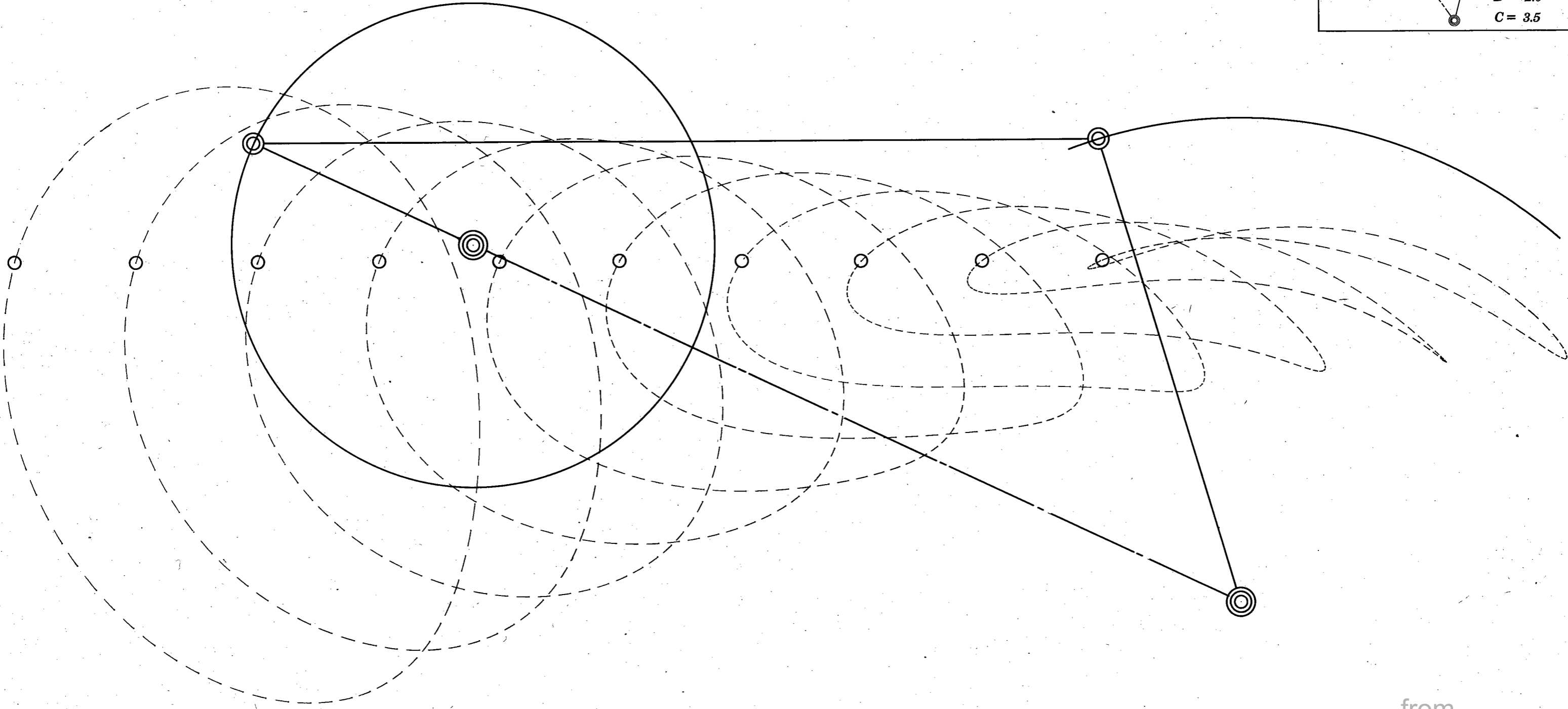
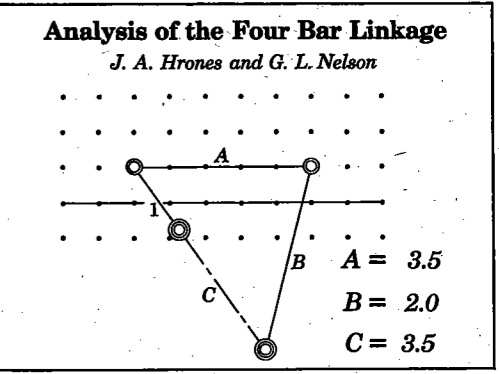

from  
Design of Machinery 4ed  
by Robert L. Norton  
McGraw-Hill  
Copyright 2008

**Analysis of the Four Bar Linkage**

*J. A. Hrones and G. L. Nelson*

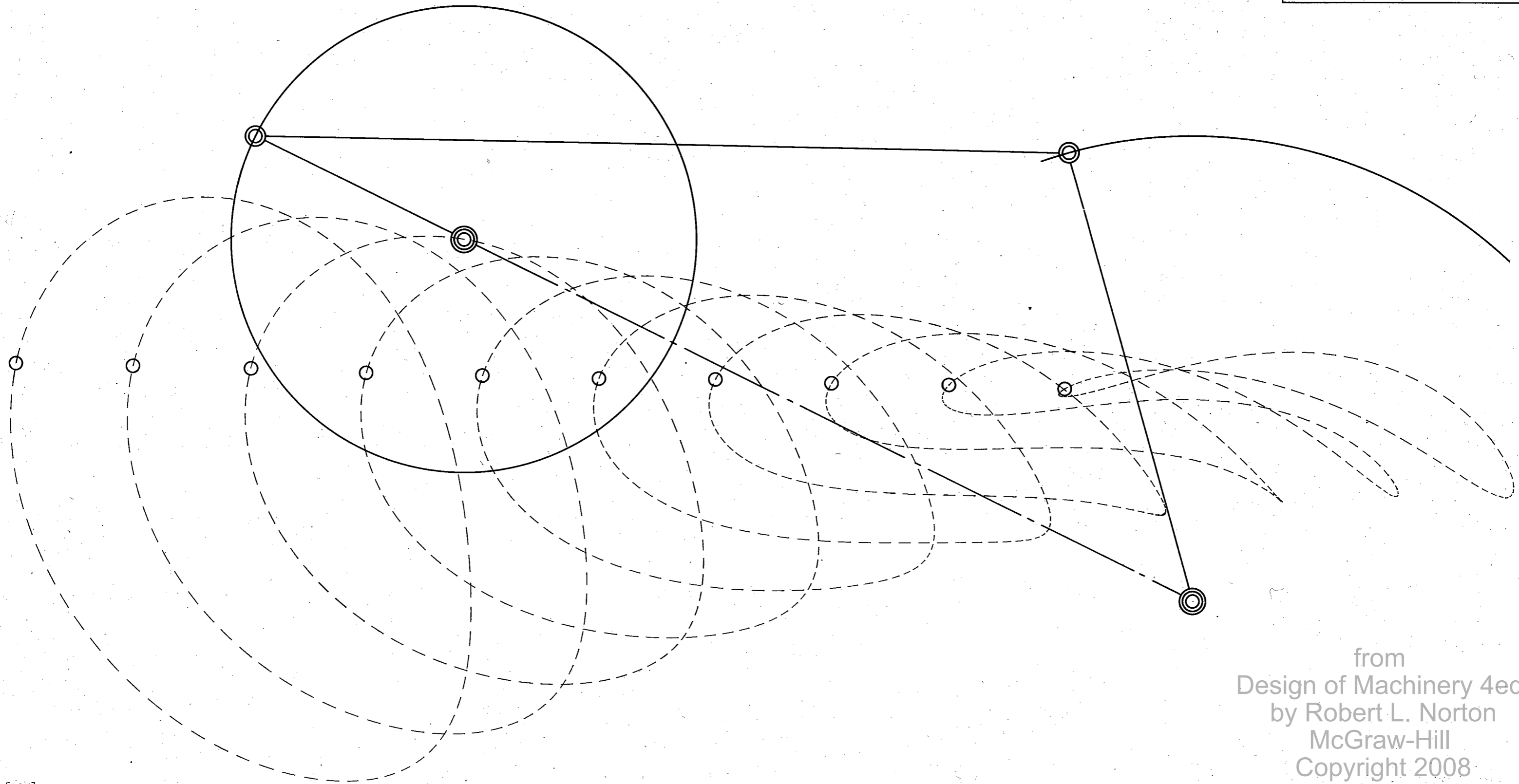
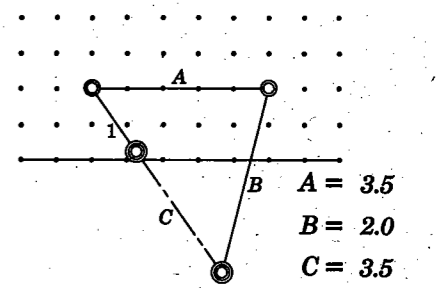

from  
Design of Machinery 4ed  
by Robert L. Norton  
McGraw-Hill  
Copyright 2008

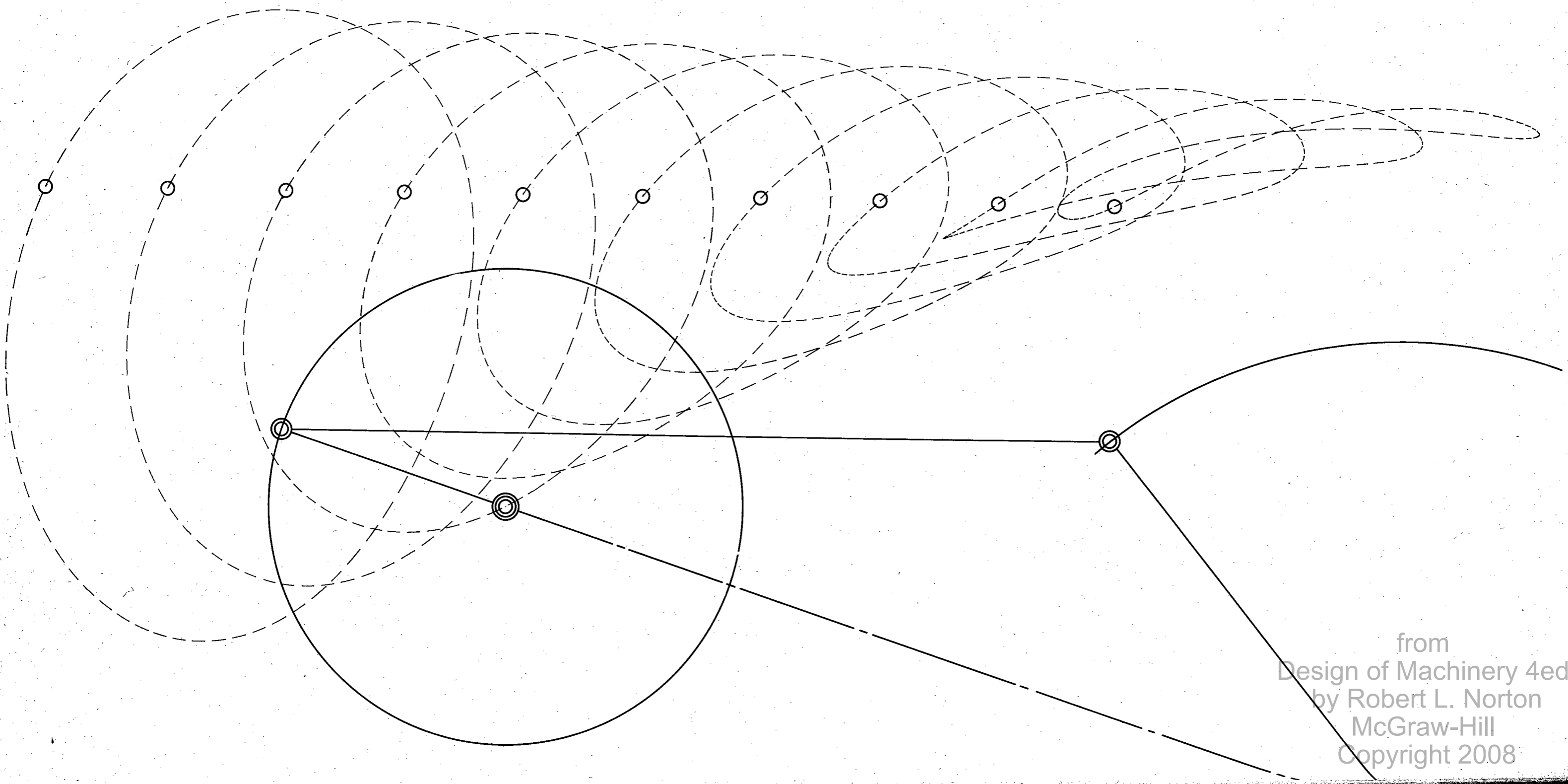
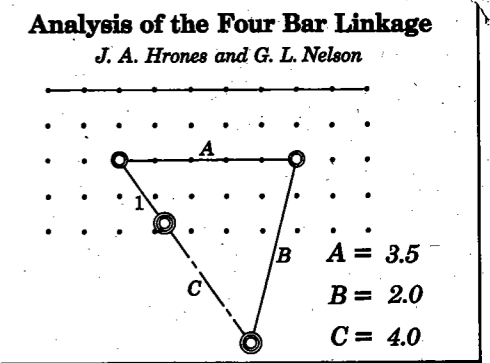

from  
Design of Machinery 4ed  
by Robert L. Norton  
McGraw-Hill  
Copyright 2008

**Analysis of the Four Bar Linkage**  
*J. A. Hrones and G. L. Nelson*

$A = 3.5$   
 $B = 2.0$   
 $C = 4.0$

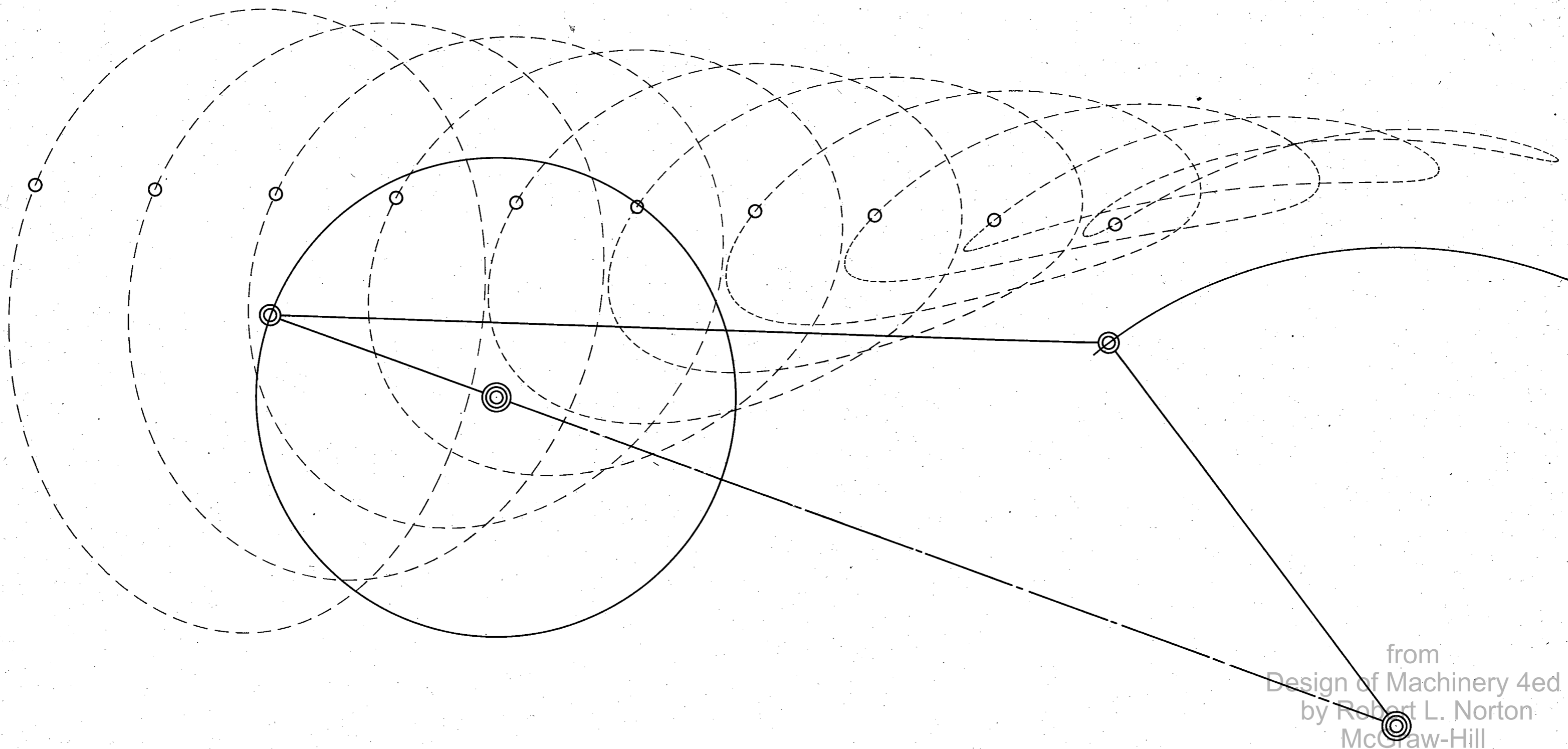

from  
 Design of Machinery 4ed  
 by Robert L. Norton  
 McGraw-Hill  
 Copyright 2008

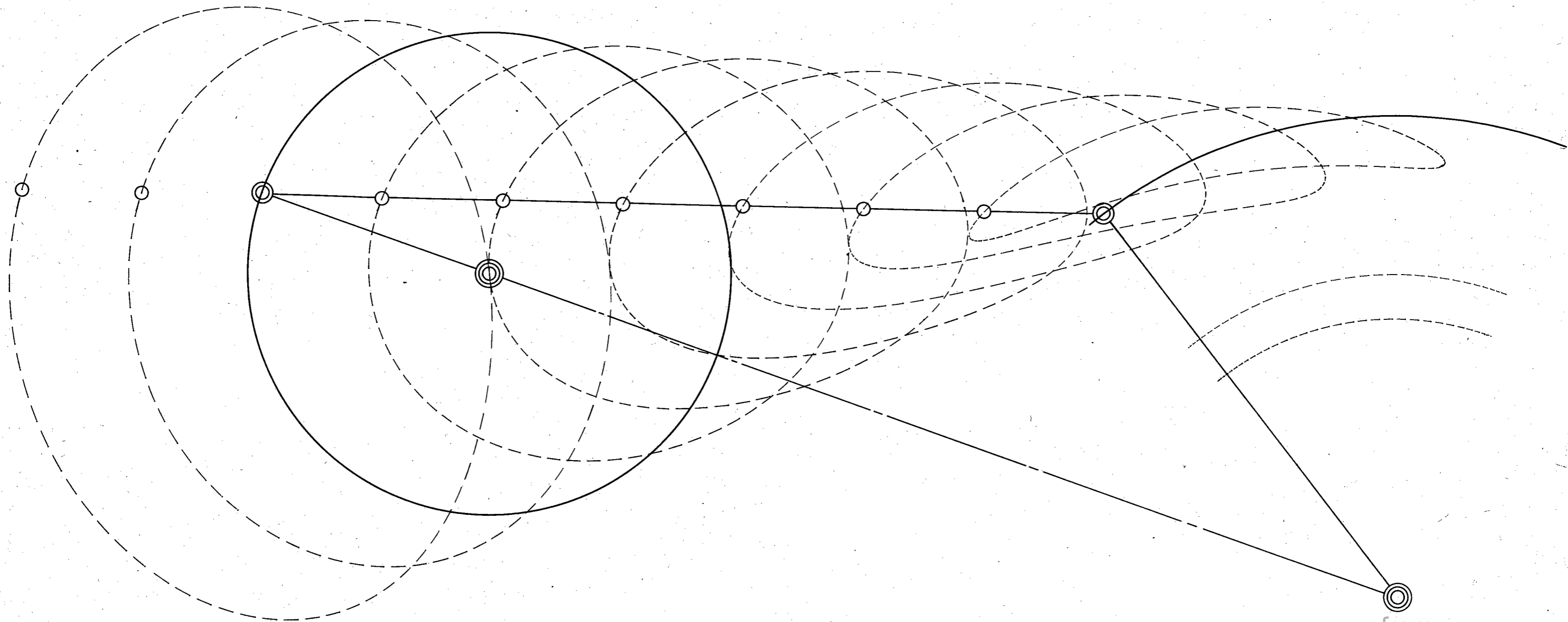
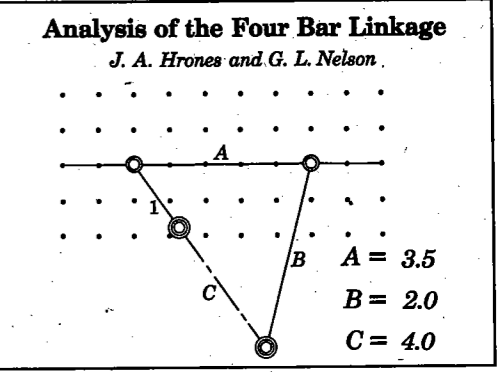

from

Design of Machinery 4ed  
by Robert L. Norton  
McGraw-Hill  
Copyright 2008

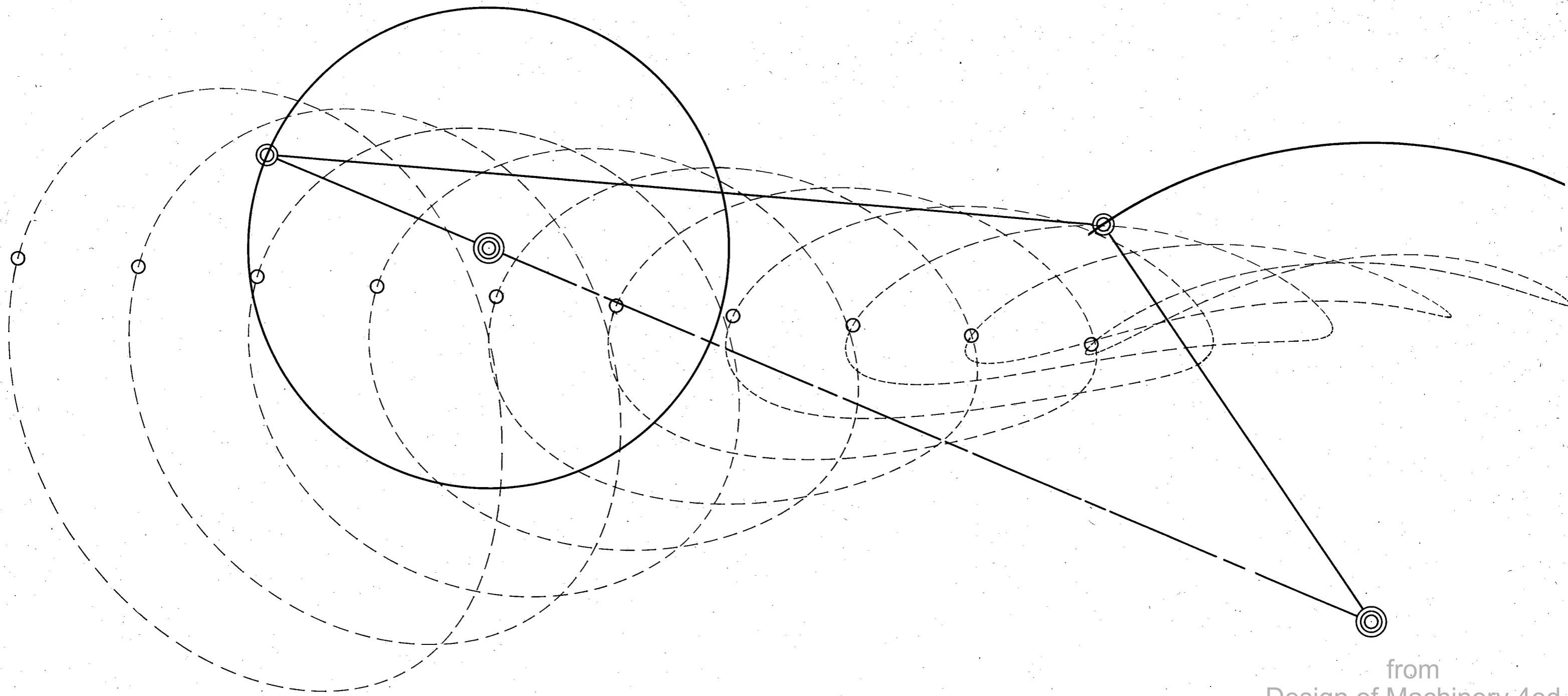
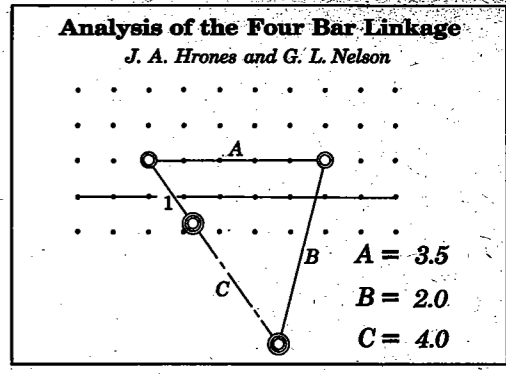

from  
 Design of Machinery 4ed  
 by Robert L. Norton  
 McGraw-Hill  
 Copyright 2008

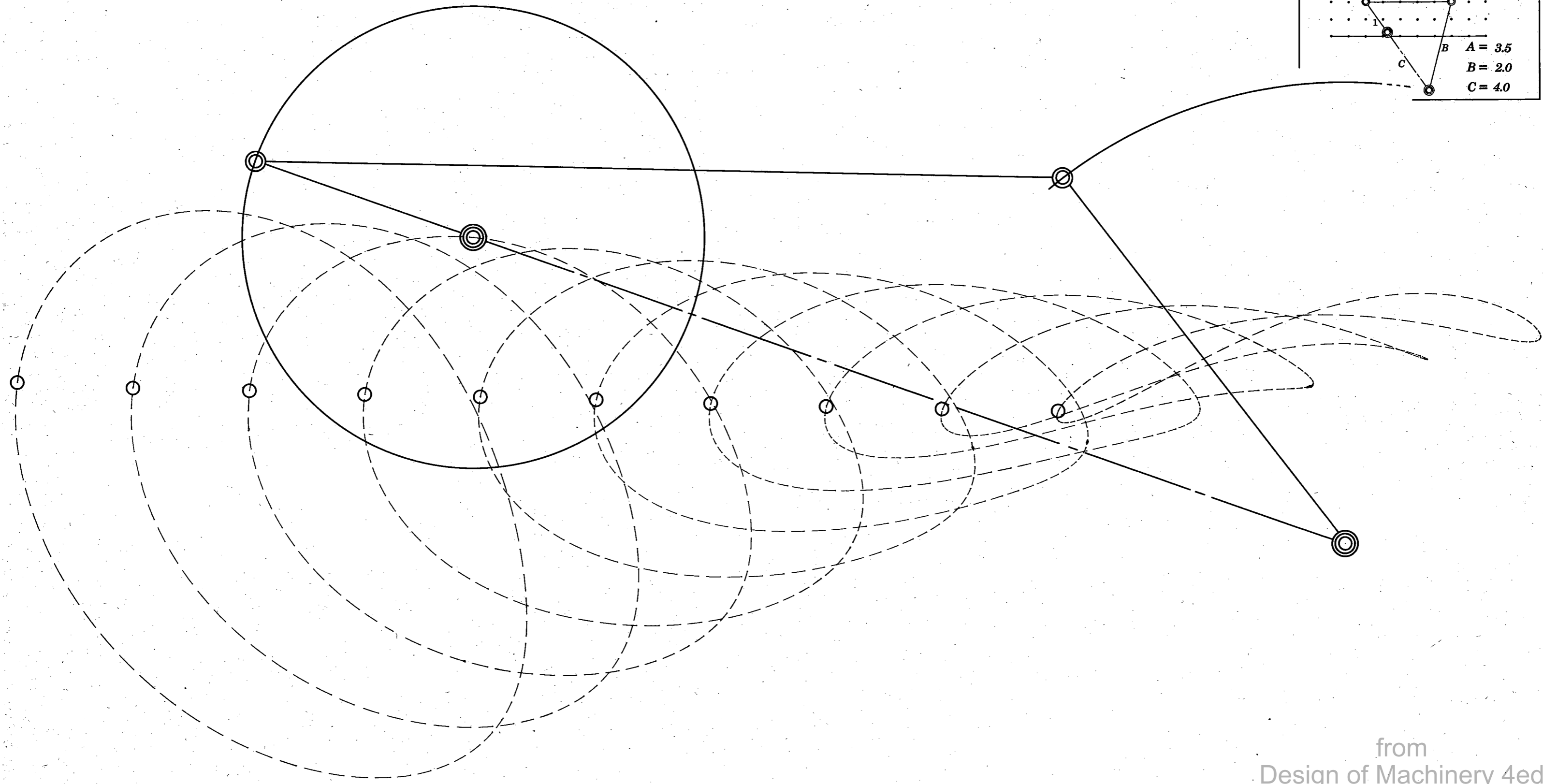
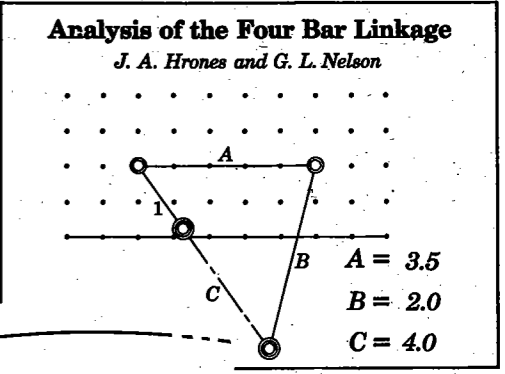

from  
Design of Machinery 4ed  
by Robert L. Norton  
McGraw-Hill  
Copyright 2008

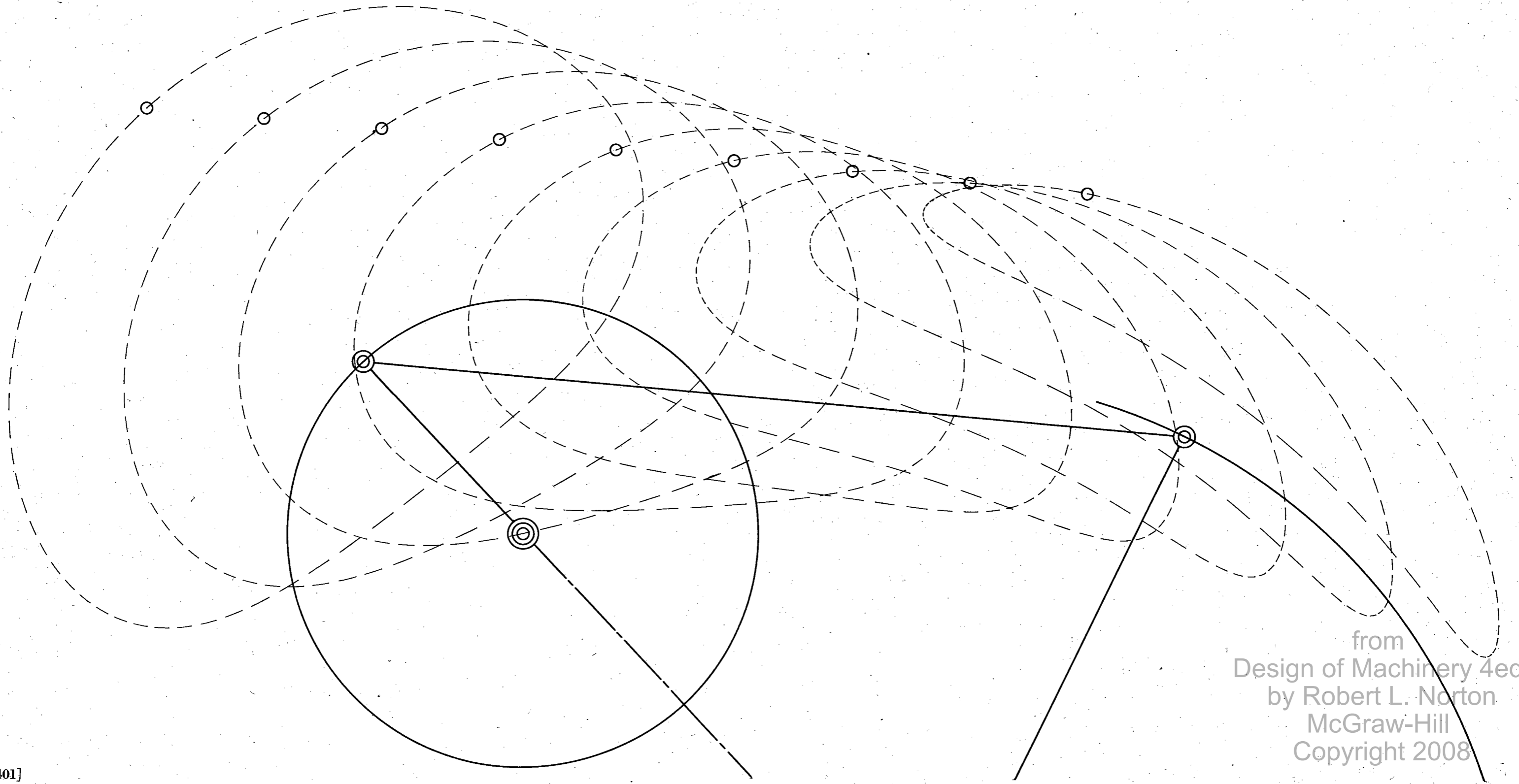
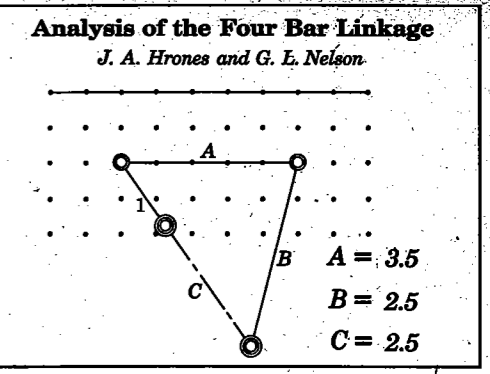

from  
Design of Machinery 4ed  
by Robert L. Norton  
McGraw-Hill  
Copyright 2008



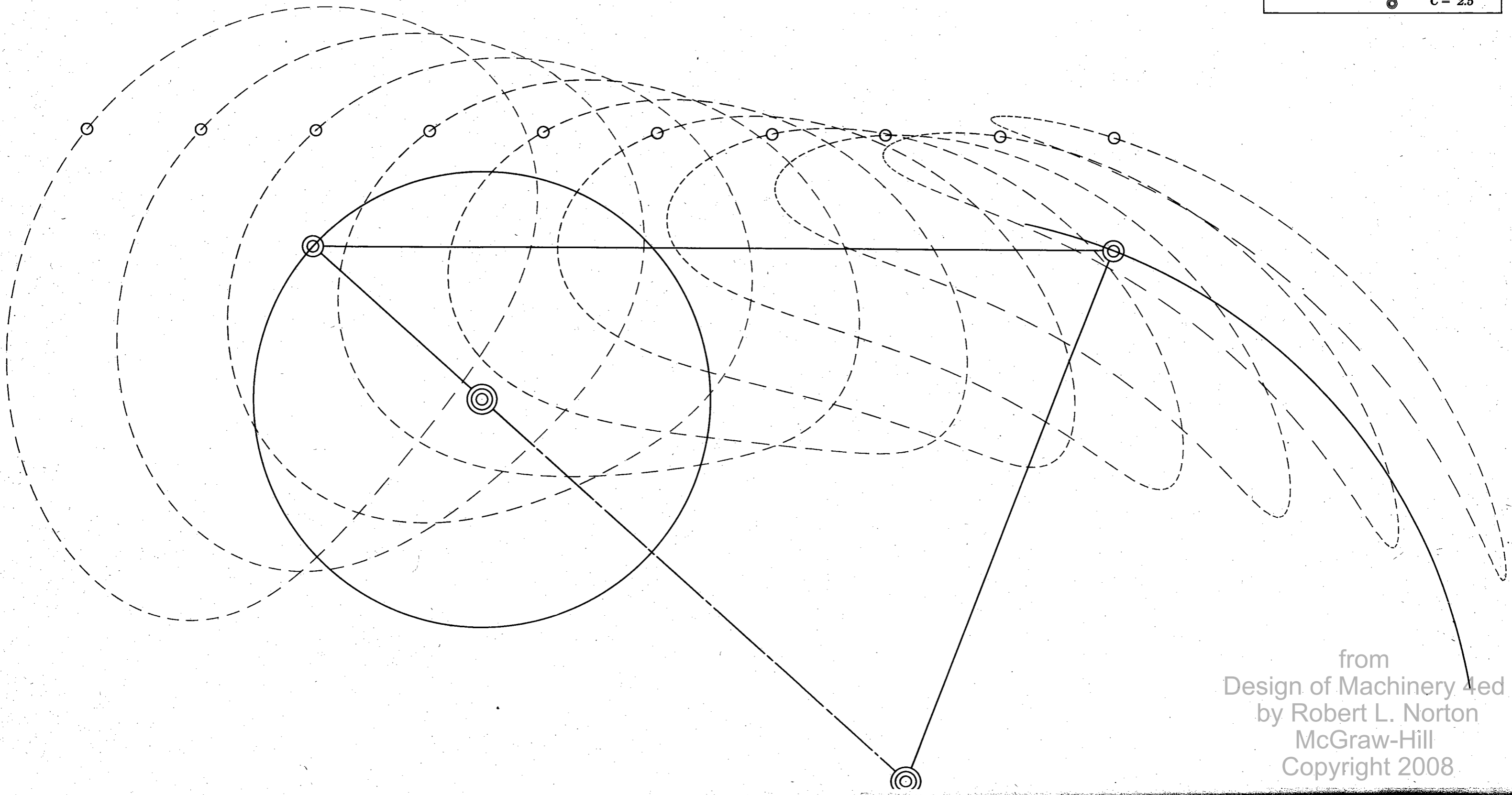
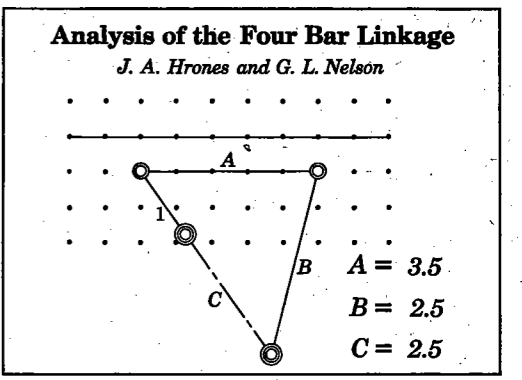

from  
Design of Machinery 4ed  
by Robert L. Norton  
McGraw-Hill  
Copyright 2008

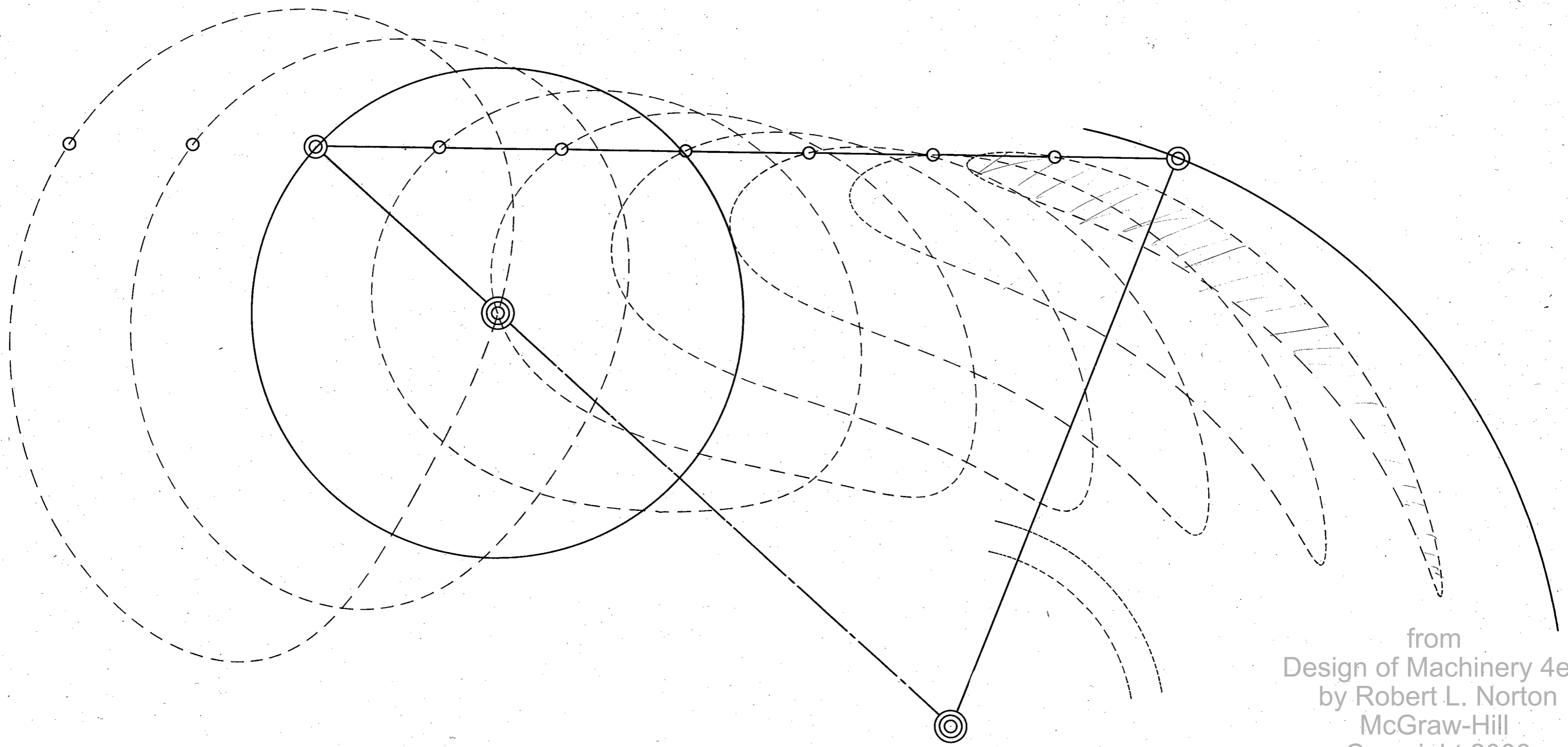
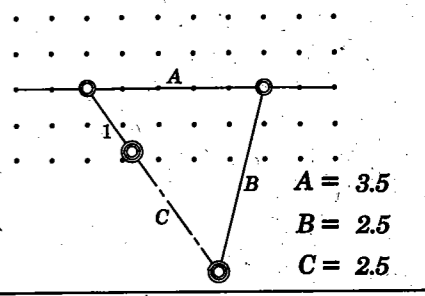

from  
Design of Machinery 4ed  
by Robert L. Norton  
McGraw-Hill  
Copyright 2008

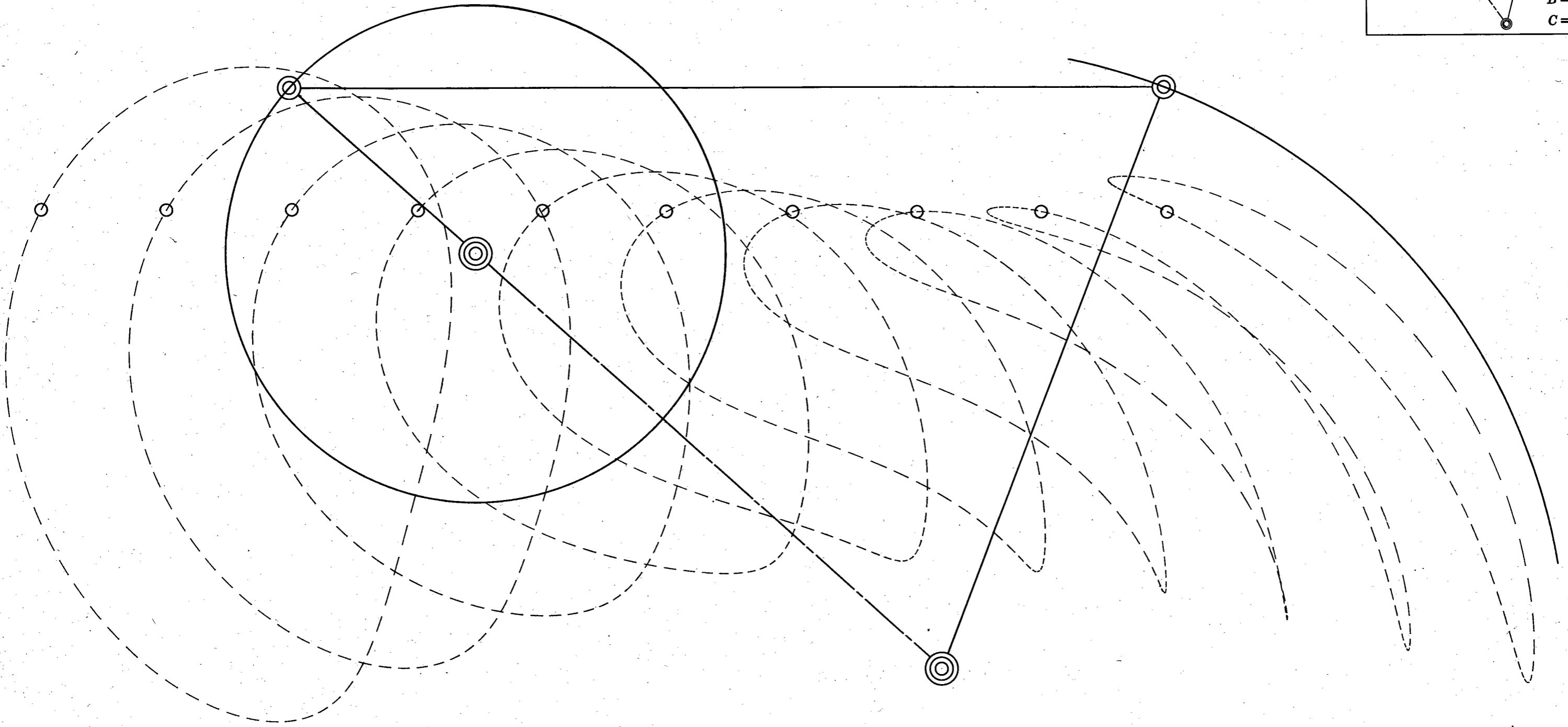
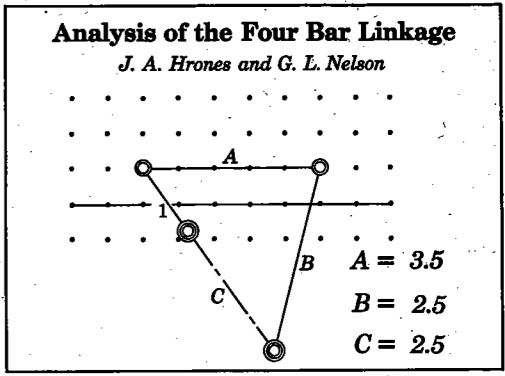

from  
Design of Machinery 4ed  
by Robert L. Norton  
McGraw-Hill  
Copyright 2008

Analysis of the Four Bar Linkage

J. A. Hrones and G. L. Nelson

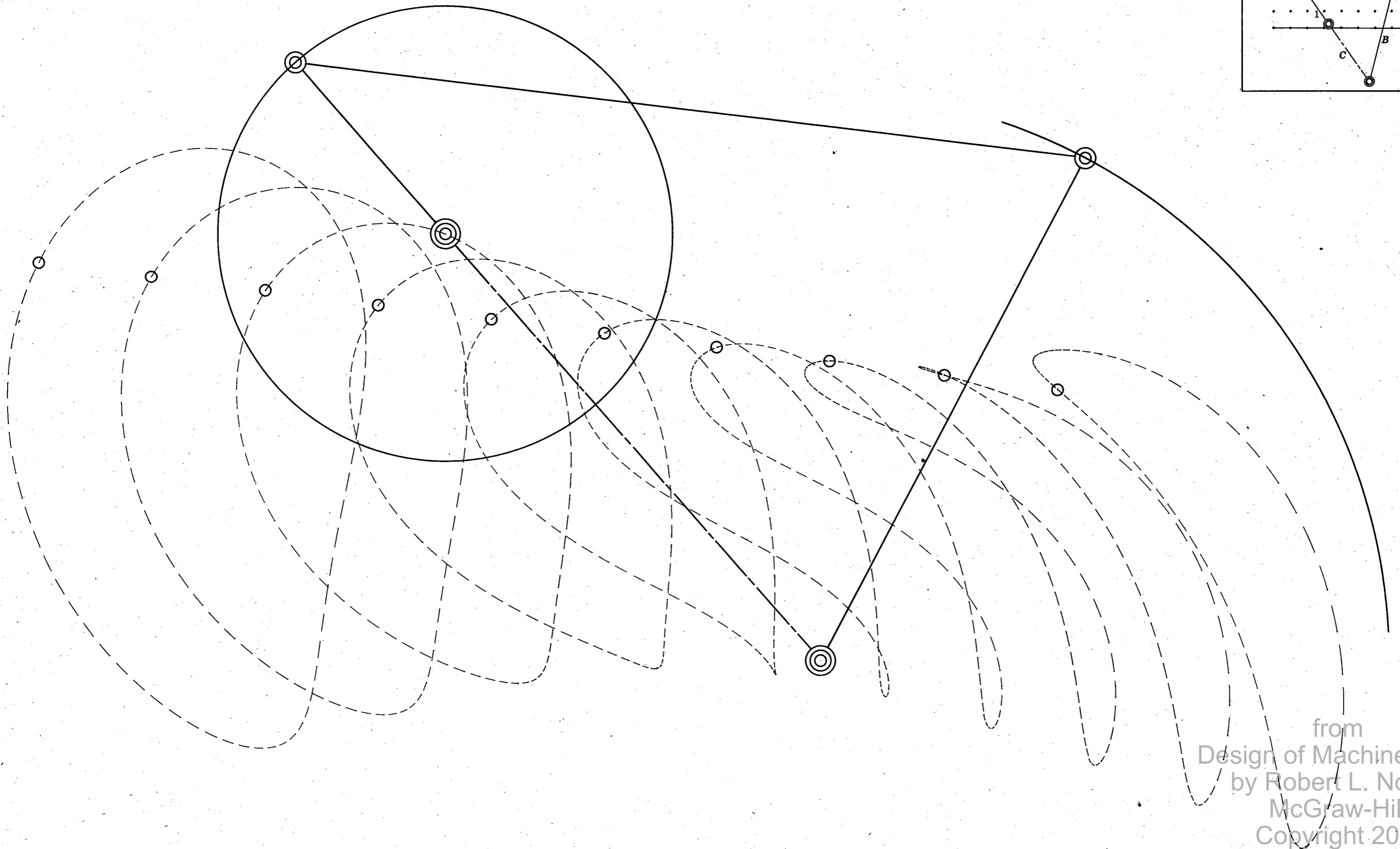
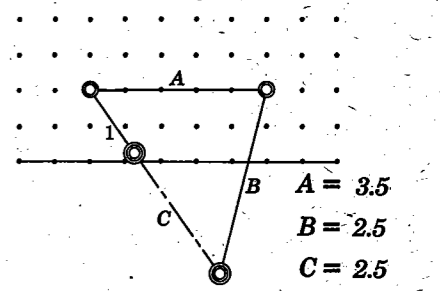

from  
Design of Machinery 4ed  
by Robert L. Norton  
McGraw-Hill  
Copyright 2008

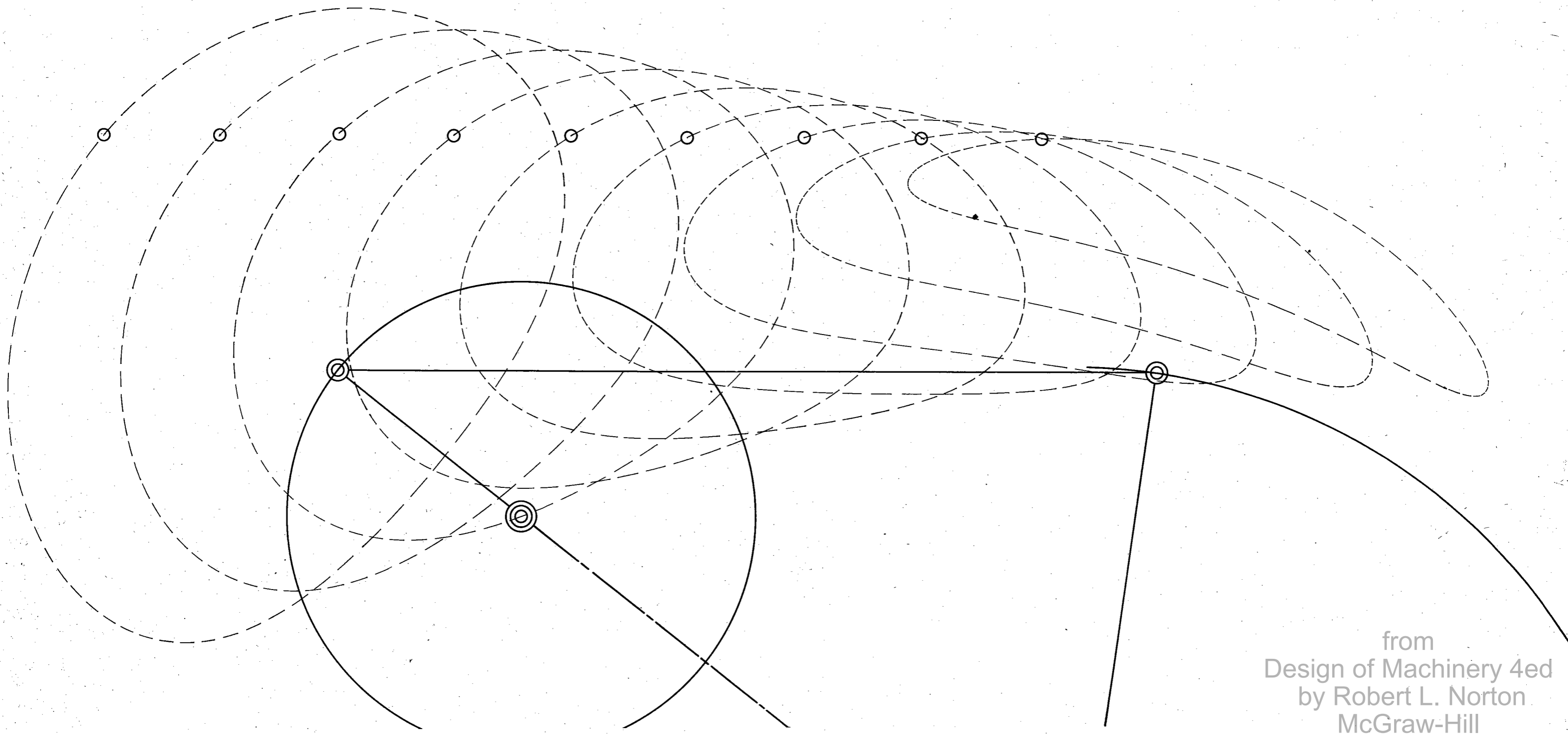
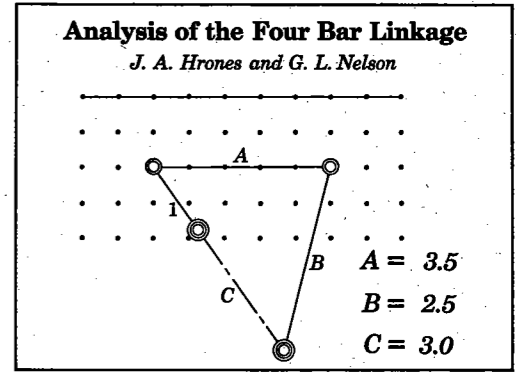

from  
Design of Machinery 4ed  
by Robert L. Norton  
McGraw-Hill  
Copyright 2008

**Analysis of the Four Bar Linkage**  
*J. A. Hrones and G. L. Nelson*

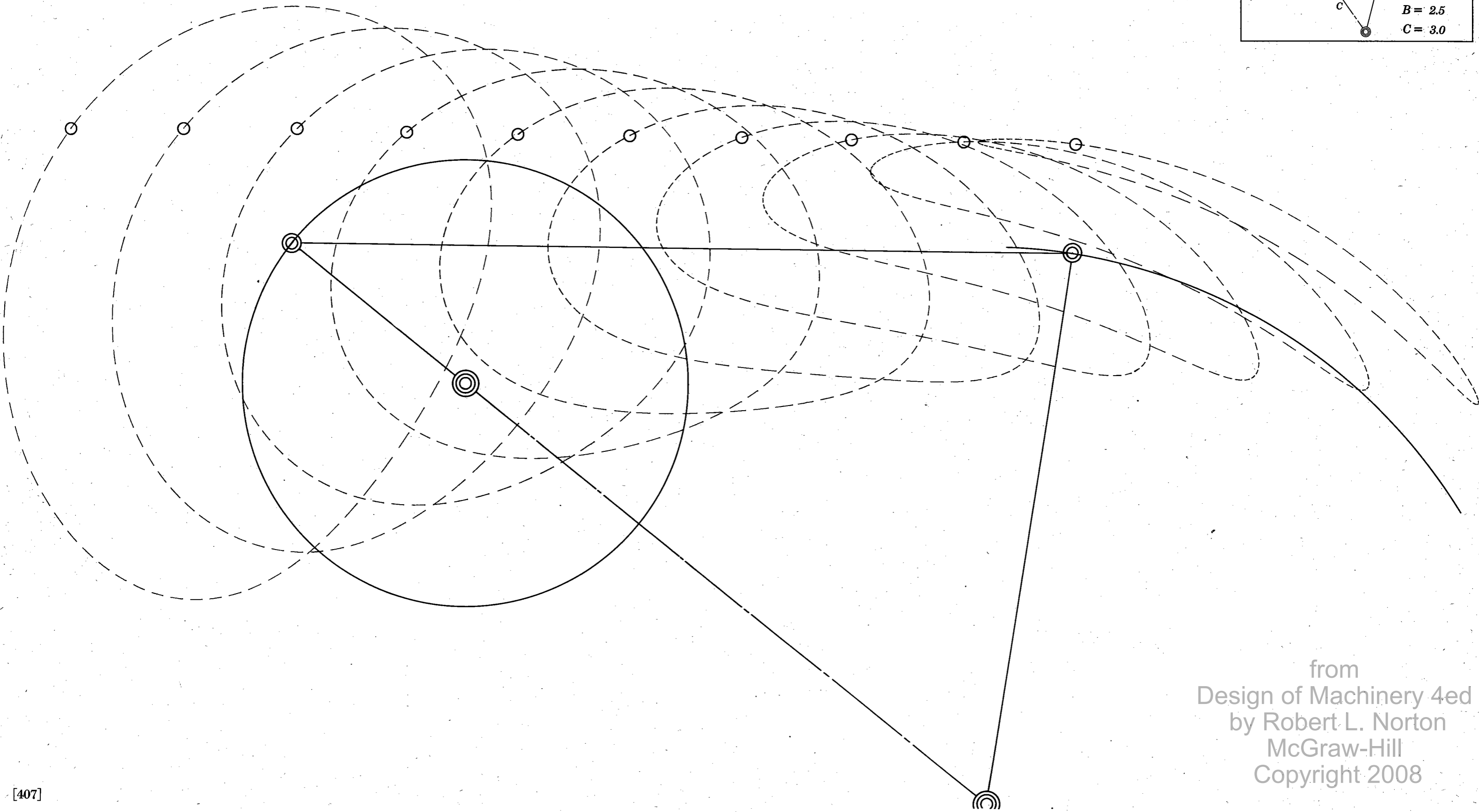
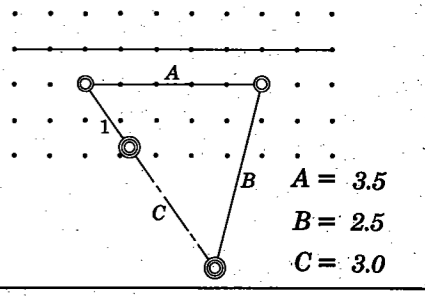

from  
Design of Machinery 4ed  
by Robert L. Norton  
McGraw-Hill  
Copyright 2008

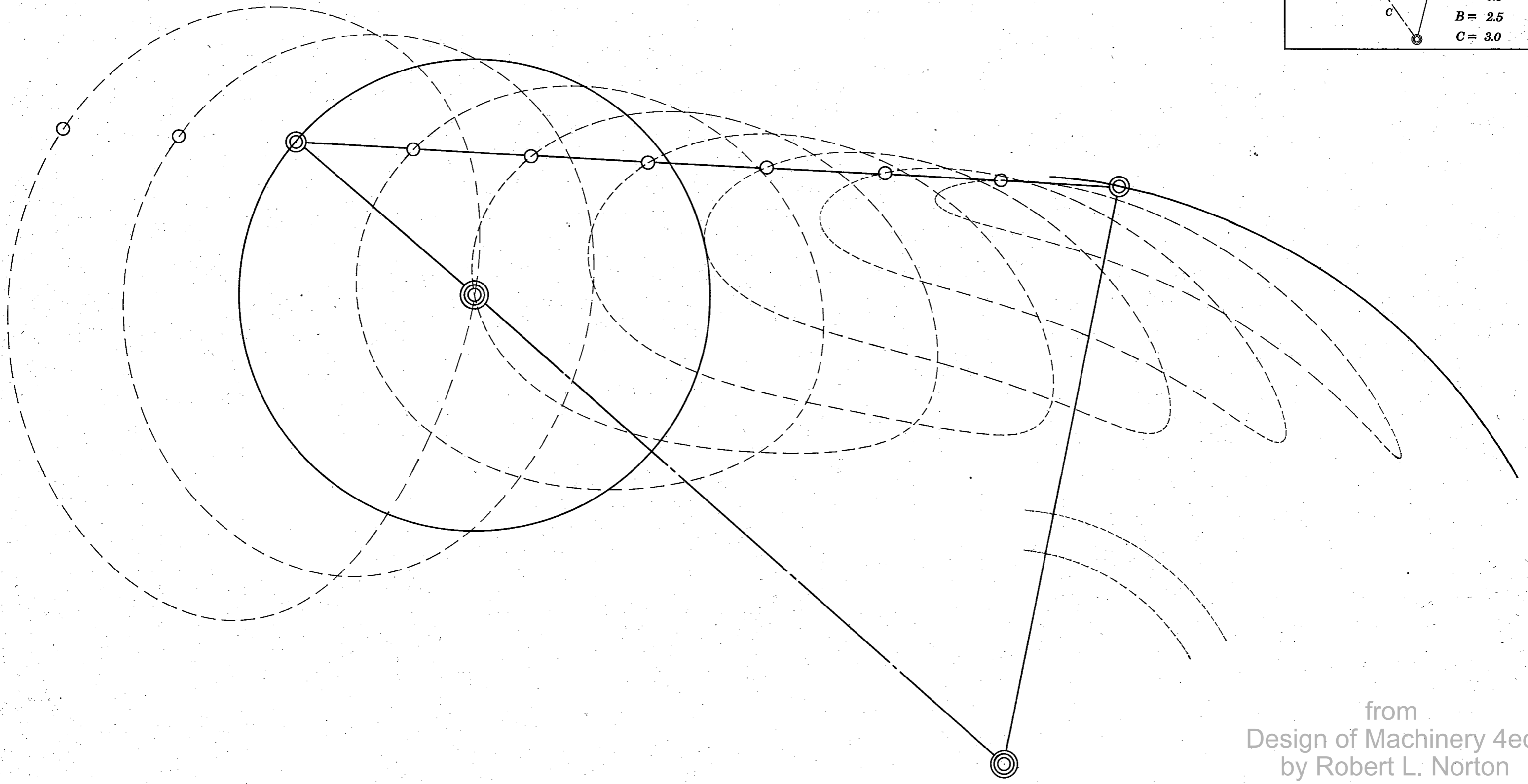
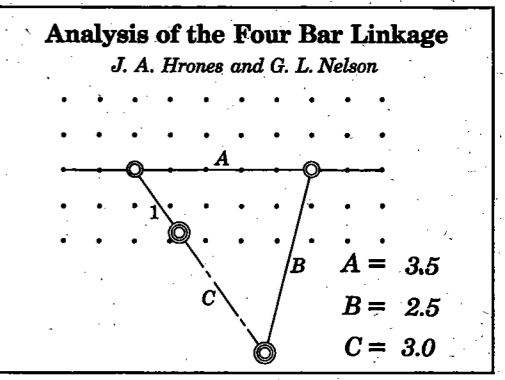

from  
Design of Machinery 4ed  
by Robert L. Norton  
McGraw-Hill  
Copyright 2008

**Analysis of the Four Bar Linkage**  
*J. A. Hrones and G. L. Nelson*

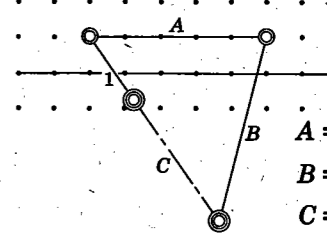

$A = 3.5$   
 $B = 2.5$   
 $C = 3.0$

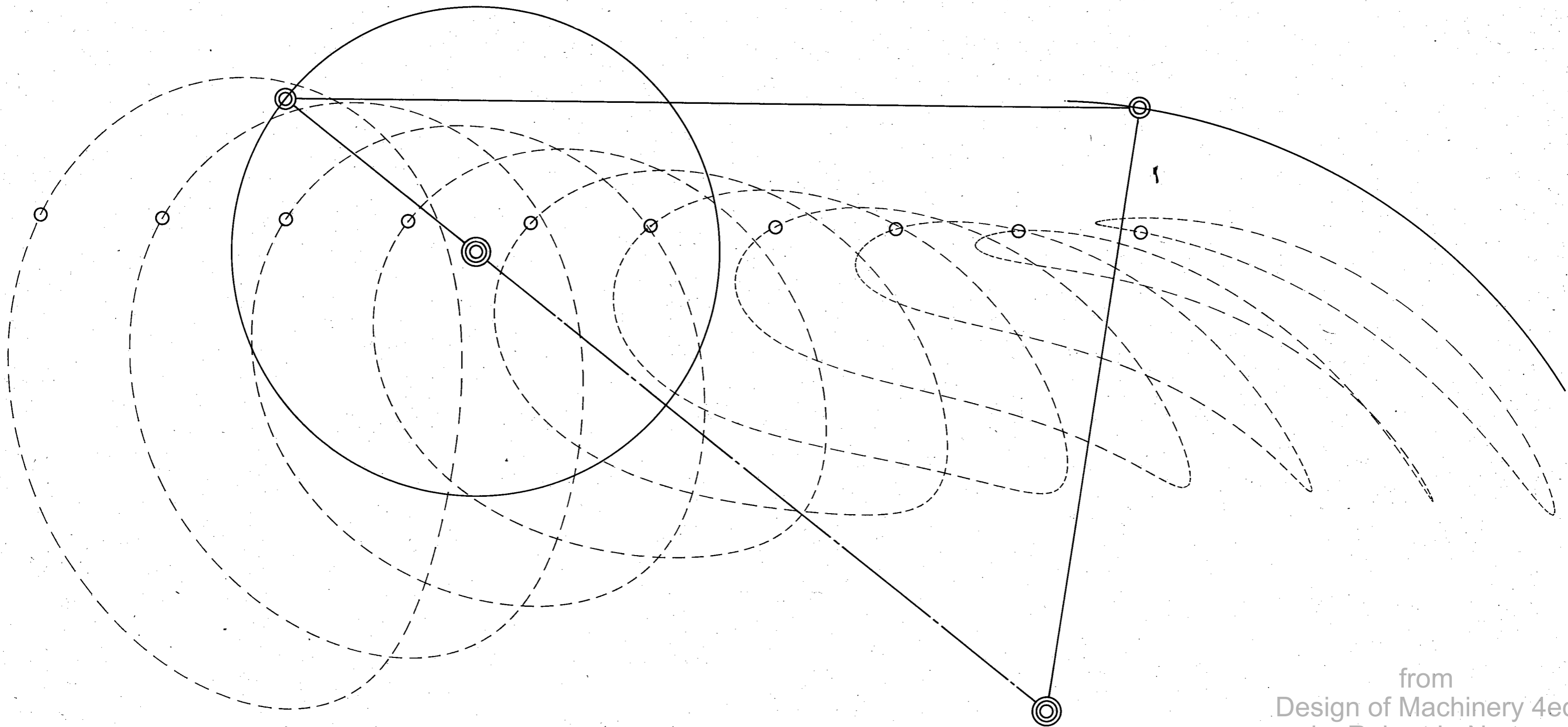

from  
 Design of Machinery 4ed  
 by Robert L. Norton  
 McGraw-Hill  
 Copyright 2008



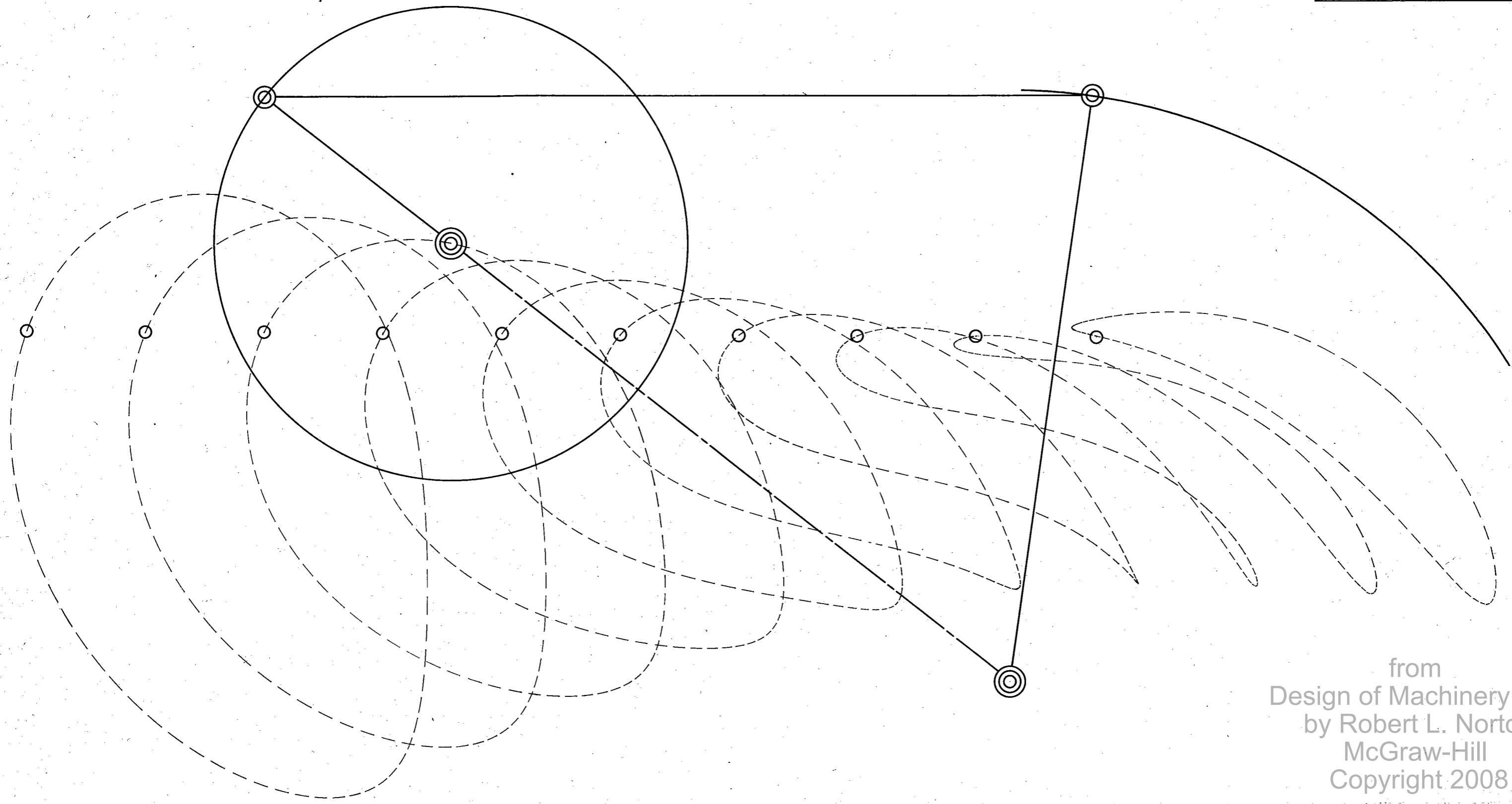
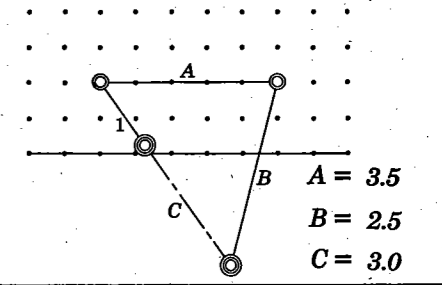

from  
Design of Machinery 4ed  
by Robert L. Norton  
McGraw-Hill  
Copyright 2008

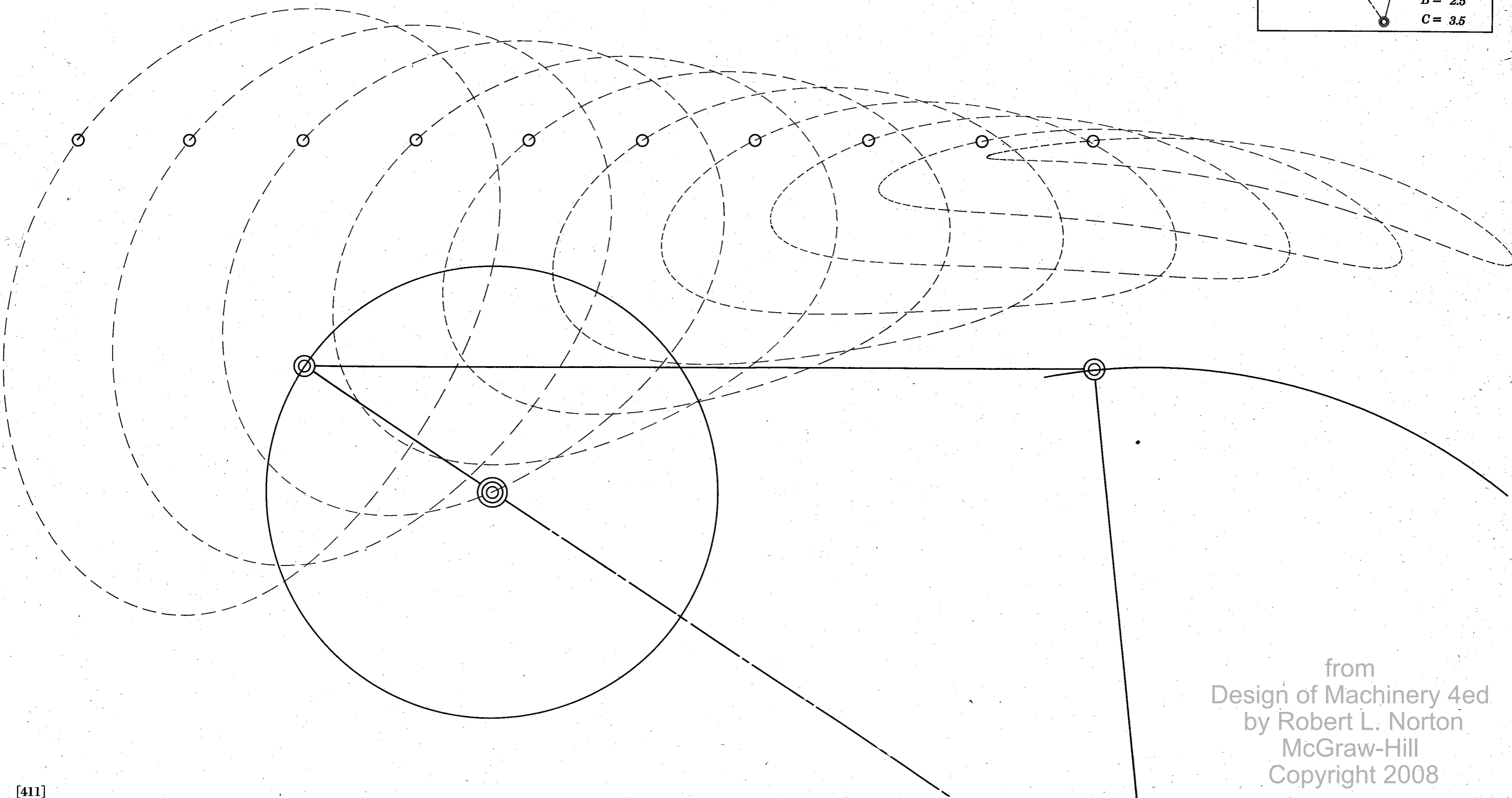
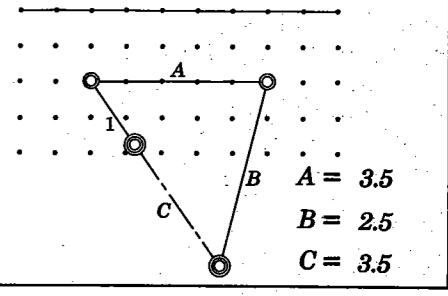

from  
Design of Machinery 4ed  
by Robert L. Norton  
McGraw-Hill  
Copyright 2008

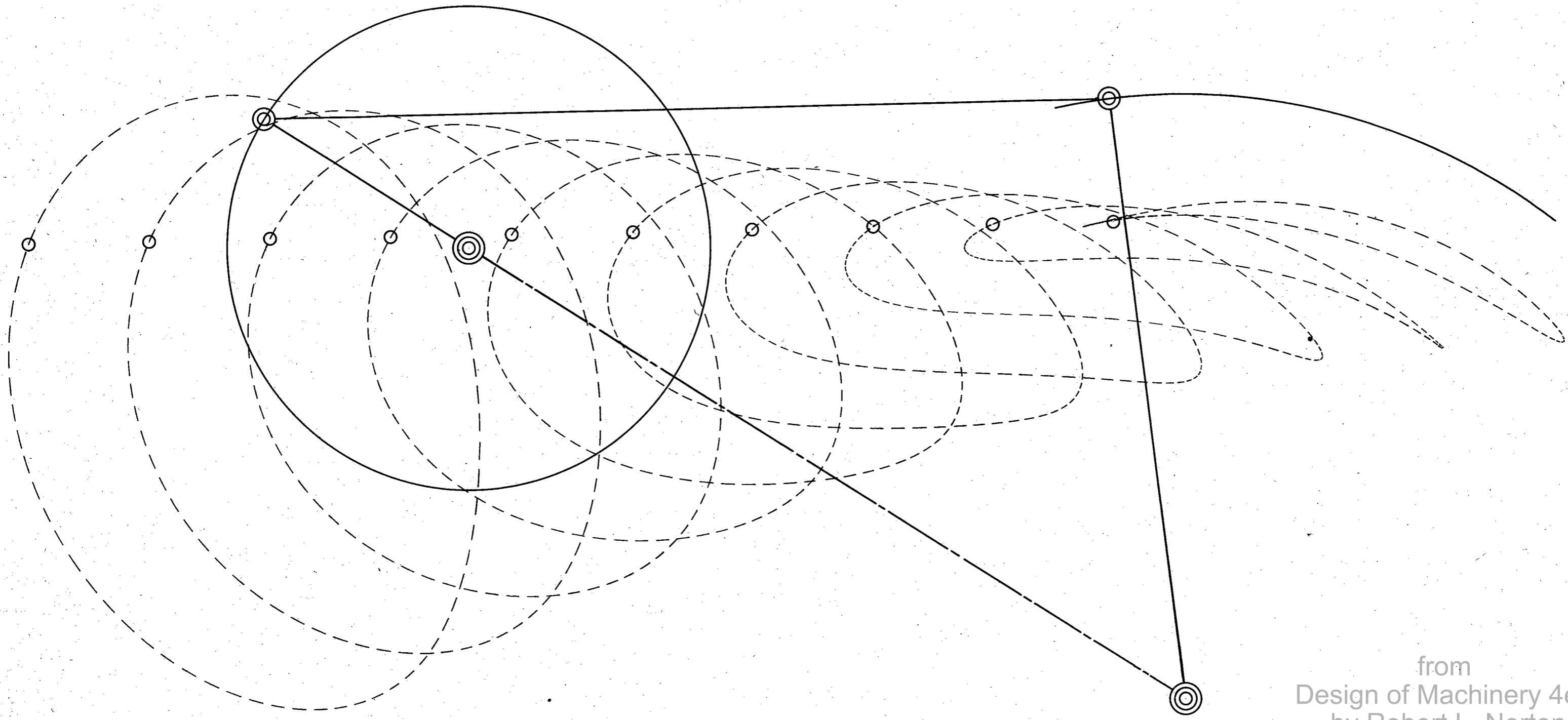
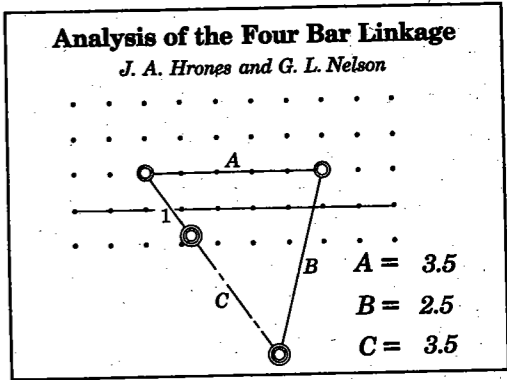

from  
Design of Machinery 4ed  
by Robert L. Norton  
McGraw-Hill  
Copyright 2008

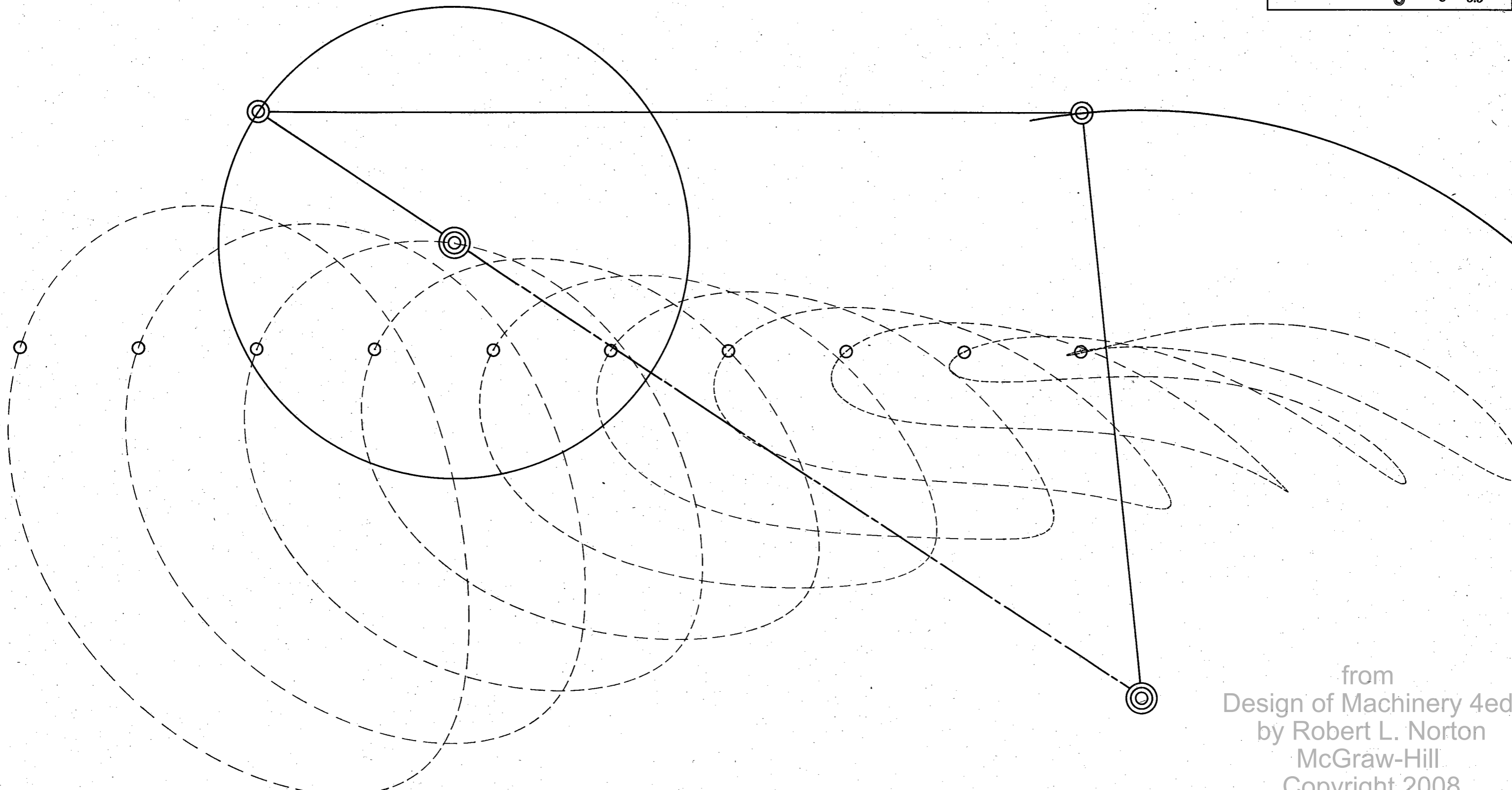
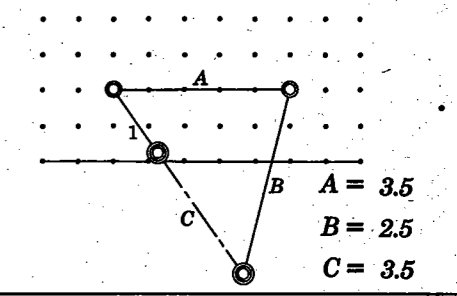

from  
Design of Machinery 4ed  
by Robert L. Norton  
McGraw-Hill  
Copyright 2008

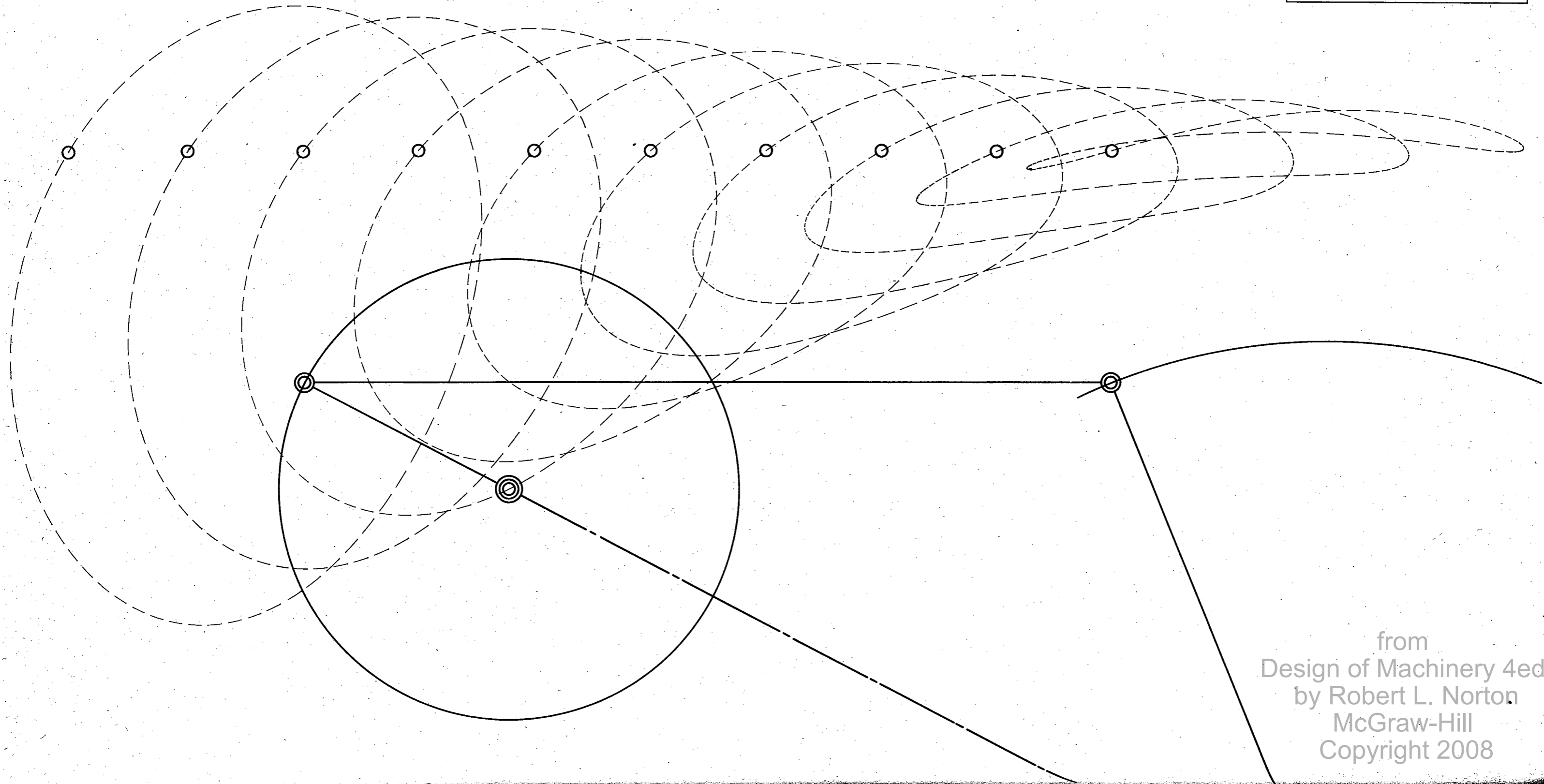
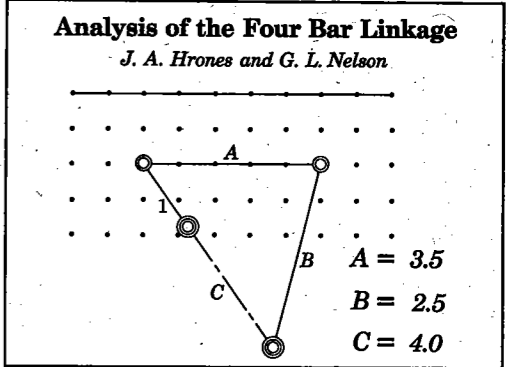

from  
Design of Machinery 4ed  
by Robert L. Norton  
McGraw-Hill  
Copyright 2008

**Analysis of the Four Bar Linkage**  
*J. A. Hrones and G. L. Nelson*

$A = 3.5$   
 $B = 2.5$   
 $C = 4.0$

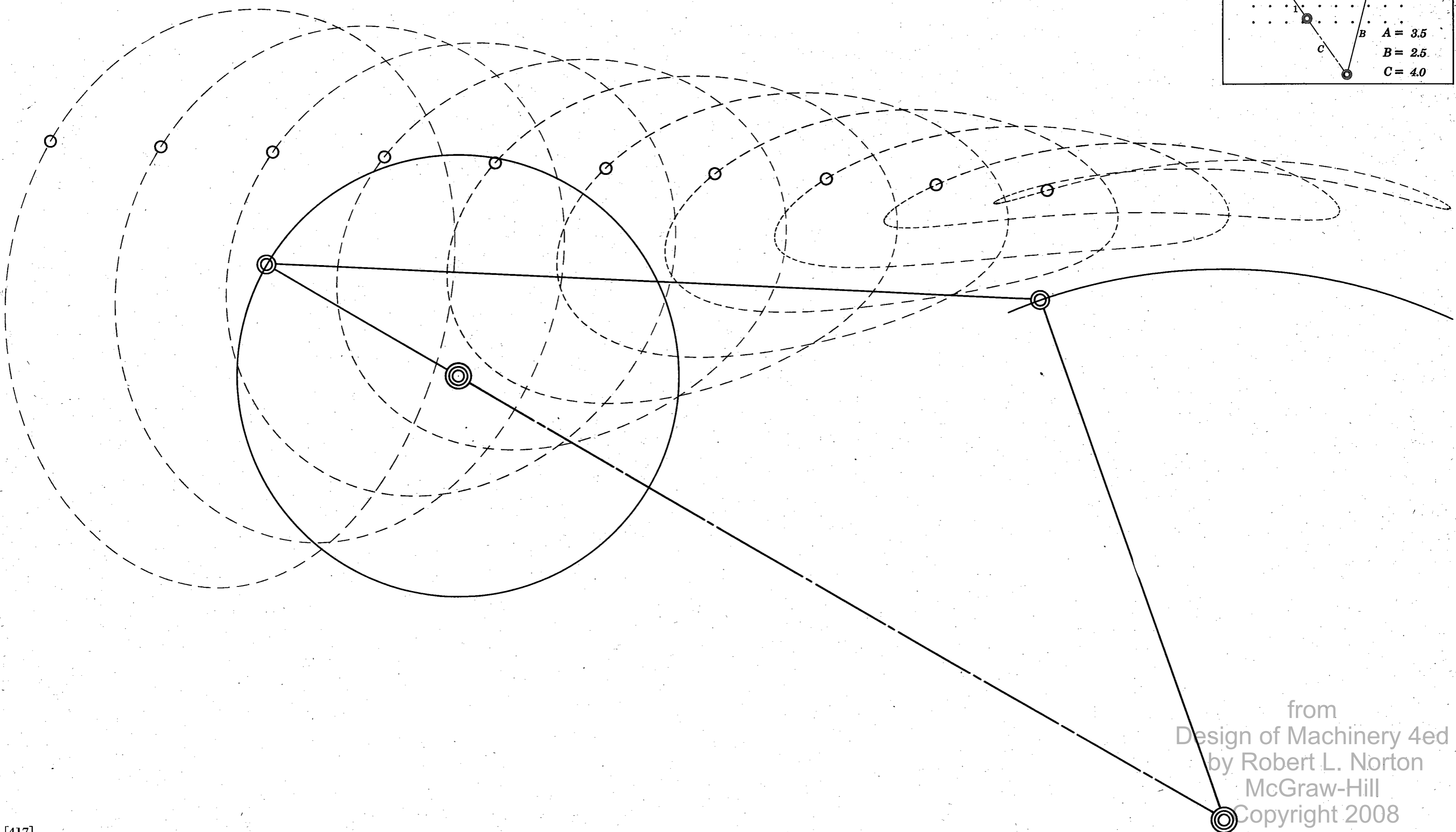

from  
 Design of Machinery 4ed  
 by Robert L. Norton  
 McGraw-Hill  
 Copyright 2008

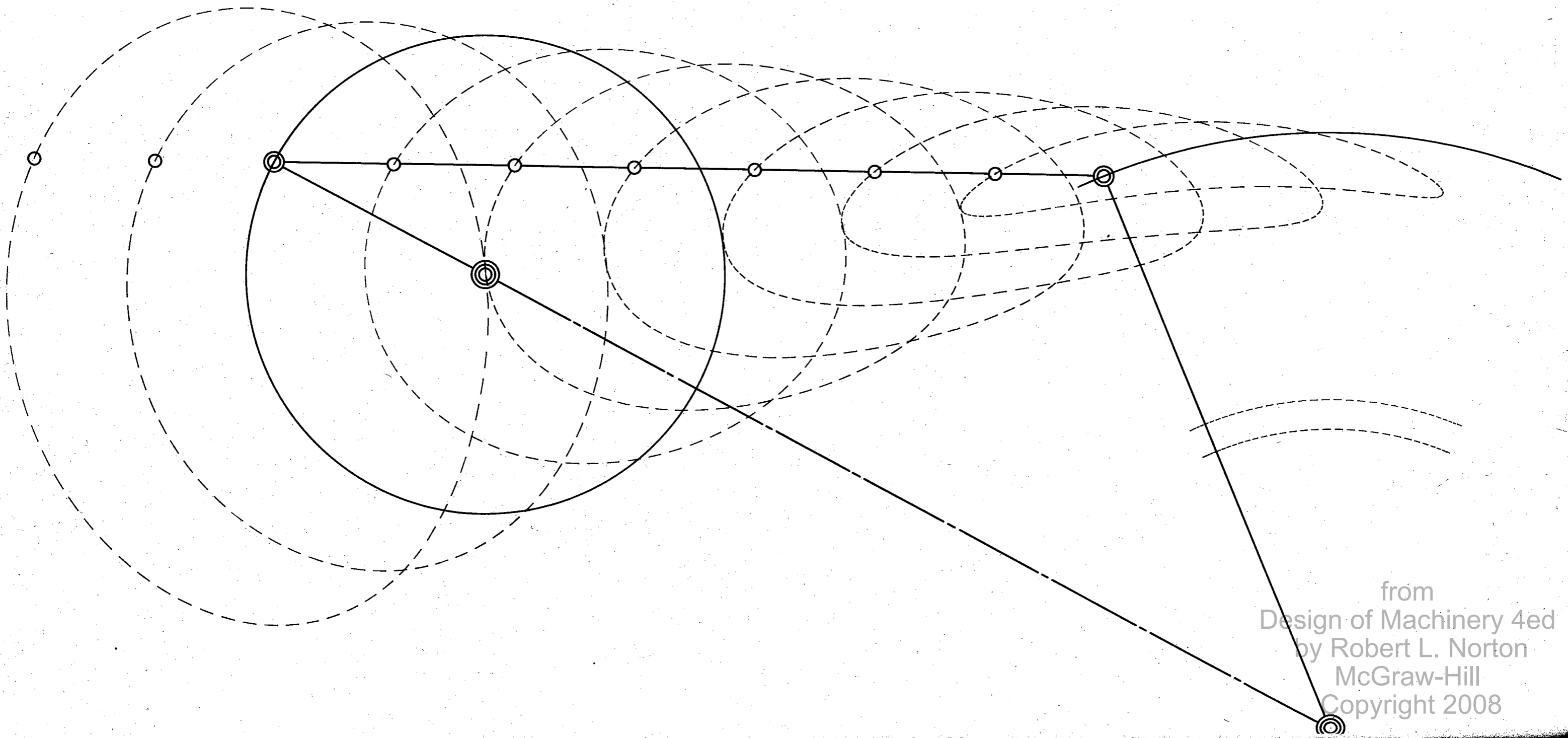
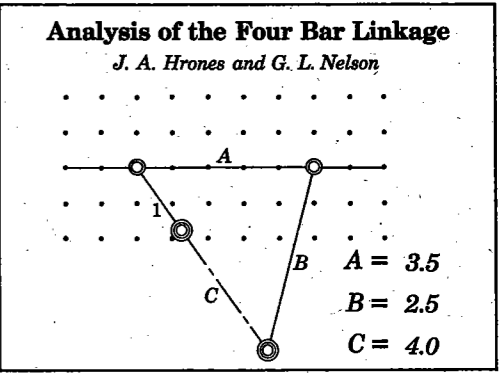

from  
Design of Machinery 4ed  
by Robert L. Norton  
McGraw-Hill  
Copyright 2008

**Analysis of the Four Bar Linkage**  
*J. A. Hrones and G. L. Nelson*

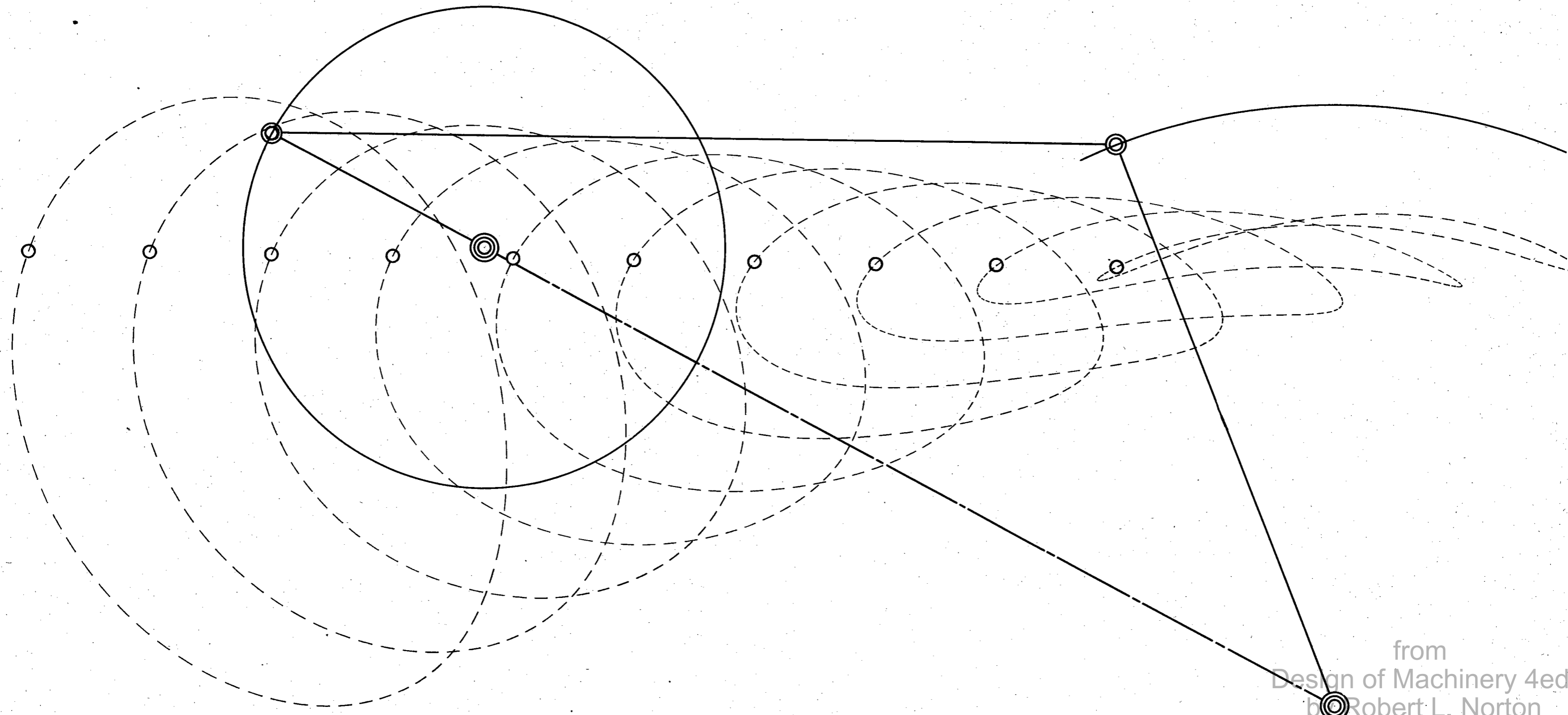
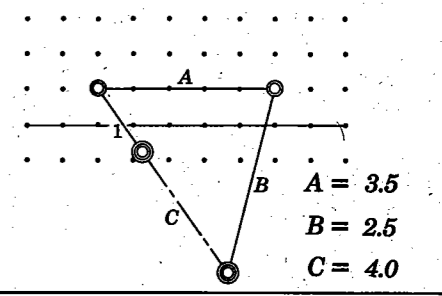

from  
 Design of Machinery 4ed  
 by Robert L. Norton  
 McGraw-Hill  
 Copyright 2008



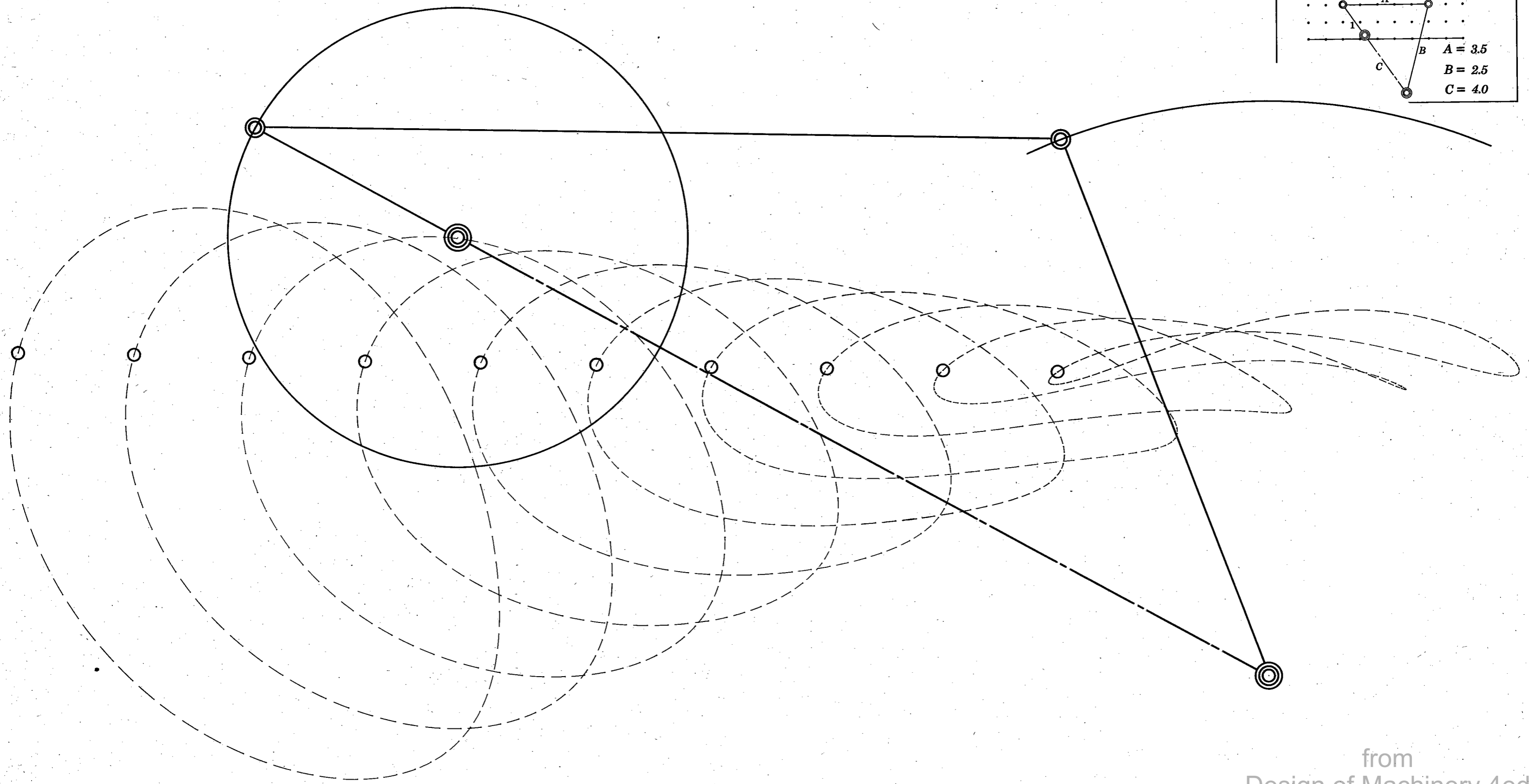
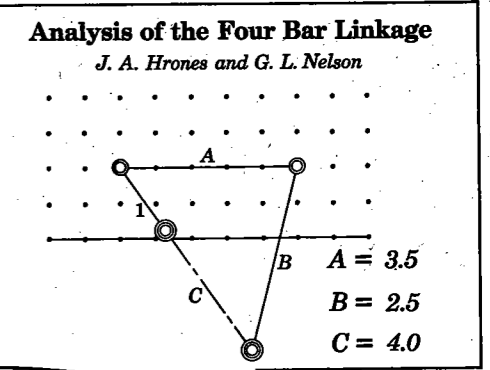

from  
Design of Machinery 4ed  
by Robert L. Norton  
McGraw-Hill  
Copyright 2008

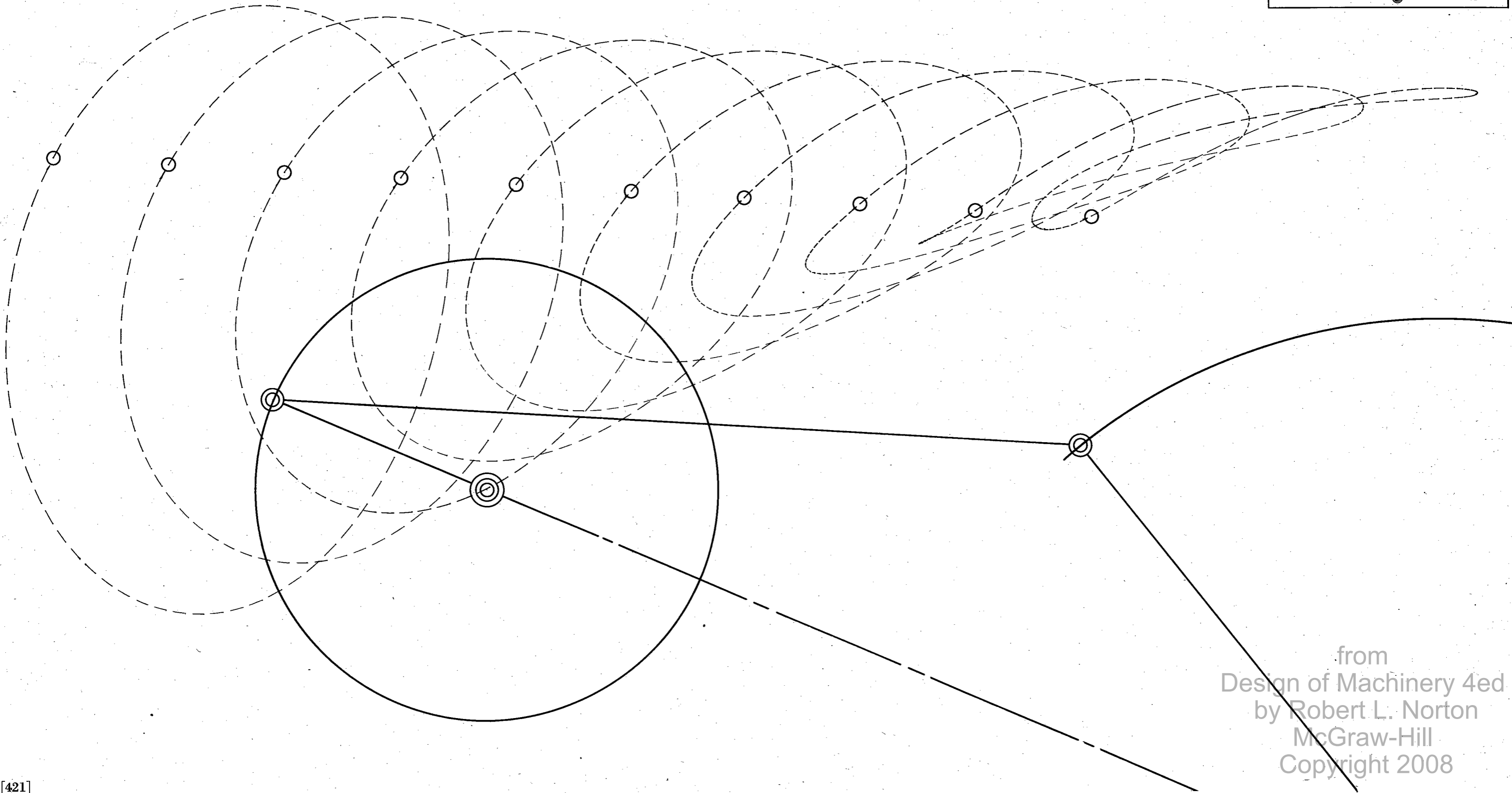
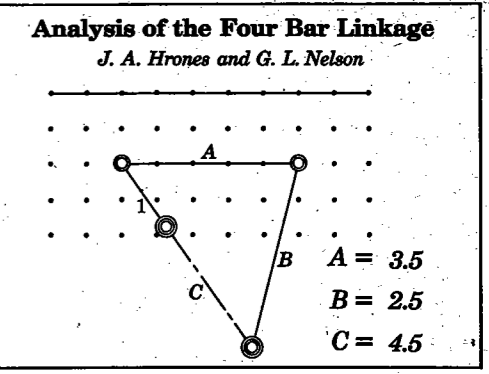

from  
 Design of Machinery 4ed  
 by Robert L. Norton  
 McGraw-Hill  
 Copyright 2008

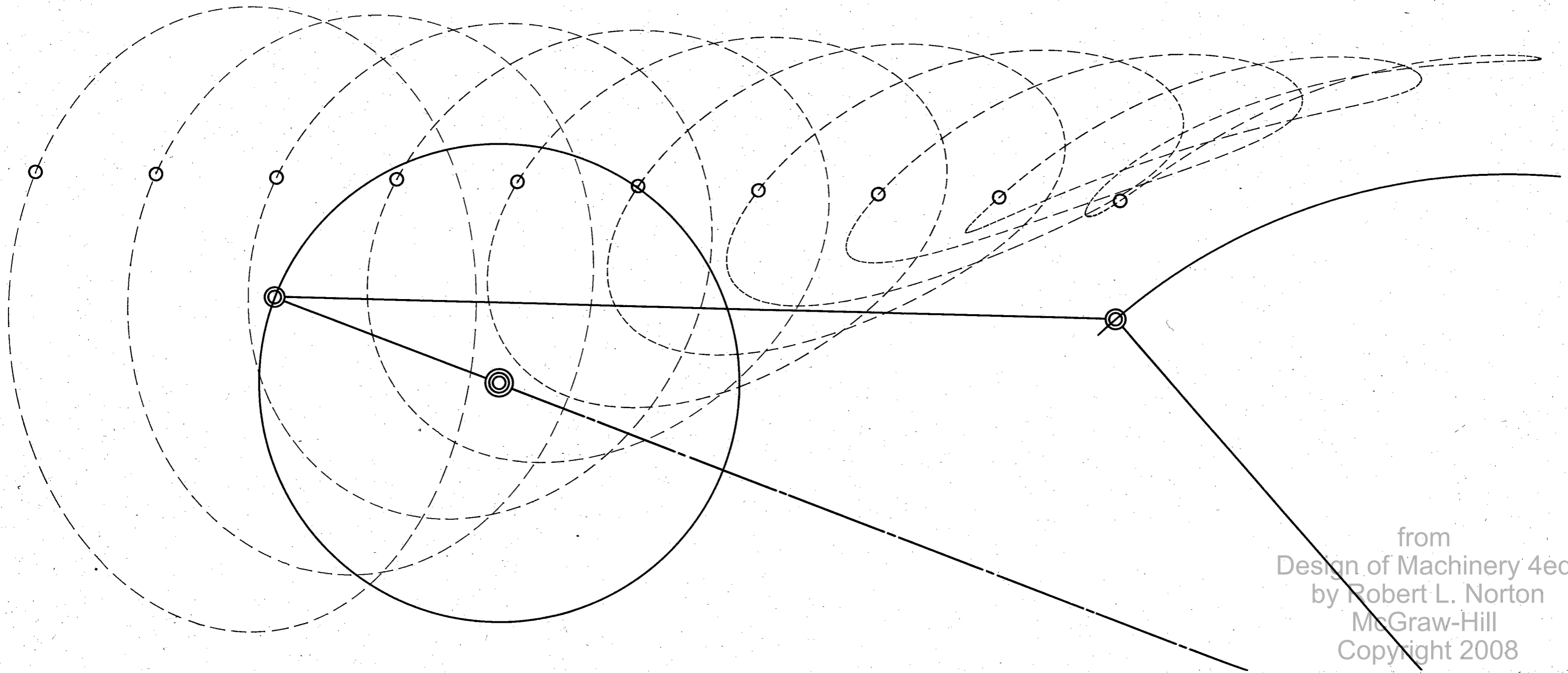
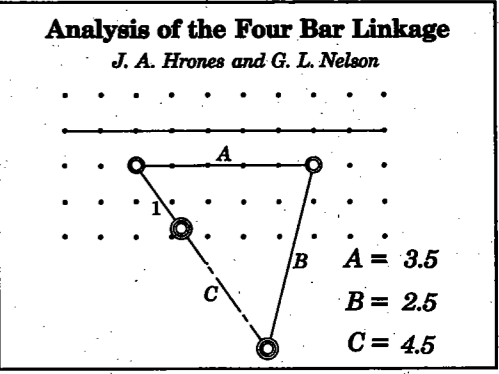

from  
Design of Machinery 4ed  
by Robert L. Norton  
McGraw-Hill  
Copyright 2008

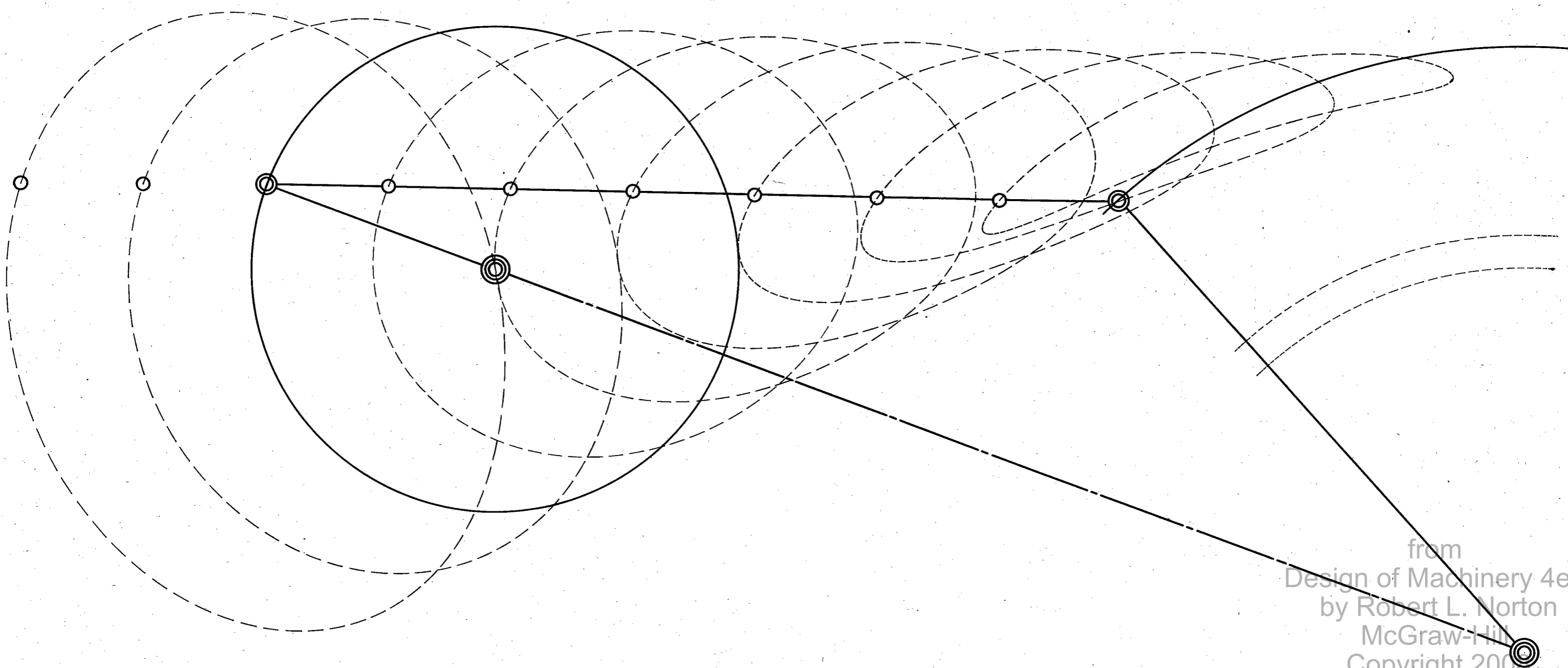
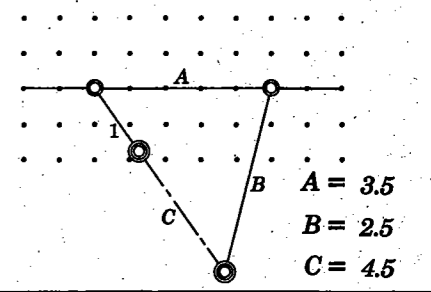

from  
Design of Machinery 4ed  
by Robert L. Norton  
McGraw-Hill  
Copyright 2000

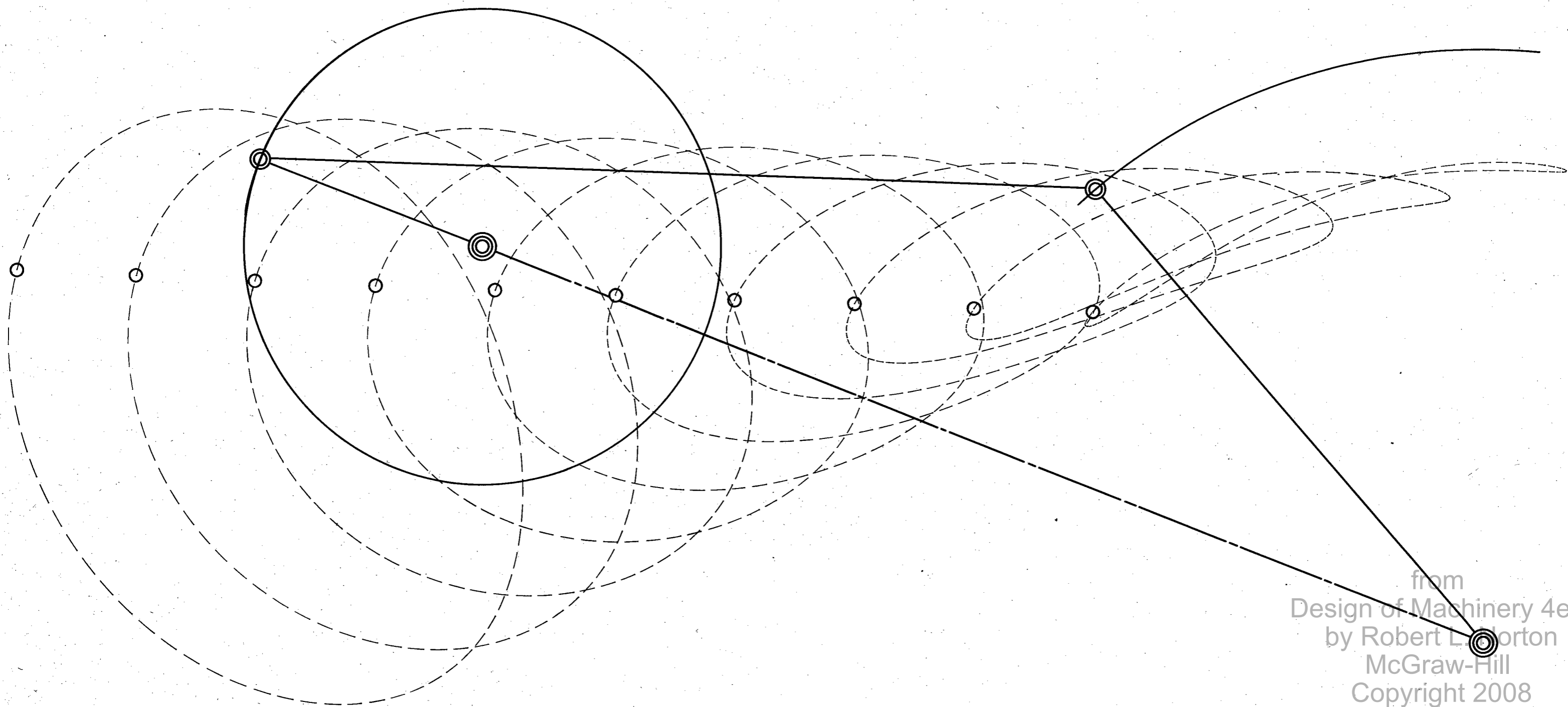
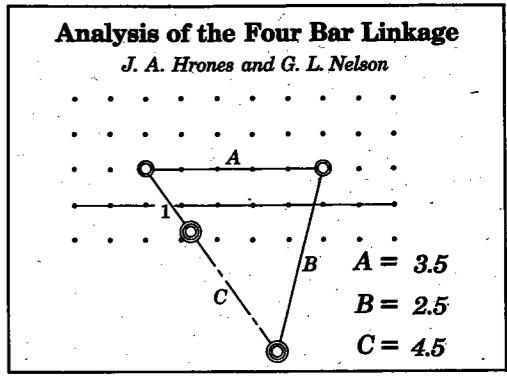

from  
Design of Machinery 4ed  
by Robert L. Norton  
McGraw-Hill  
Copyright 2008

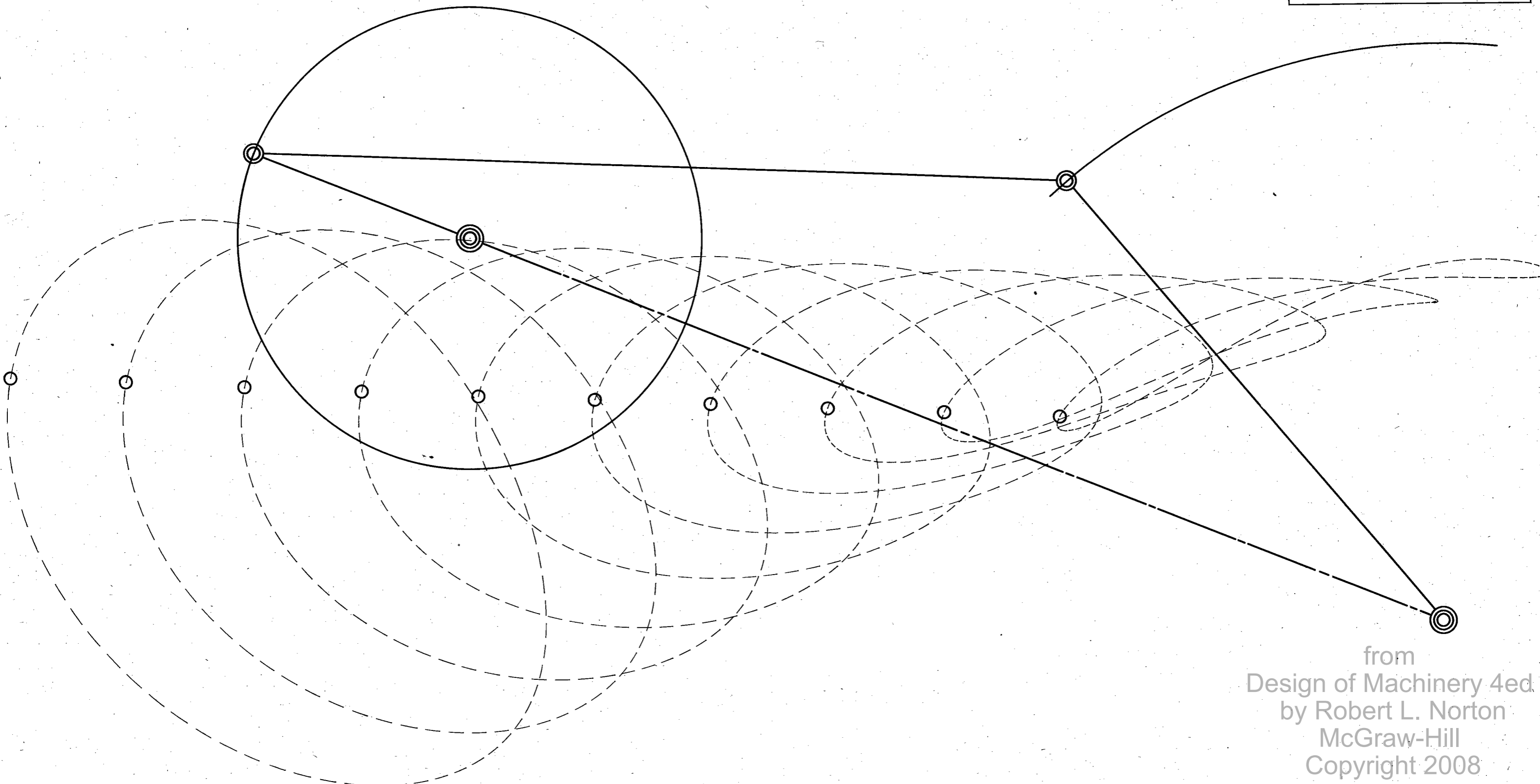
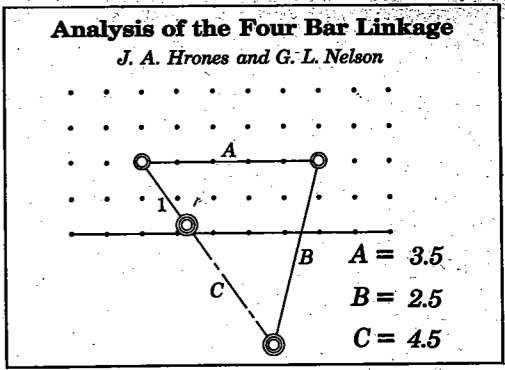

from  
 Design of Machinery 4ed  
 by Robert L. Norton  
 McGraw-Hill  
 Copyright 2008

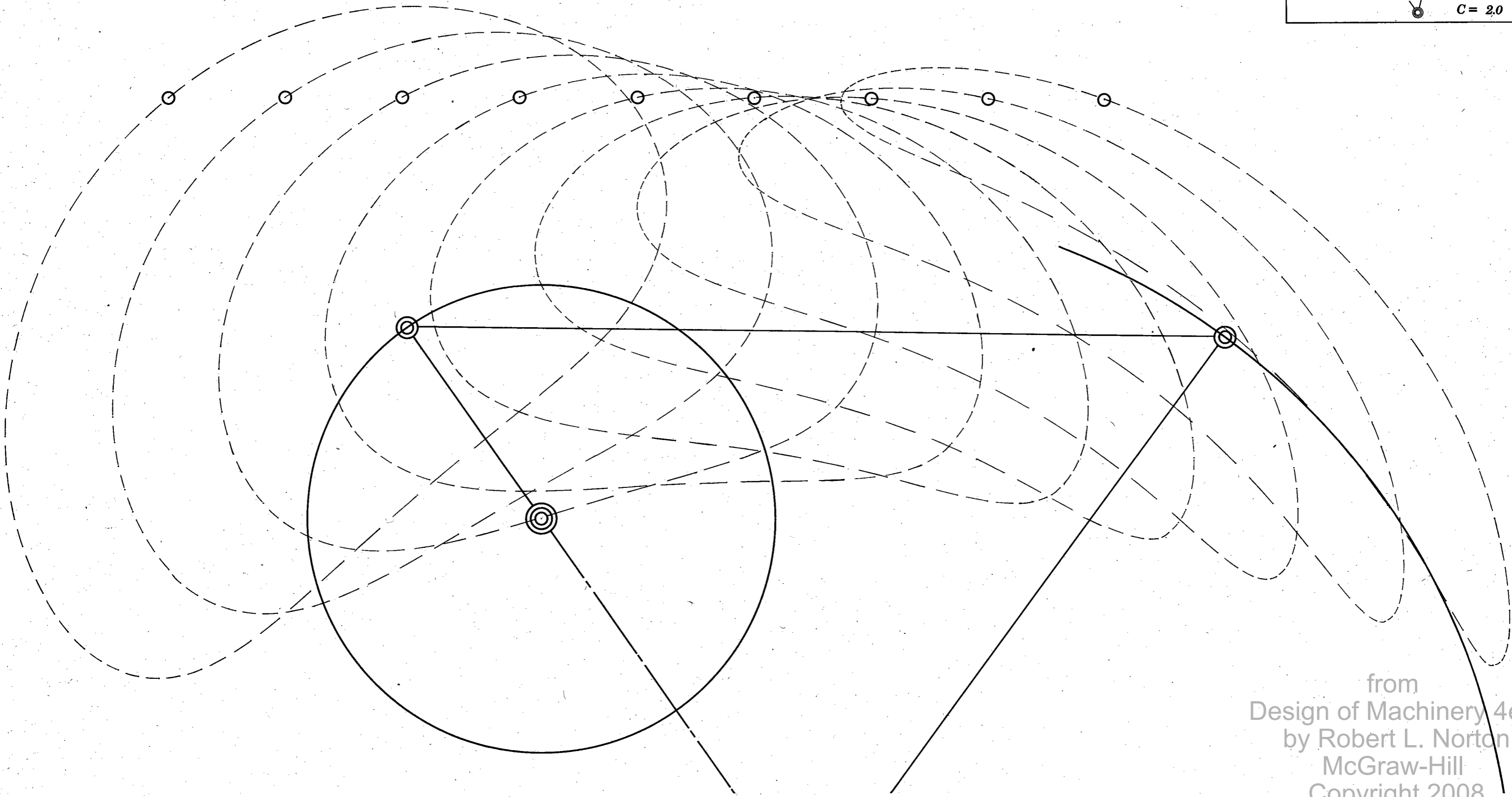
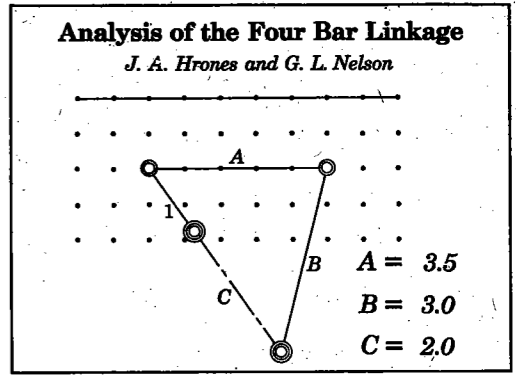

from  
Design of Machinery 4ed  
by Robert L. Norton  
McGraw-Hill  
Copyright 2008

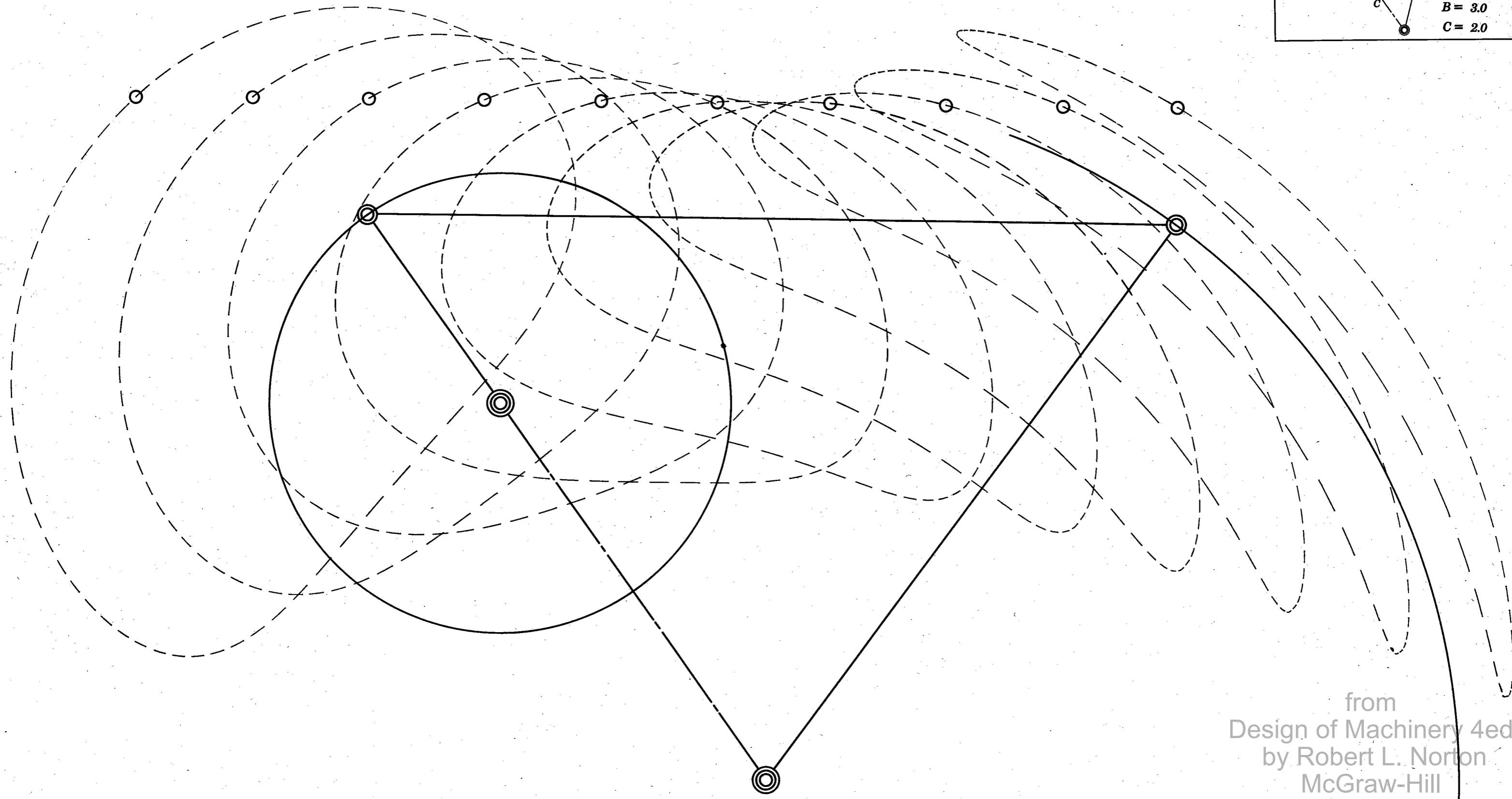
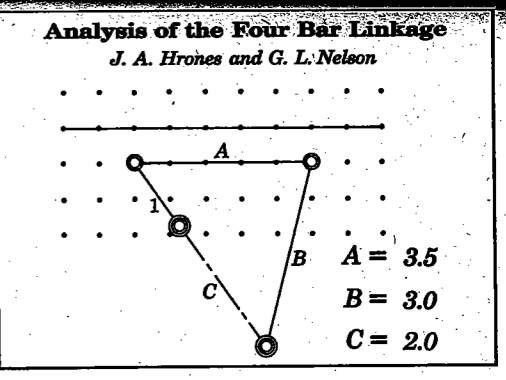

from  
 Design of Machinery 4ed  
 by Robert L. Norton  
 McGraw-Hill  
 Copyright 2008



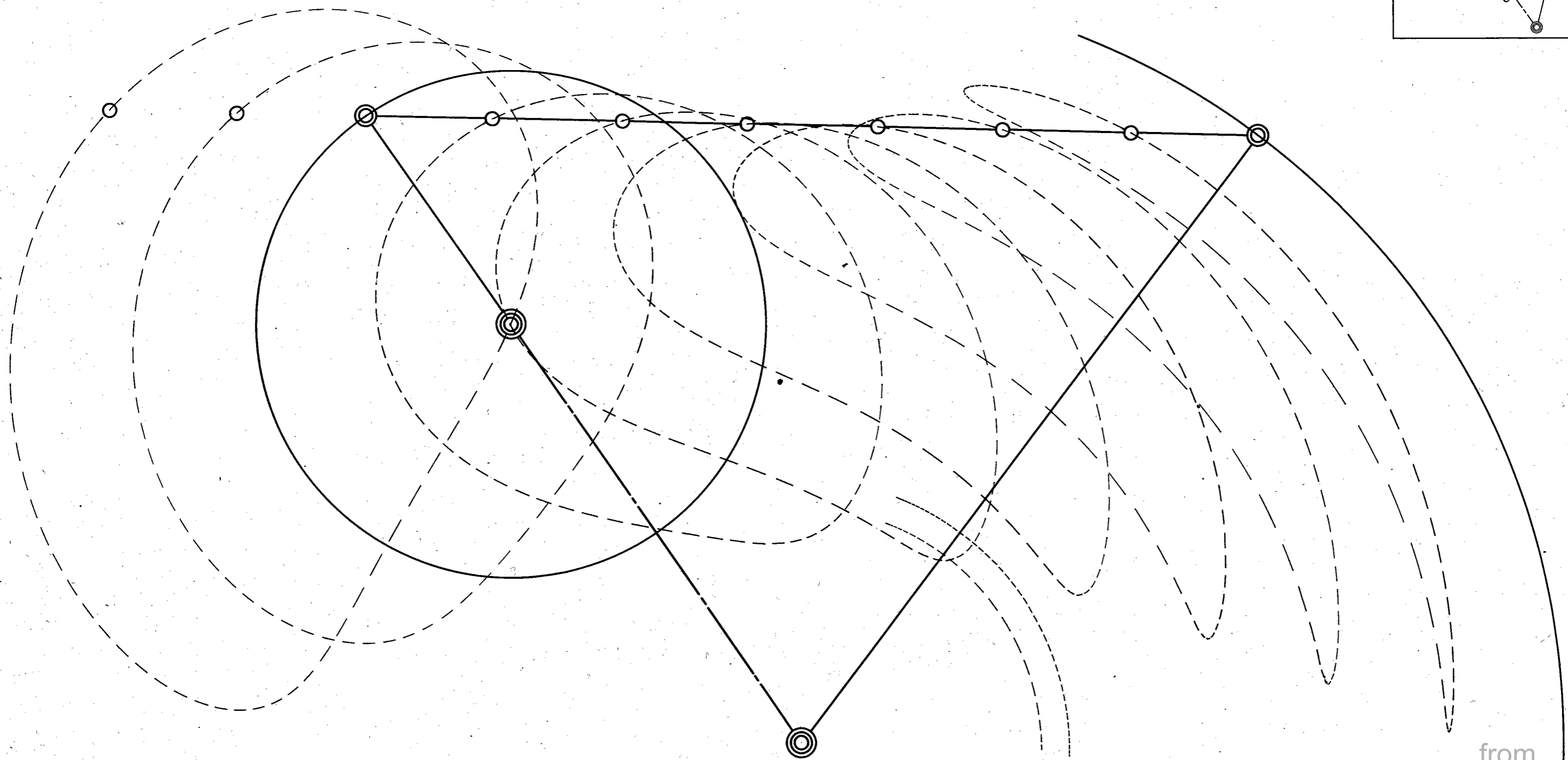
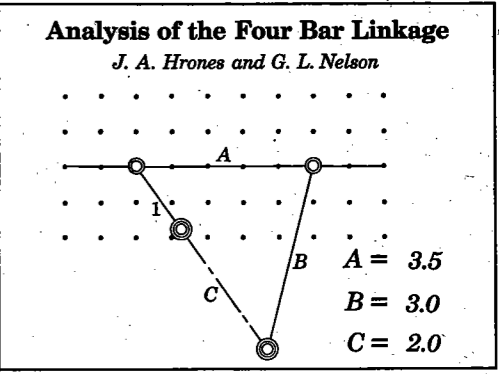

from  
Design of Machinery 4ed  
by Robert L. Norton  
McGraw-Hill  
Copyright 2008

**Analysis of the Four Bar Linkage**

*J. A. Hrones and G. L. Nelson*

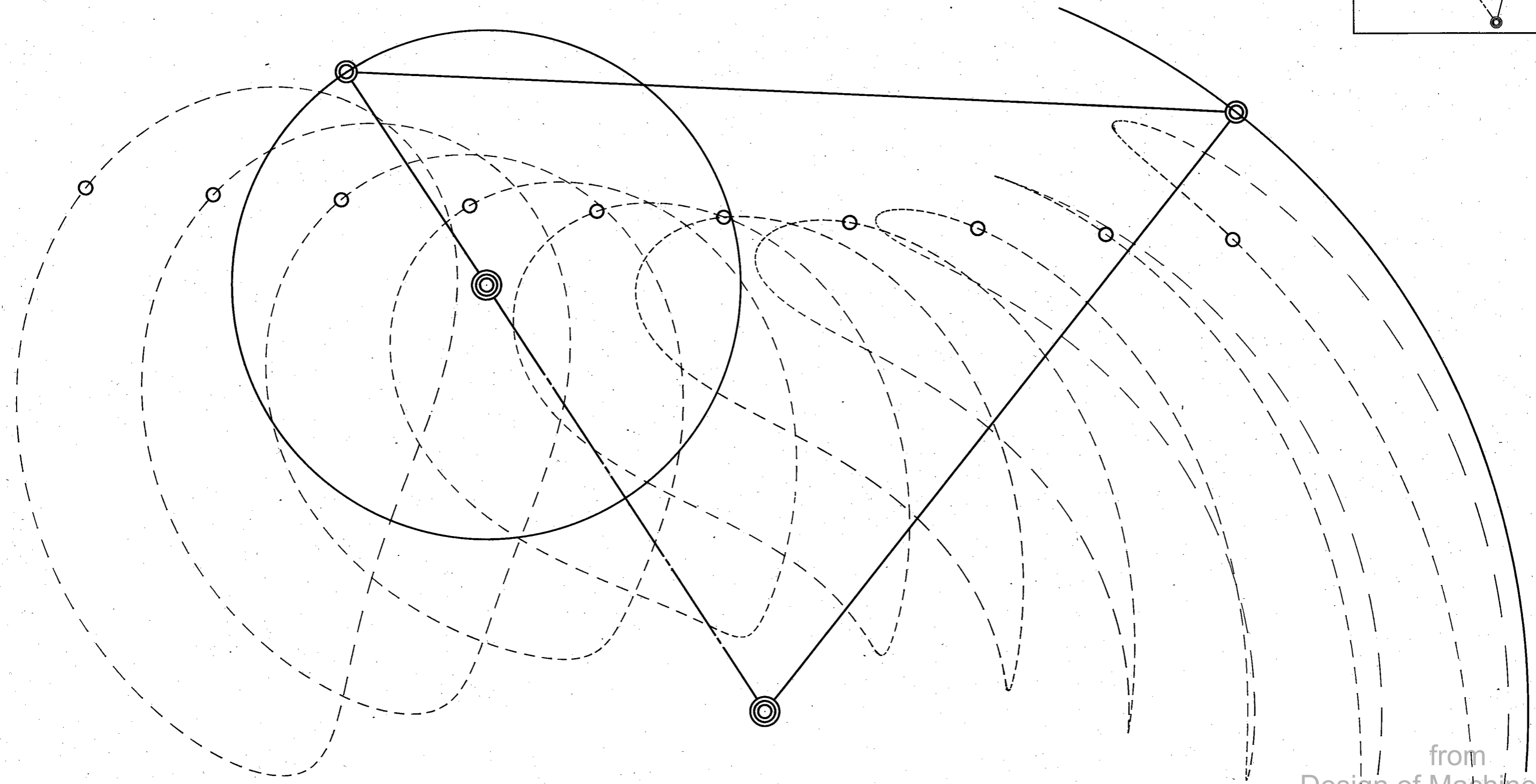
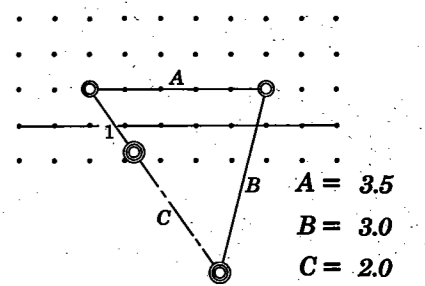

from  
Design of Machinery 4ed.  
by Robert L. Norton  
McGraw-Hill  
Copyright 2008

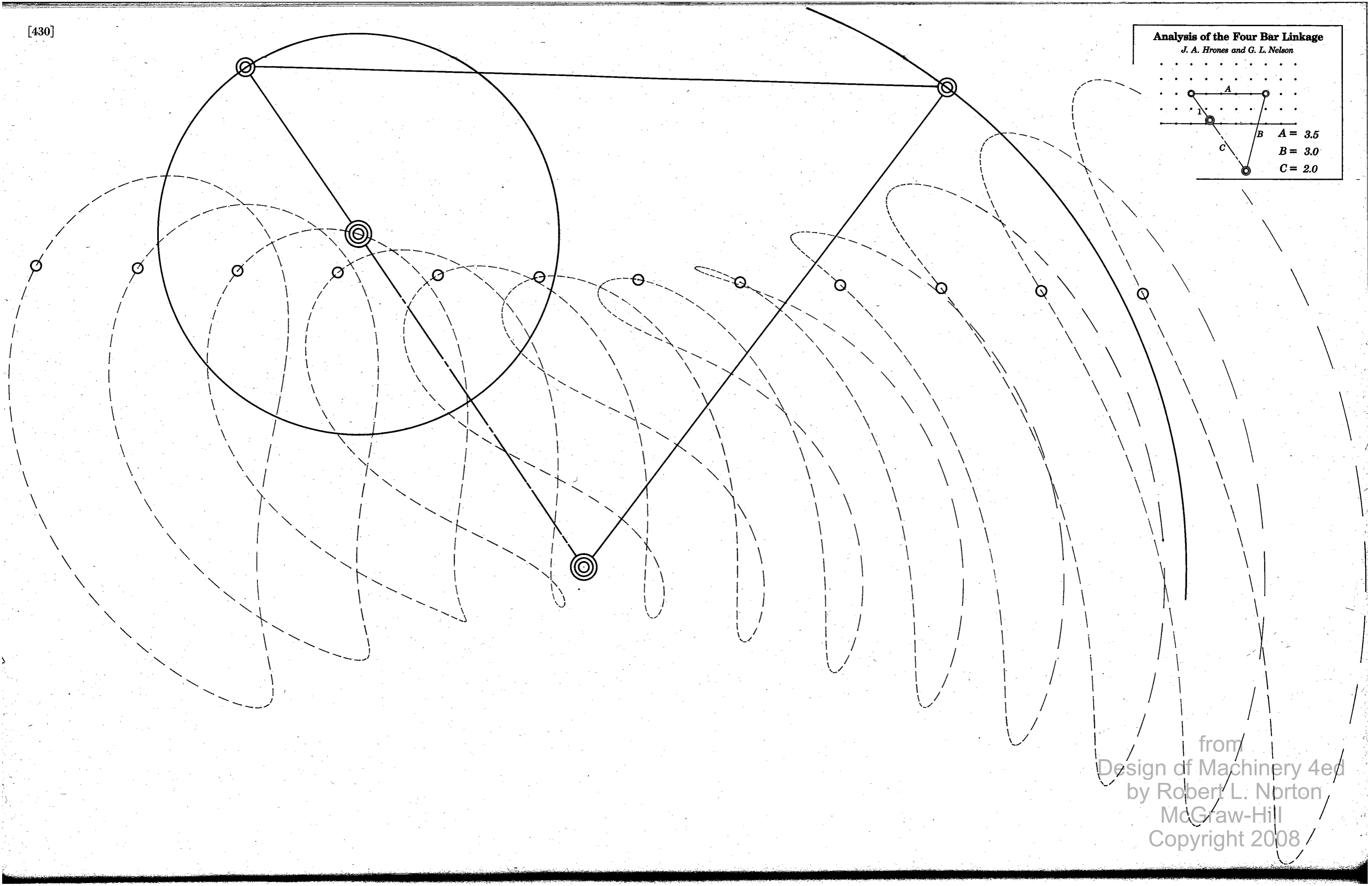
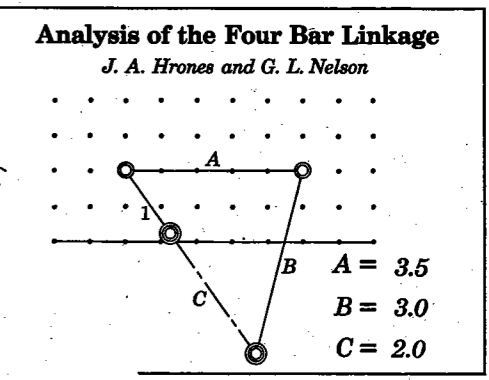

from  
Design of Machinery 4ed  
by Robert L. Norton  
McGraw-Hill  
Copyright 2008

**Analysis of the Four Bar Linkage**

*J. A. Hrones and G. L. Nelson*

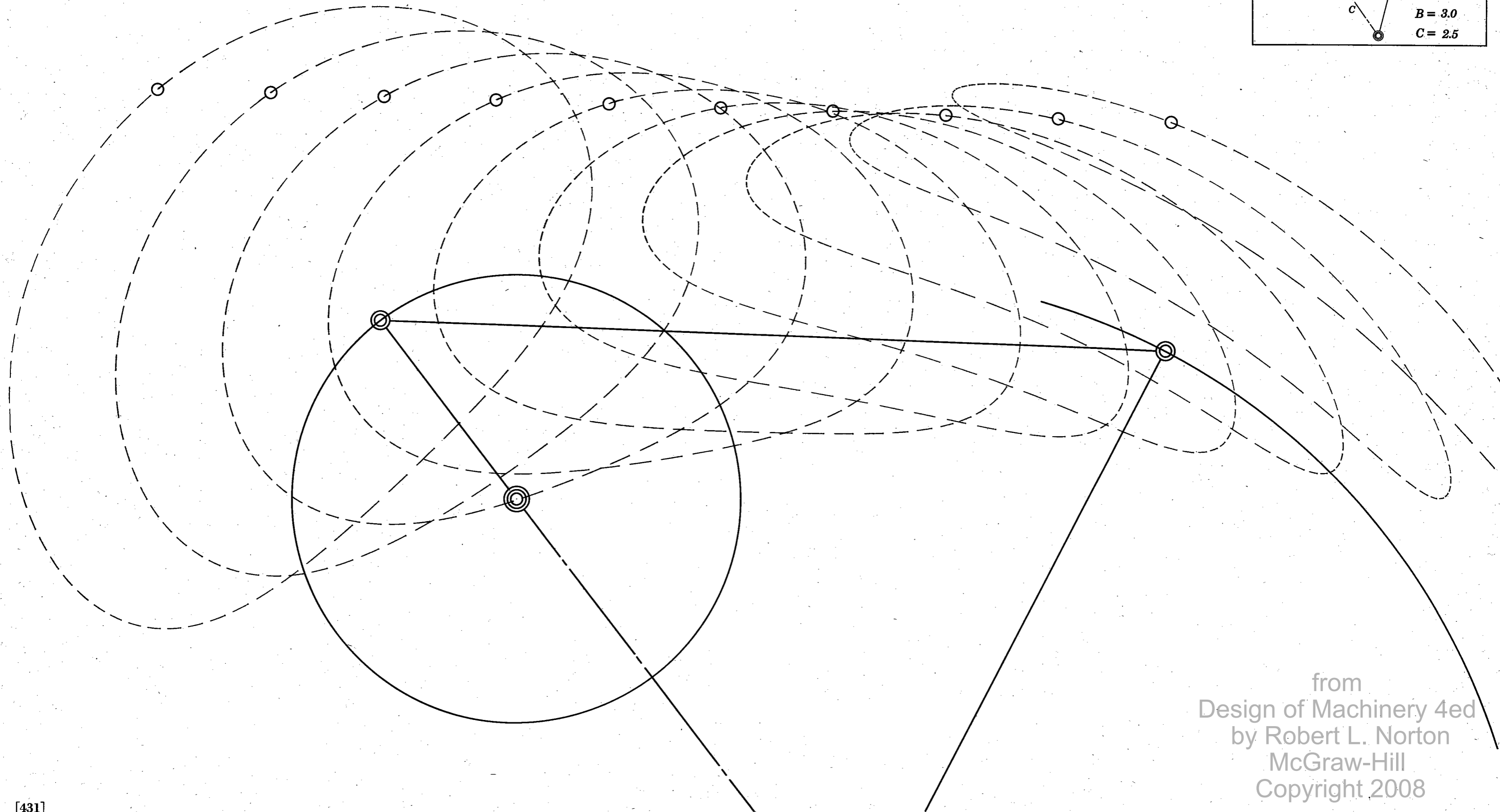
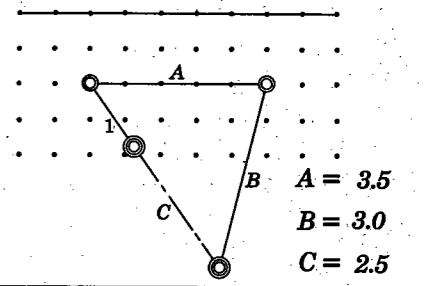

from  
Design of Machinery 4ed  
by Robert L. Norton  
McGraw-Hill  
Copyright 2008

**Analysis of the Four Bar Linkage**  
*J. A. Hrones and G. L. Nelson*

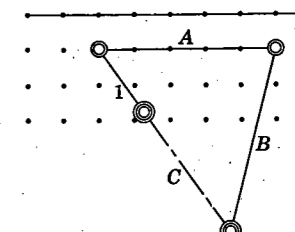

$A = 3.5$   
 $B = 3.0$   
 $C = 2.5$

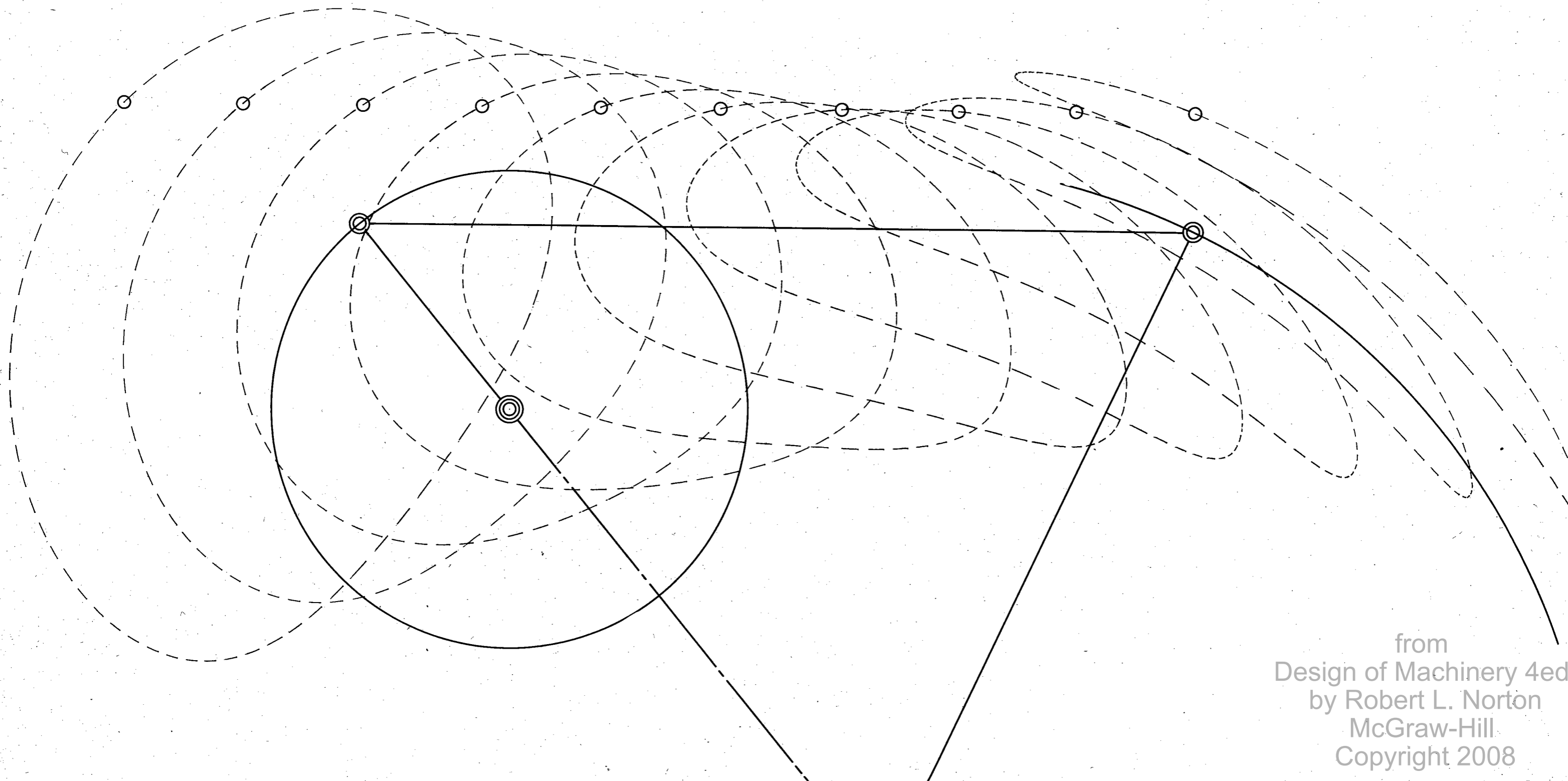

from  
Design of Machinery 4ed  
by Robert L. Norton  
McGraw-Hill  
Copyright 2008

**Analysis of the Four Bar Linkage**

*J. A. Hrones and G. L. Nelson*

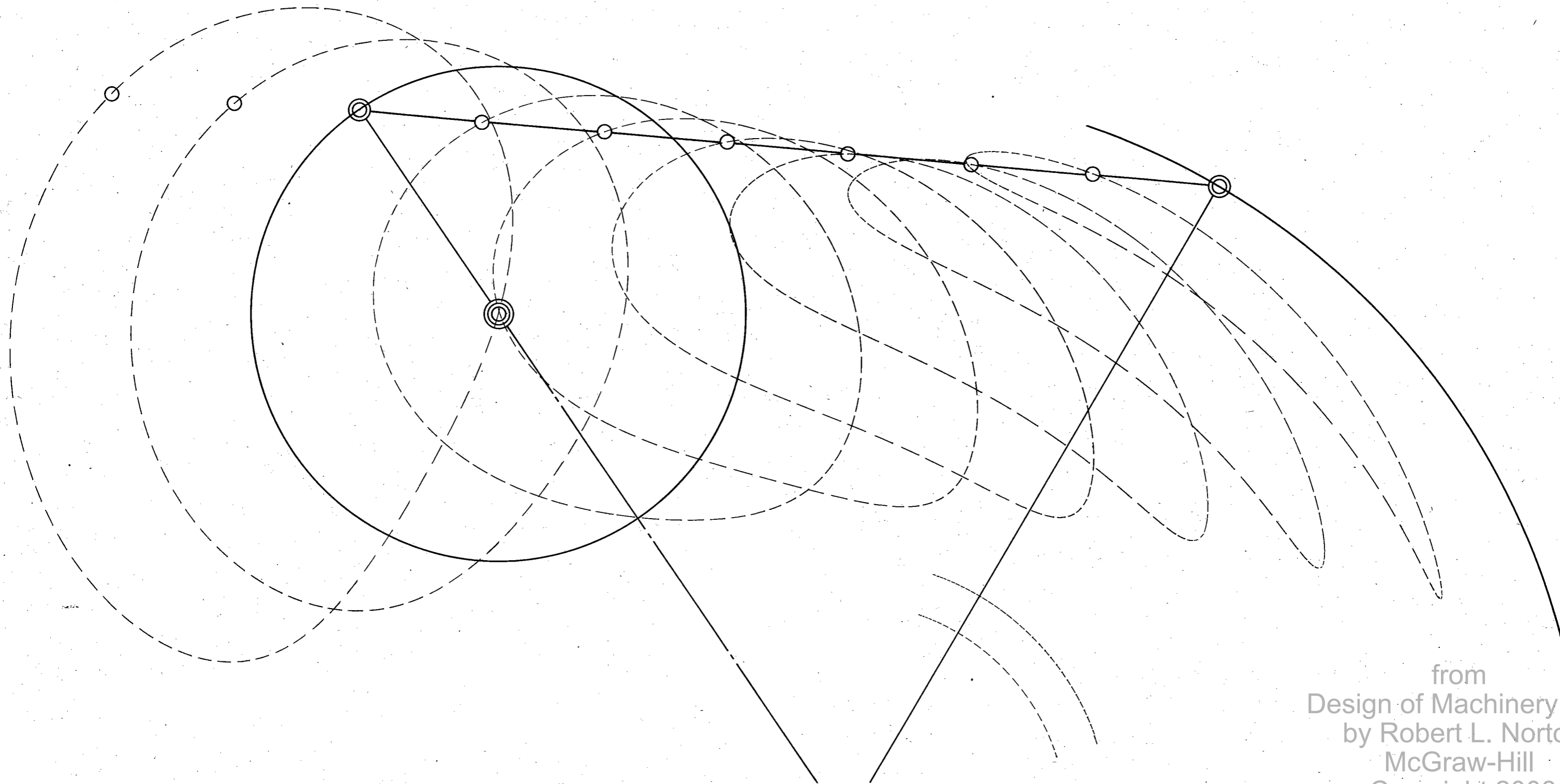
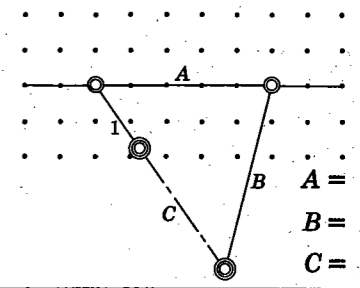

from  
Design of Machinery 4ed  
by Robert L. Norton  
McGraw-Hill  
Copyright 2008

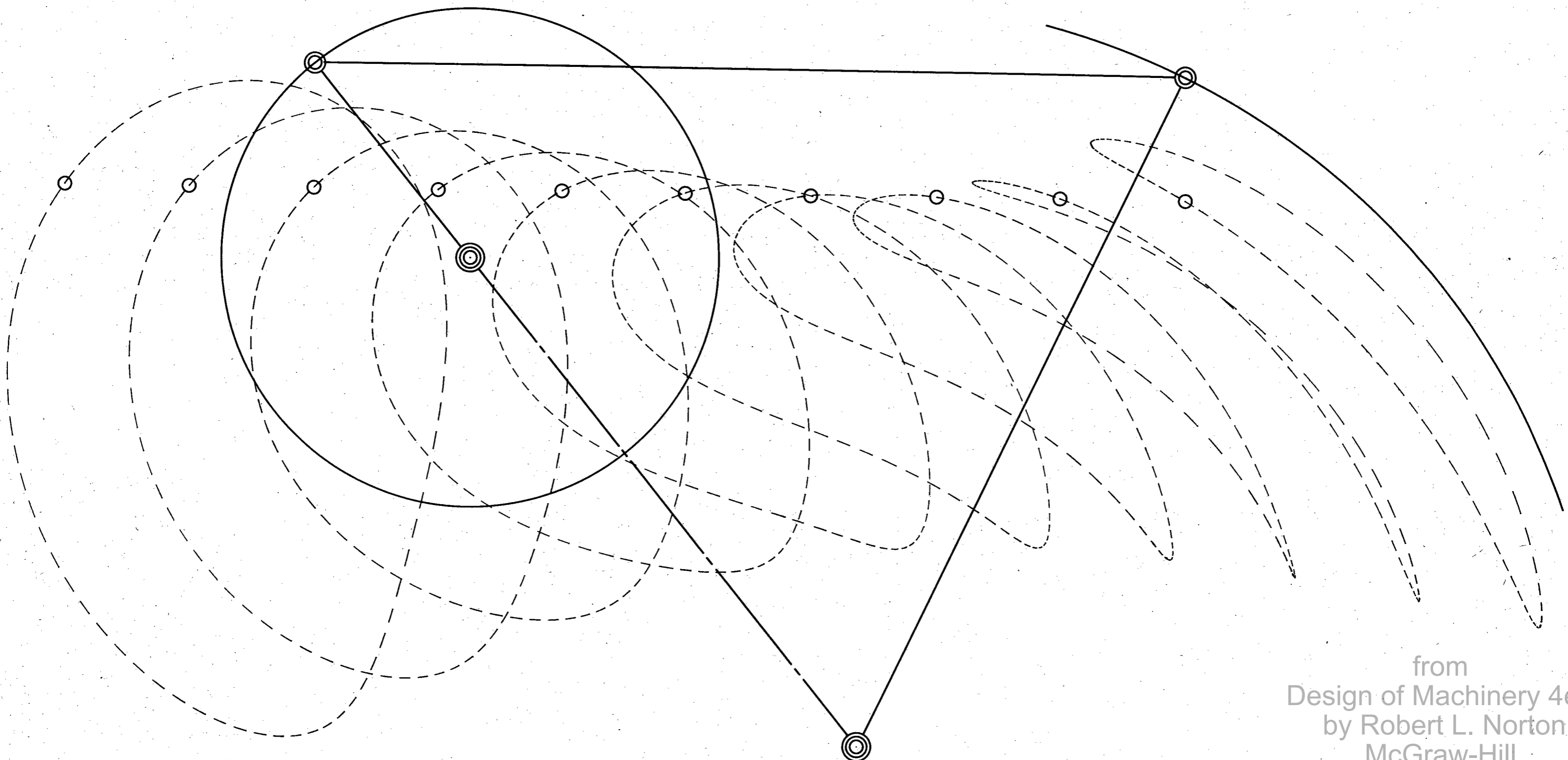
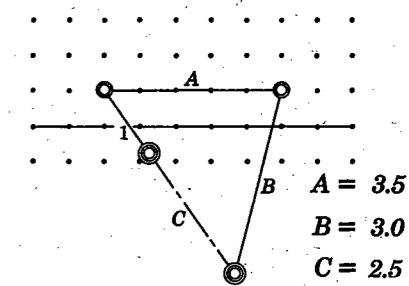

from  
Design of Machinery 4ed  
by Robert L. Norton  
McGraw-Hill  
Copyright 2008

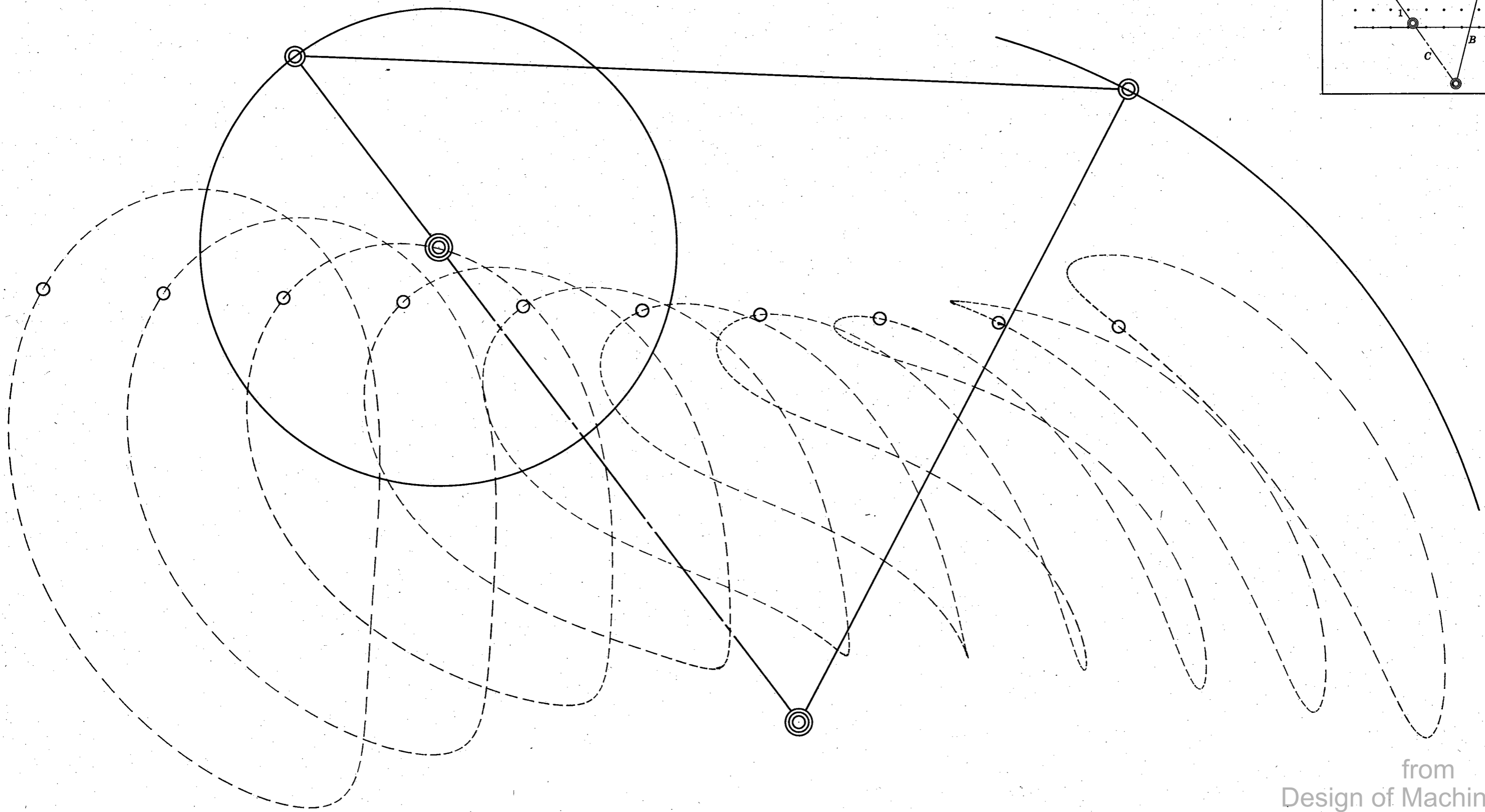
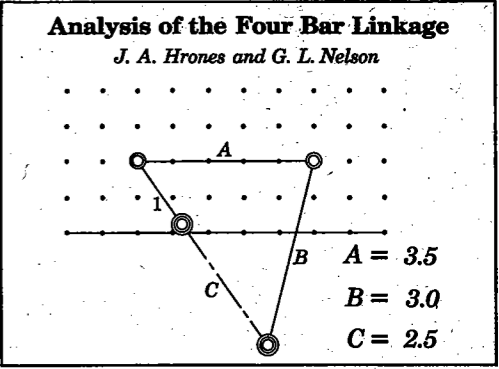

from  
 Design of Machinery 4ed  
 by Robert L. Norton  
 McGraw-Hill  
 Copyright 2008



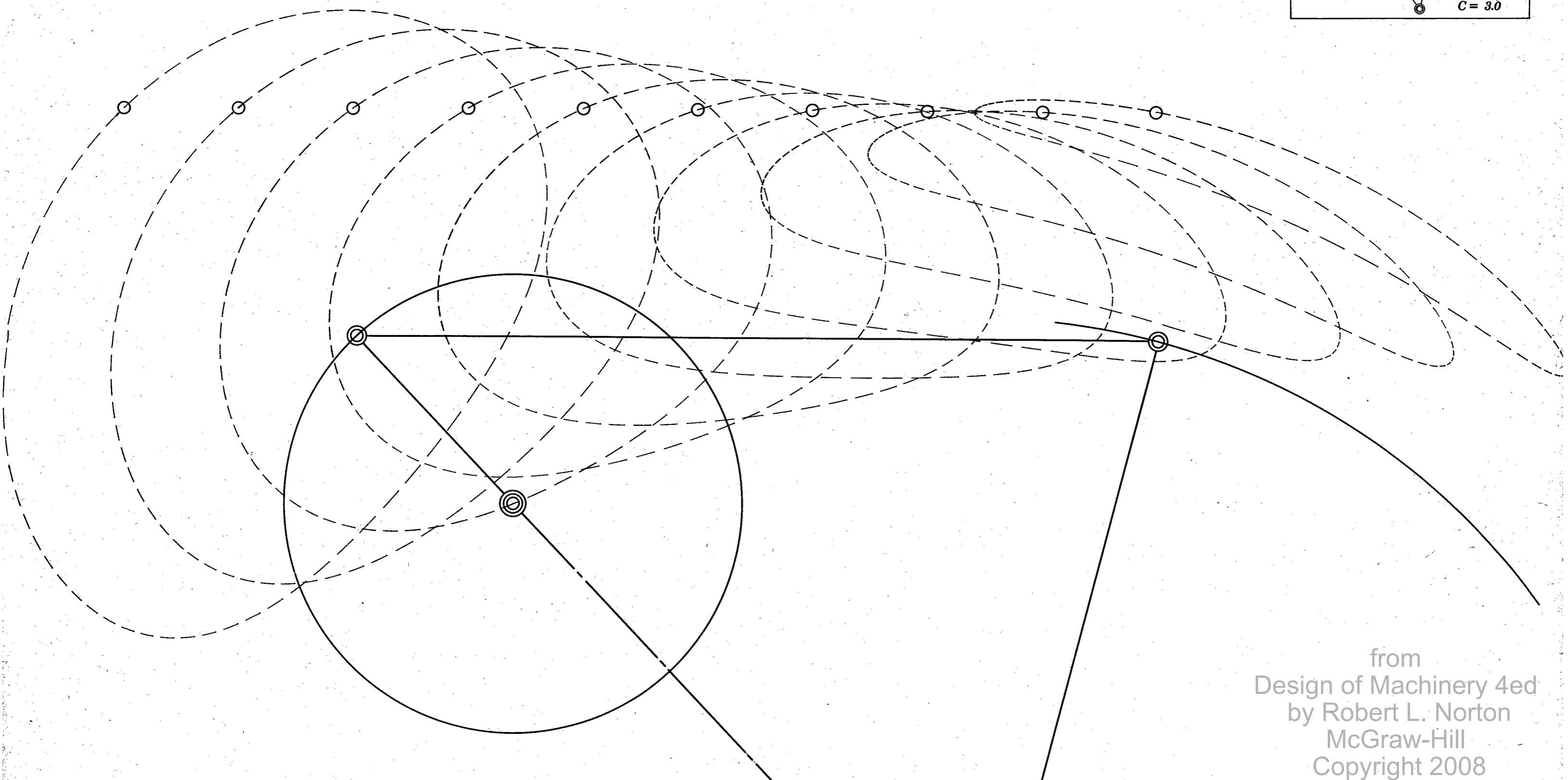
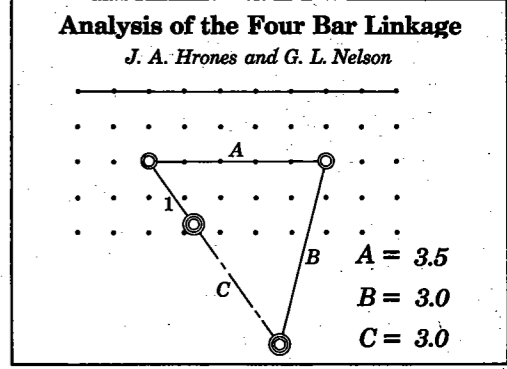

from  
Design of Machinery 4ed  
by Robert L. Norton  
McGraw-Hill  
Copyright 2008

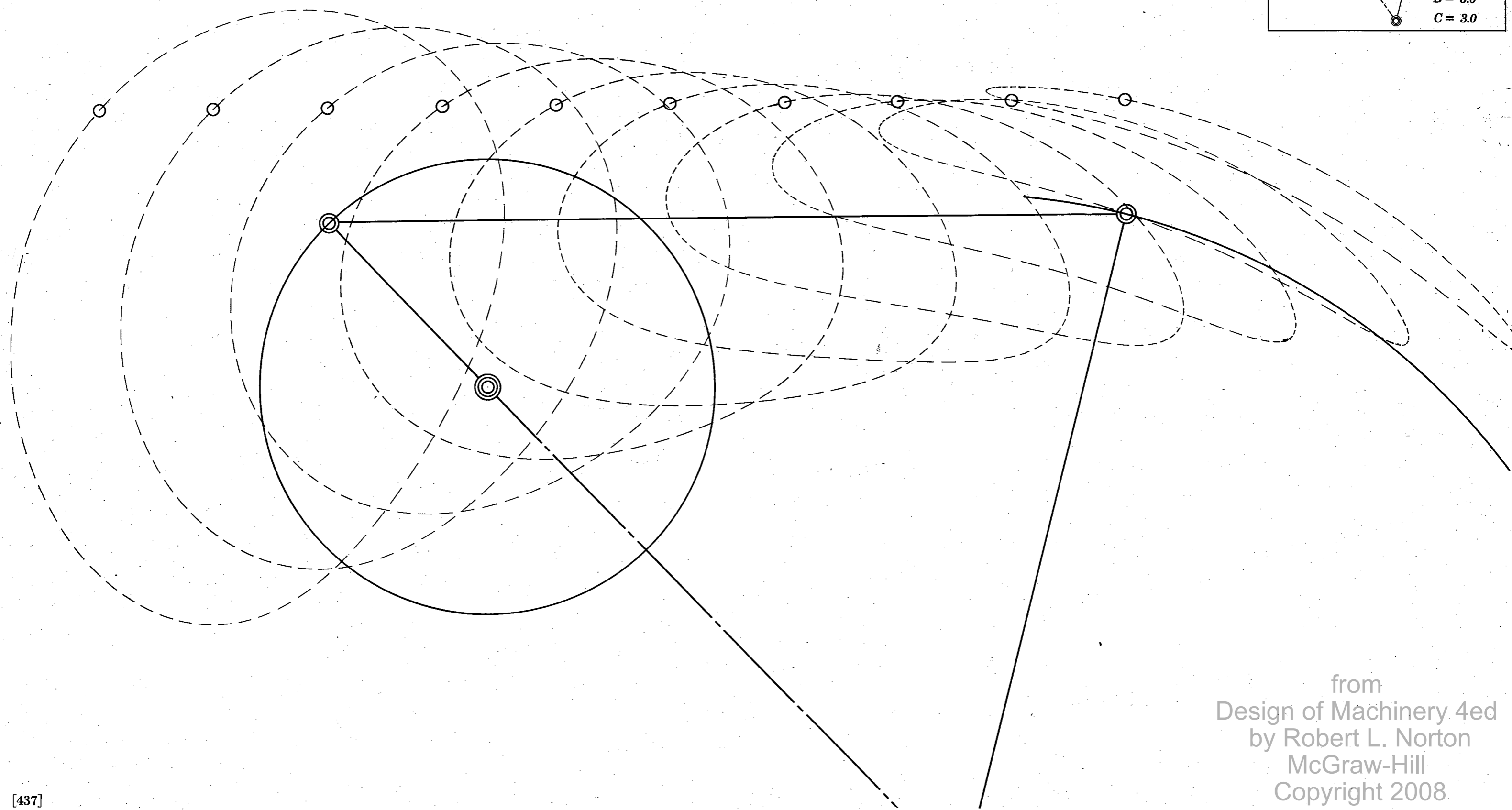
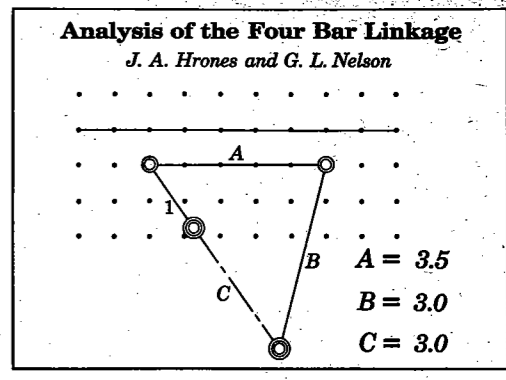

from  
 Design of Machinery 4ed  
 by Robert L. Norton  
 McGraw-Hill  
 Copyright 2008

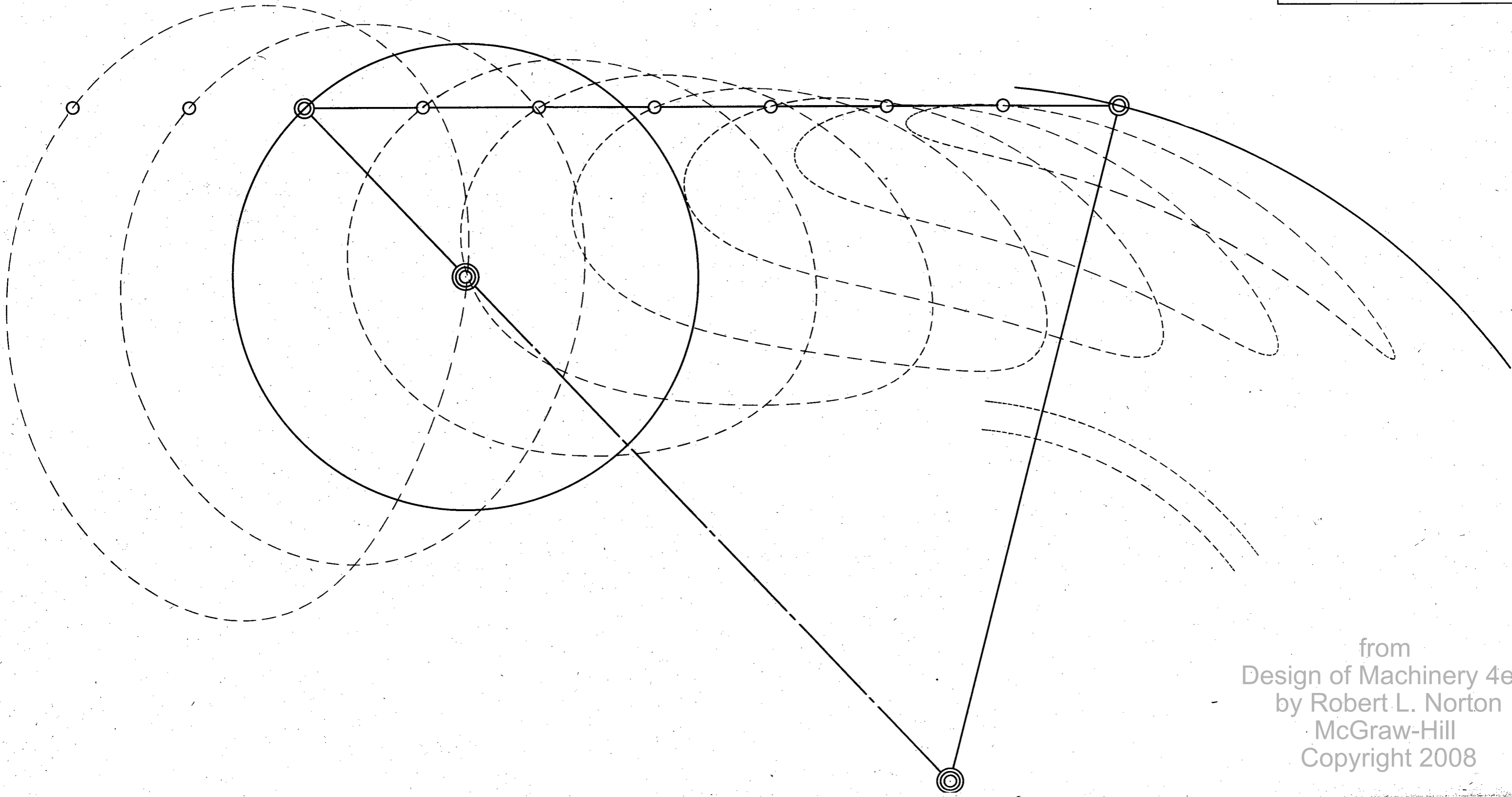
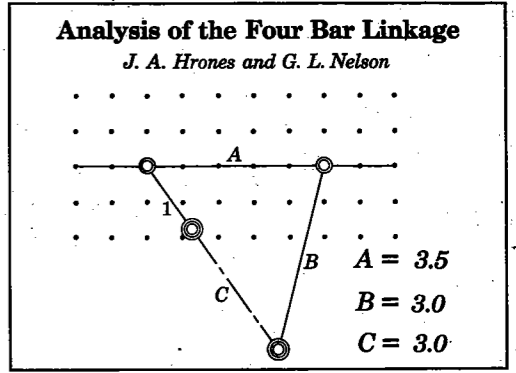

from  
Design of Machinery 4ed  
by Robert L. Norton  
McGraw-Hill  
Copyright 2008

**Analysis of the Four Bar Linkage**  
*J. A. Hrones and G. L. Nelson*

$A = 3.5$   
 $B = 3.0$   
 $C = 3.0$

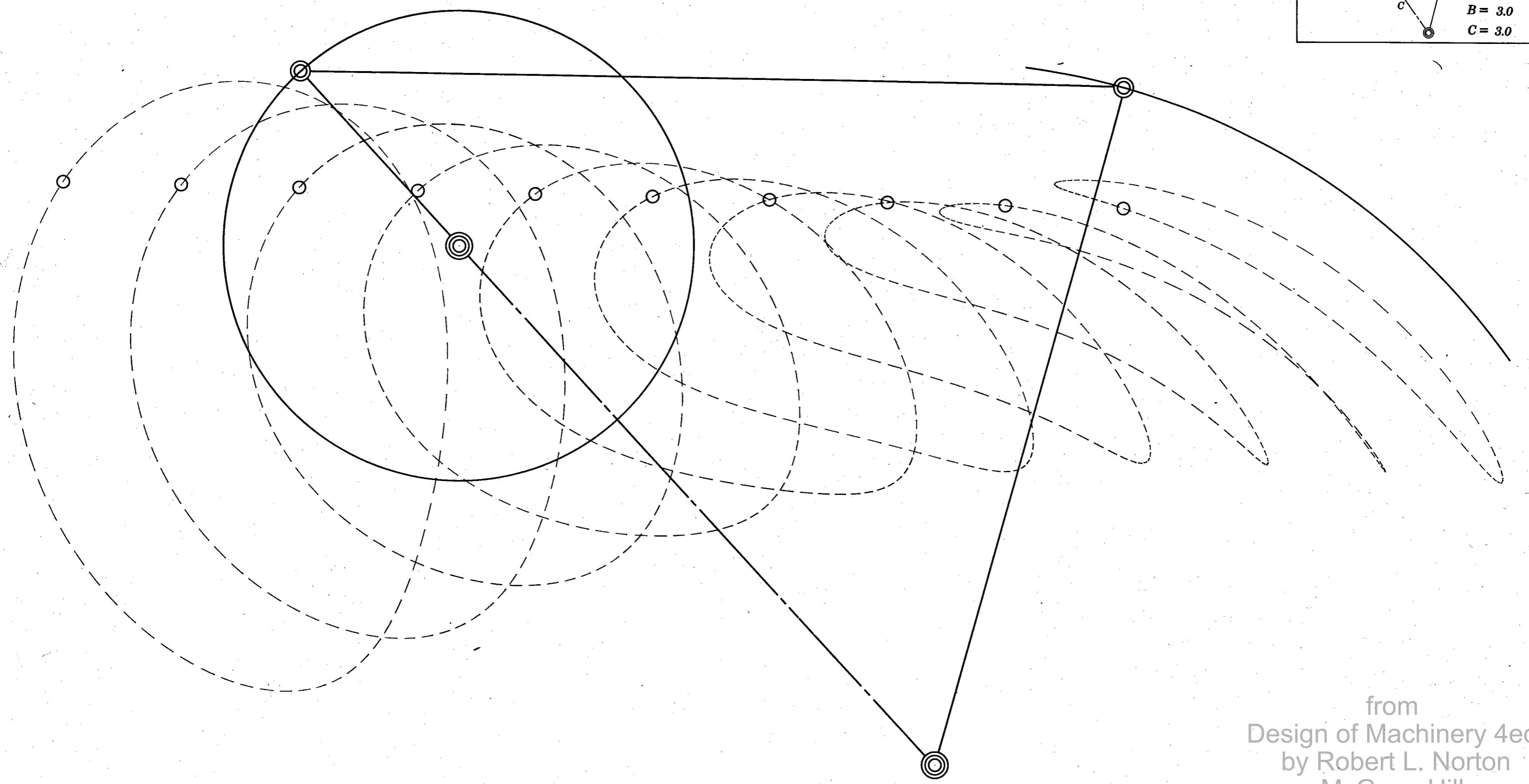

from  
 Design of Machinery 4ed  
 by Robert L. Norton  
 McGraw-Hill  
 Copyright 2008

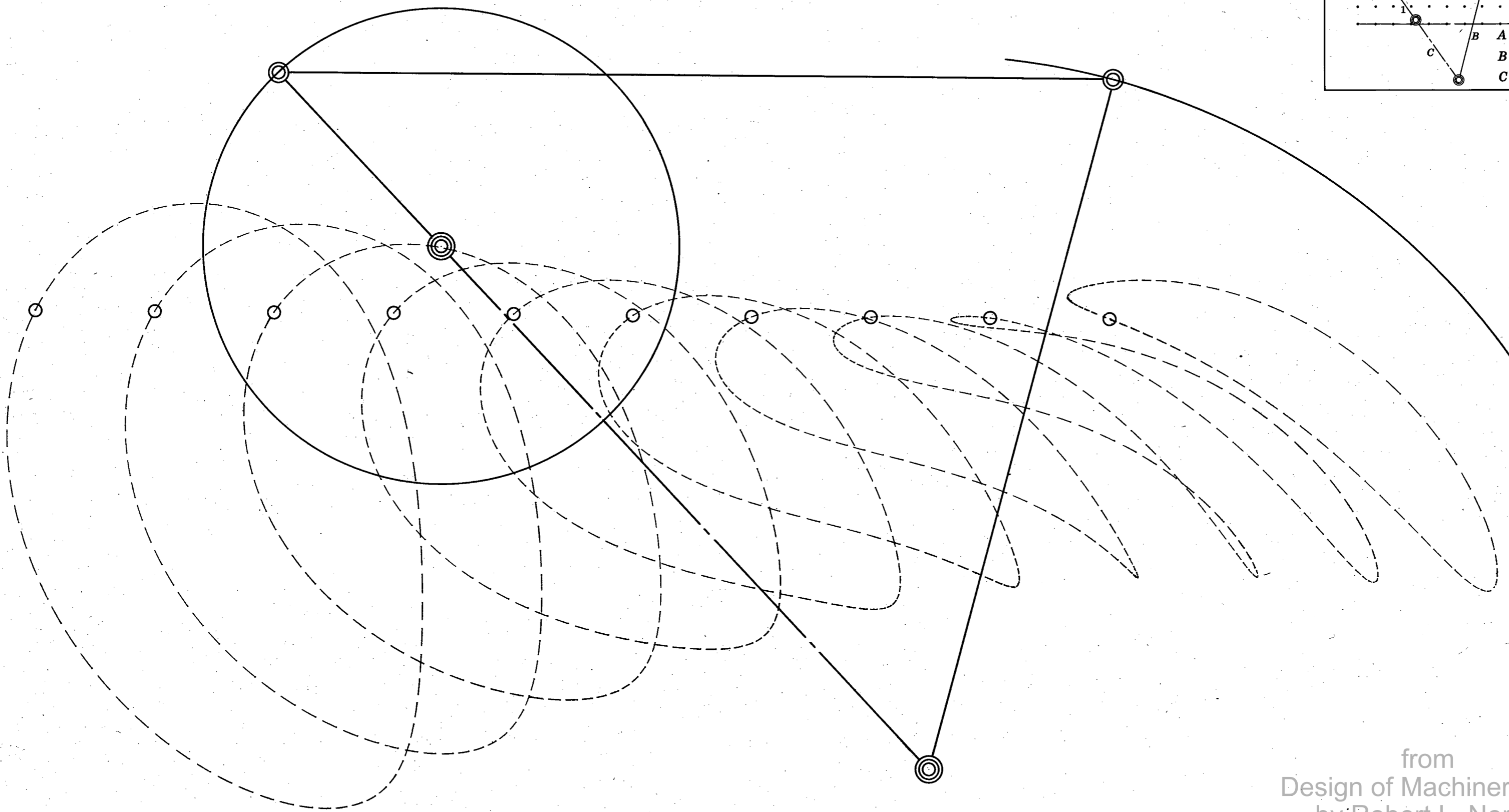
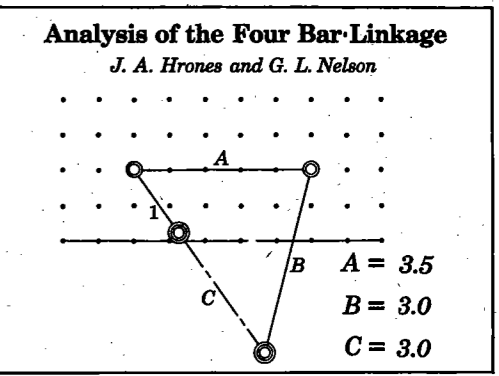

from  
Design of Machinery 4ed  
by Robert L. Norton  
McGraw-Hill  
Copyright 2008

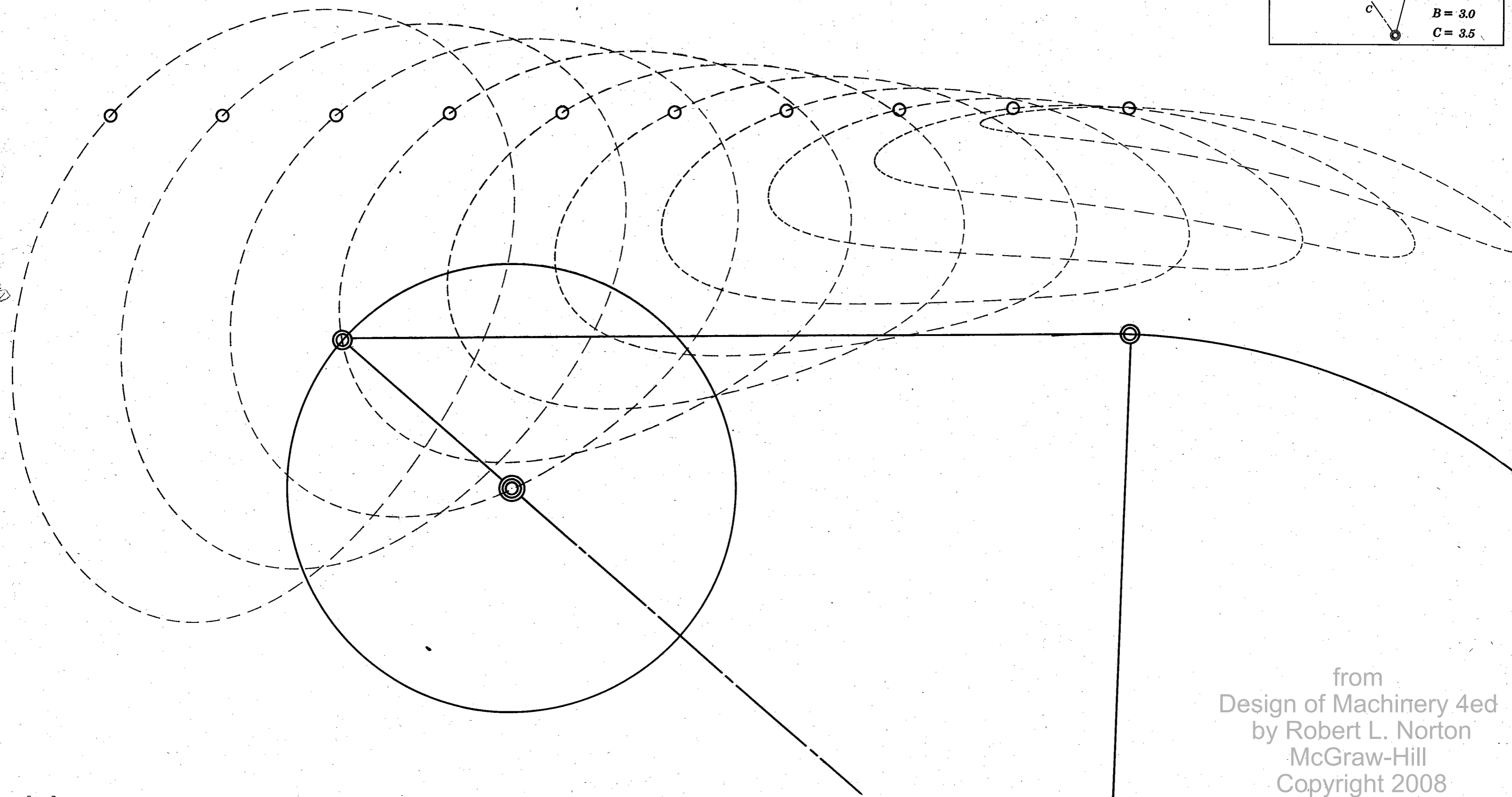
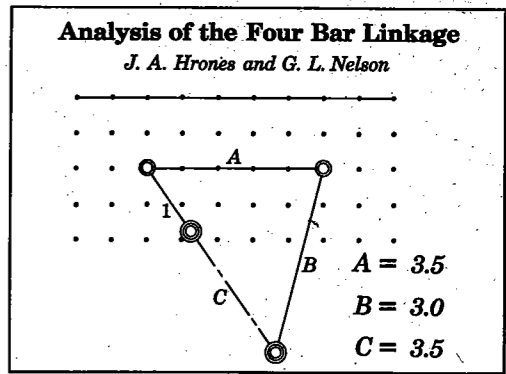

from  
 Design of Machinery 4ed  
 by Robert L. Norton  
 McGraw-Hill  
 Copyright 2008

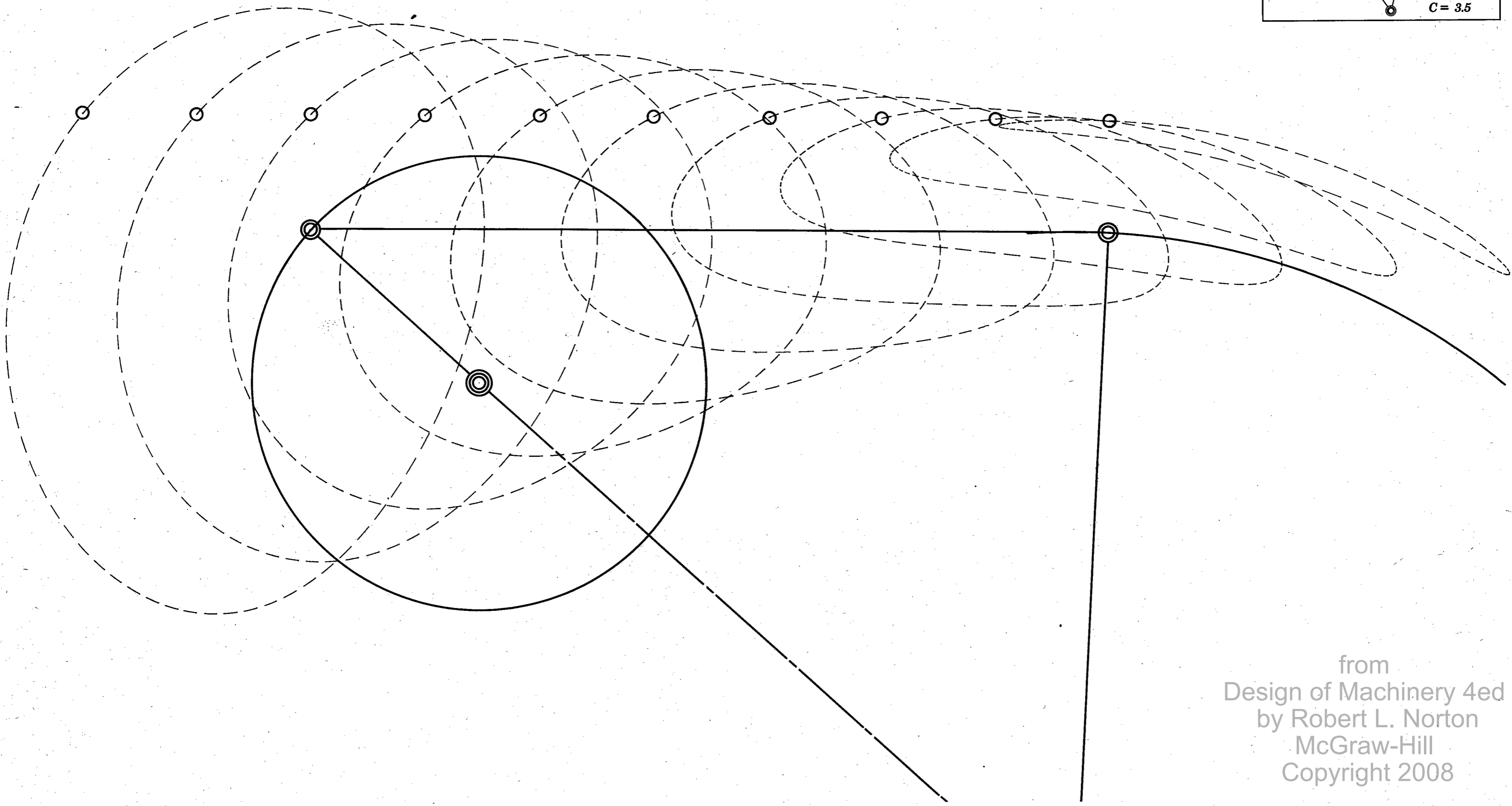
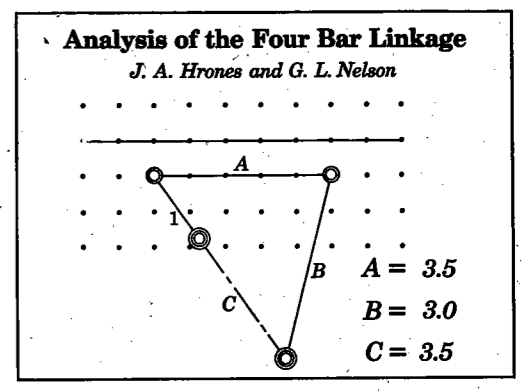

from  
Design of Machinery 4ed  
by Robert L. Norton  
McGraw-Hill  
Copyright 2008

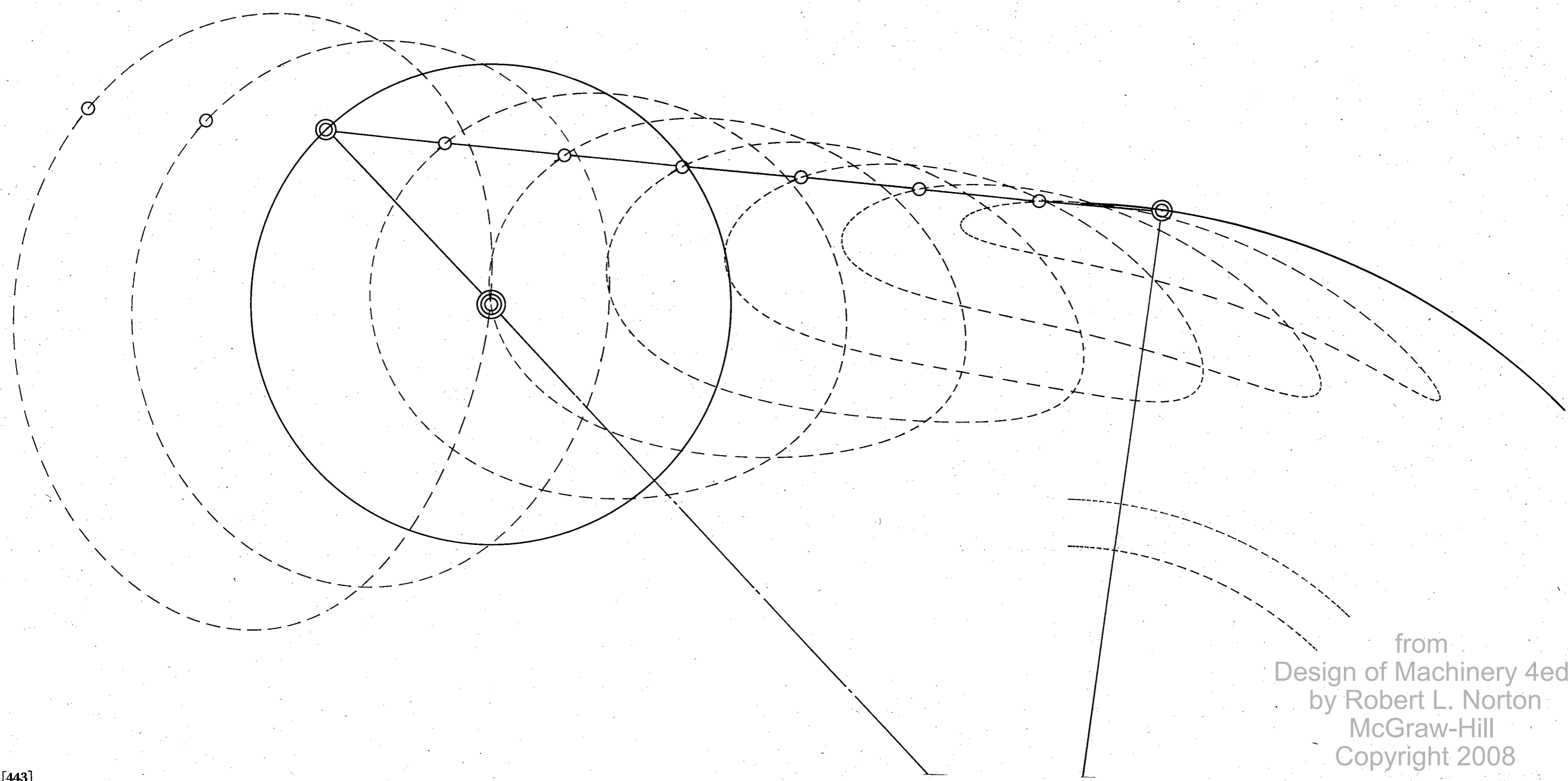
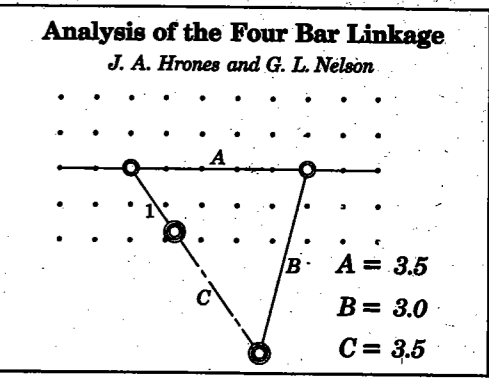

from  
 Design of Machinery 4ed  
 by Robert L. Norton  
 McGraw-Hill  
 Copyright 2008



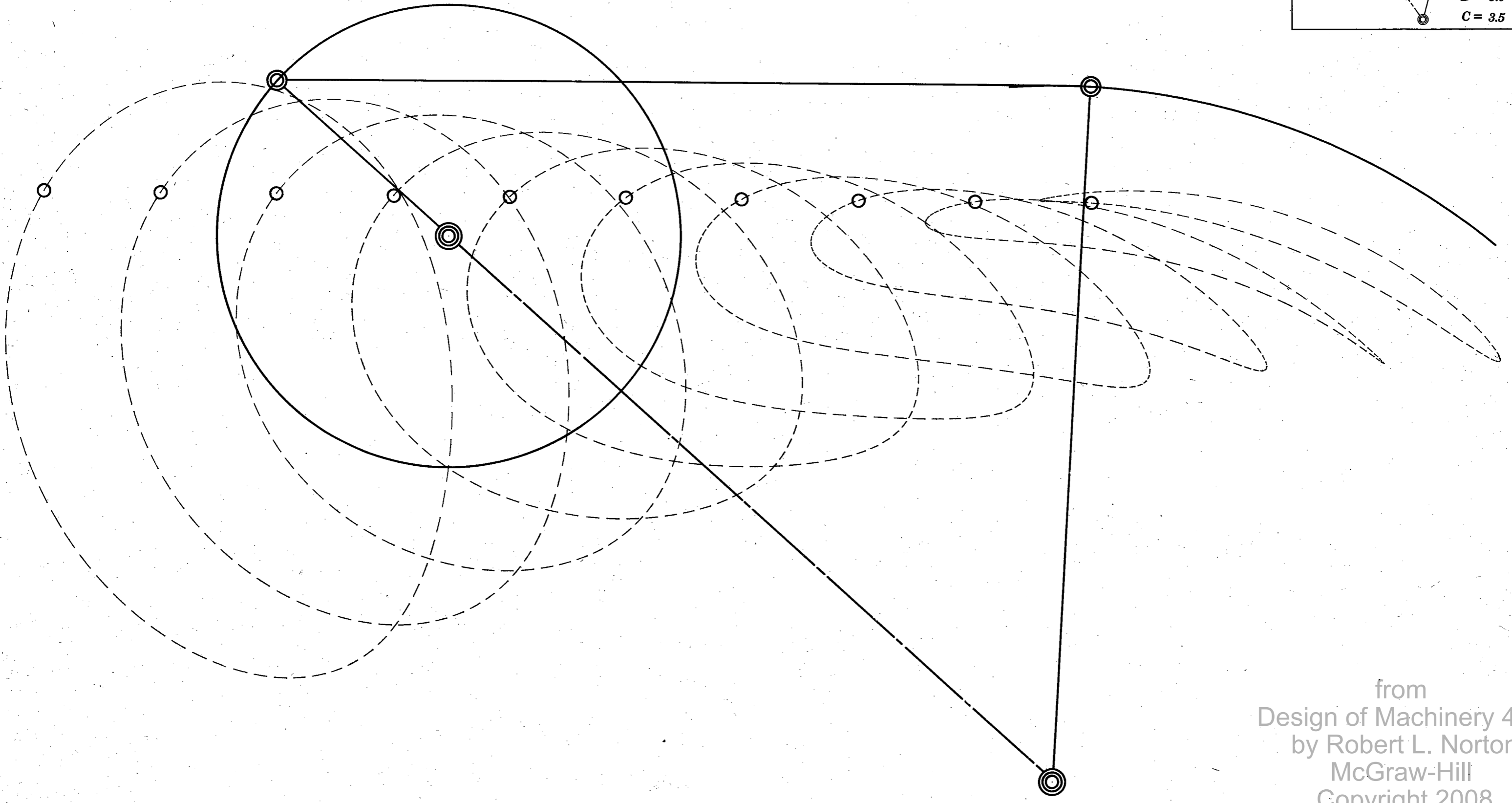
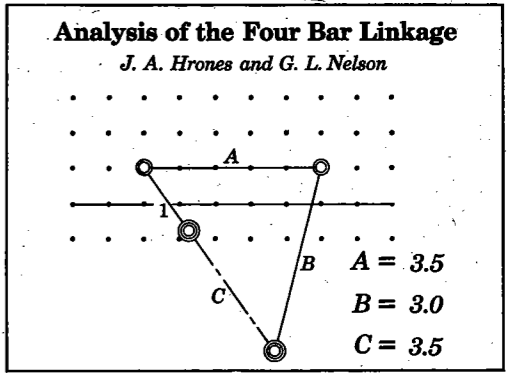

from  
Design of Machinery 4ed  
by Robert L. Norton  
McGraw-Hill  
Copyright 2008

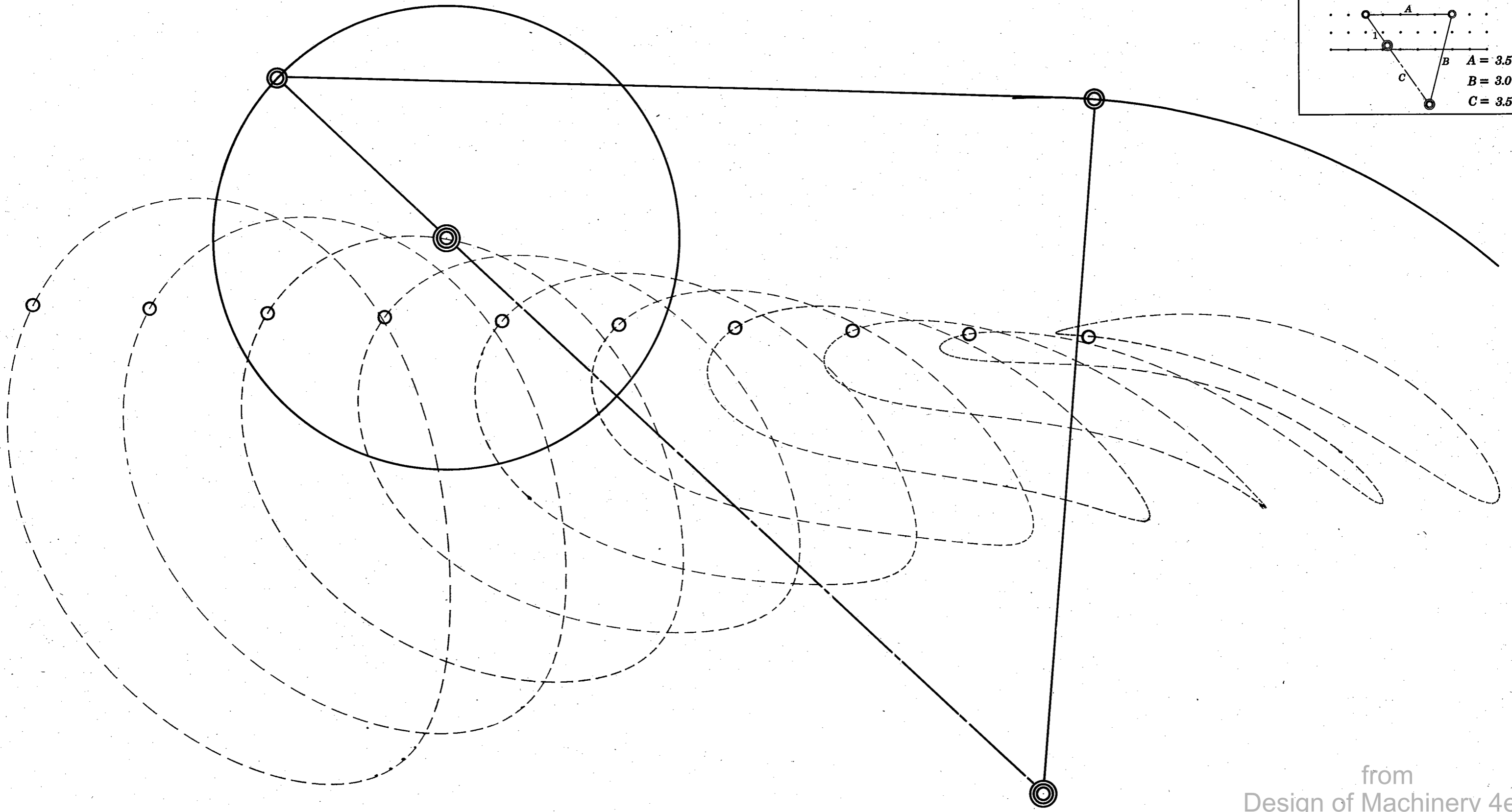
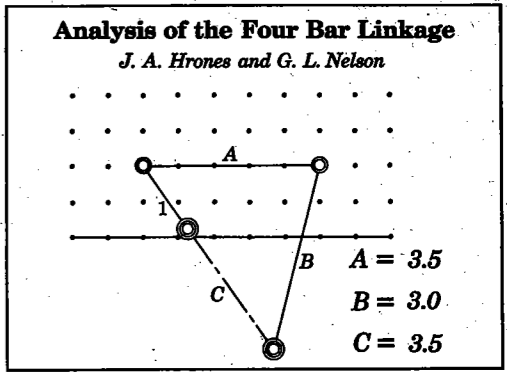

from  
 Design of Machinery 4ed  
 by Robert L. Norton  
 McGraw-Hill  
 Copyright 2008

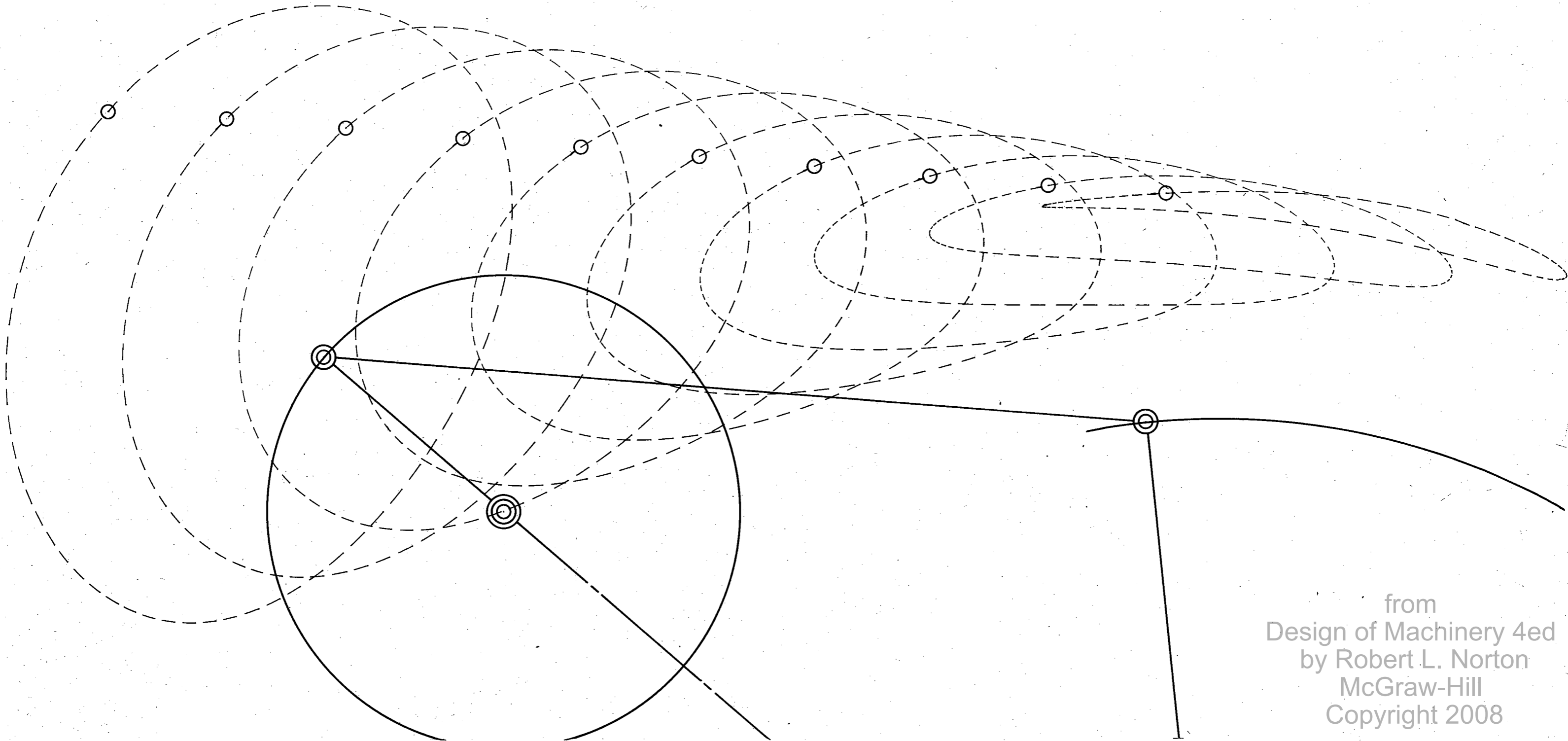
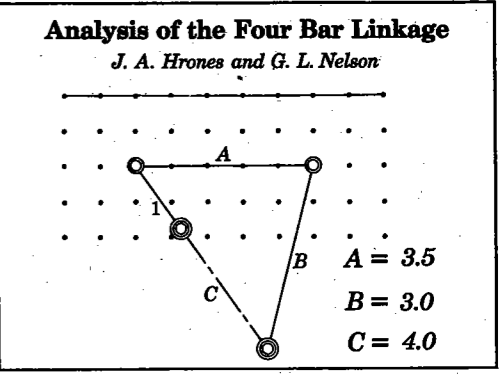

from  
Design of Machinery 4ed  
by Robert L. Norton  
McGraw-Hill  
Copyright 2008

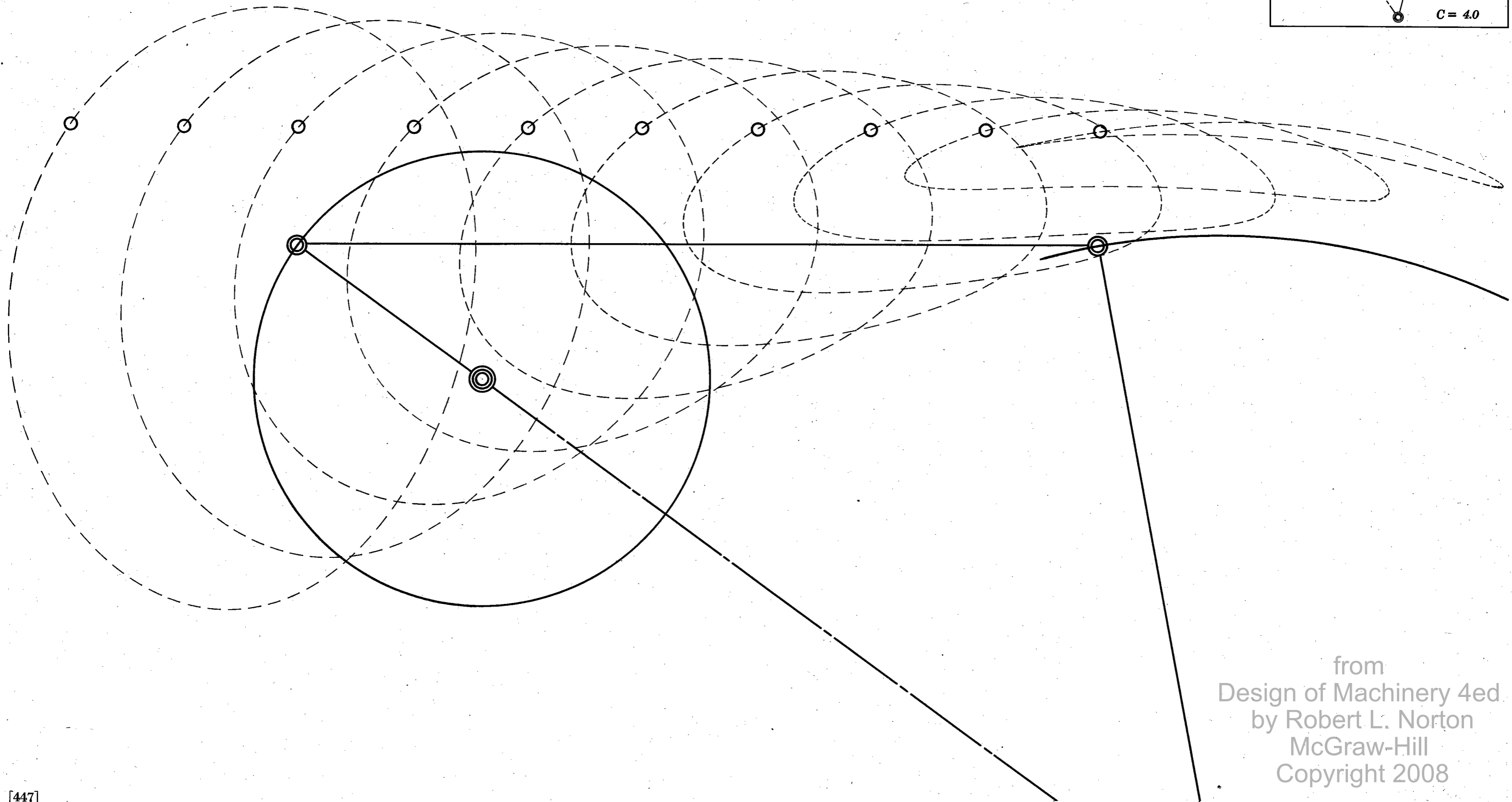
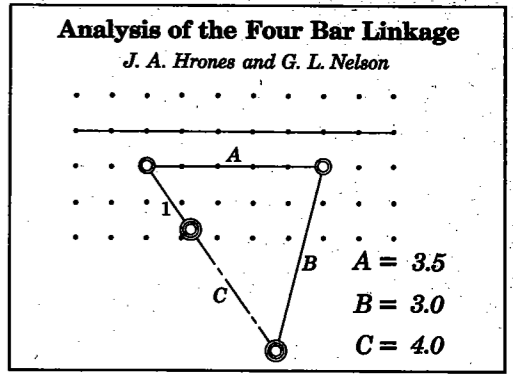

from  
 Design of Machinery 4ed.  
 by Robert L. Norton  
 McGraw-Hill  
 Copyright 2008

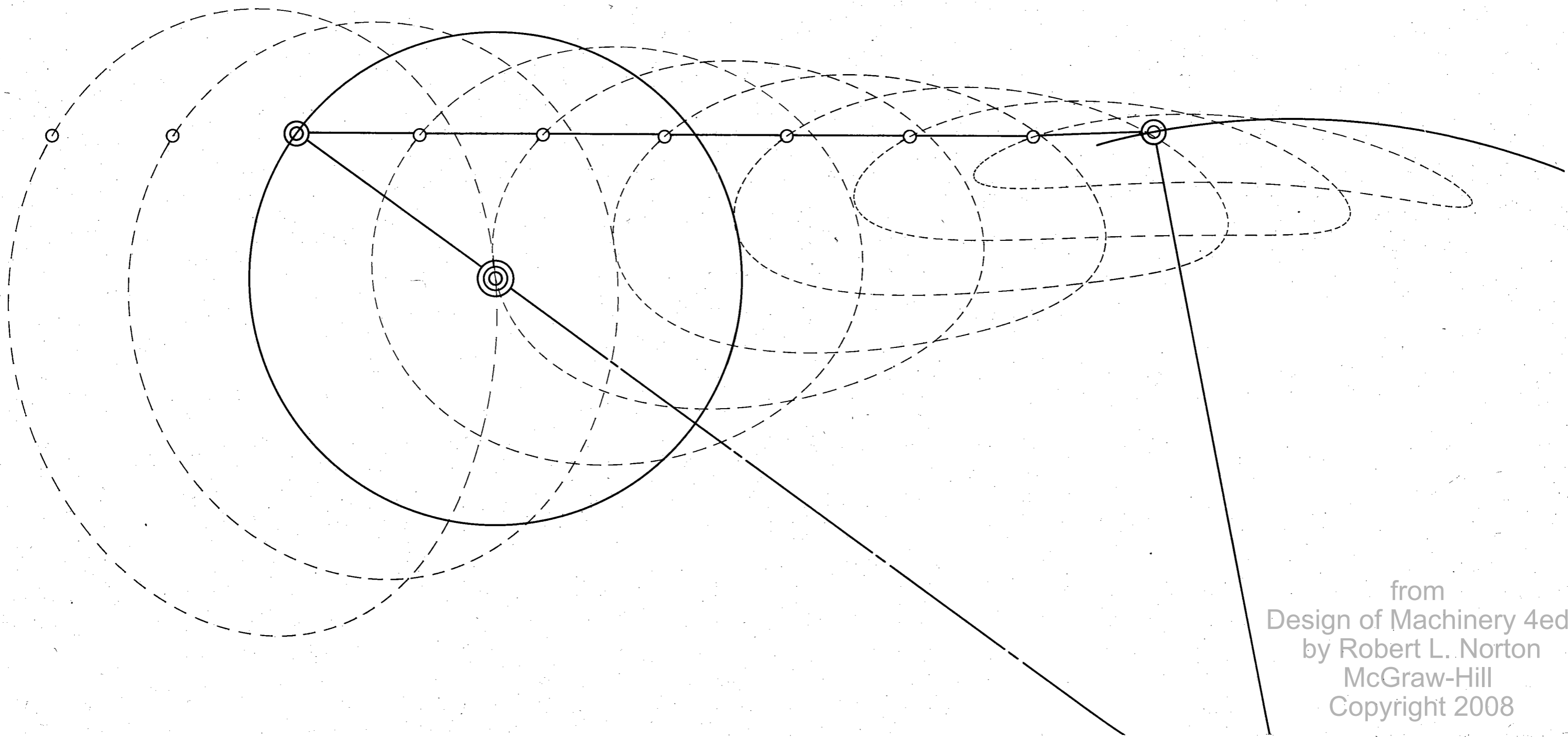
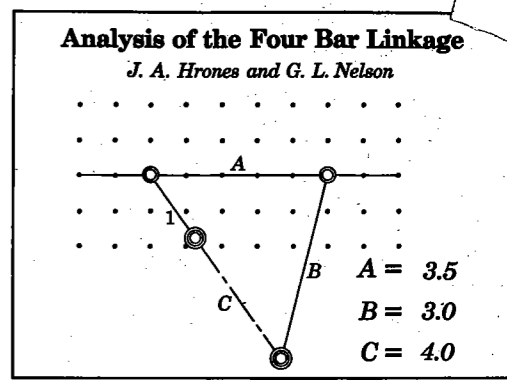

from  
Design of Machinery 4ed  
by Robert L. Norton  
McGraw-Hill  
Copyright 2008

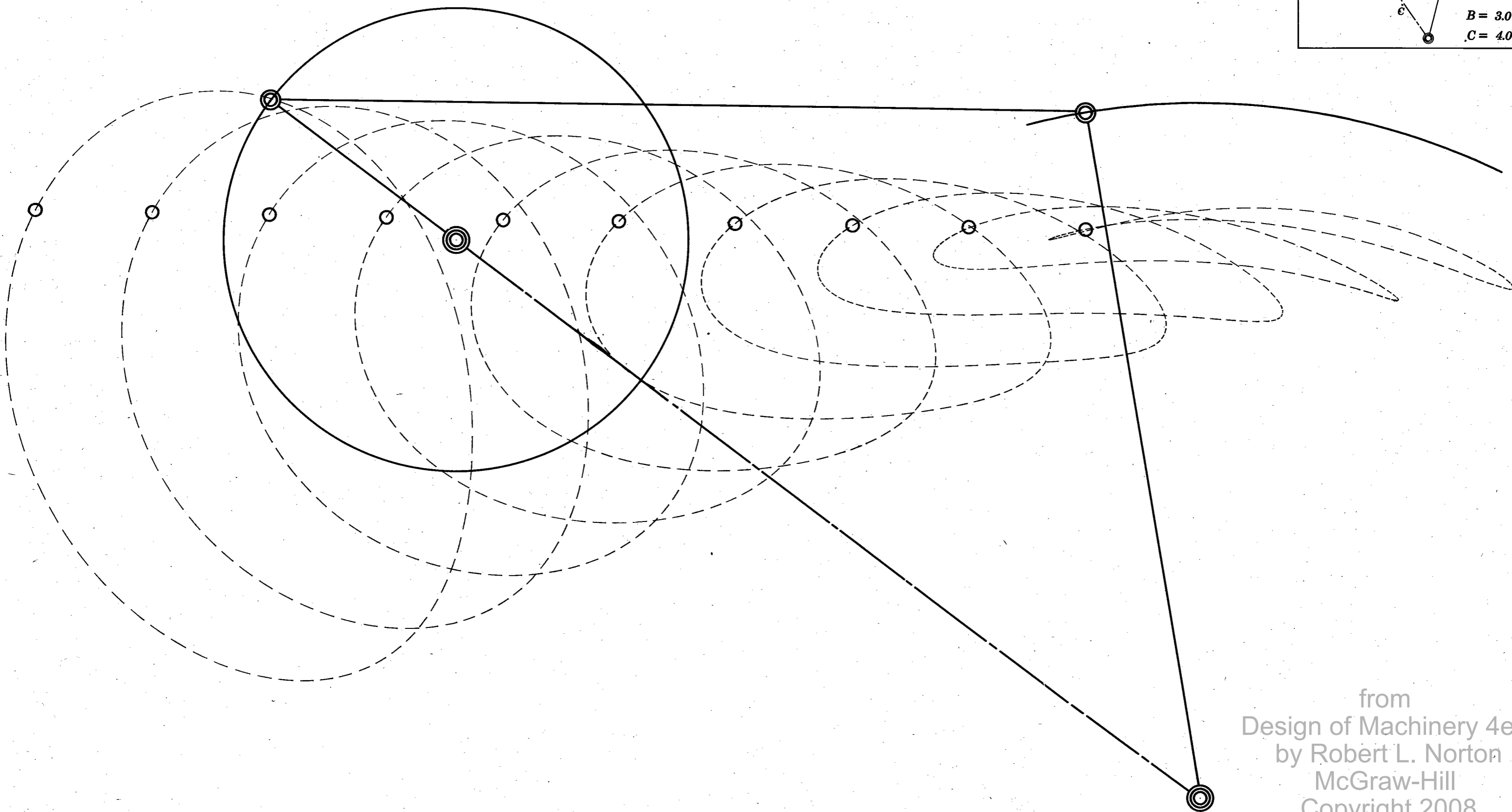
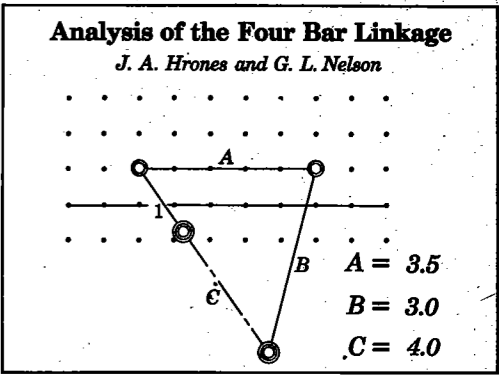

from  
 Design of Machinery 4ed  
 by Robert L. Norton  
 McGraw-Hill  
 Copyright 2008

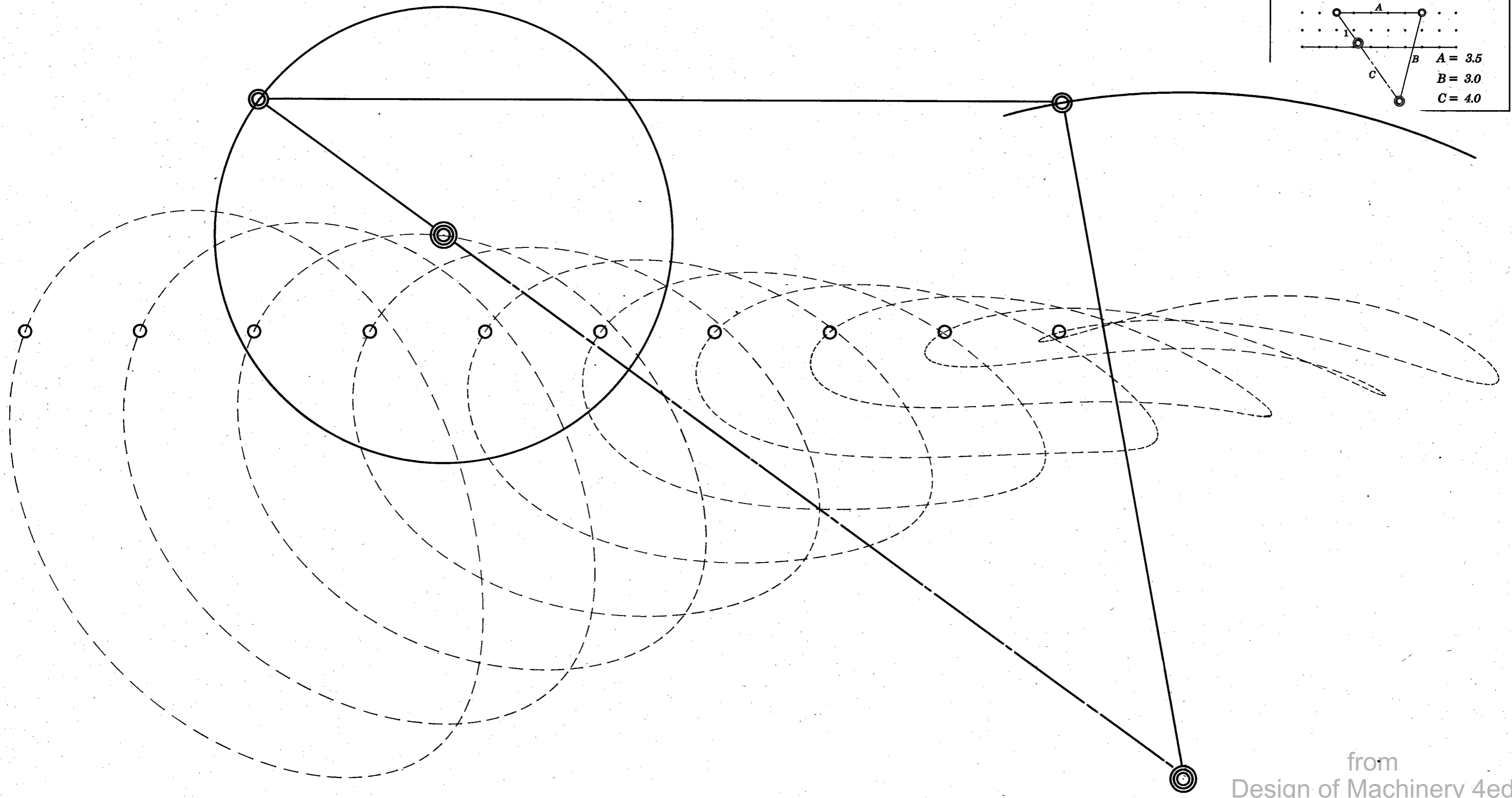
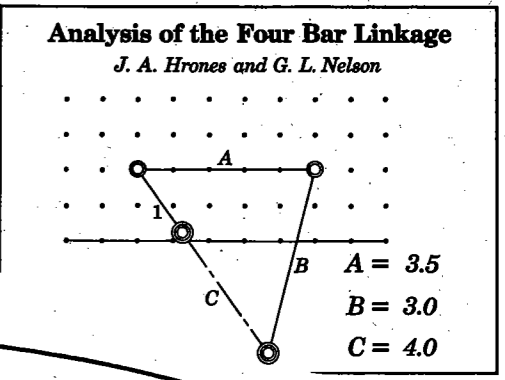

from  
Design of Machinery 4ed  
by Robert L. Norton  
McGraw-Hill  
Copyright 2008

**Analysis of the Four Bar Linkage**  
*J. A. Hrones and G. L. Nelson*

$A = 3.5$   
 $B = 3.0$   
 $C = 4.5$

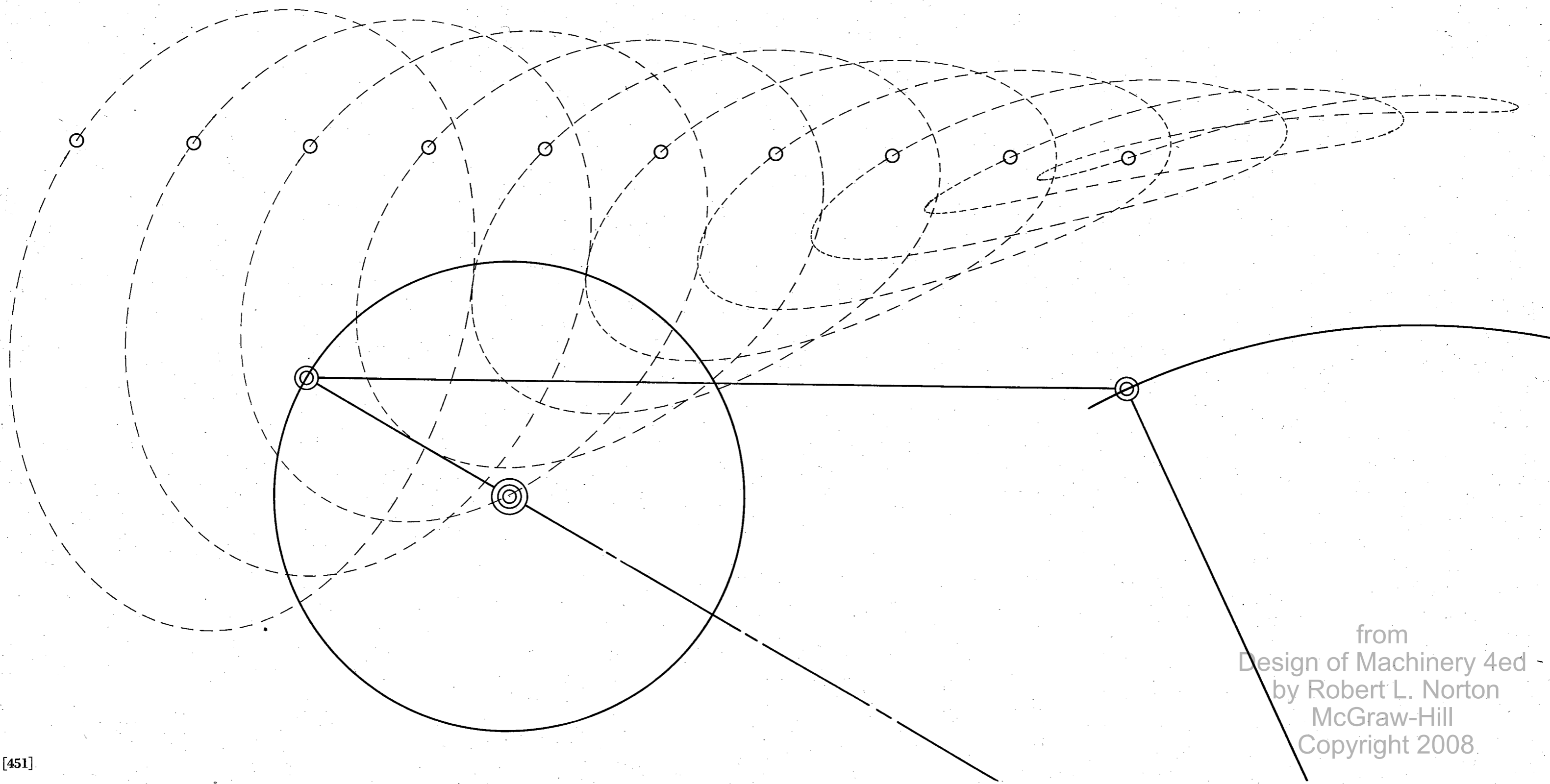

from  
 Design of Machinery 4ed  
 by Robert L. Norton  
 McGraw-Hill  
 Copyright 2008



**Analysis of the Four Bar Linkage**  
*J. A. Hrones and G. L. Nelson*

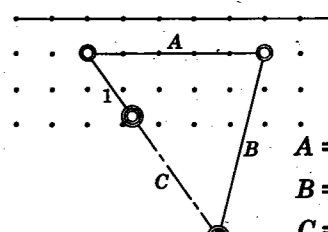

$A = 3.5$   
 $B = 3.0$   
 $C = 4.5$

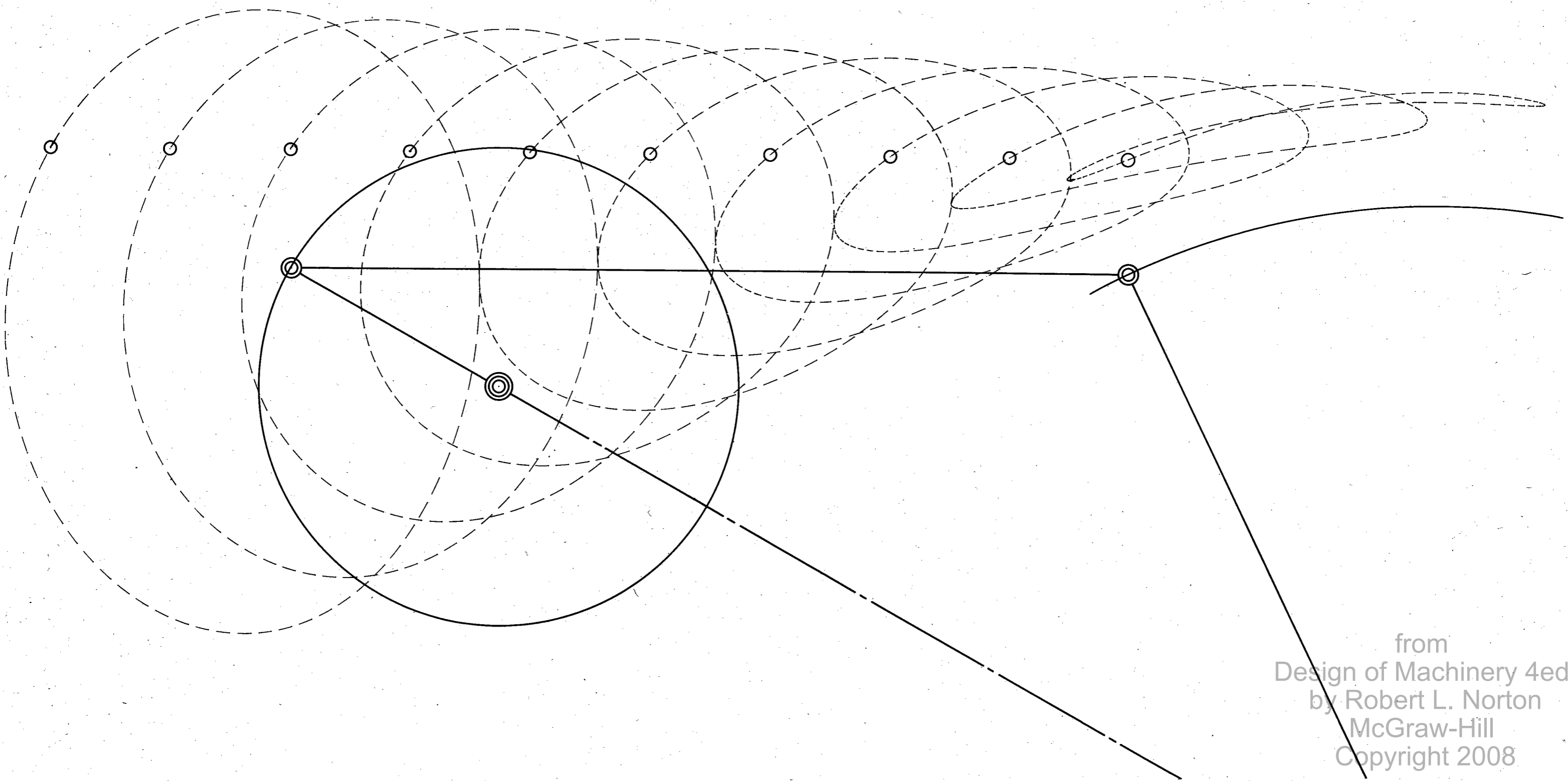

from  
Design of Machinery 4ed  
by Robert L. Norton  
McGraw-Hill  
Copyright 2008

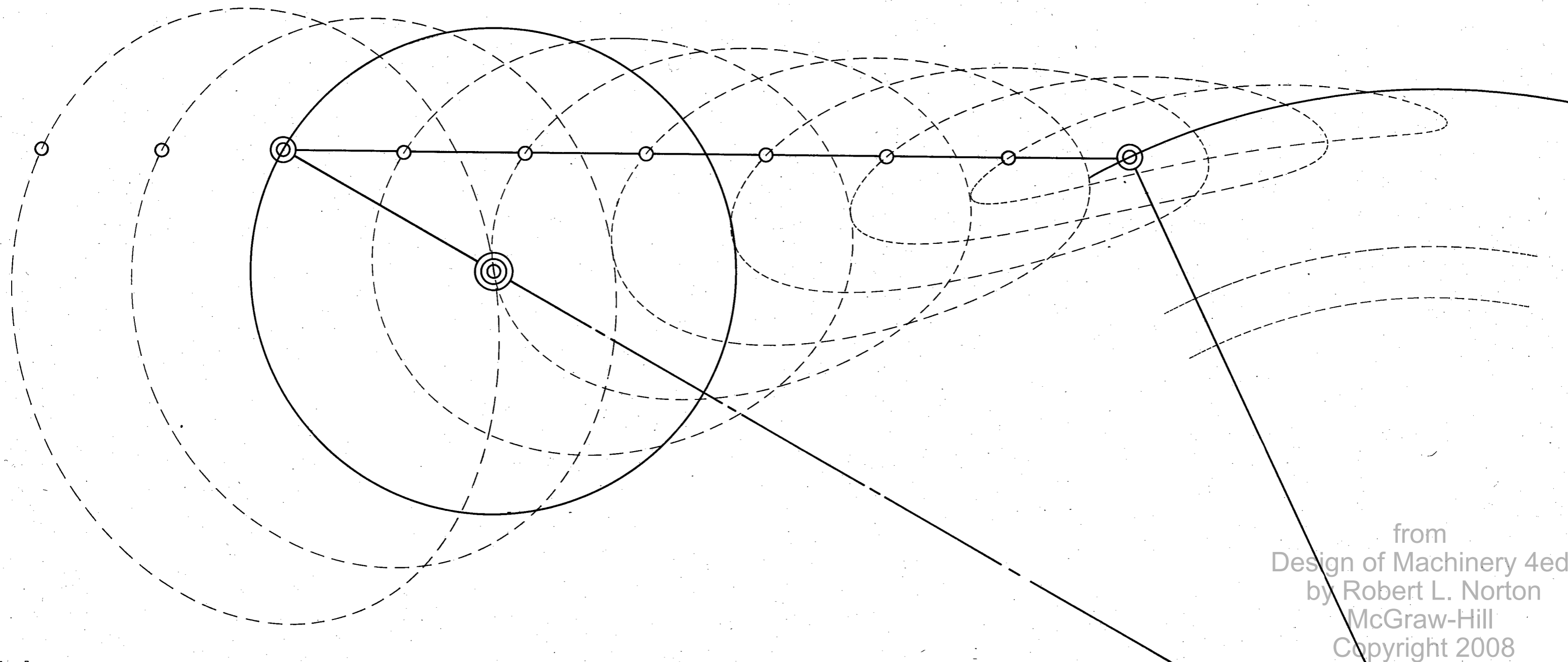
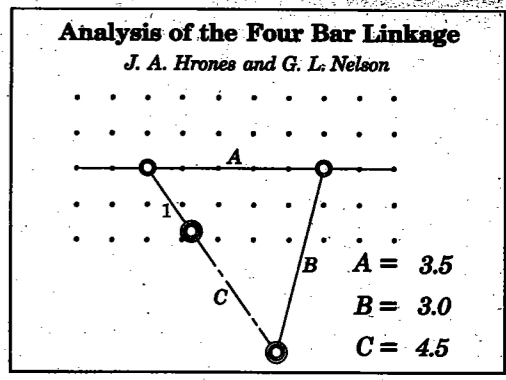

from  
 Design of Machinery 4ed  
 by Robert L. Norton  
 McGraw-Hill  
 Copyright 2008

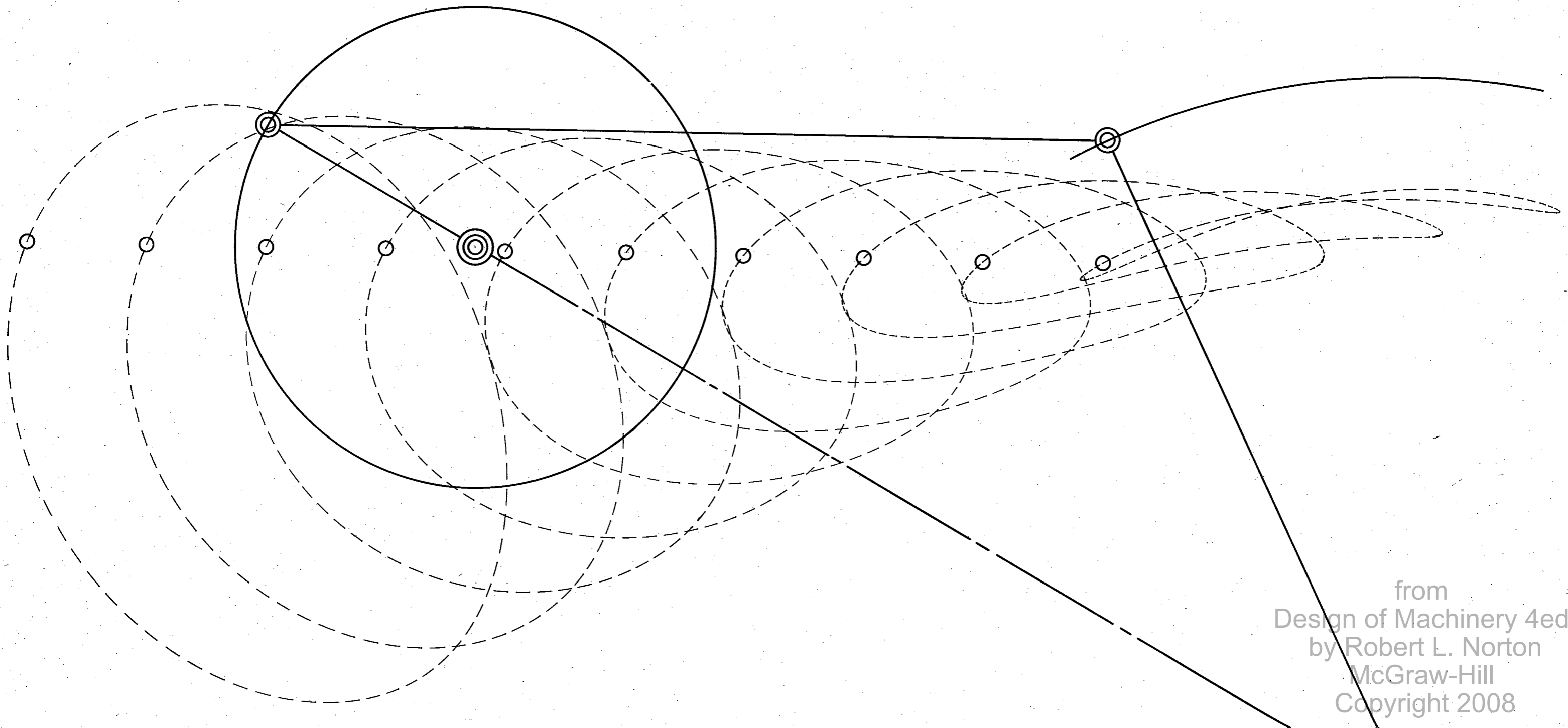
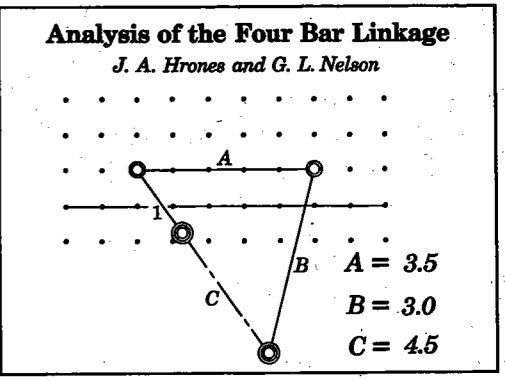

from  
Design of Machinery 4ed  
by Robert L. Norton  
McGraw-Hill  
Copyright 2008

Analysis of the Four Bar Linkage

J. A. Hrones and G. L. Nelson

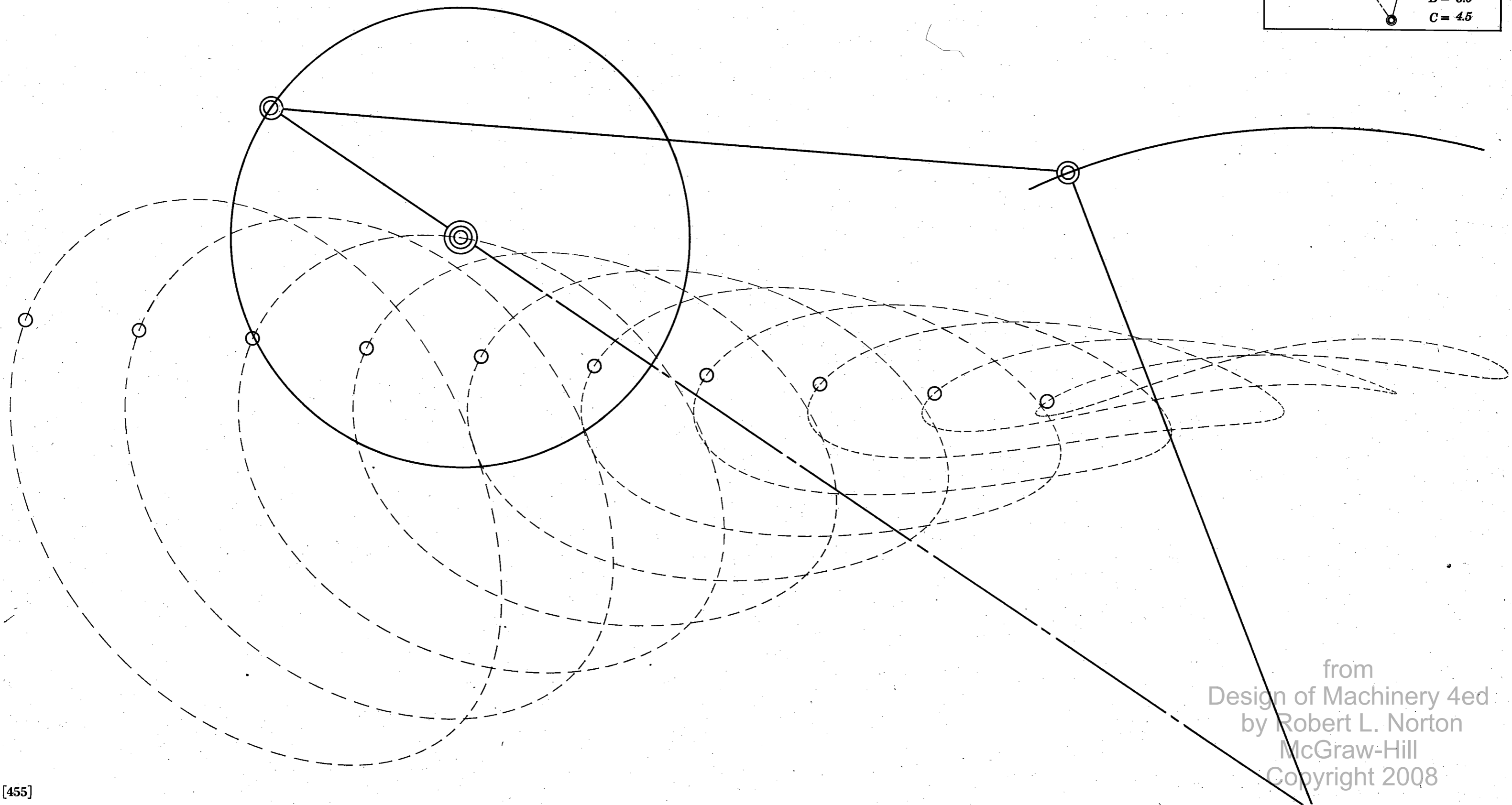
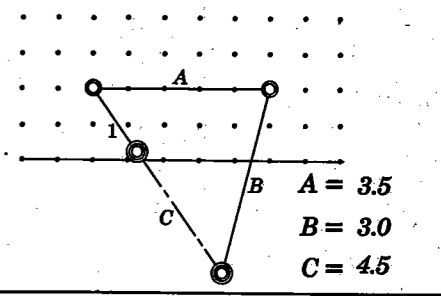

from  
Design of Machinery 4ed  
by Robert L. Norton  
McGraw-Hill  
Copyright 2008

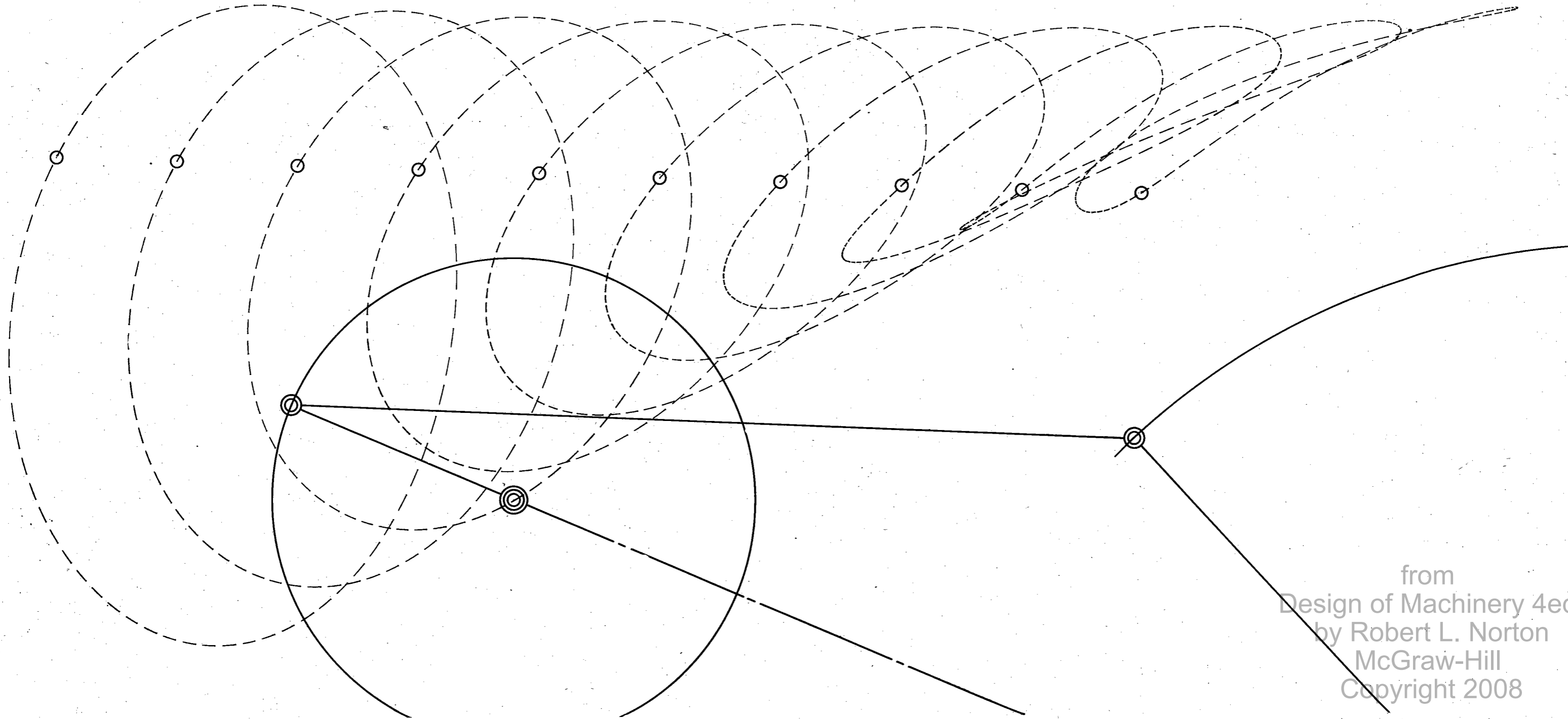
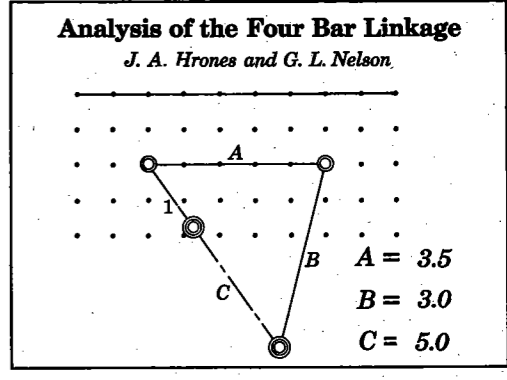

from  
Design of Machinery 4ed  
by Robert L. Norton  
McGraw-Hill  
Copyright 2008

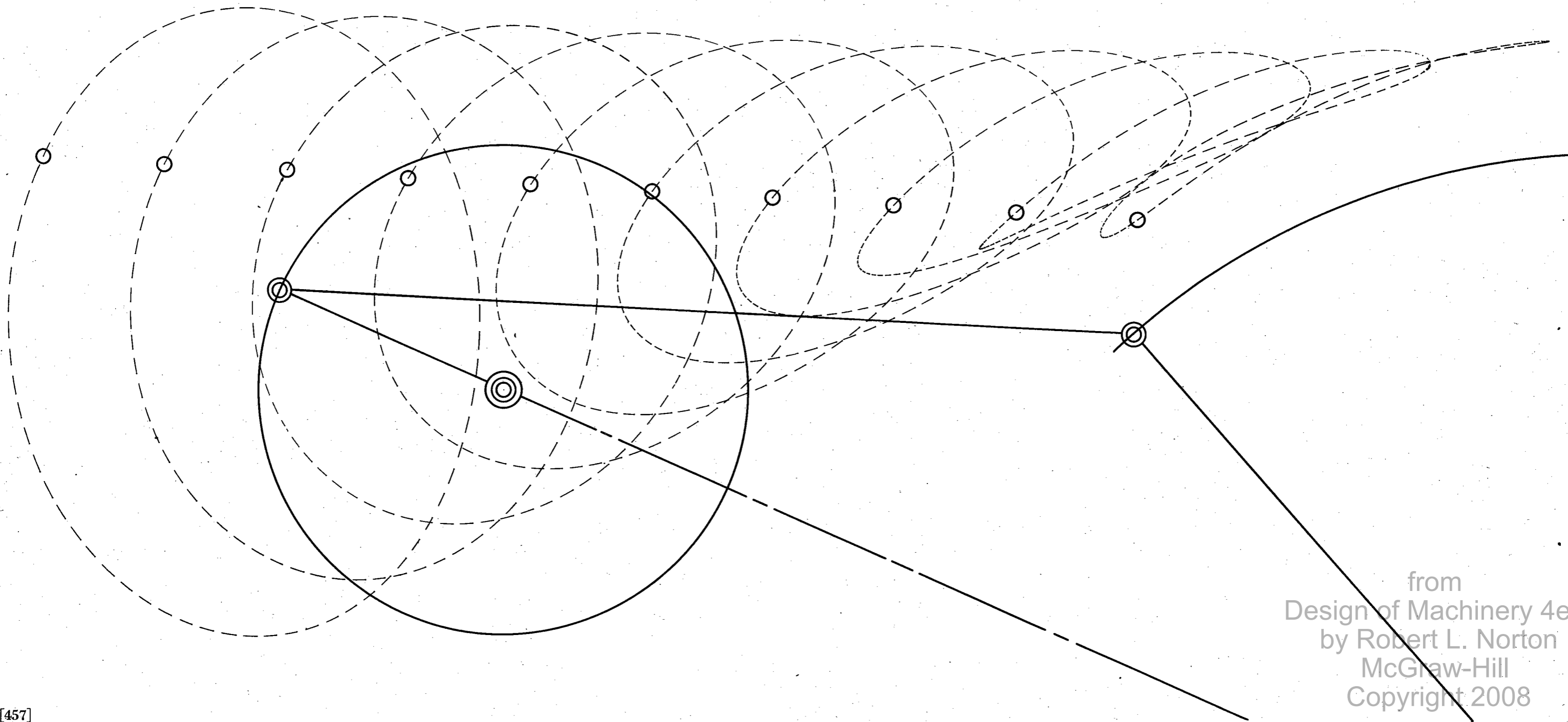
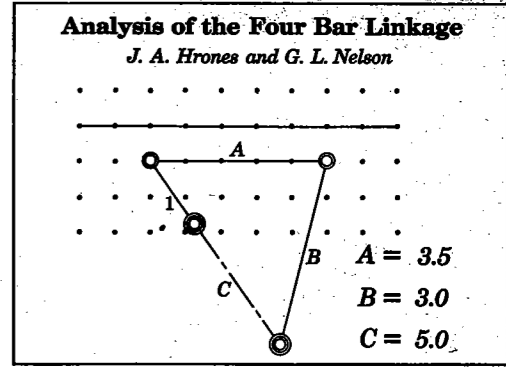

from  
 Design of Machinery 4ed  
 by Robert L. Norton  
 McGraw-Hill  
 Copyright 2008

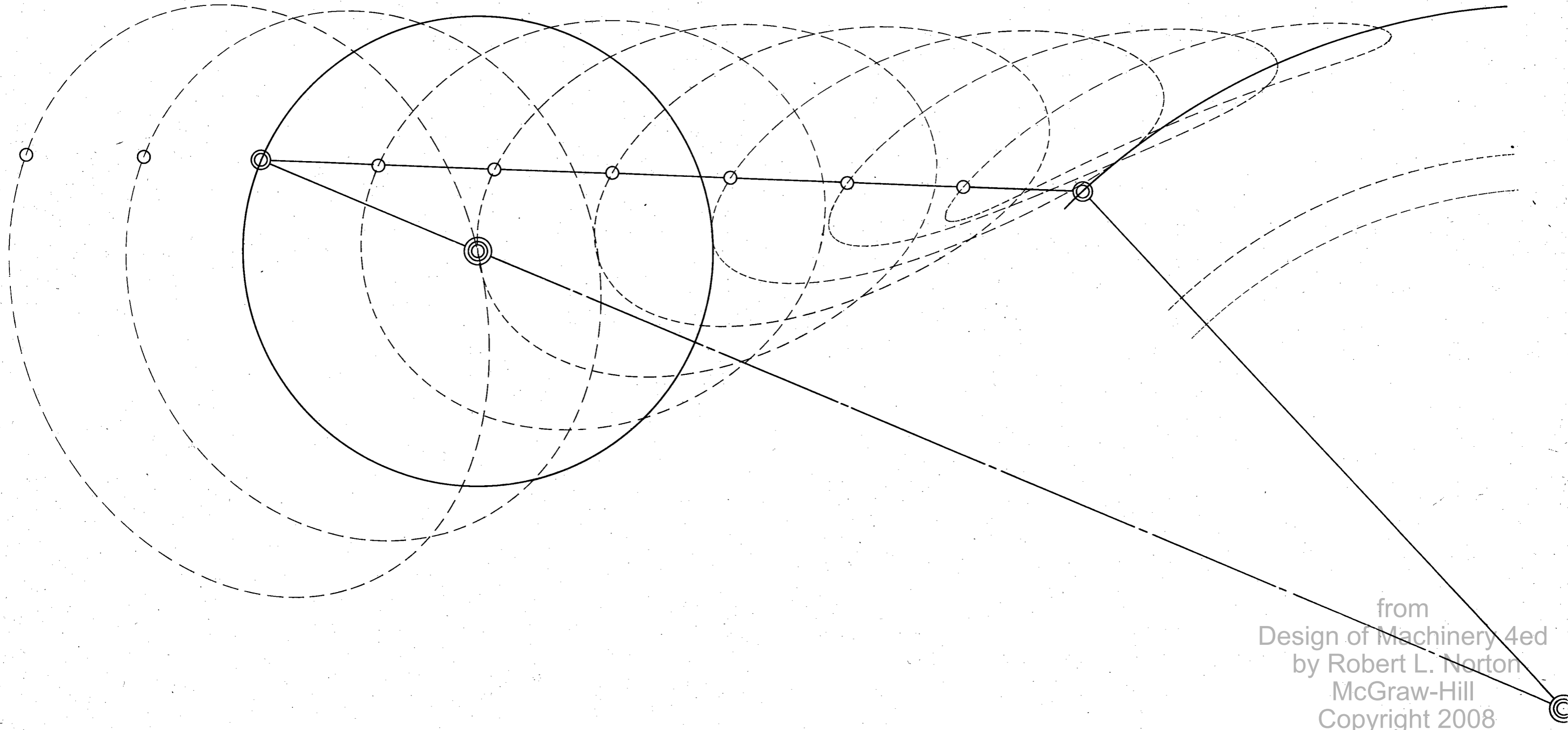
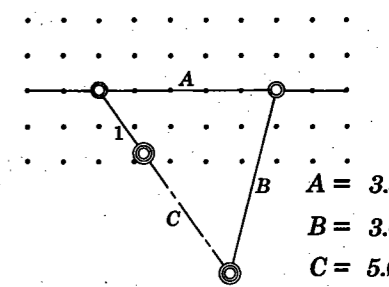

from  
Design of Machinery 4ed  
by Robert L. Norton  
McGraw-Hill  
Copyright 2008

**Analysis of the Four Bar Linkage**  
*J. A. Hrones and G. L. Nelson*

$A = 3.5$   
 $B = 3.0$   
 $C = 5.0$

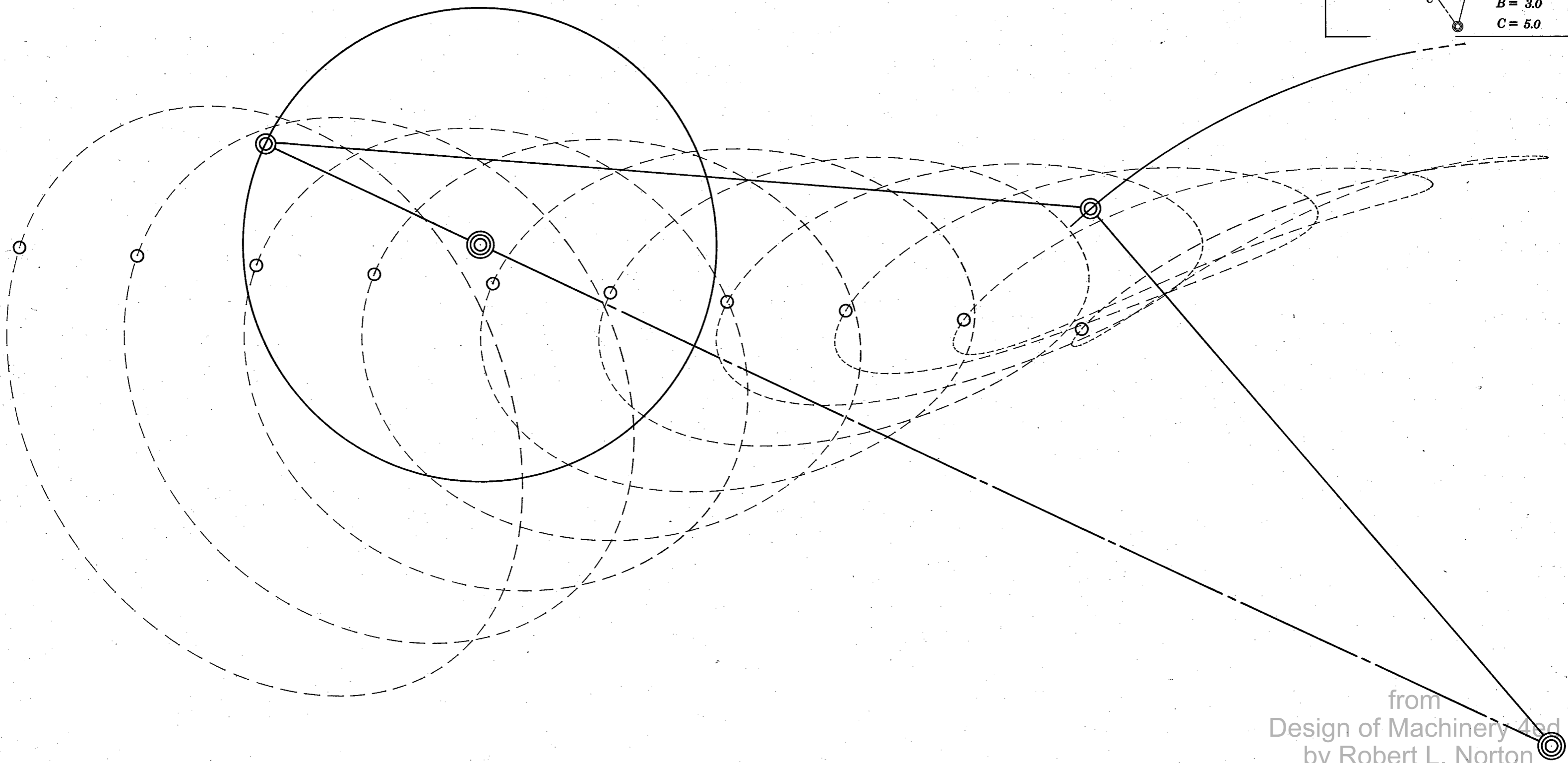

from  
 Design of Machinery 4th  
 by Robert L. Norton  
 McGraw-Hill  
 Copyright 2008



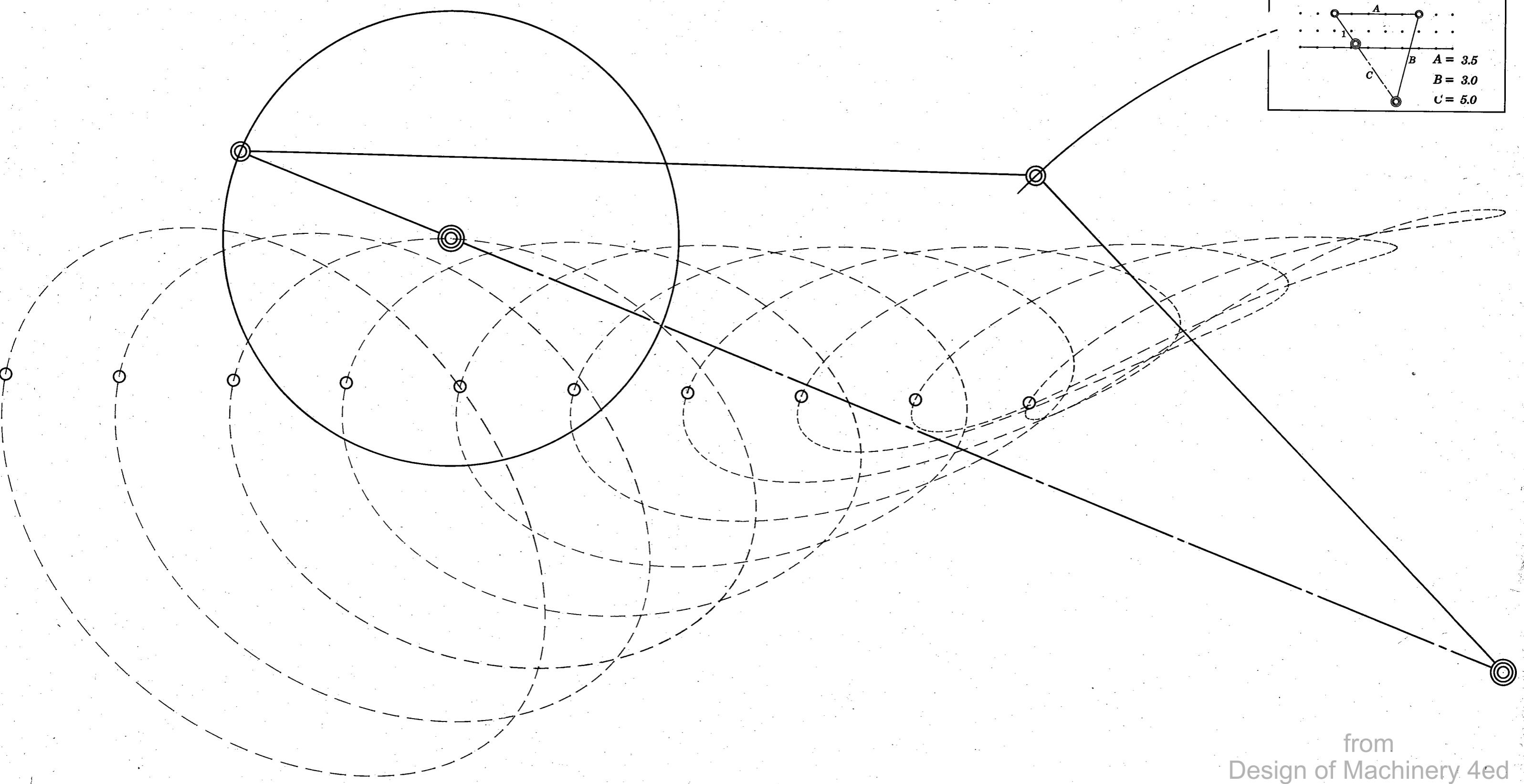
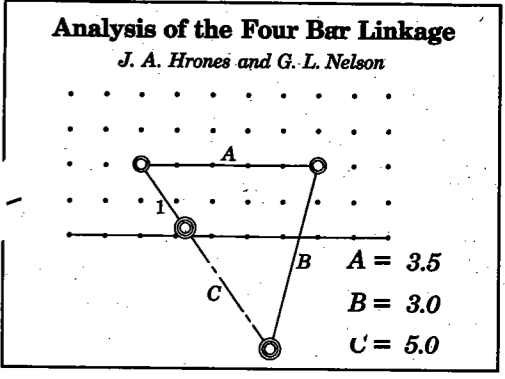

from  
Design of Machinery 4ed  
by Robert L. Norton  
McGraw-Hill  
Copyright 2008

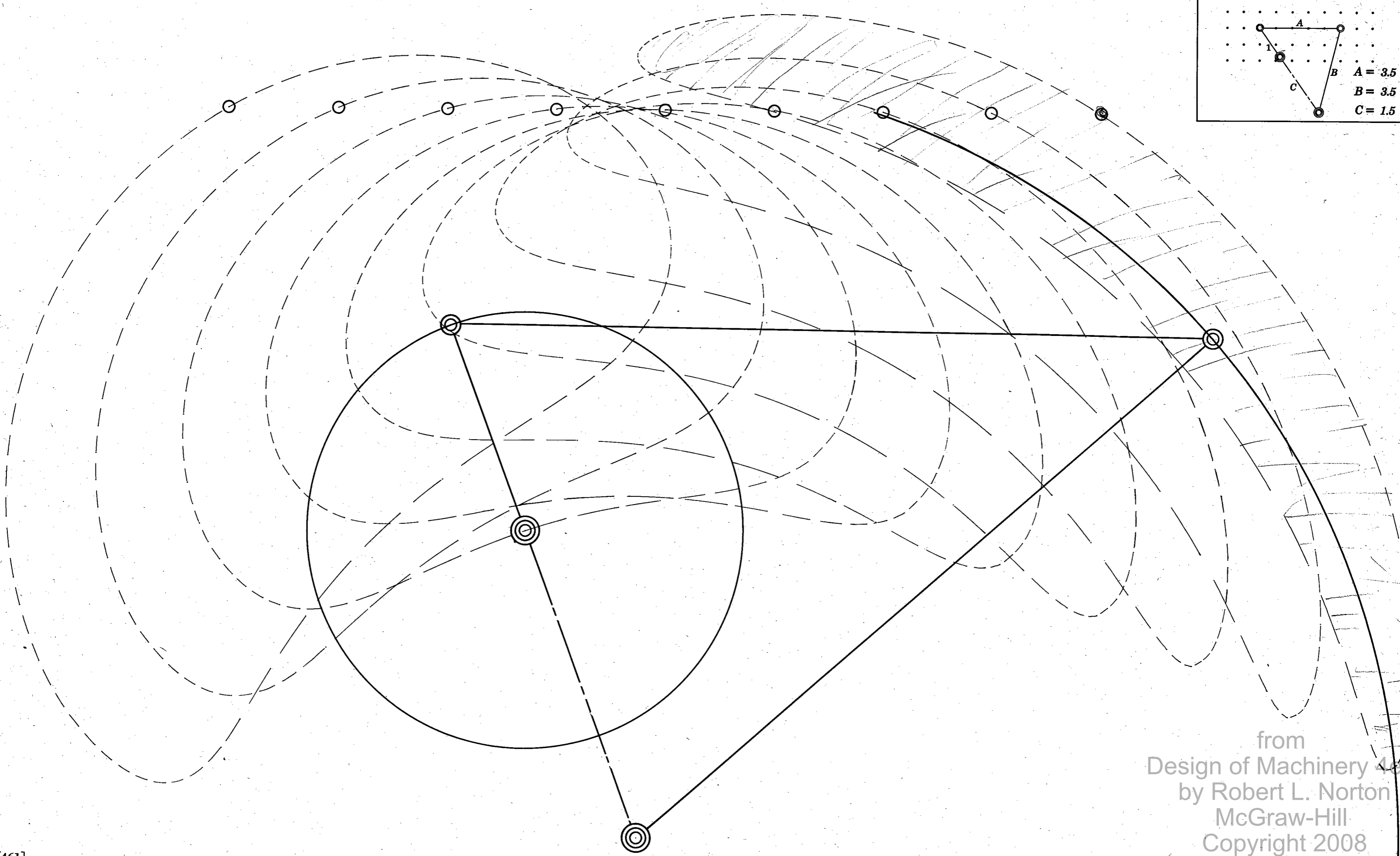
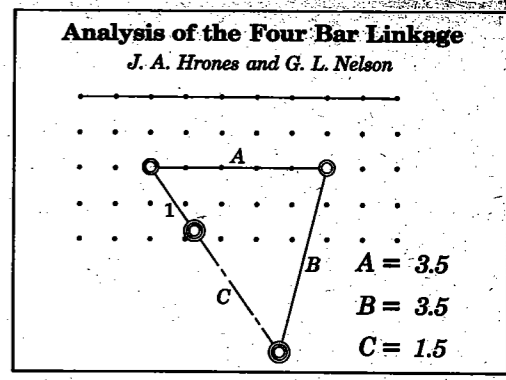

from  
 Design of Machinery 4ed  
 by Robert L. Norton  
 McGraw-Hill  
 Copyright 2008

**Analysis of the Four Bar Linkage**  
*J. A. Hrones and G. L. Nelson*

.....

$A = 3.5$   
 $B = 3.5$   
 $C = 1.5$

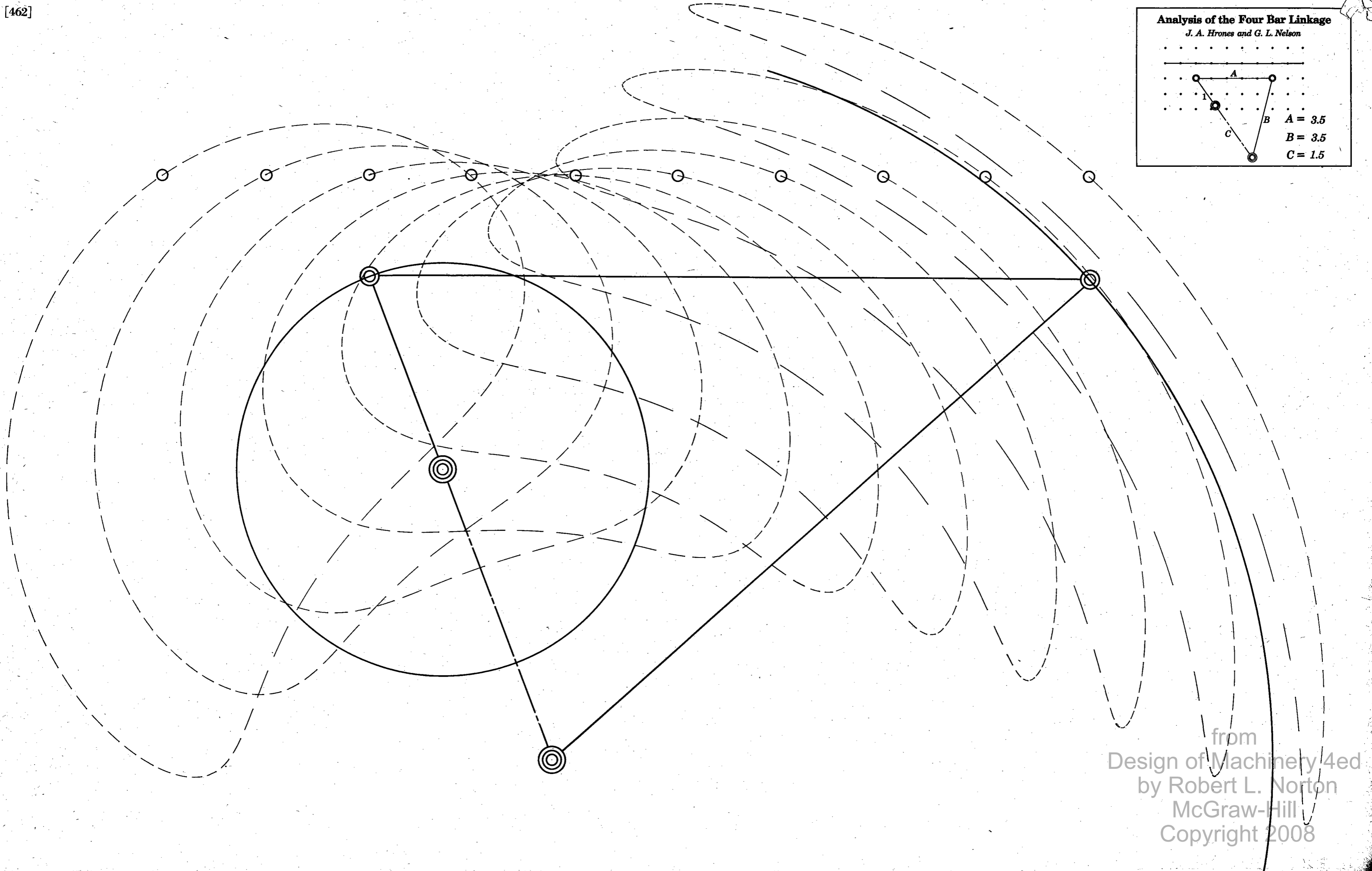

from  
Design of Machinery 4ed  
by Robert L. Norton  
McGraw-Hill  
Copyright 2008

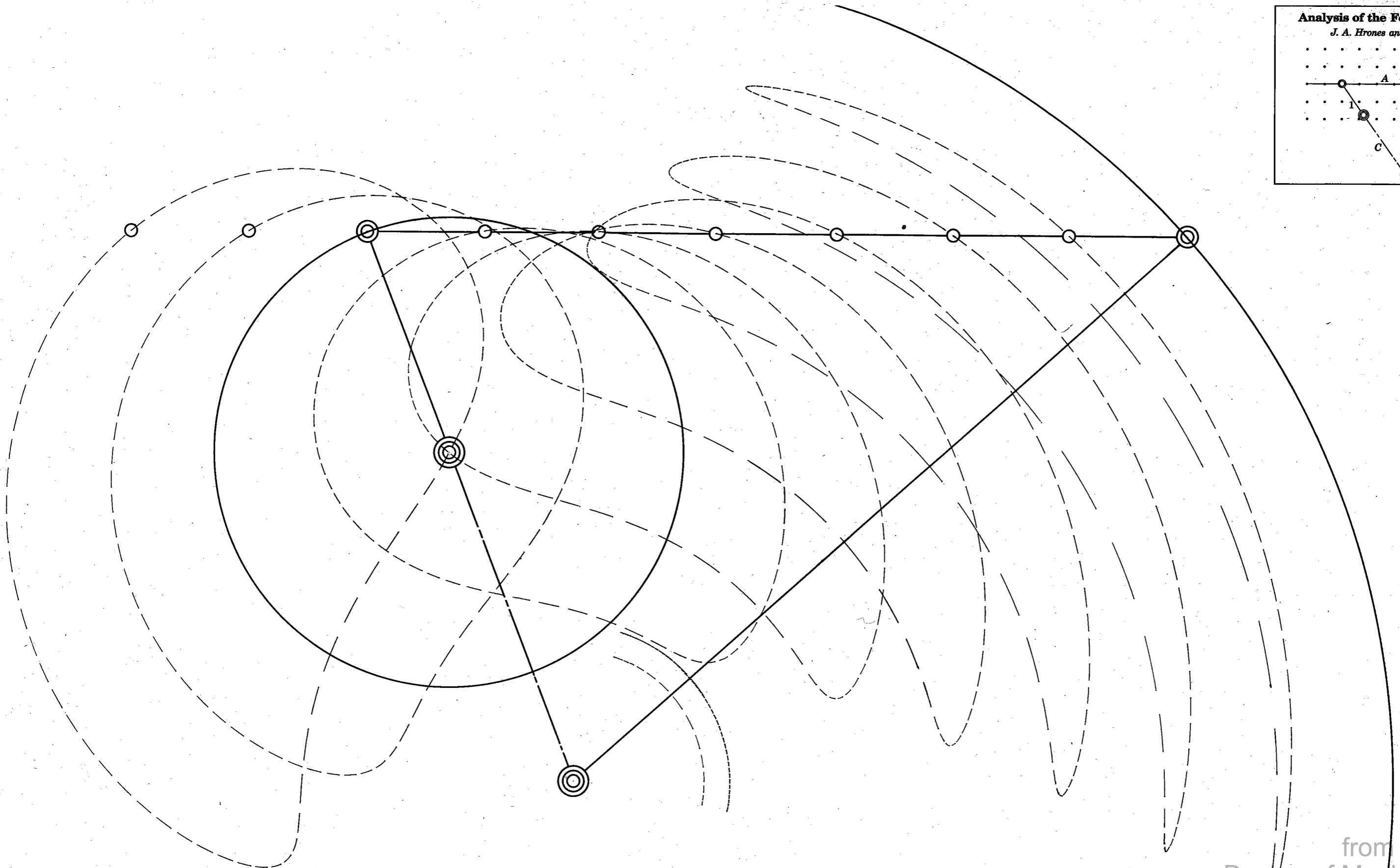
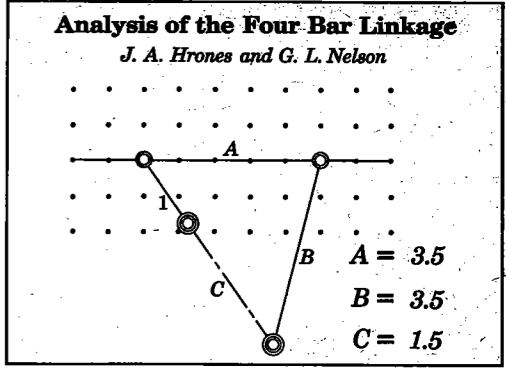

from  
 Design of Machinery 4ed  
 by Robert L. Norton  
 McGraw-Hill  
 Copyright 2008

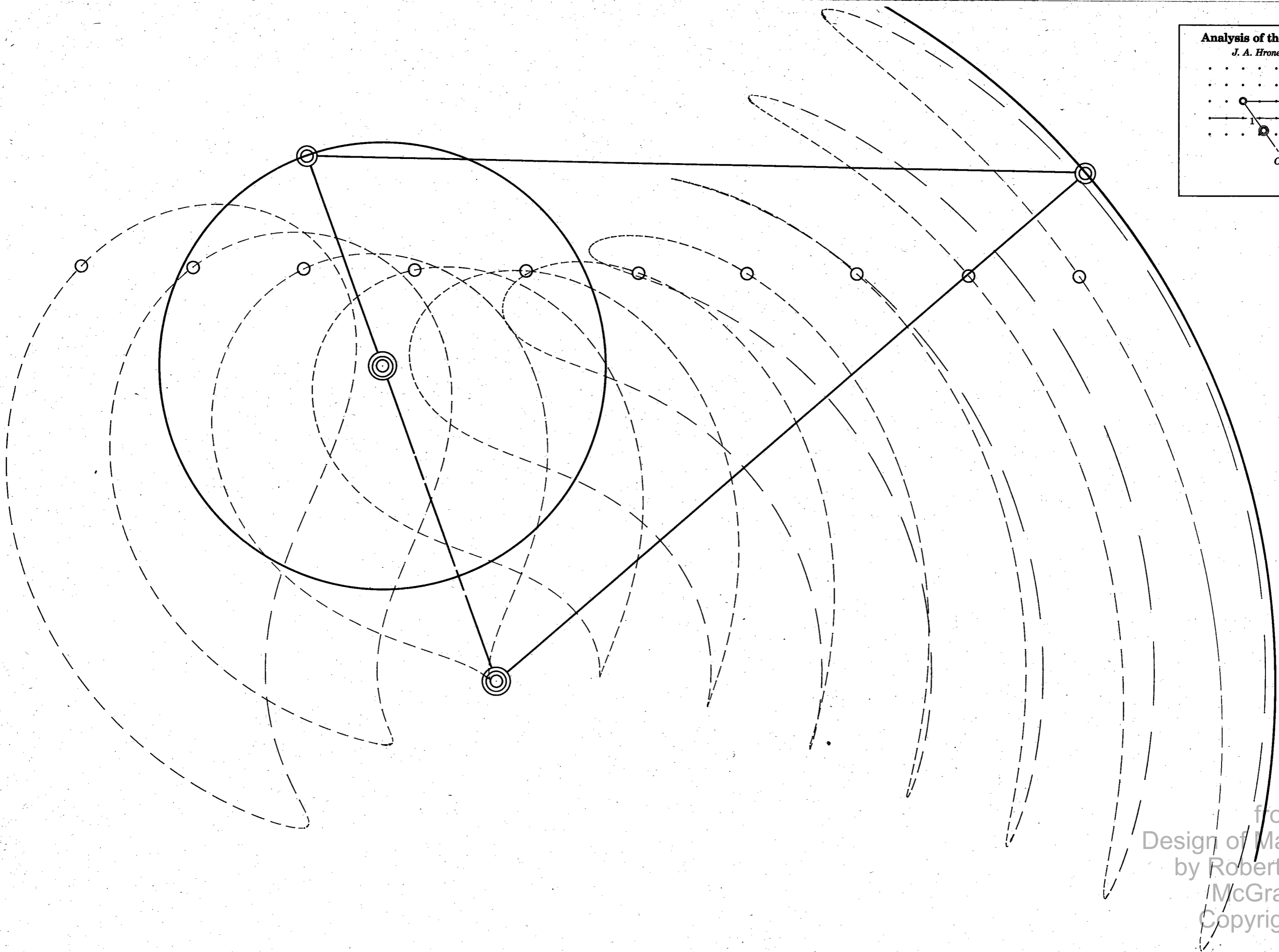
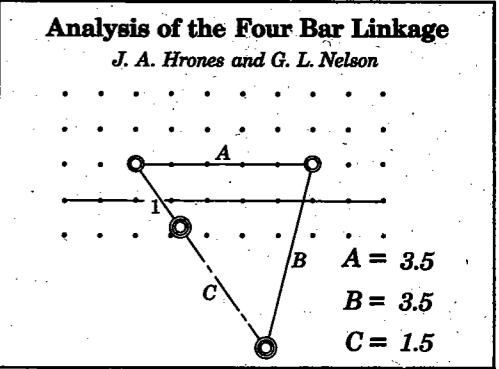

from  
Design of Machinery 4ed  
by Robert L. Norton  
McGraw-Hill  
Copyright 2008

**Analysis of the Four Bar Linkage**  
*J. A. Hrones and G. L. Nelson*

$A = 3.5$   
 $B = 3.5$   
 $C = 1.5$

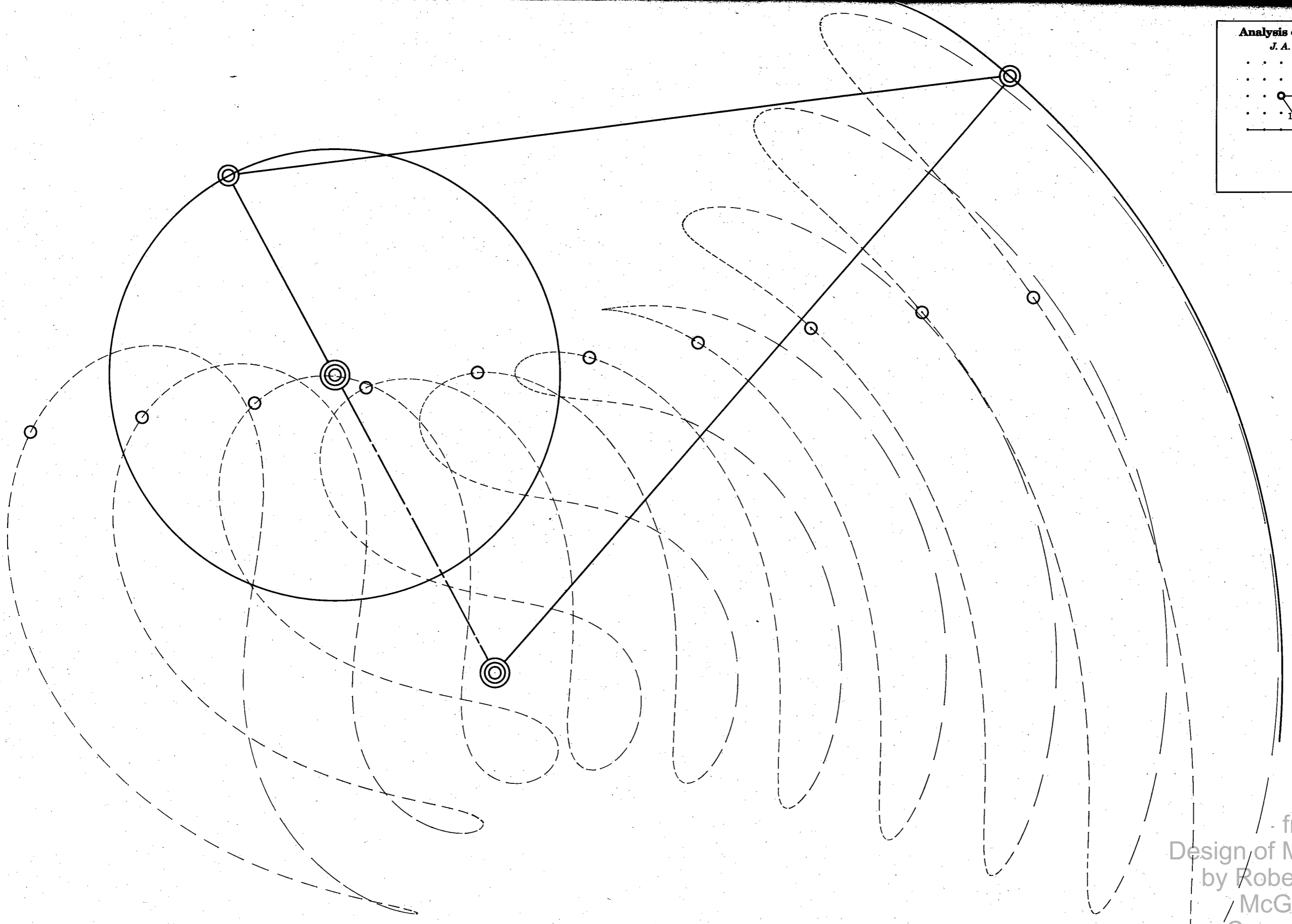

from  
 Design of Machinery 4ed  
 by Robert L. Norton  
 McGraw-Hill  
 Copyright 2008

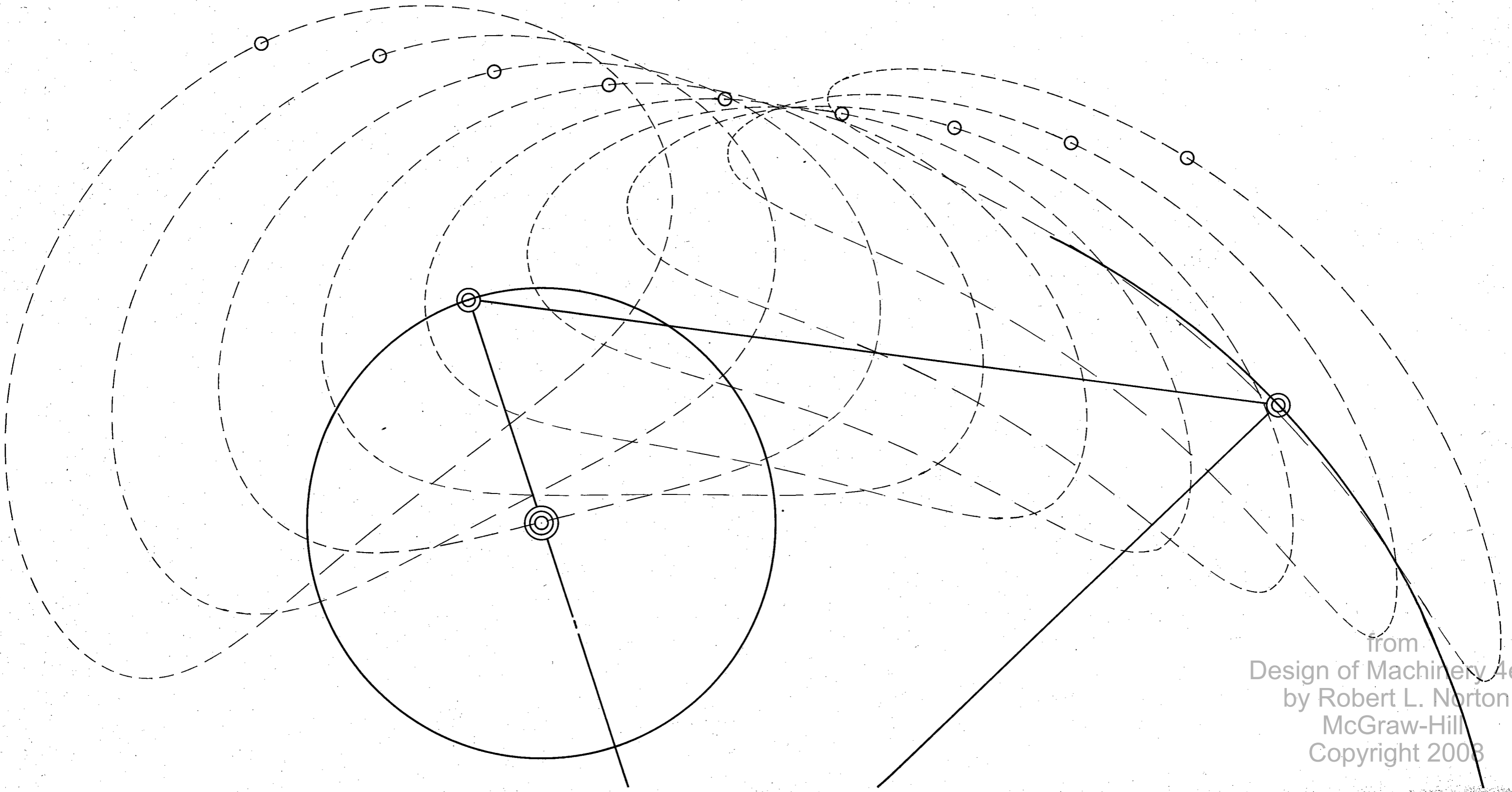
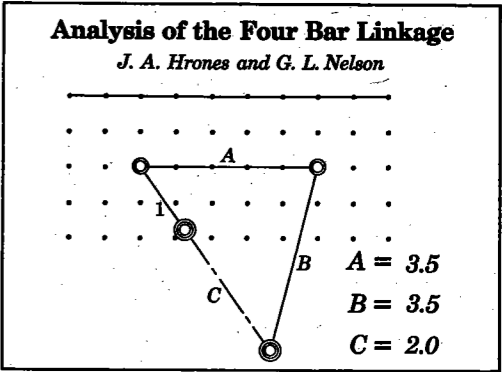

from  
Design of Machinery 4ed  
by Robert L. Norton  
McGraw-Hill  
Copyright 2003

**Analysis of the Four Bar Linkage**  
J. A. Hrones and G. L. Nelson

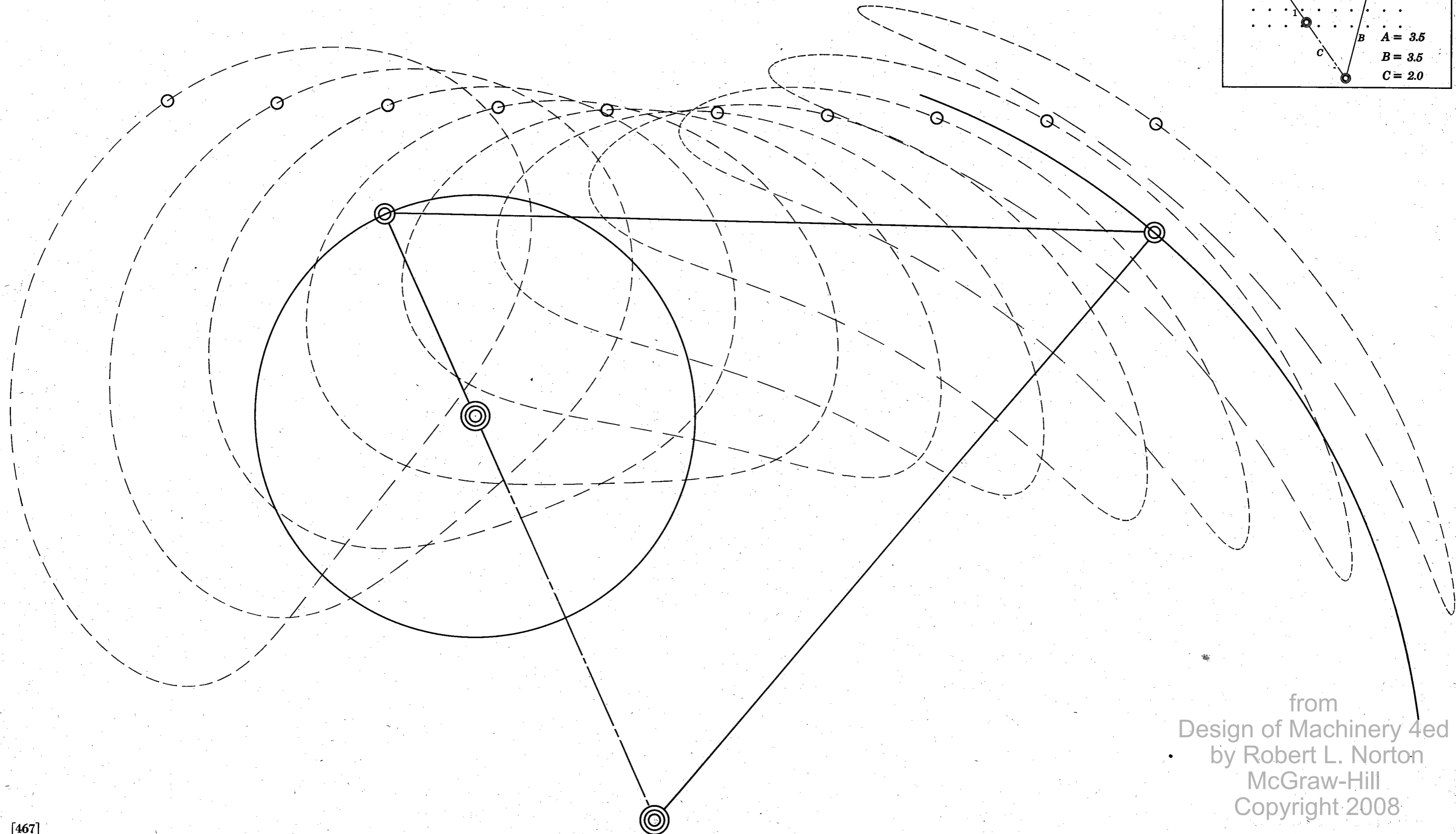
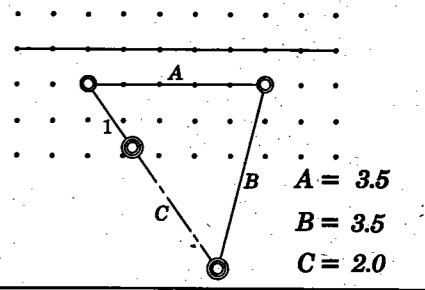

from  
Design of Machinery 4ed  
by Robert L. Norton  
McGraw-Hill  
Copyright 2008



**Analysis of the Four Bar Linkage**  
*J. A. Hrones and G. L. Nelson*

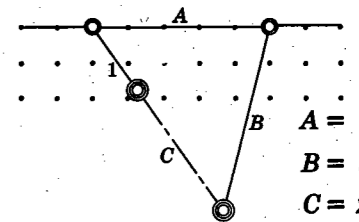

$A = 3.5$   
 $B = 3.5$   
 $C = 2.0$

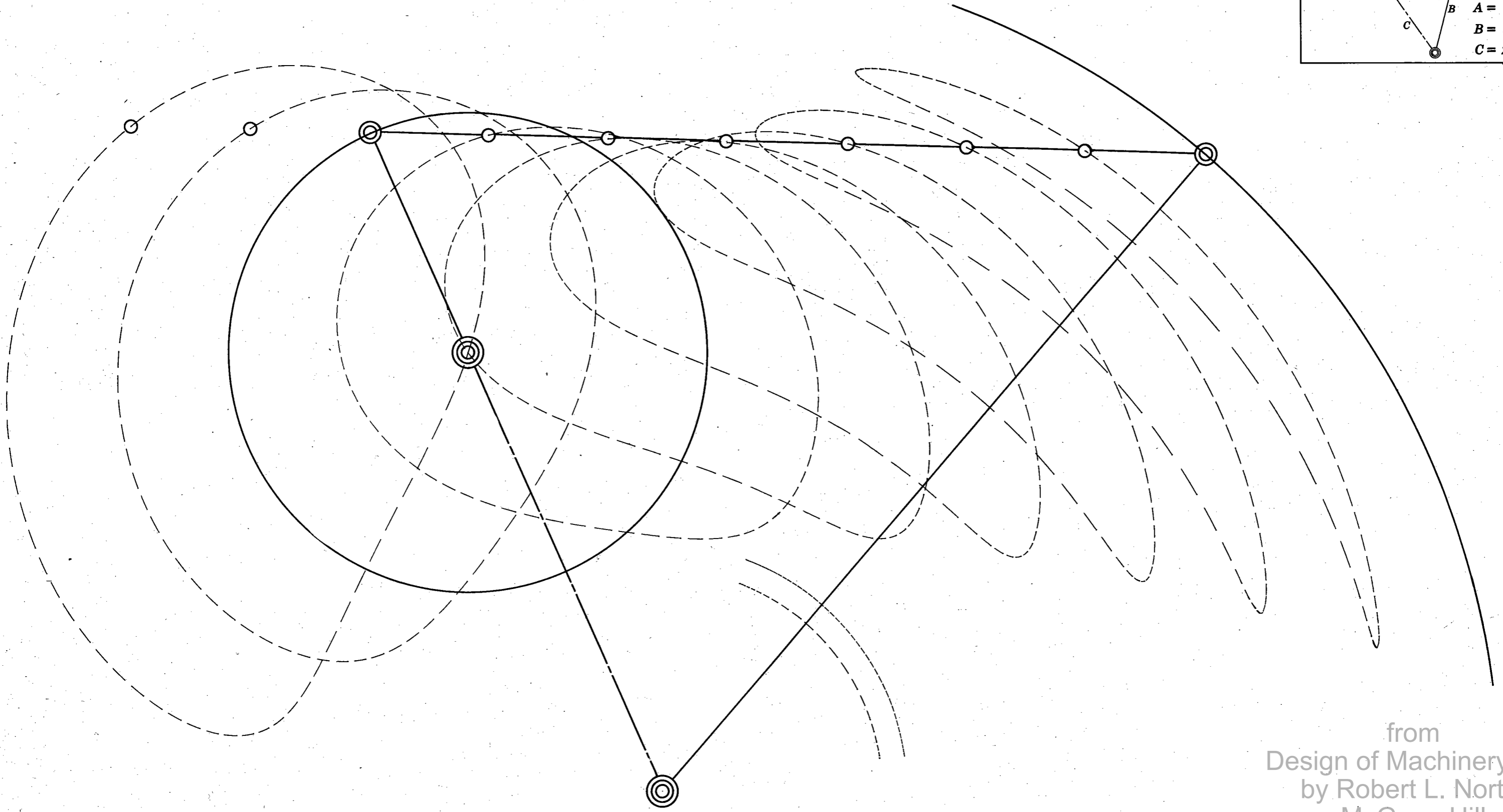

from  
Design of Machinery 4ed  
by Robert L. Norton  
McGraw-Hill  
Copyright 2008

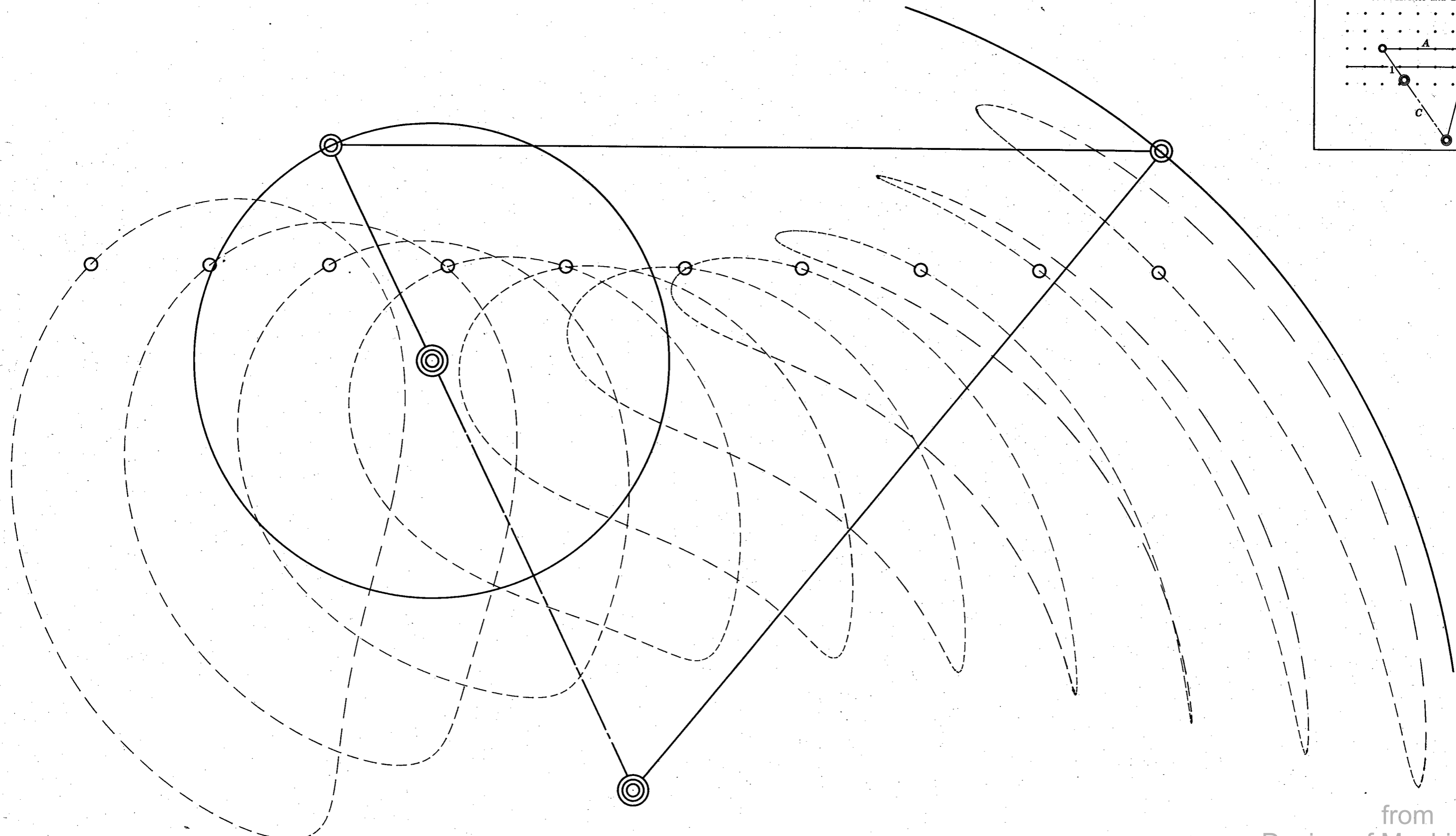
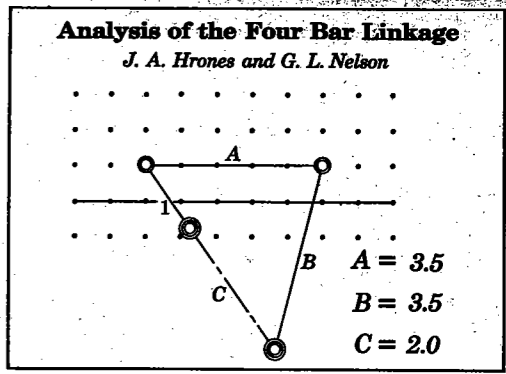

from  
 Design of Machinery 4ed  
 by Robert L. Norton  
 McGraw-Hill  
 Copyright 2008

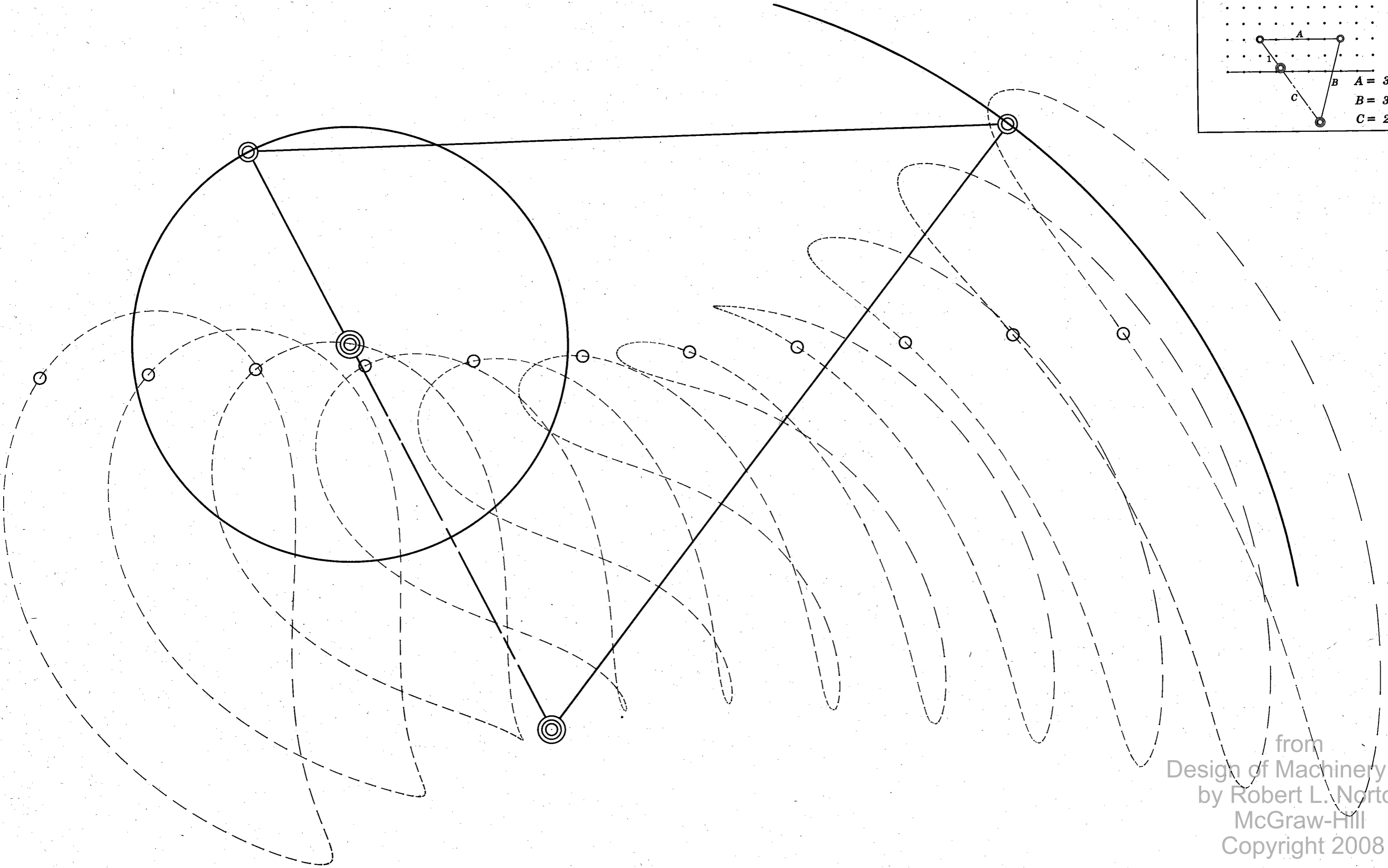
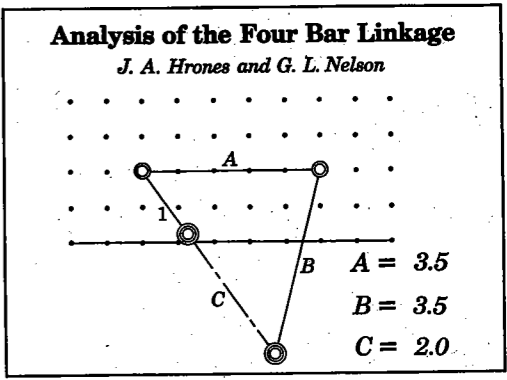

from  
Design of Machinery 4ed  
by Robert L. Norton  
McGraw-Hill  
Copyright 2008

**Analysis of the Four Bar Linkage**  
*J. A. Hrones and G. L. Nelson*

$A = 3.5$   
 $B = 3.5$   
 $C = 2.5$

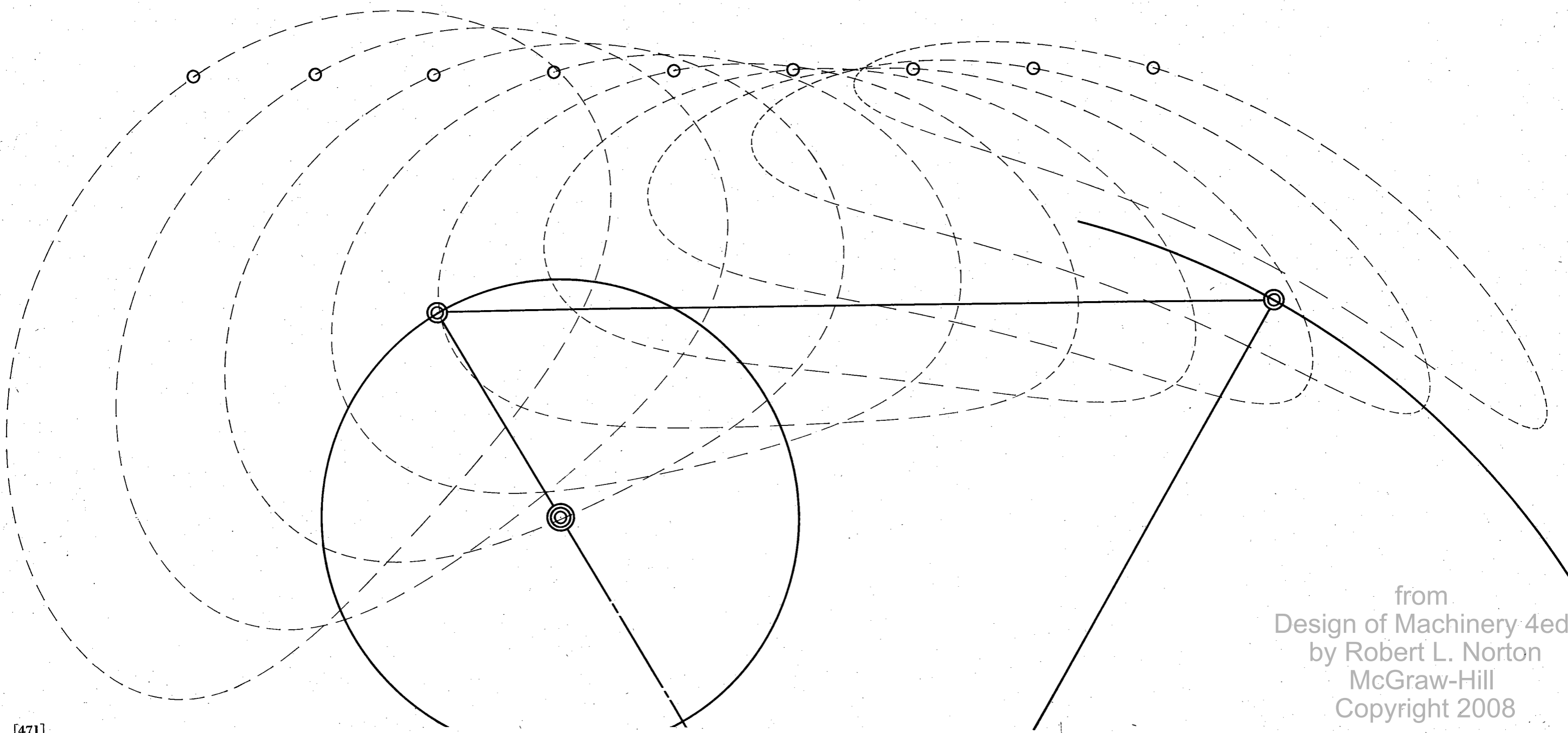

from  
 Design of Machinery 4ed  
 by Robert L. Norton  
 McGraw-Hill  
 Copyright 2008

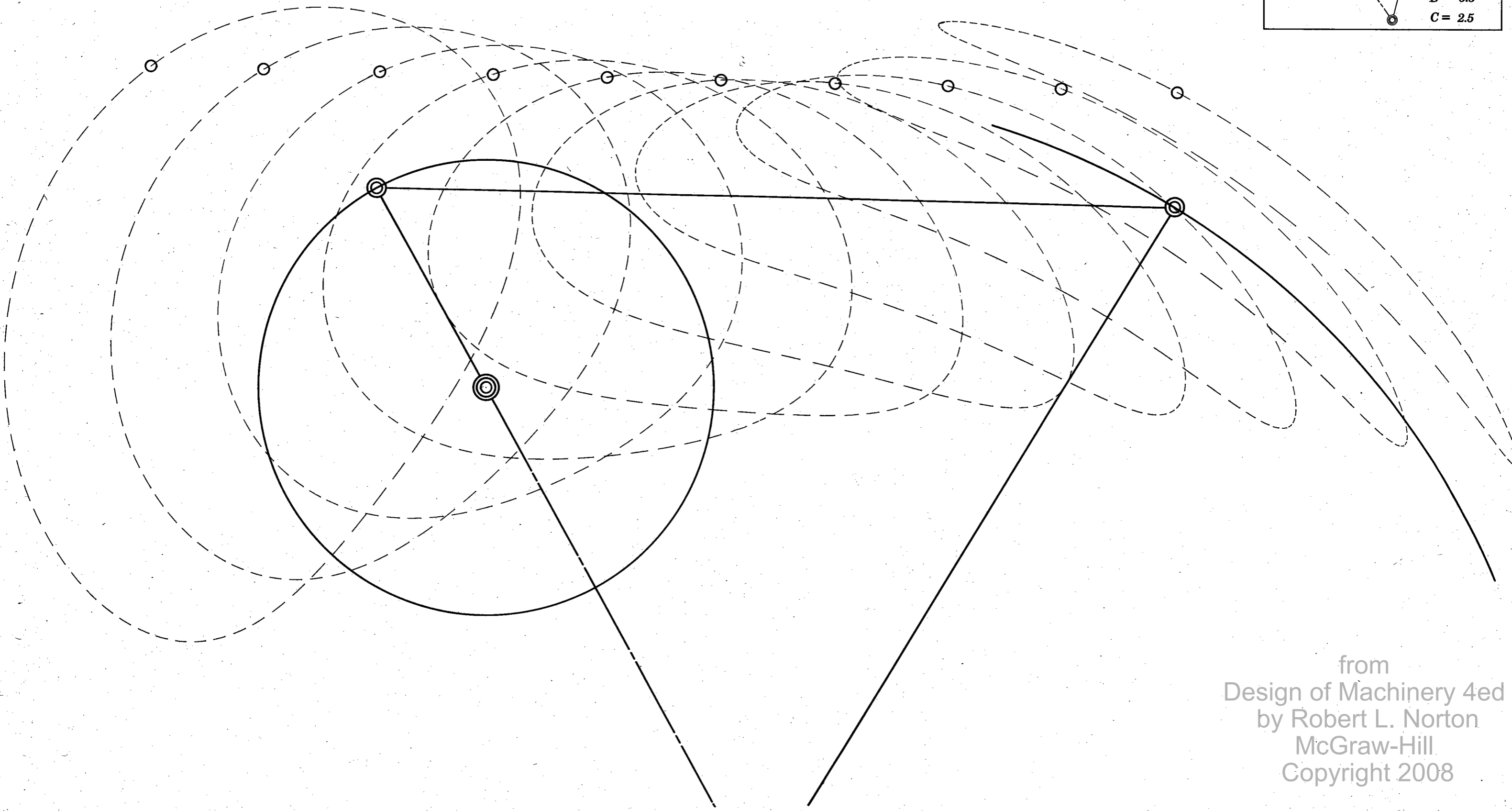
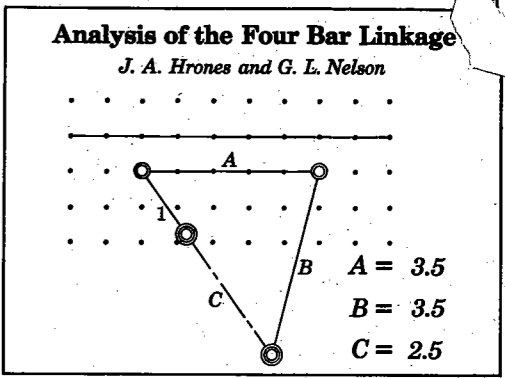

from  
Design of Machinery 4ed  
by Robert L. Norton  
McGraw-Hill  
Copyright 2008

**Analysis of the Four Bar Linkage**  
*J. A. Hrones and G. L. Nelson*

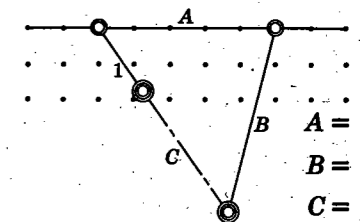

$A = 3.5$   
 $B = 3.5$   
 $C = 2.5$

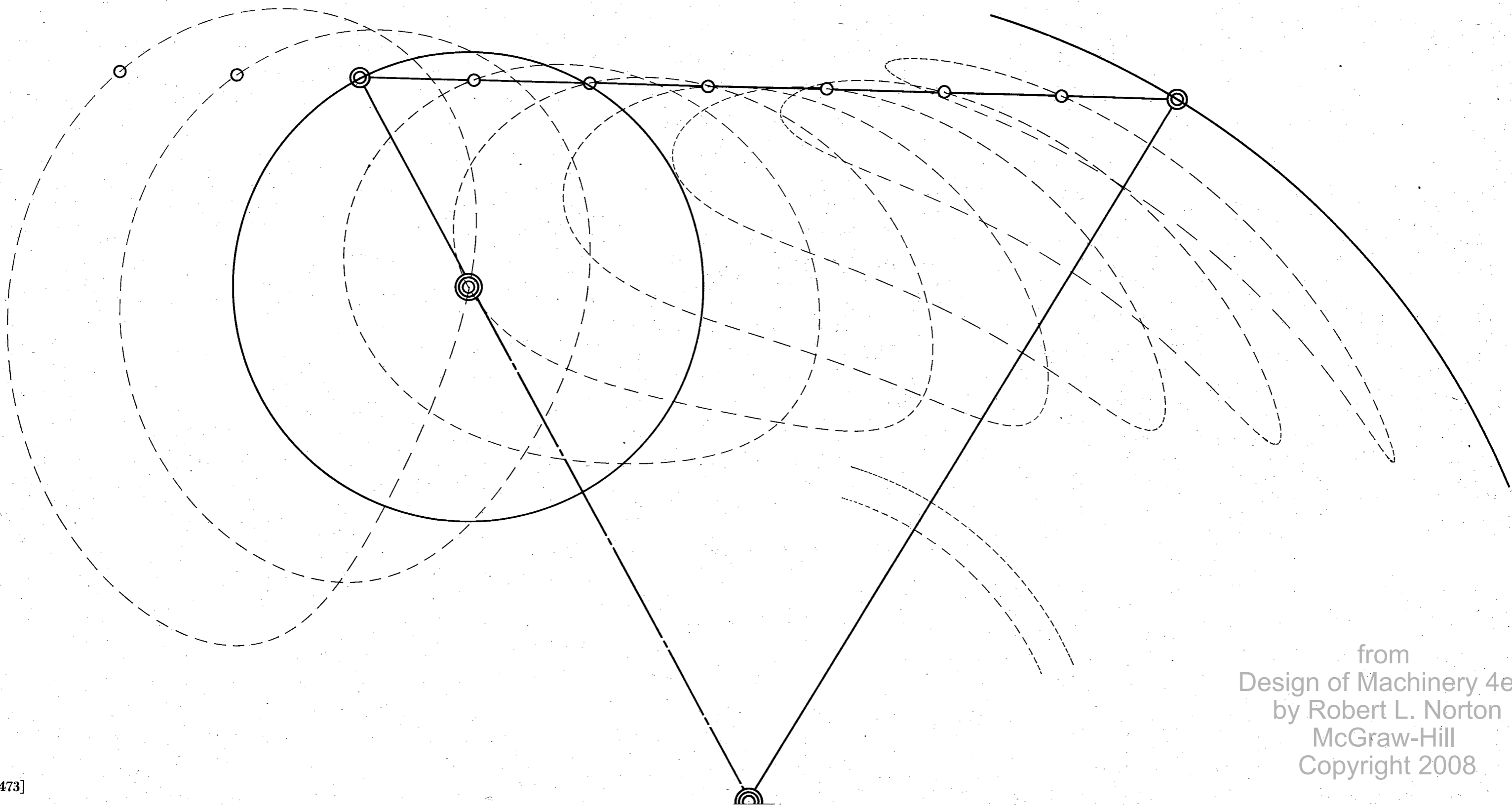

from  
 Design of Machinery 4ed  
 by Robert L. Norton  
 McGraw-Hill  
 Copyright 2008

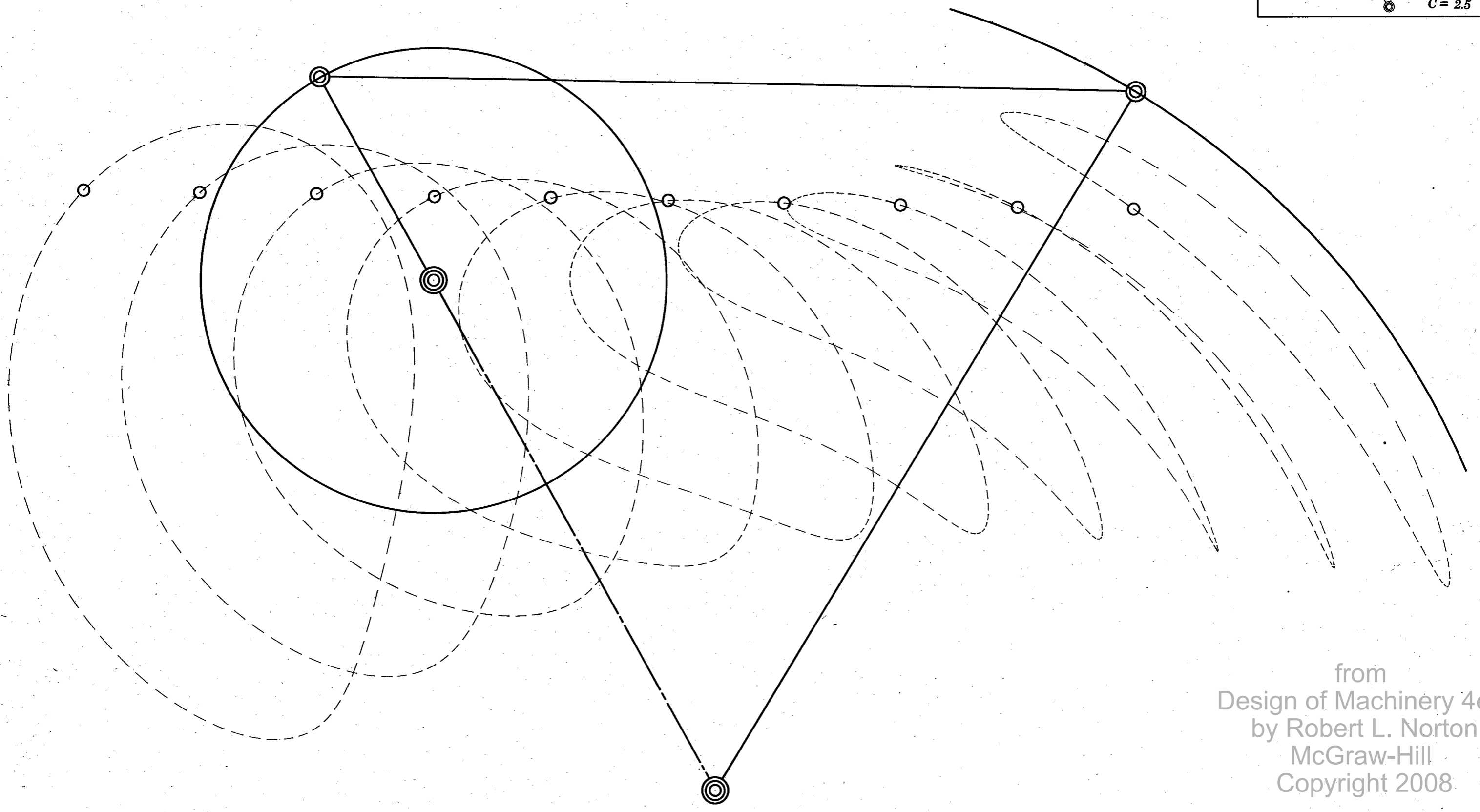
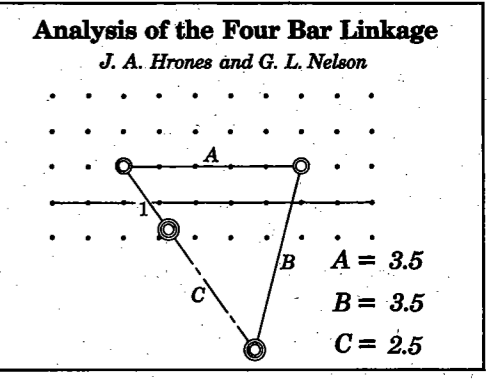

from  
Design of Machinery 4ed  
by Robert L. Norton  
McGraw-Hill  
Copyright 2008

**Analysis of the Four Bar Linkage**  
*J. A. Hrones and G. L. Nelson*

$A = 3.5$   
 $B = 3.5$   
 $C = 2.5$

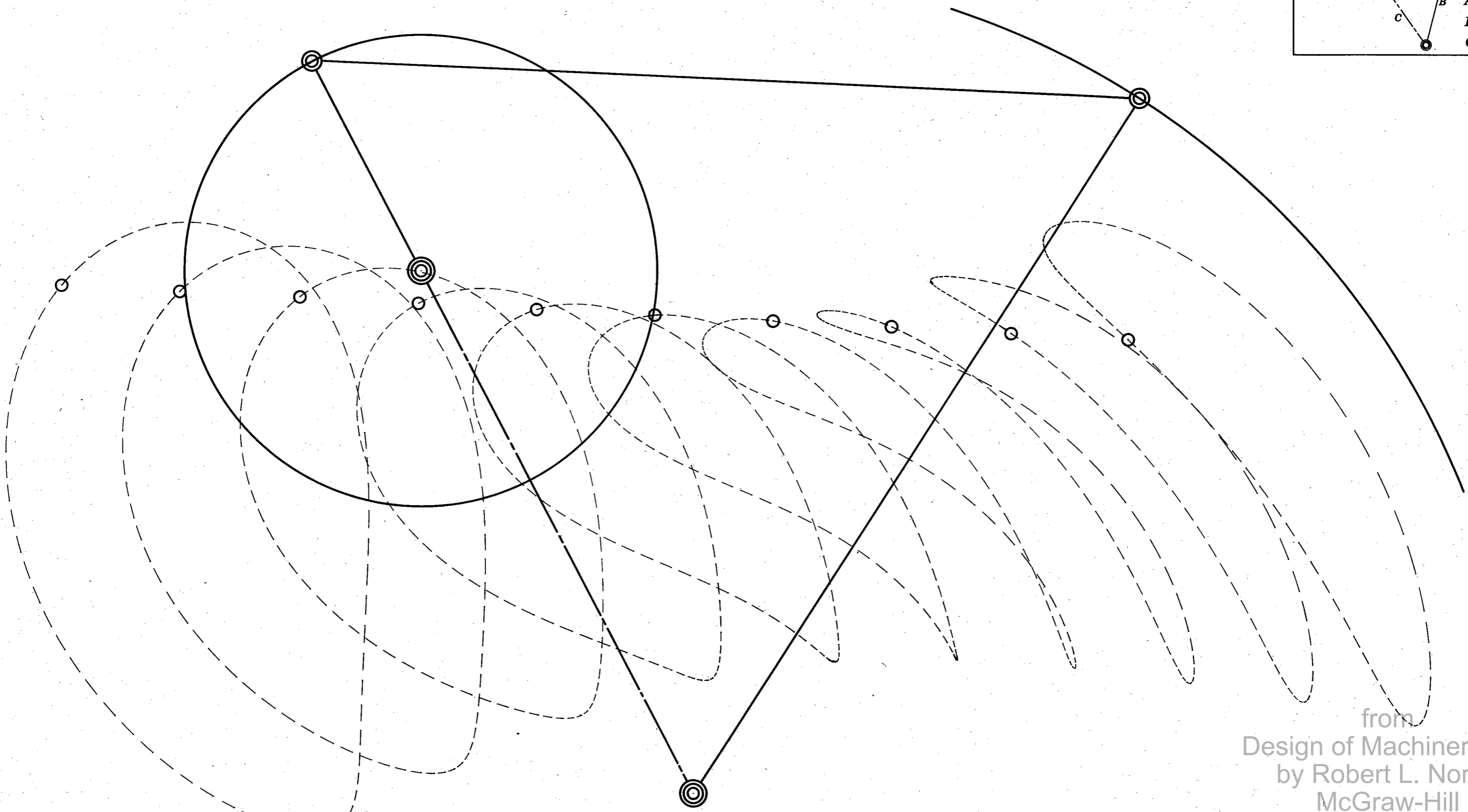

from  
 Design of Machinery 4ed  
 by Robert L. Norton  
 McGraw-Hill  
 Copyright 2008



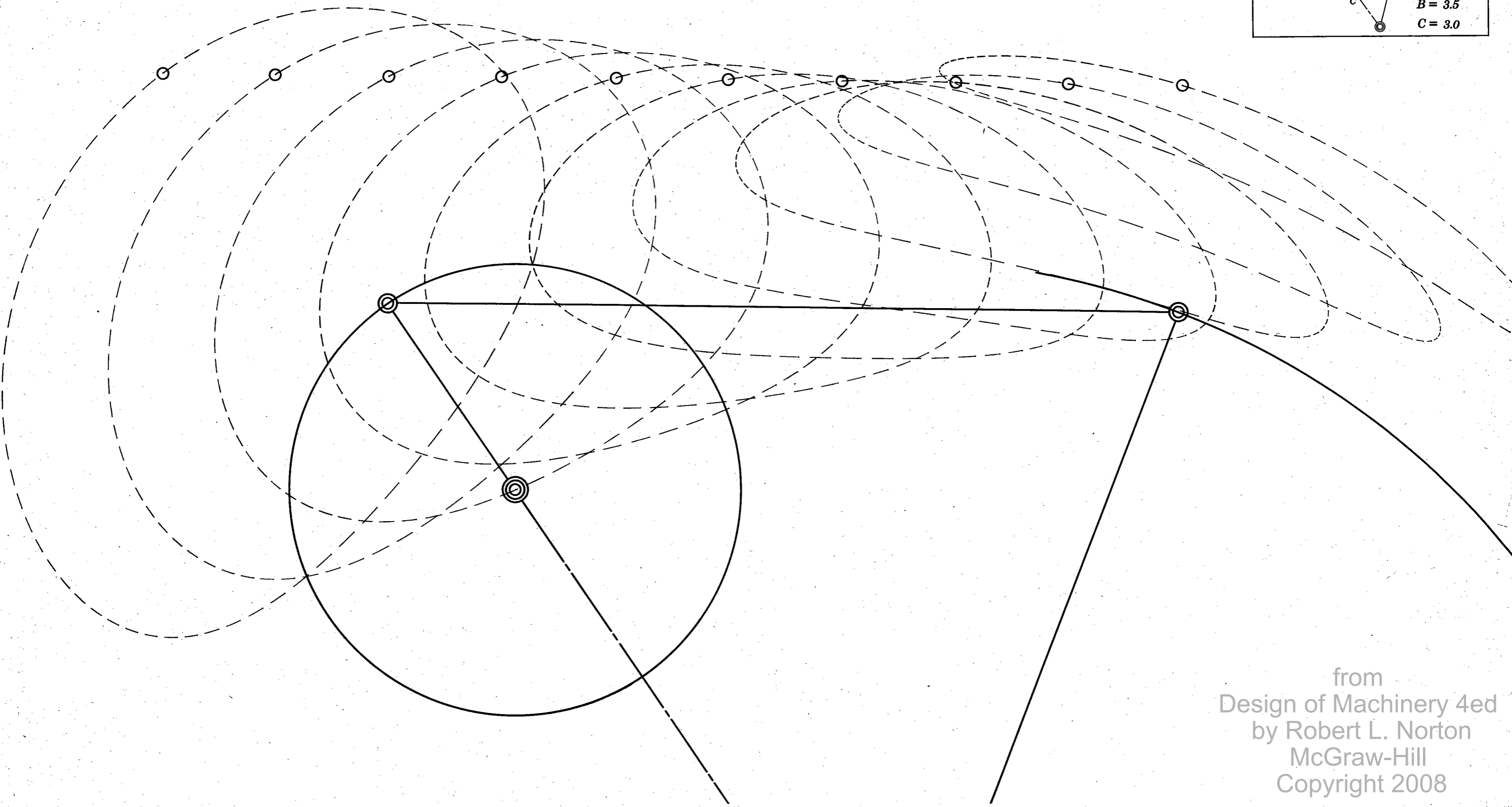
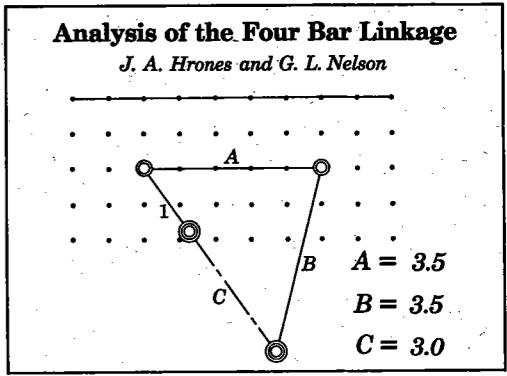

from  
Design of Machinery 4ed  
by Robert L. Norton  
McGraw-Hill  
Copyright 2008

**Analysis of the Four Bar Linkage**

*J. A. Hrones and G. L. Nelson*

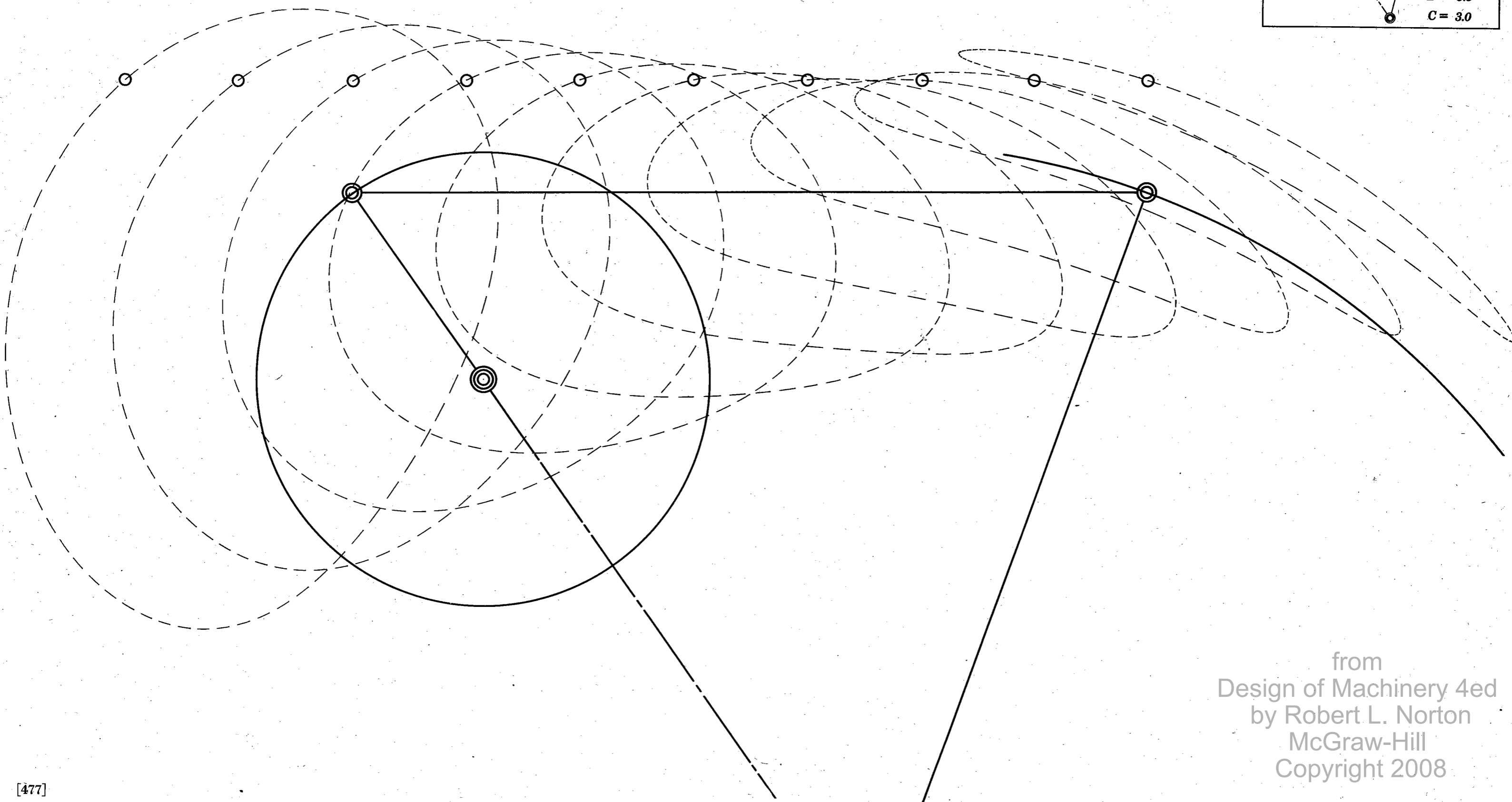
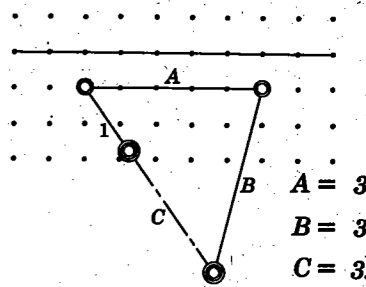

from  
Design of Machinery 4ed  
by Robert L. Norton  
McGraw-Hill  
Copyright 2008

**Analysis of the Four Bar Linkage**  
*J. A. Hrones and G. L. Nelson*

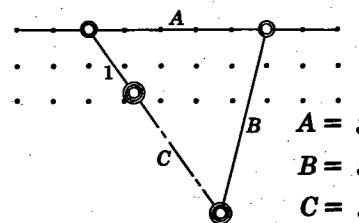

$A = 3.5$   
 $B = 3.5$   
 $C = 3.0$

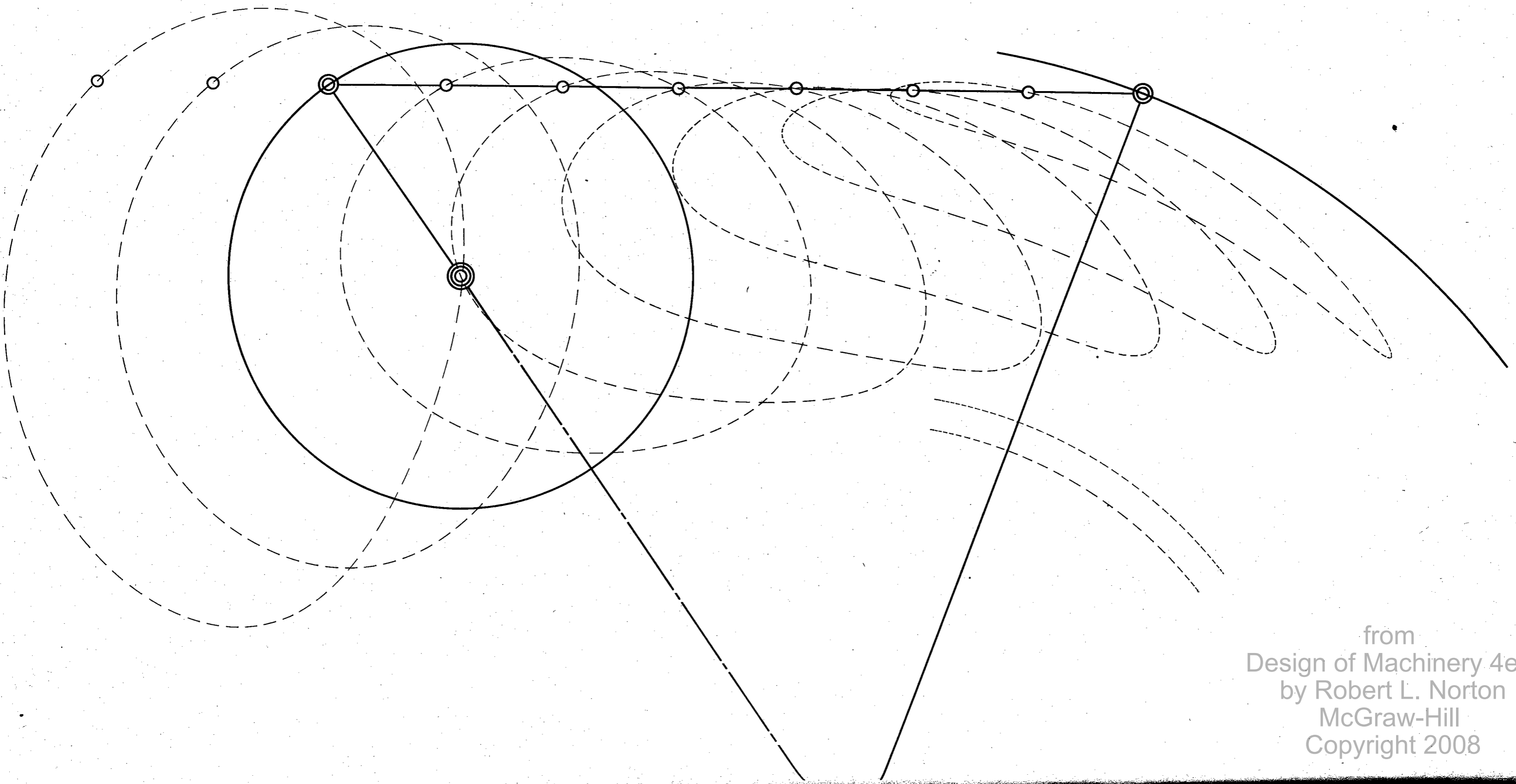

from  
Design of Machinery 4ed  
by Robert L. Norton  
McGraw-Hill  
Copyright 2008

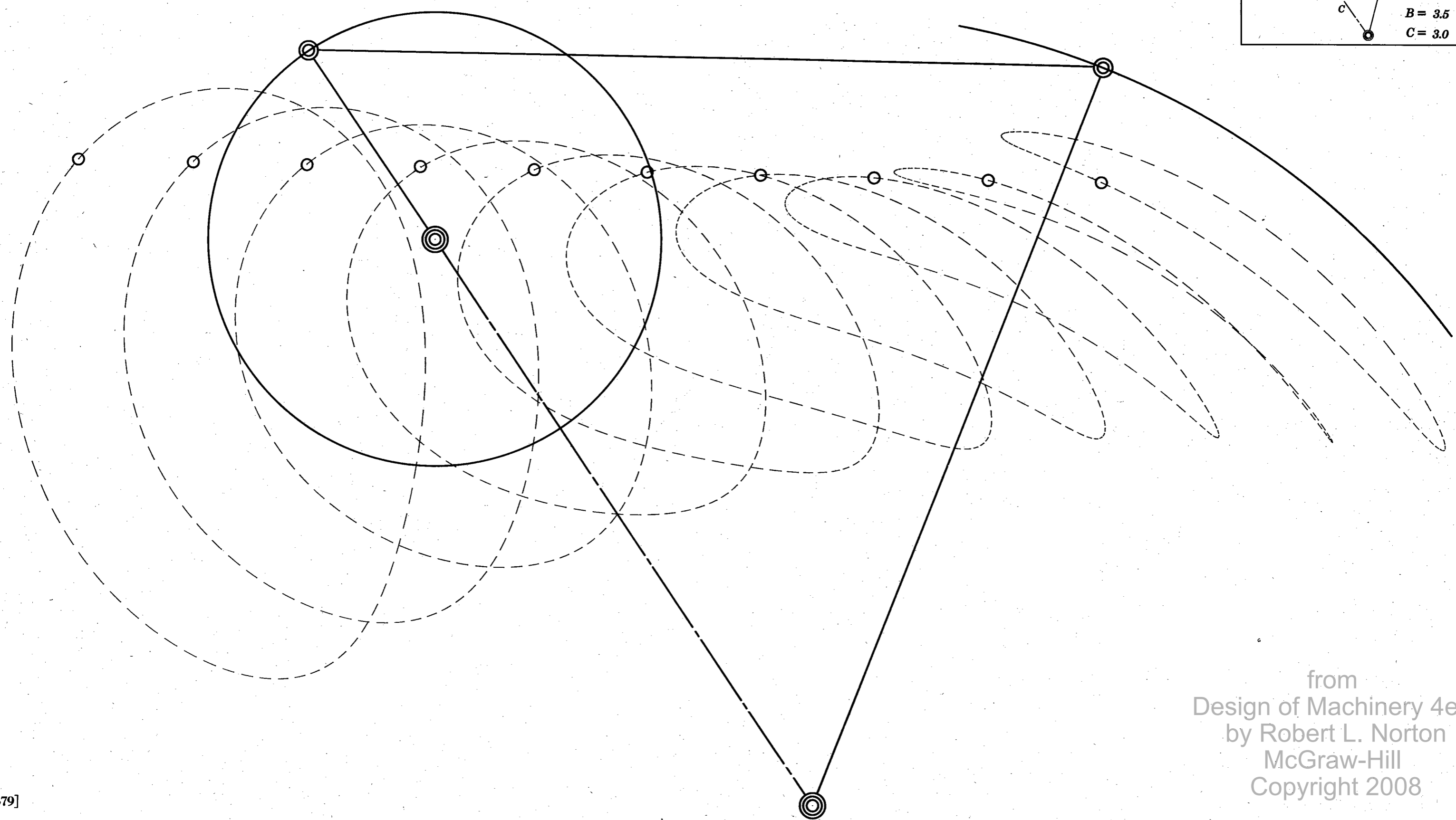
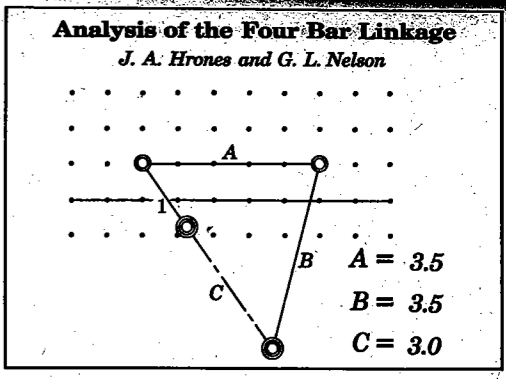

from  
 Design of Machinery 4ed  
 by Robert L. Norton  
 McGraw-Hill  
 Copyright 2008

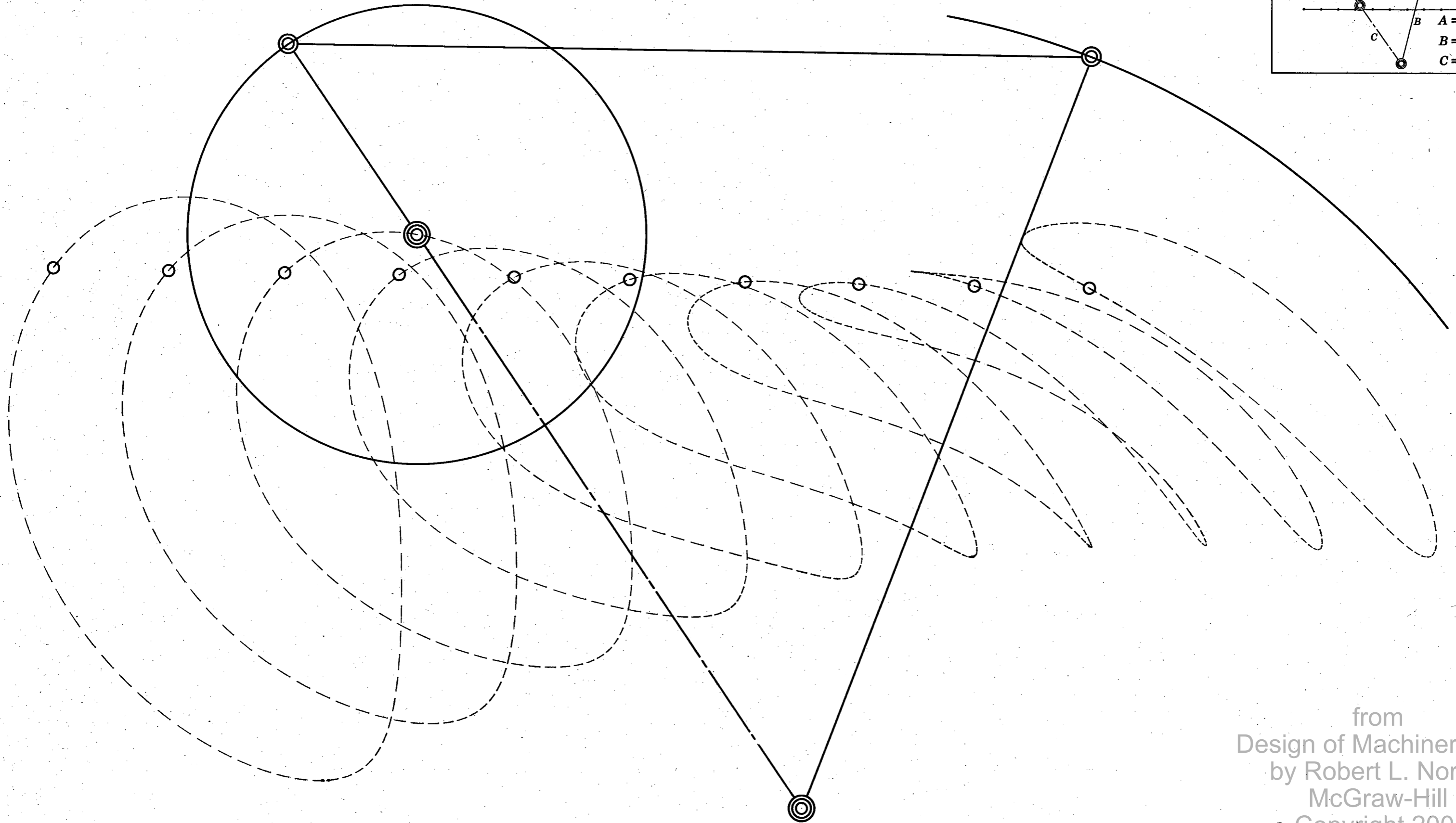
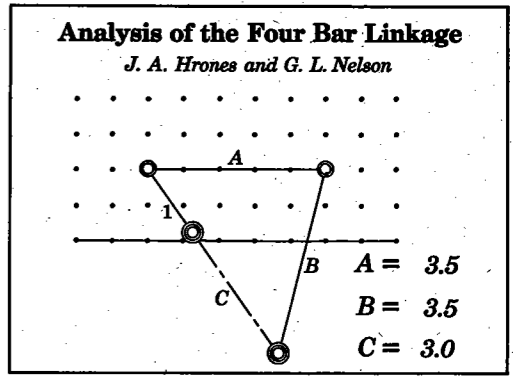

from  
Design of Machinery 4ed  
by Robert L. Norton  
McGraw-Hill  
Copyright 2008

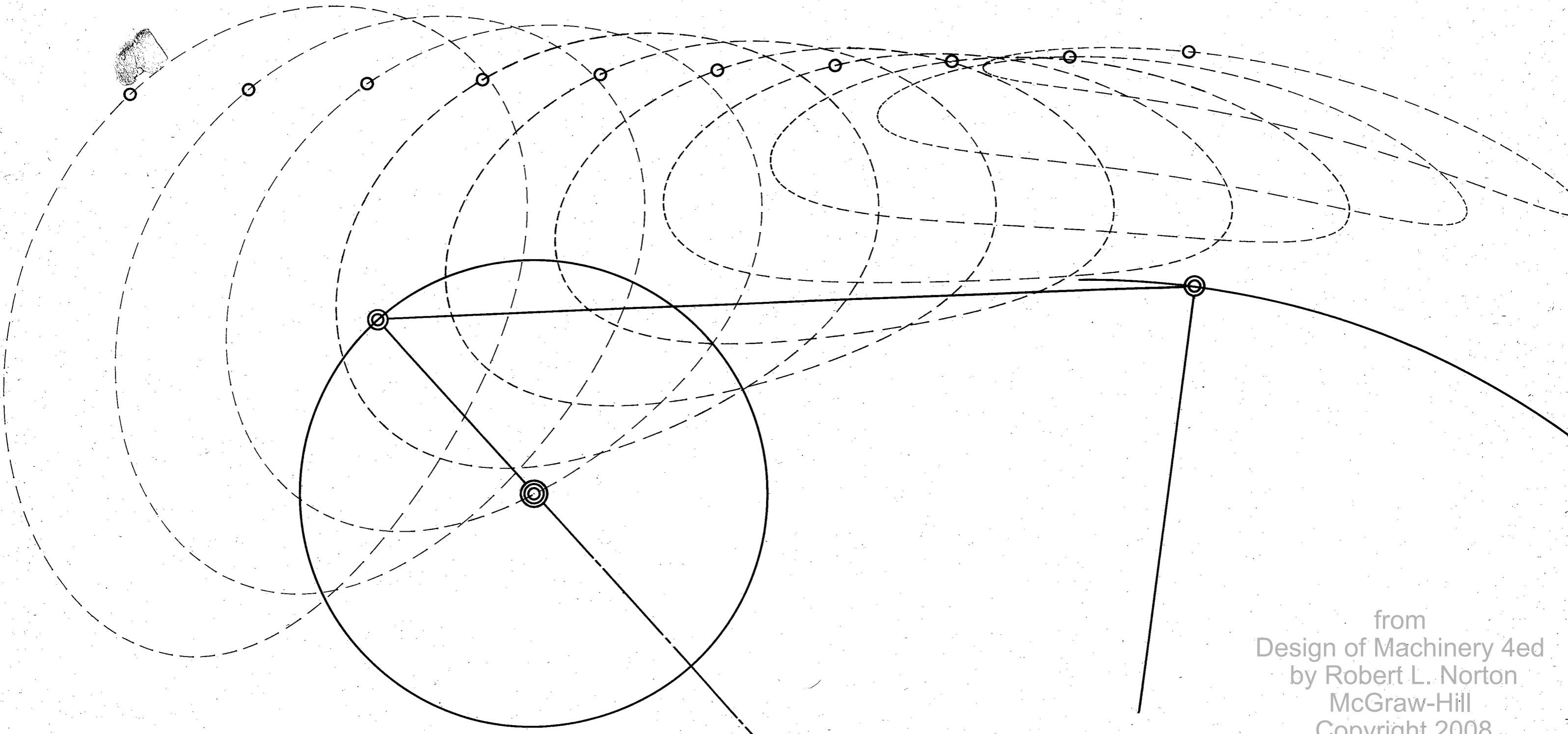
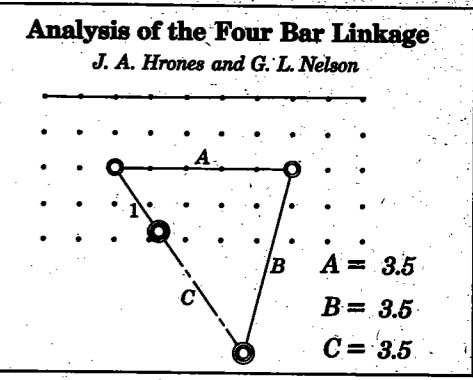

from  
 Design of Machinery 4ed  
 by Robert L. Norton  
 McGraw-Hill  
 Copyright 2008

**Analysis of the Four Bar Linkage**  
*J. A. Hrones and G. L. Nelson*

$A = 3.5$   
 $B = 3.5$   
 $C = 3.5$

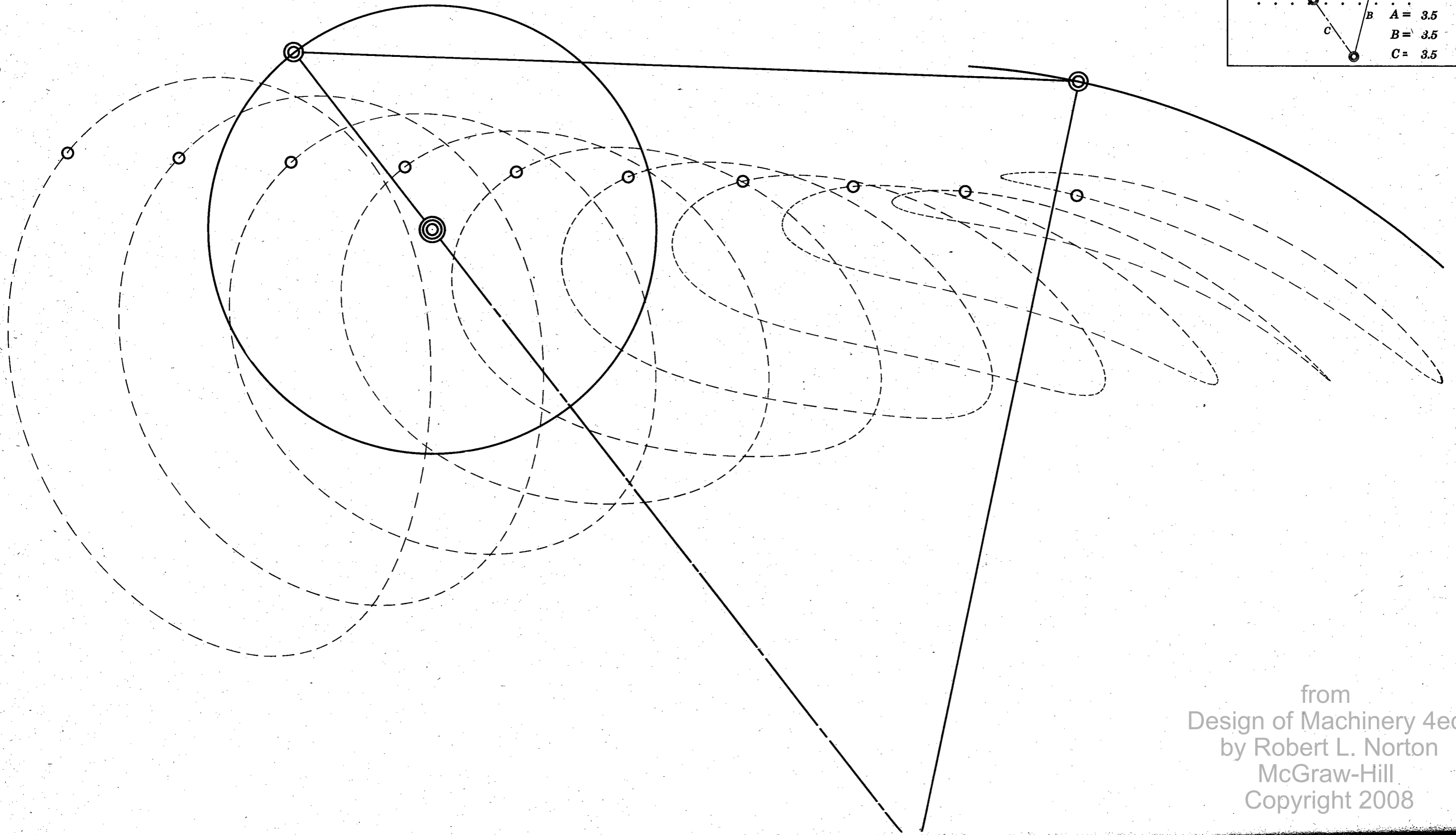

from  
Design of Machinery 4ed  
by Robert L. Norton  
McGraw-Hill  
Copyright 2008

**Analysis of the Four Bar Linkage**  
*J. A. Hrones and G. L. Nelson*

$A = 3.5$   
 $B = 3.5$   
 $C = 3.5$

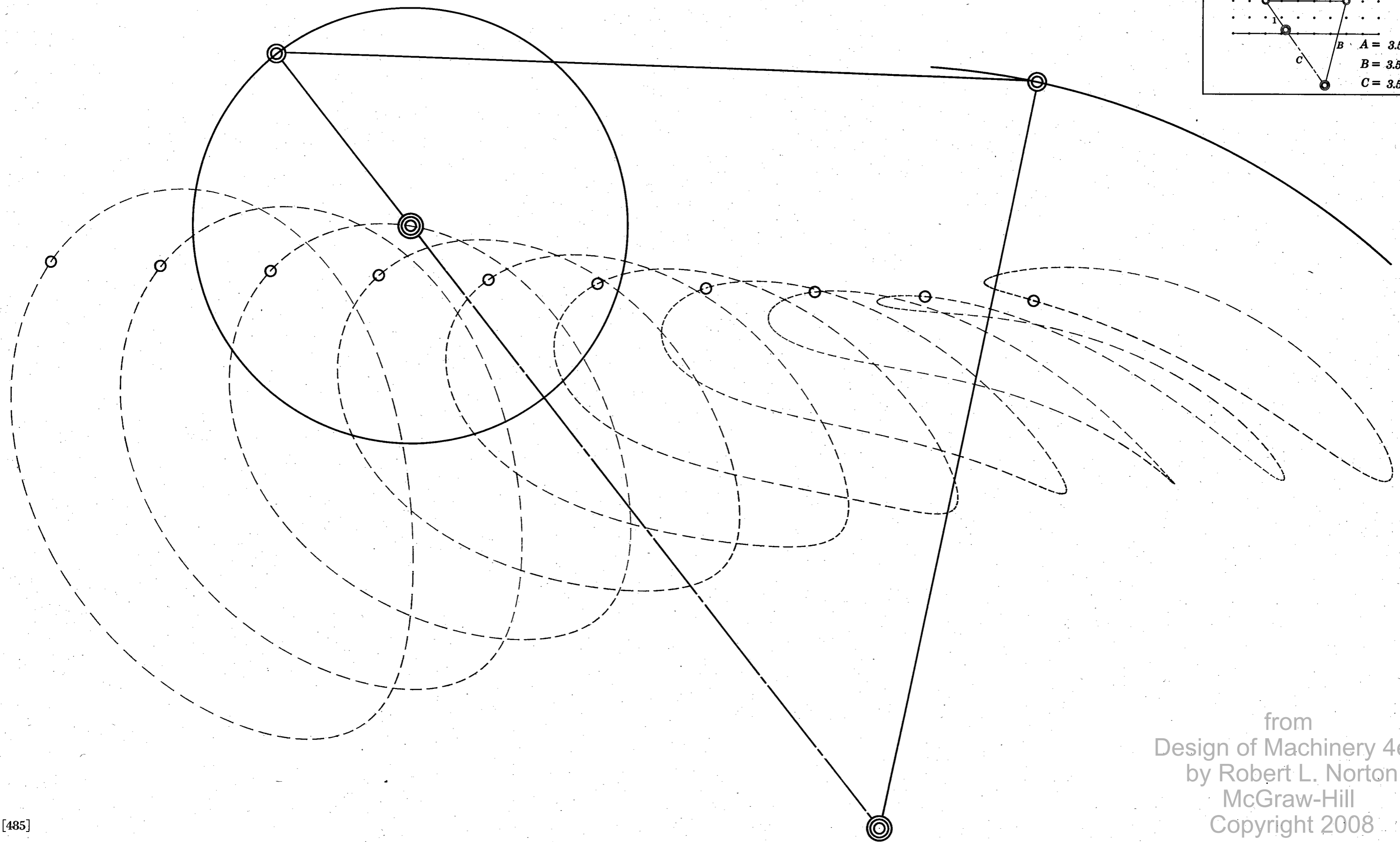

from  
 Design of Machinery 4ed  
 by Robert L. Norton  
 McGraw-Hill  
 Copyright 2008



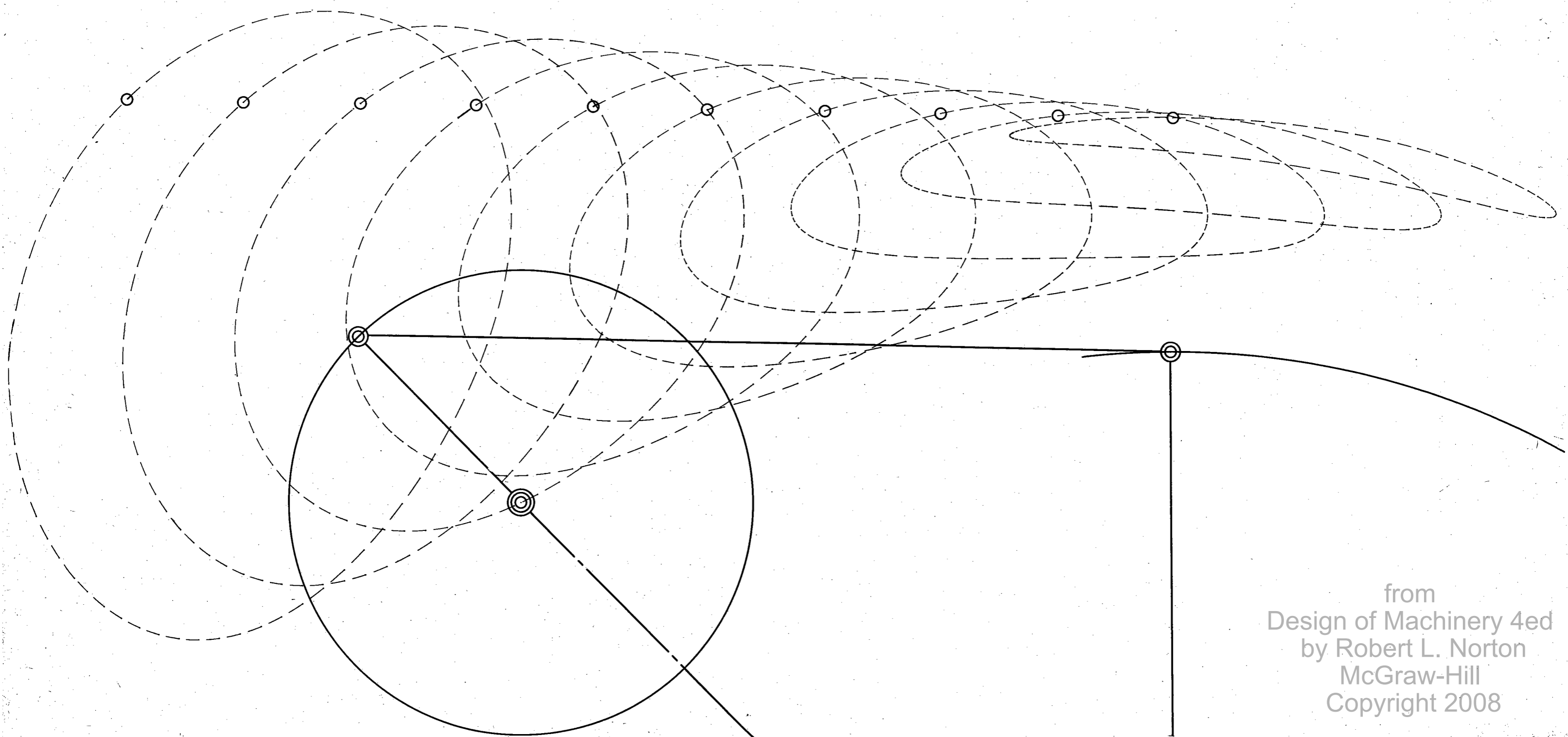
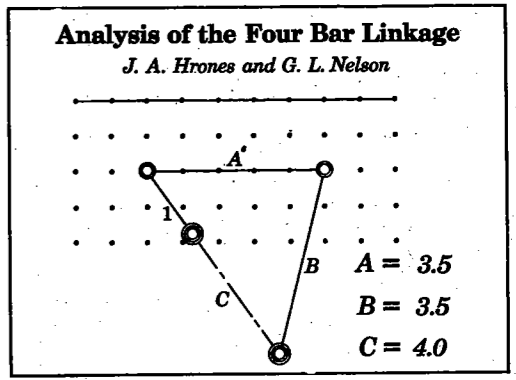

from  
Design of Machinery 4ed  
by Robert L. Norton  
McGraw-Hill  
Copyright 2008

**Analysis of the Four Bar Linkage**  
*J. A. Hrones and G. L. Nelson*

$A = 3.5$   
 $B = 3.5$   
 $C = 4.0$

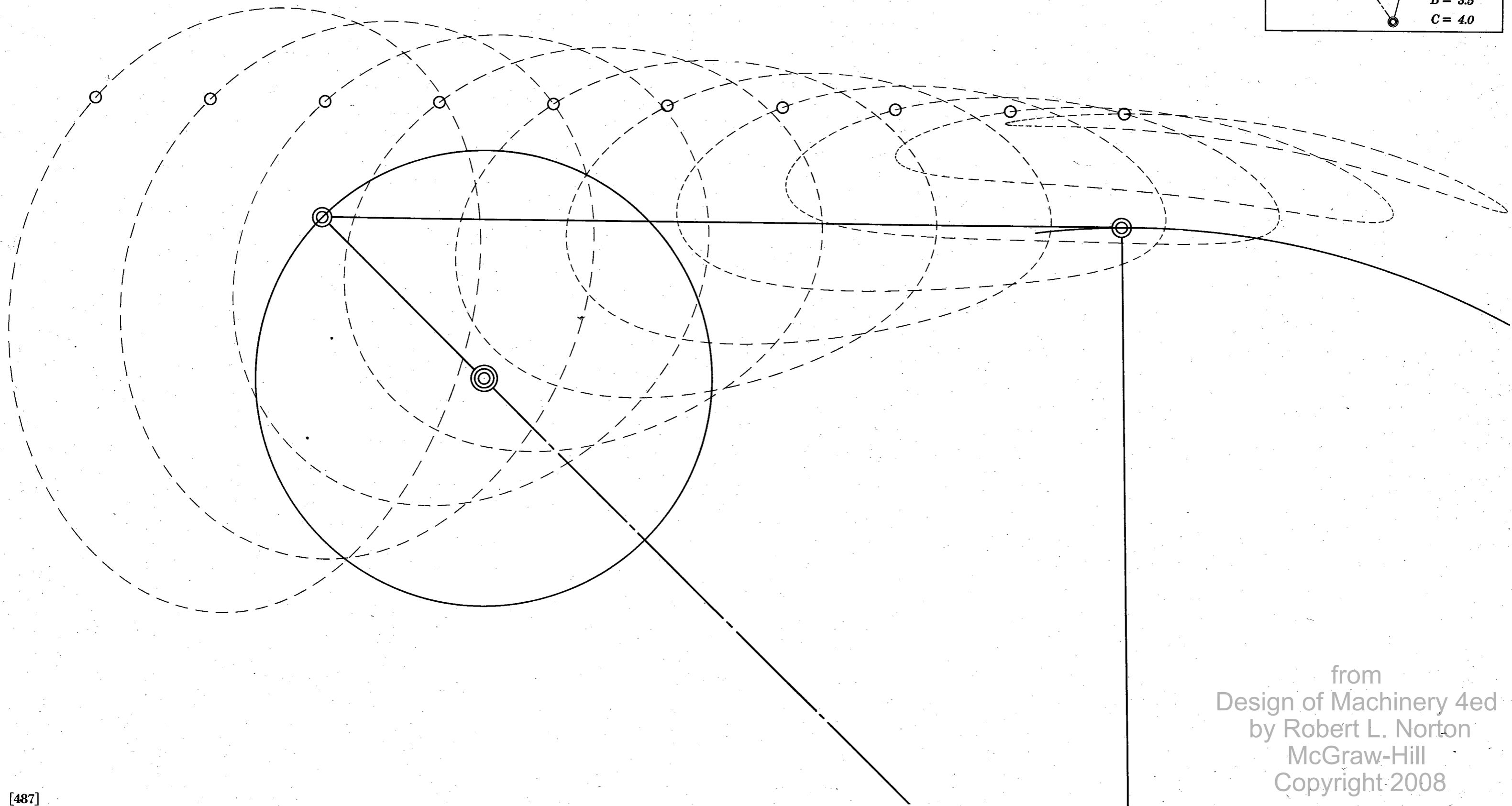

from  
 Design of Machinery 4ed  
 by Robert L. Norton  
 McGraw-Hill  
 Copyright 2008

**Analysis of the Four Bar Linkage**  
*J. A. Hrones and G. L. Nelson*

.....  
.....  
.....

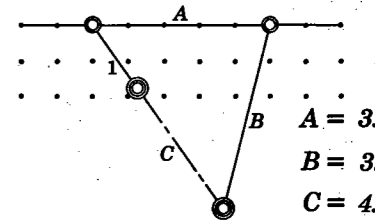

$A = 3.5$   
 $B = 3.5$   
 $C = 4.0$

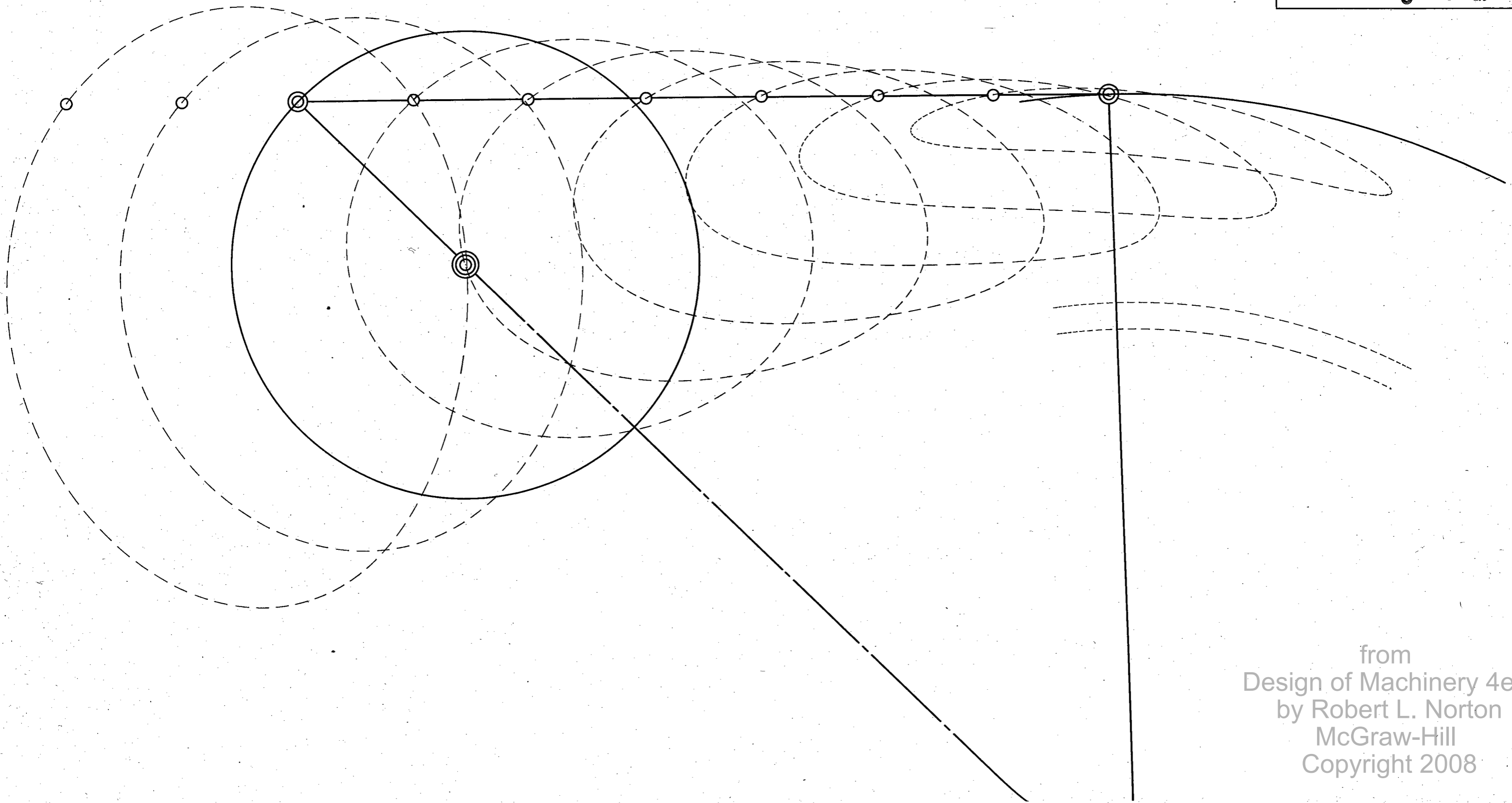

from  
Design of Machinery 4ed  
by Robert L. Norton  
McGraw-Hill  
Copyright 2008

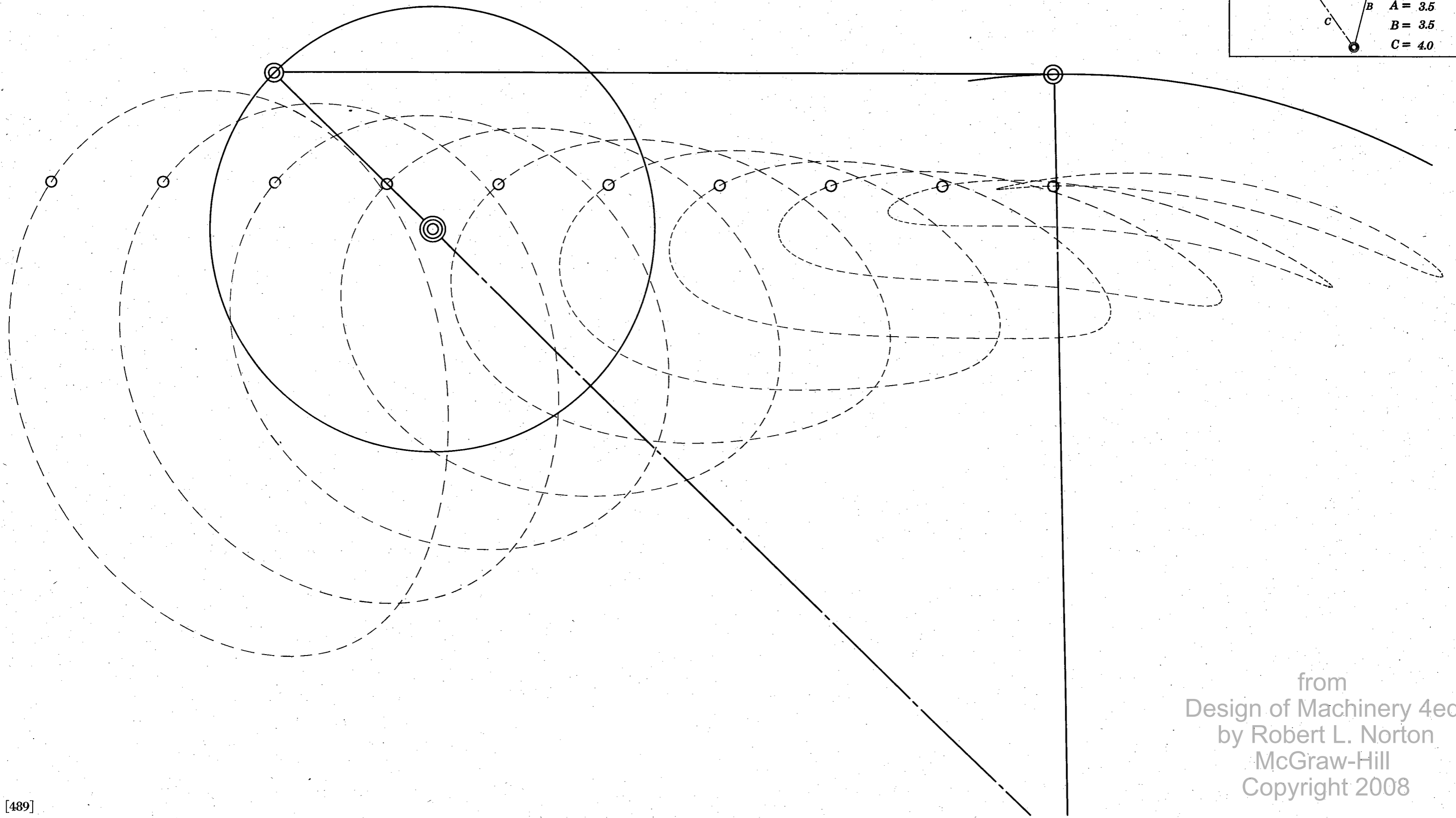
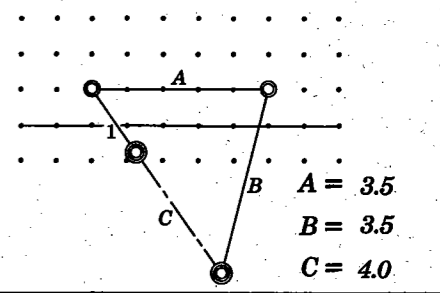

from  
Design of Machinery 4ed  
by Robert L. Norton  
McGraw-Hill  
Copyright 2008

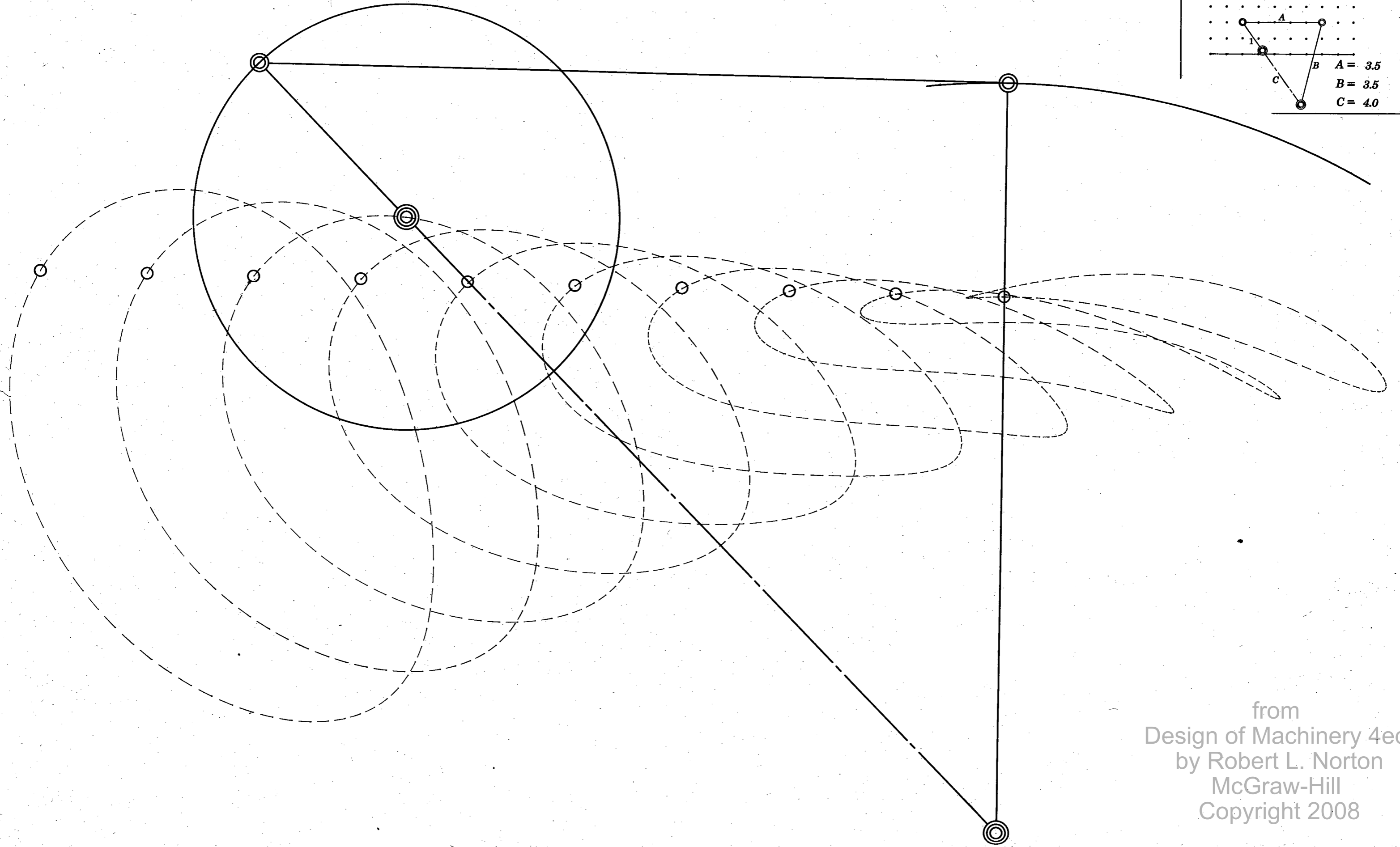
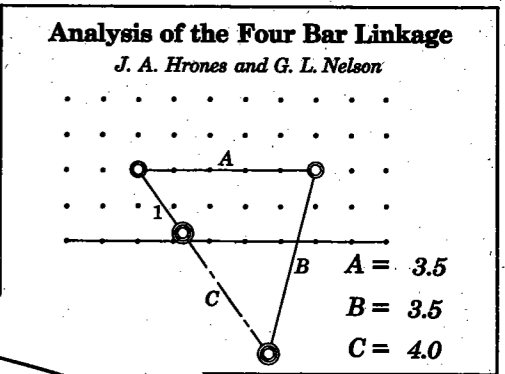

from  
Design of Machinery 4ed  
by Robert L. Norton  
McGraw-Hill  
Copyright 2008

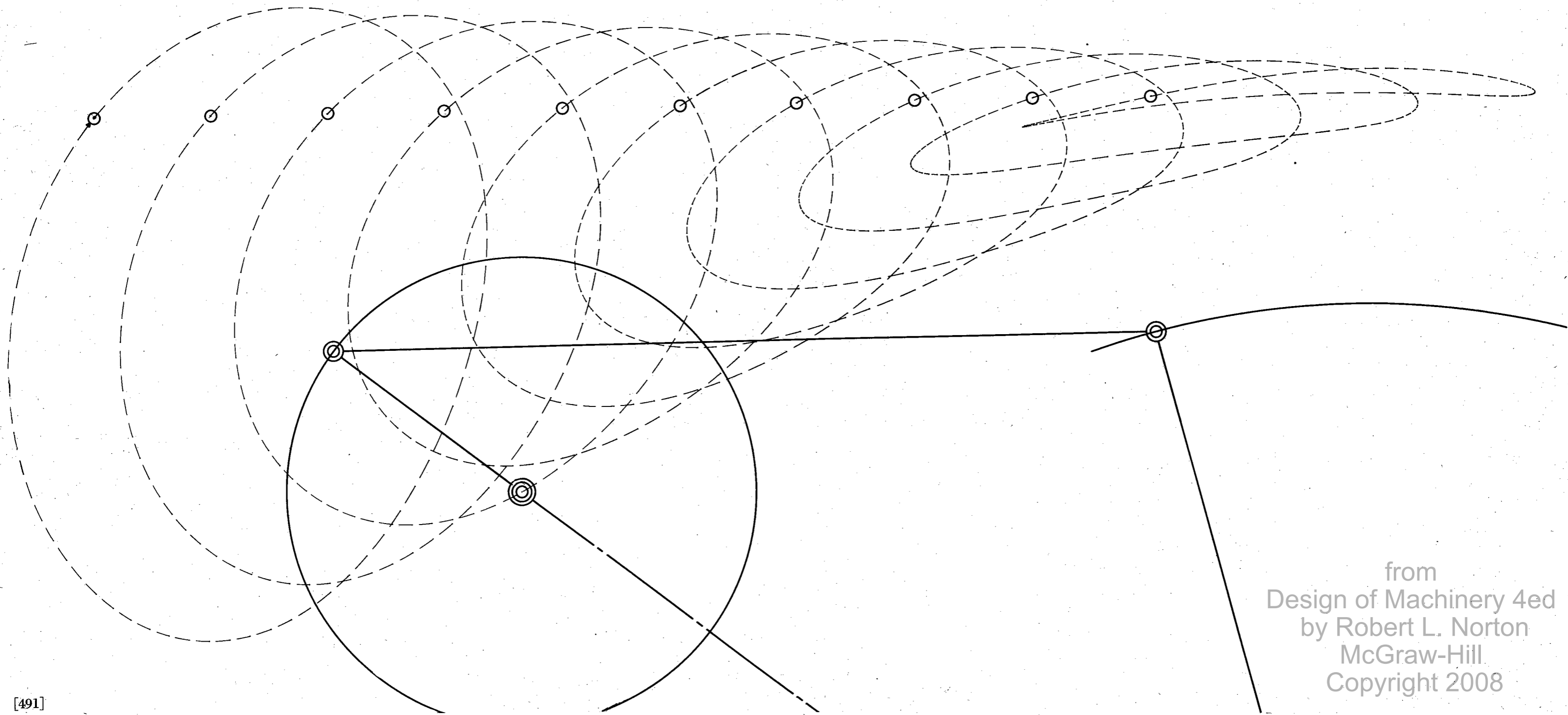
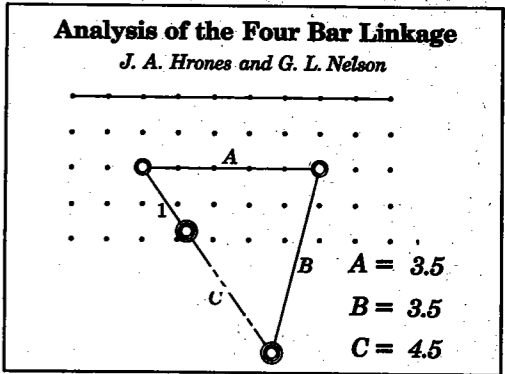

from  
 Design of Machinery 4ed  
 by Robert L. Norton  
 McGraw-Hill  
 Copyright 2008

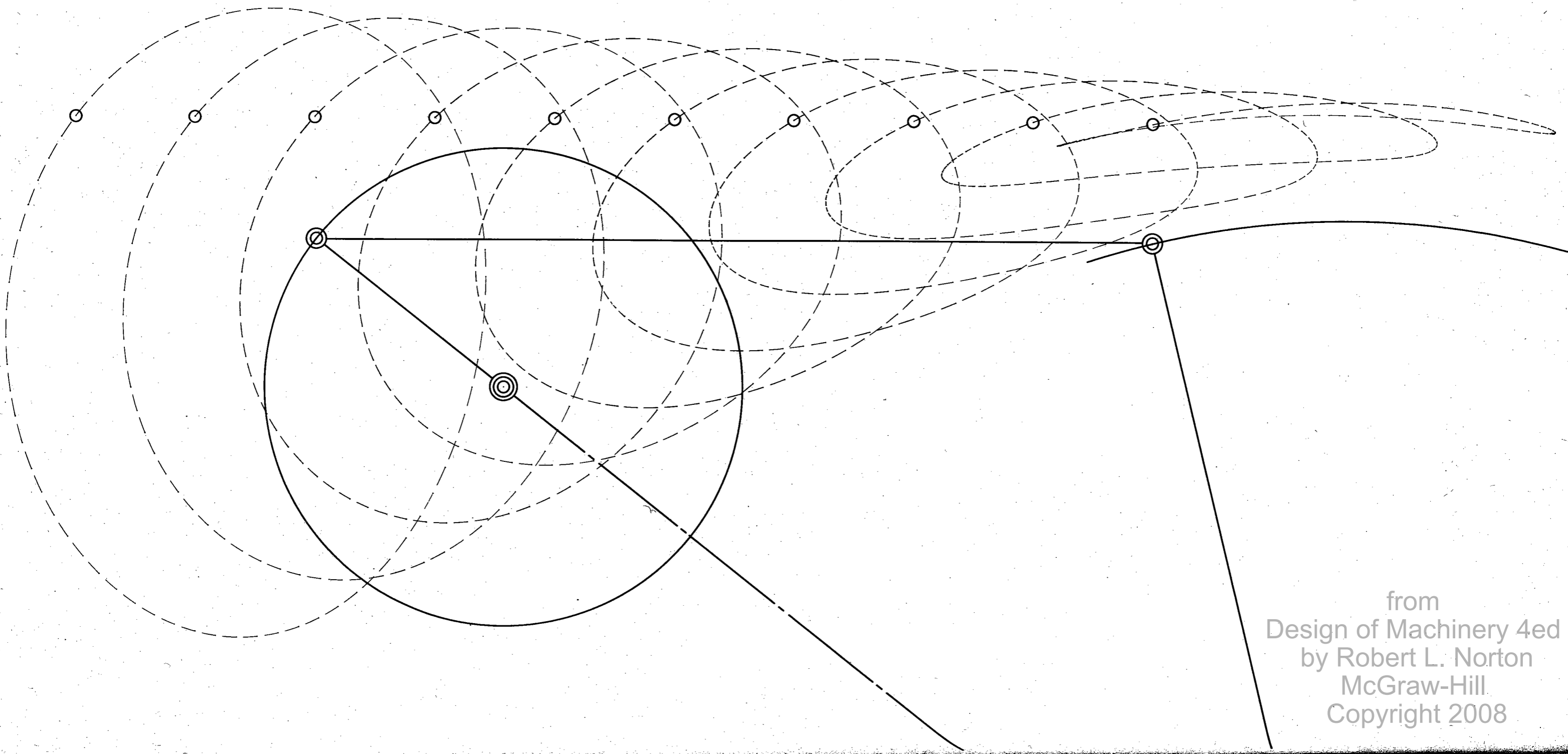
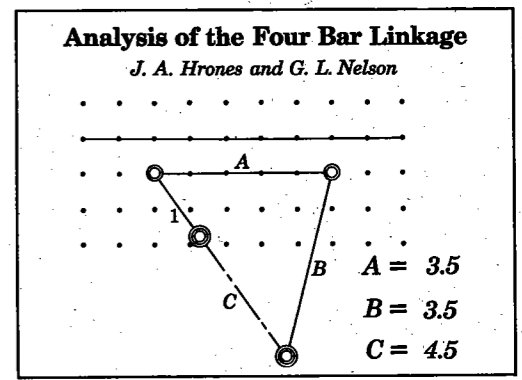

from  
Design of Machinery 4ed  
by Robert L. Norton  
McGraw-Hill  
Copyright 2008

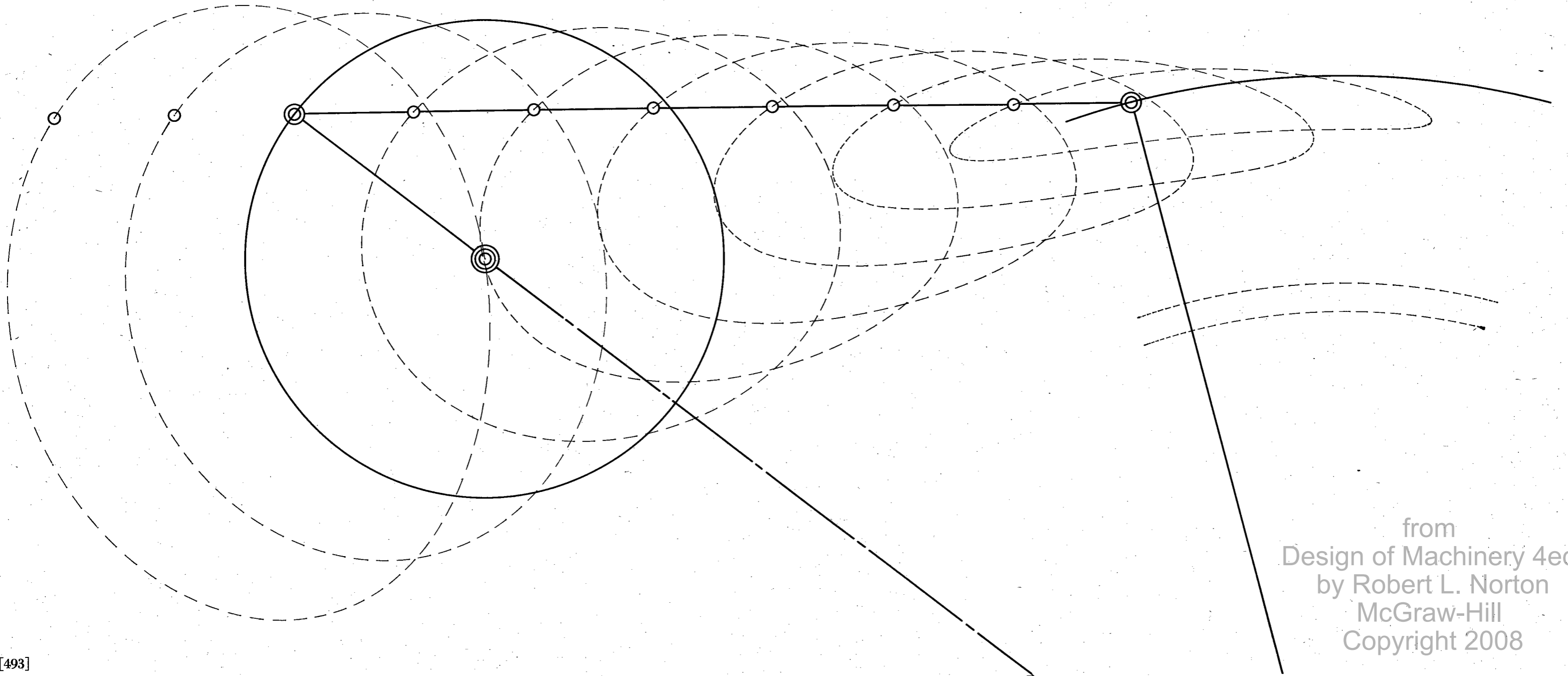
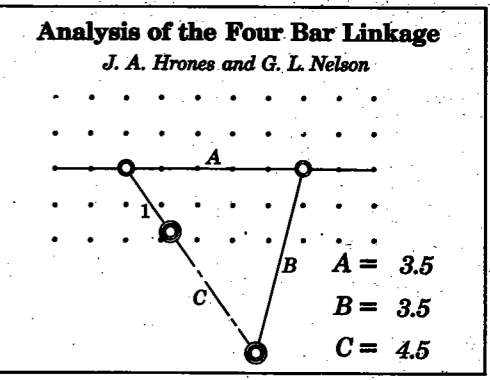

from  
 Design of Machinery 4ed  
 by Robert L. Norton  
 McGraw-Hill  
 Copyright 2008



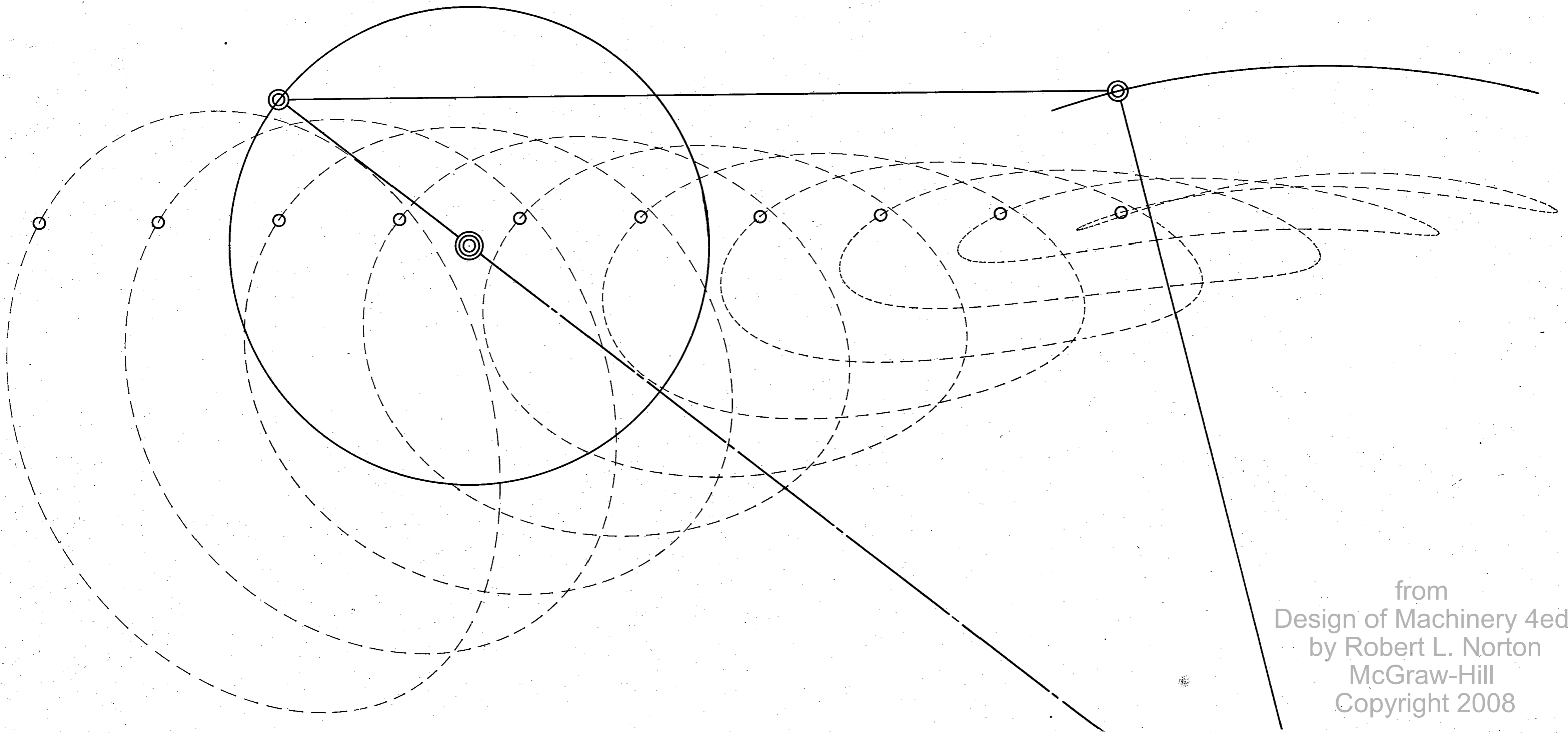
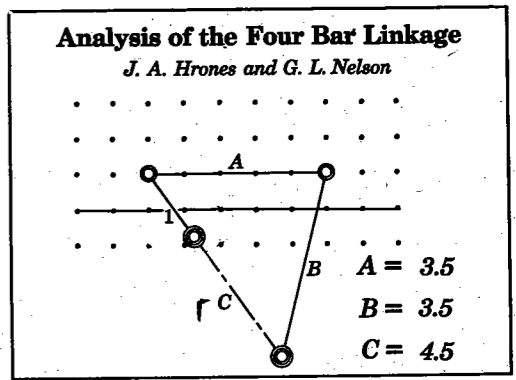

from  
Design of Machinery 4ed  
by Robert L. Norton  
McGraw-Hill  
Copyright 2008

**Analysis of the Four Bar Linkage**

*J. A. Hrones and G. L. Nelson*

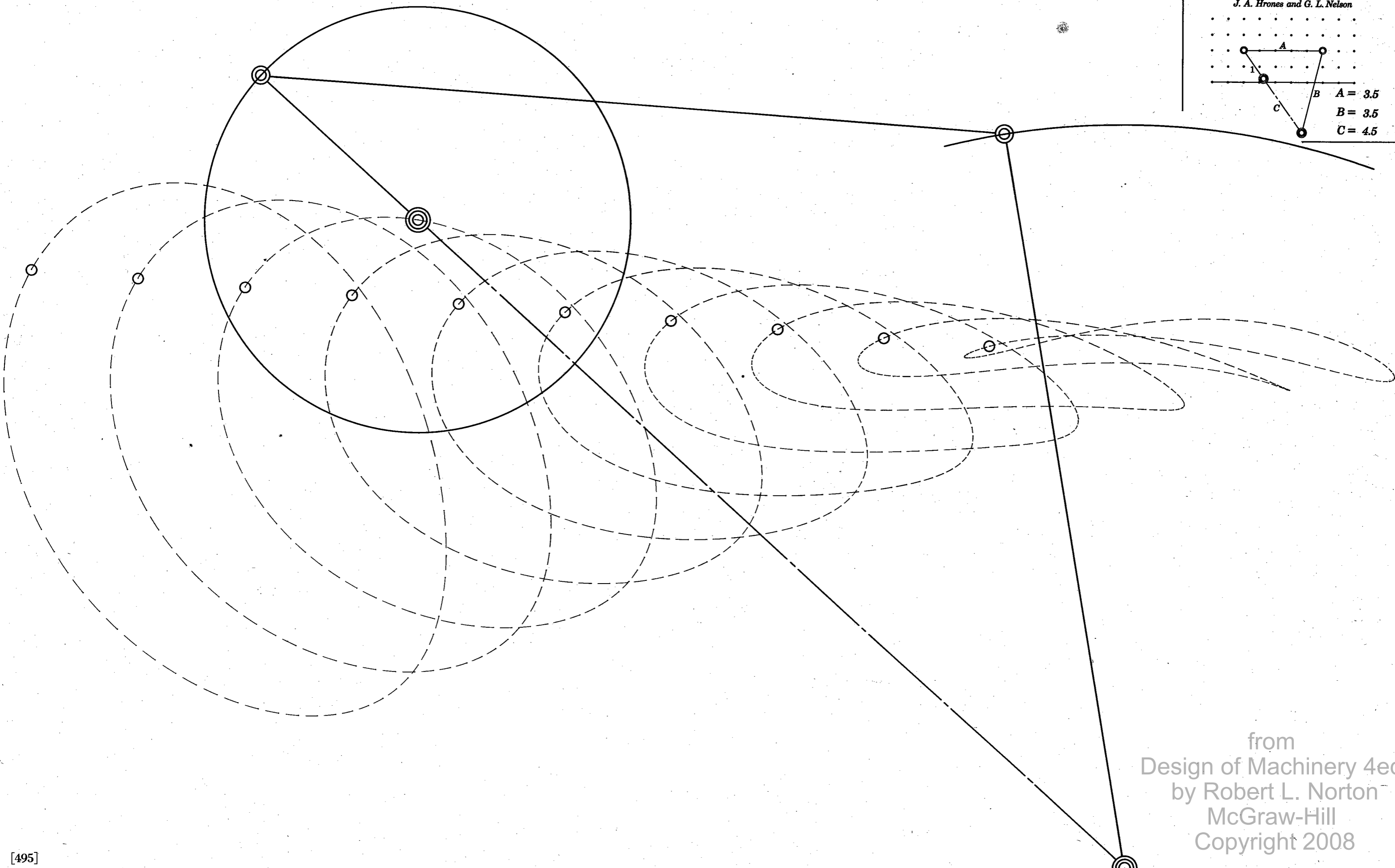
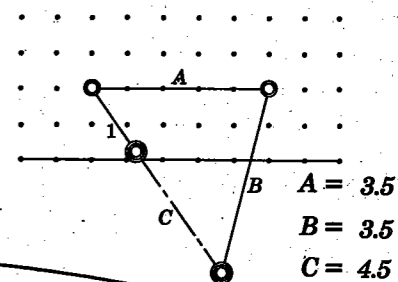

from  
Design of Machinery 4ed  
by Robert L. Norton  
McGraw-Hill  
Copyright 2008

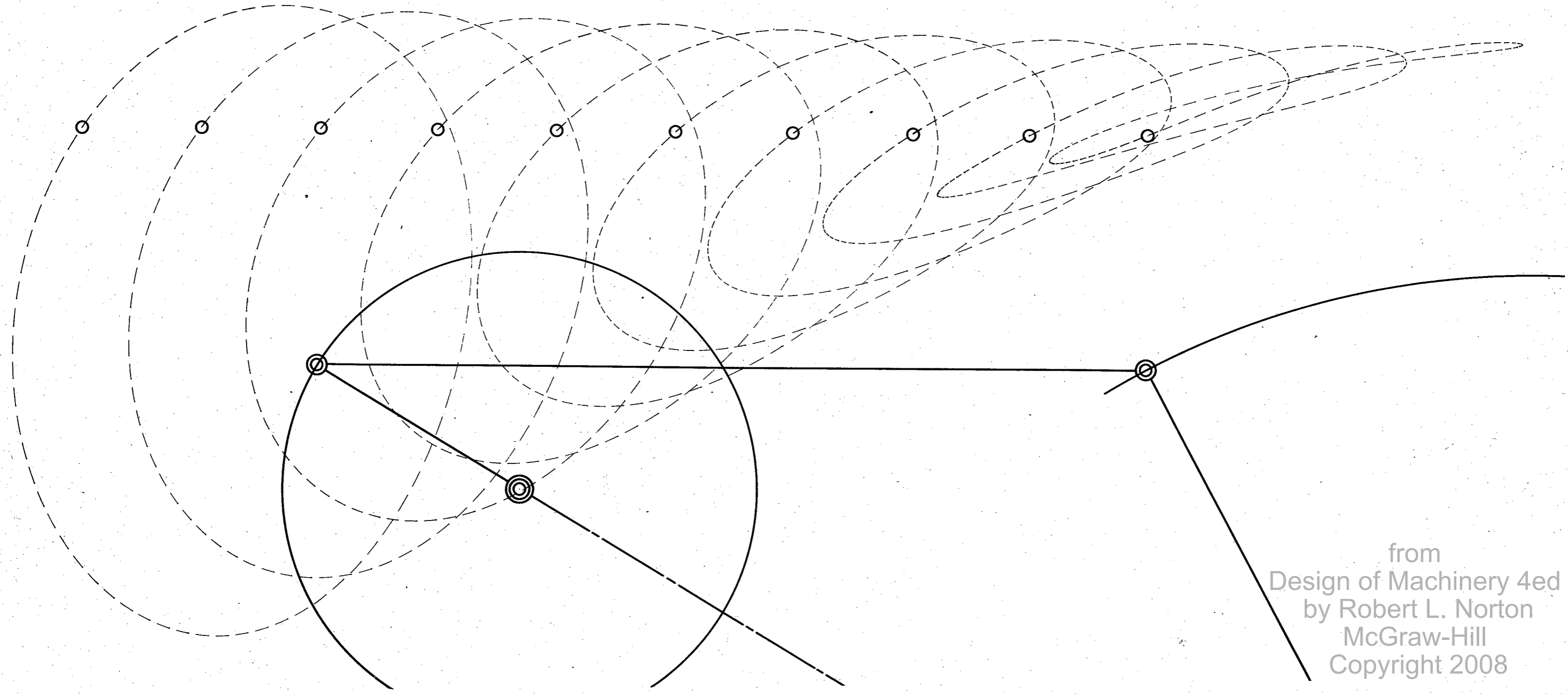
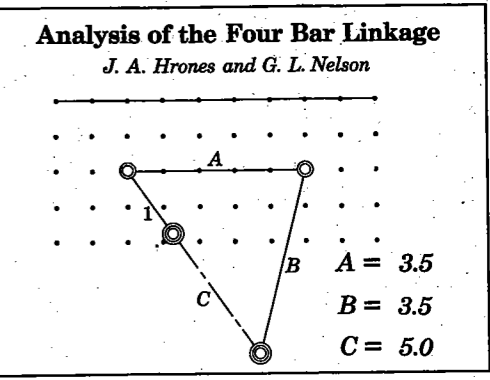

from  
Design of Machinery 4ed  
by Robert L. Norton  
McGraw-Hill  
Copyright 2008

**Analysis of the Four Bar Linkage**

*J. A. Hrones and G. L. Nelson*

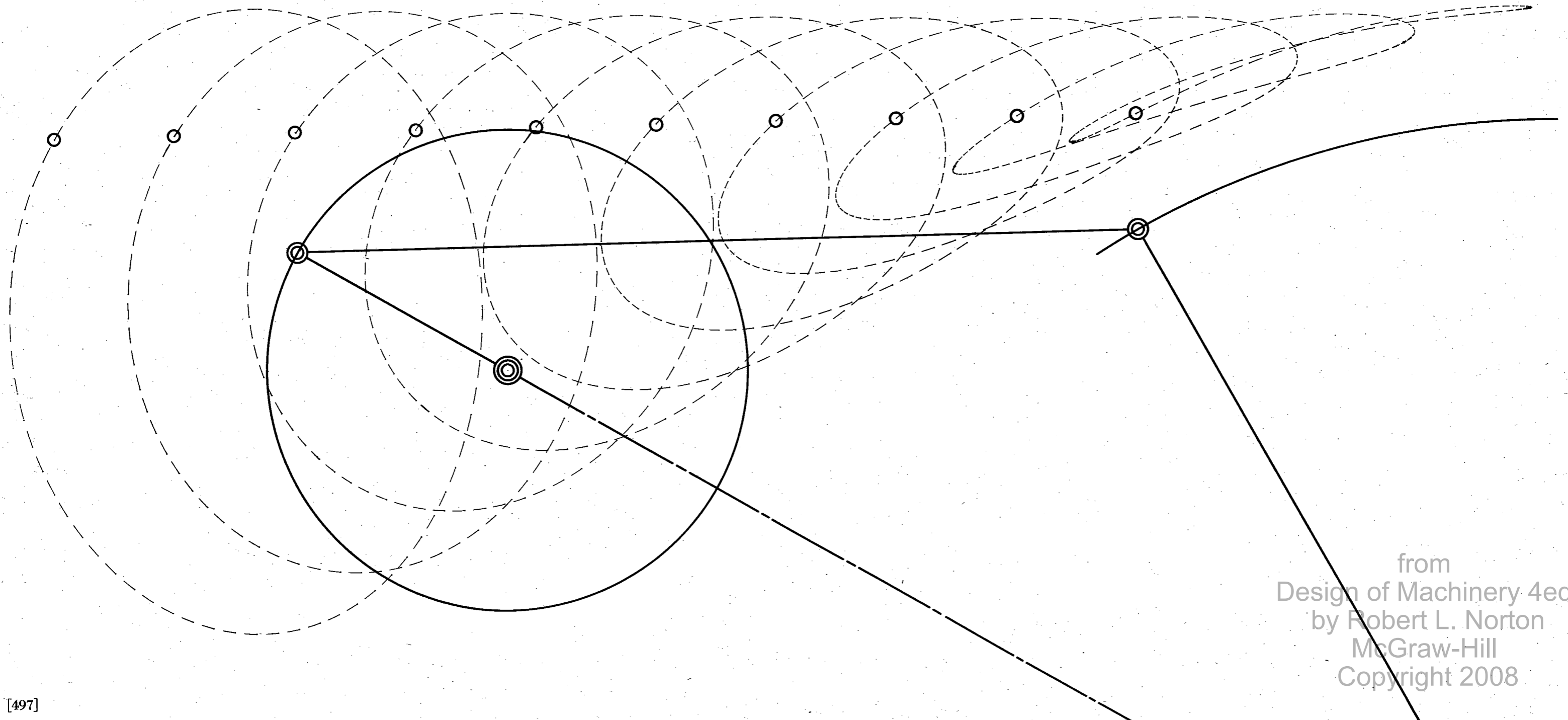
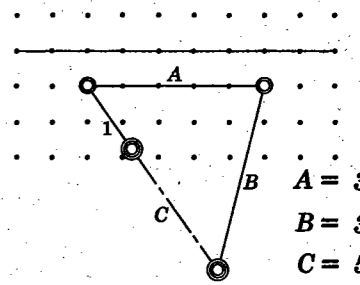

from  
Design of Machinery 4ed  
by Robert L. Norton  
McGraw-Hill  
Copyright 2008

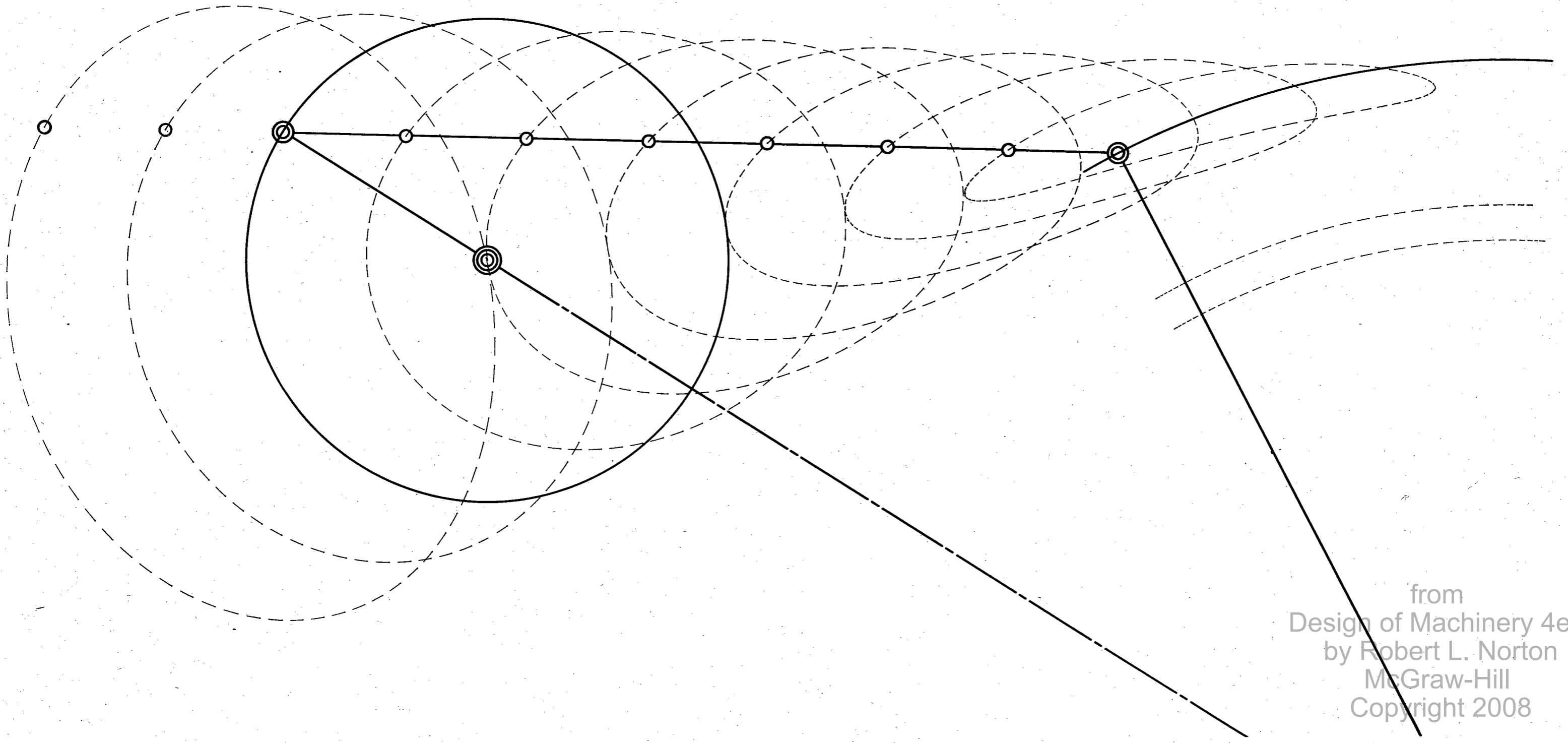
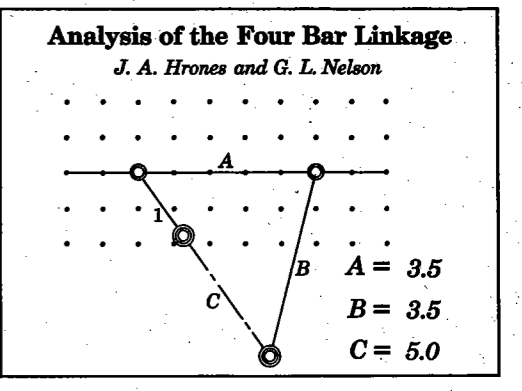

from  
Design of Machinery 4ed  
by Robert L. Norton  
McGraw-Hill  
Copyright 2008

**Analysis of the Four Bar Linkage**  
*J. A. Hrones and G. L. Nelson*

$A = 3.5$   
 $B = 3.5$   
 $C = 5.0$

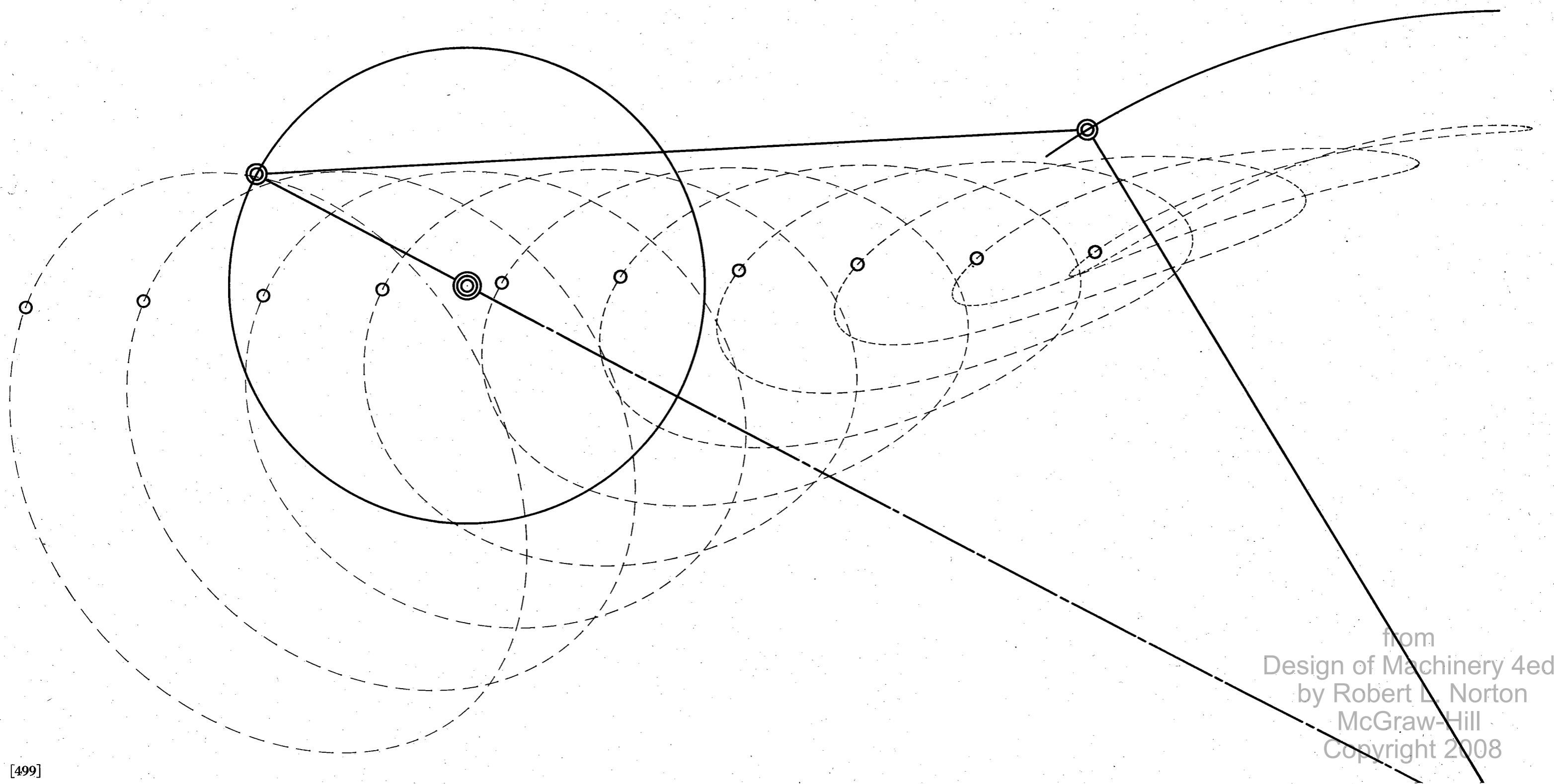

from  
 Design of Machinery 4ed  
 by Robert L. Norton  
 McGraw-Hill  
 Copyright 2008

**Analysis of the Four Bar Linkage**  
*J. A. Hrones and G. L. Nelson*

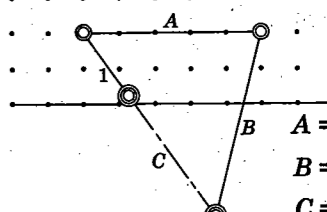

$A = 3.5$   
 $B = 3.5$   
 $C = 5.0$

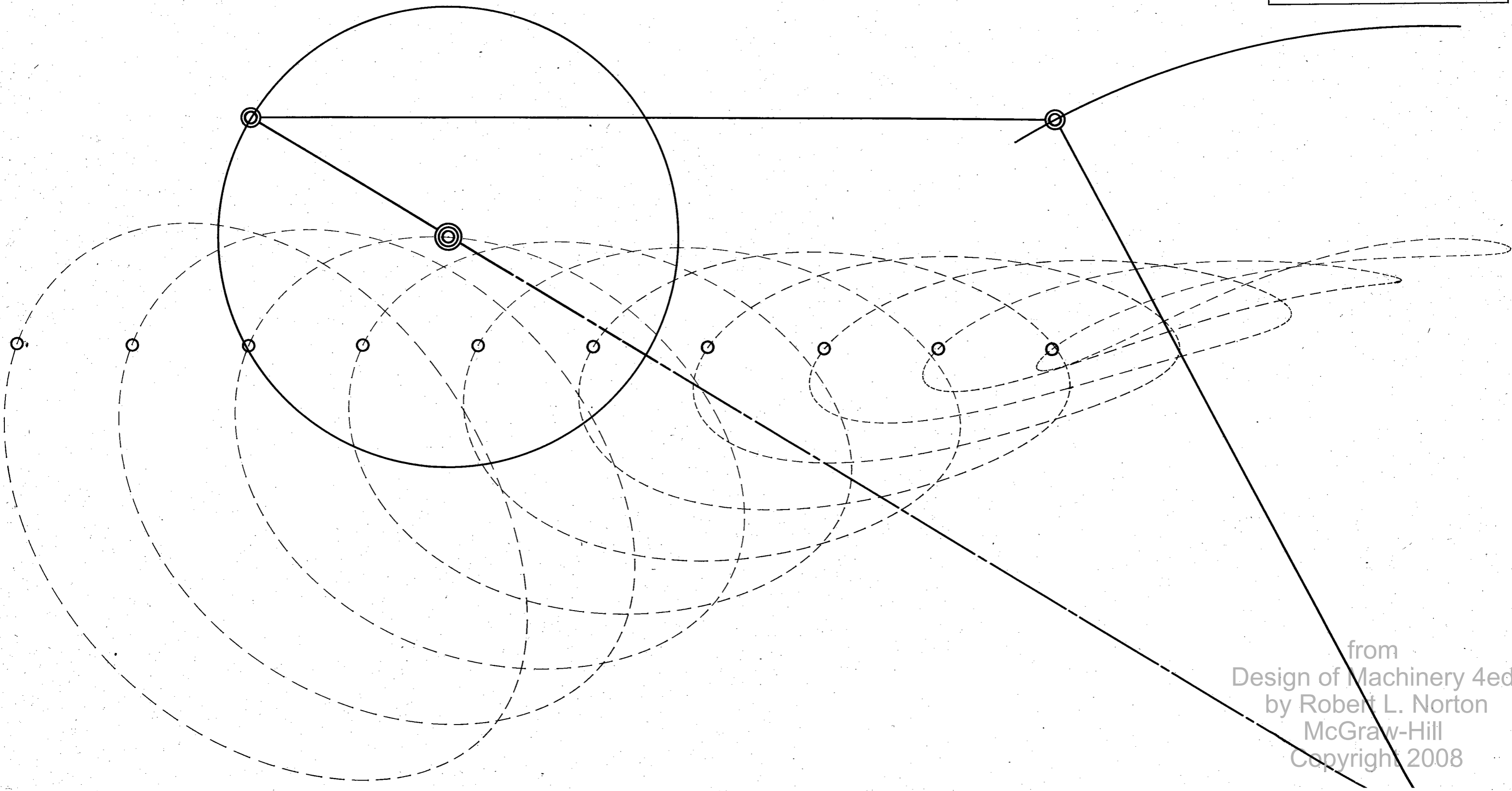

from  
Design of Machinery 4ed  
by Robert L. Norton  
McGraw-Hill  
Copyright 2008

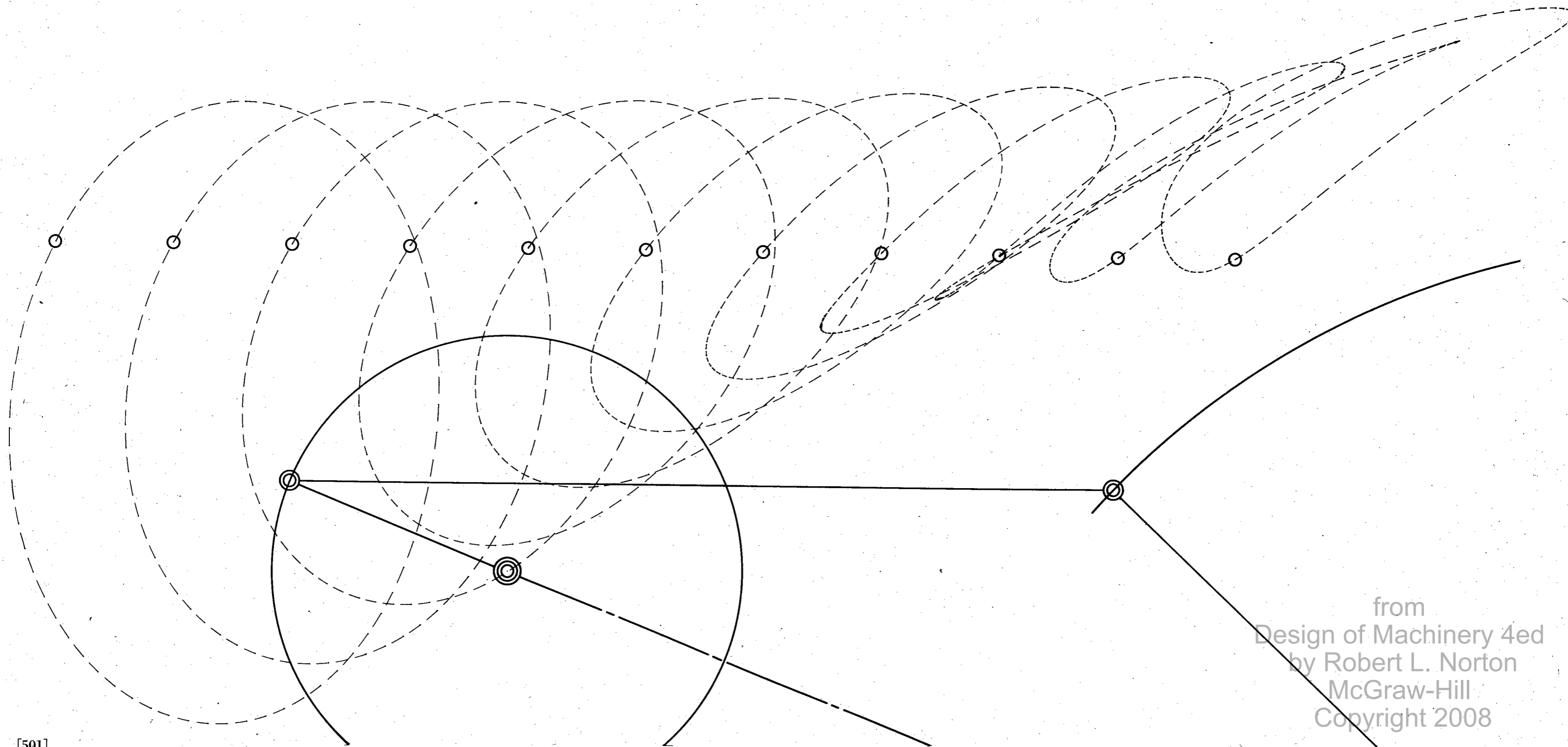
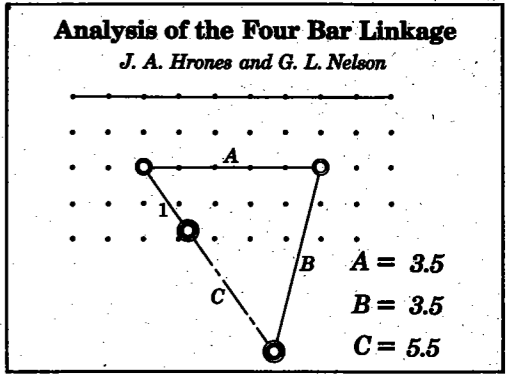

from  
 Design of Machinery 4ed  
 by Robert L. Norton  
 McGraw-Hill  
 Copyright 2008



**Analysis of the Four Bar Linkage**  
*J. A. Hrones and G. L. Nelson*

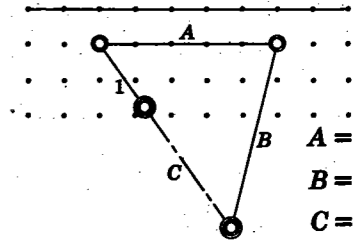

$A = 3.5$   
 $B = 3.5$   
 $C = 5.5$

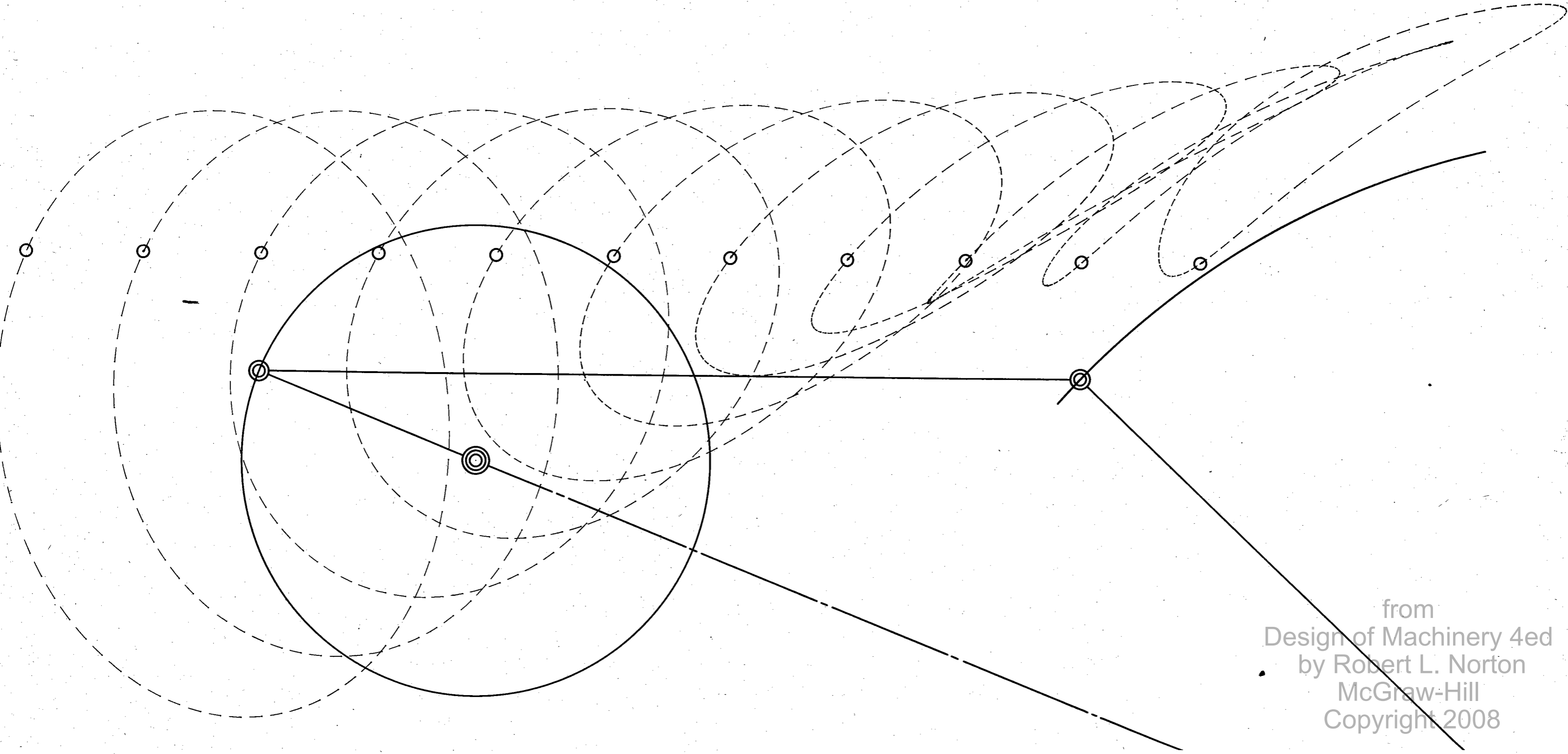

from  
Design of Machinery 4ed  
by Robert L. Norton  
McGraw-Hill  
Copyright 2008

**Analysis of the Four Bar Linkage**

*J. A. Hrones and G. L. Nelson*



**A = 3.5**  
**B = 3.5**  
**C = 5.5**

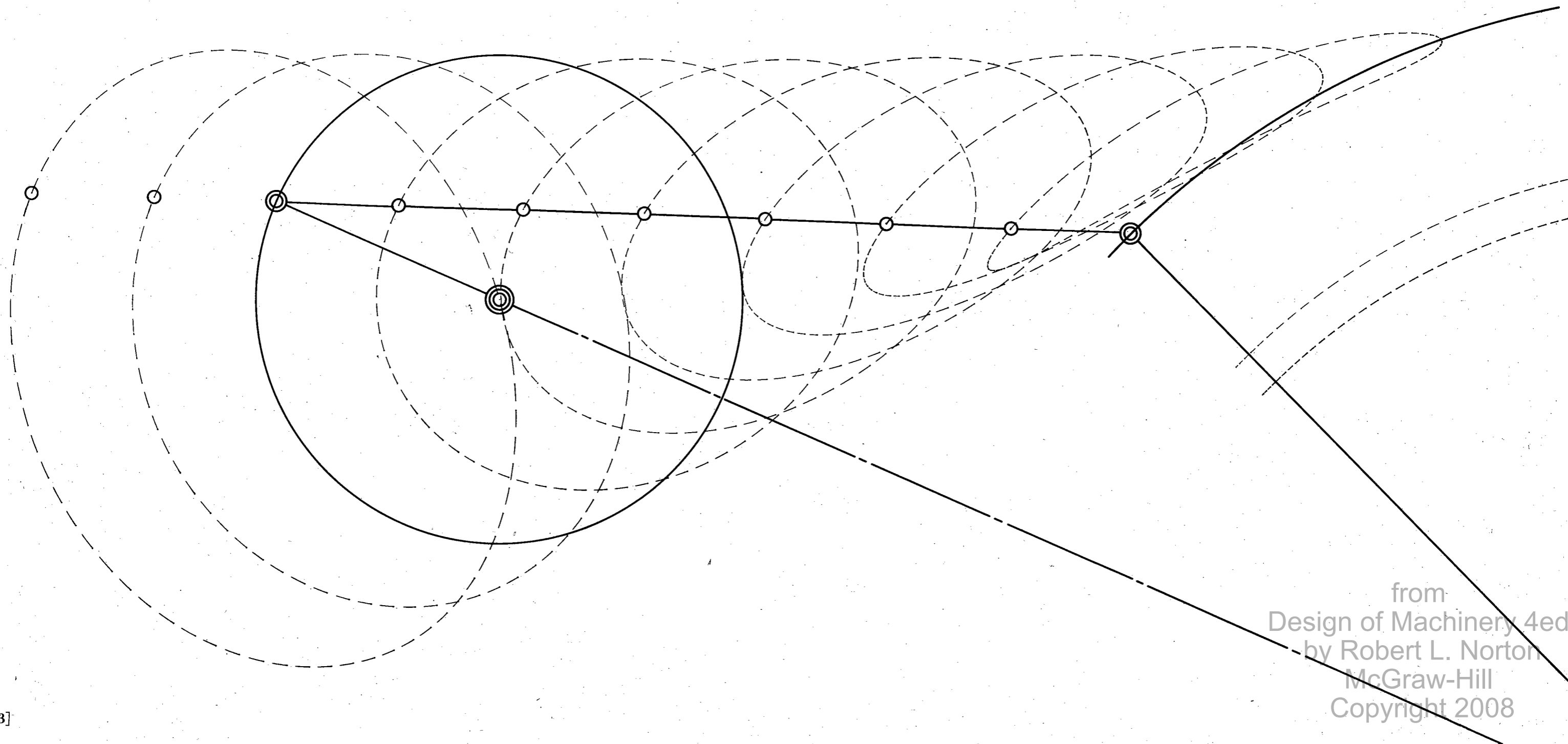

from  
Design of Machinery 4ed  
by Robert L. Norton  
McGraw-Hill  
Copyright 2008

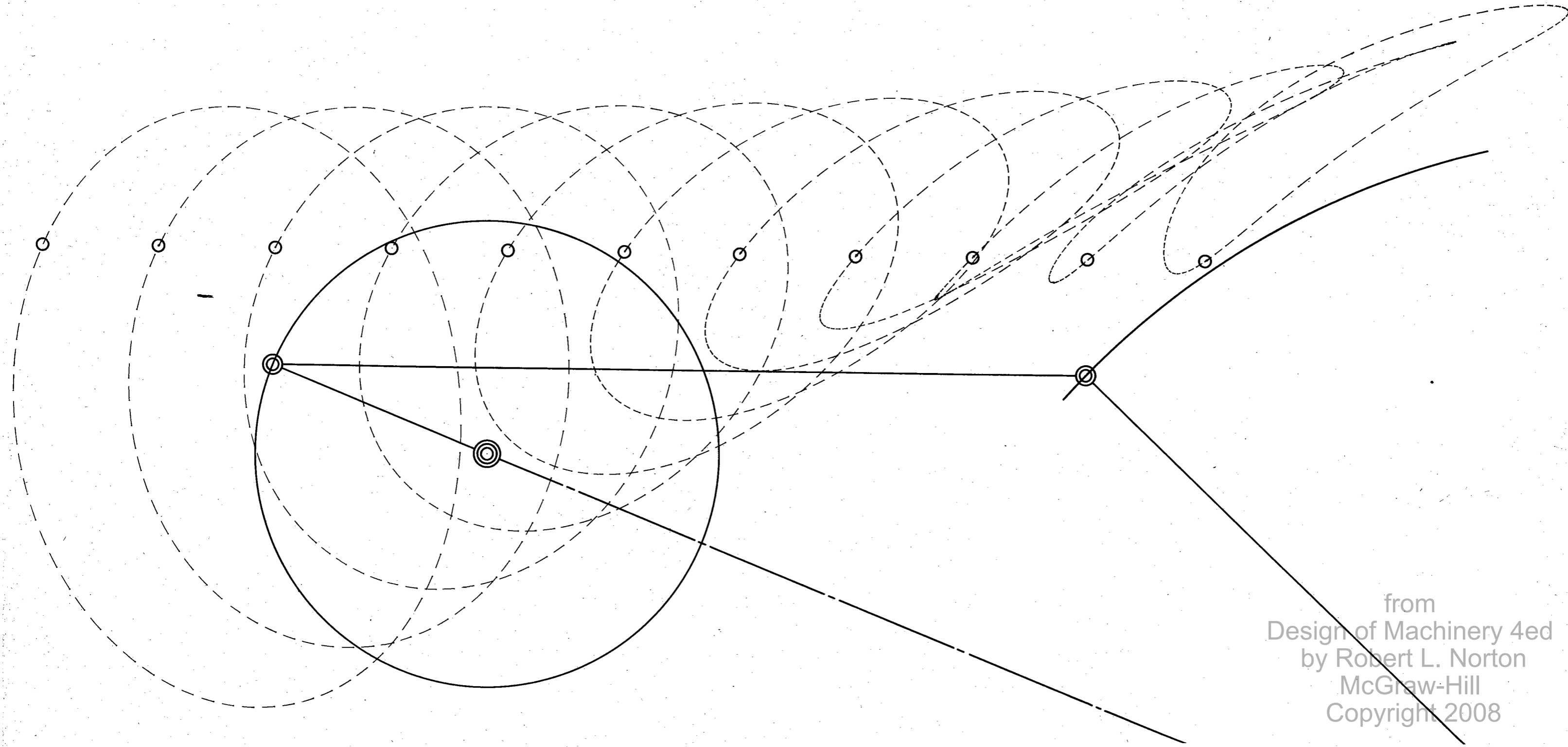
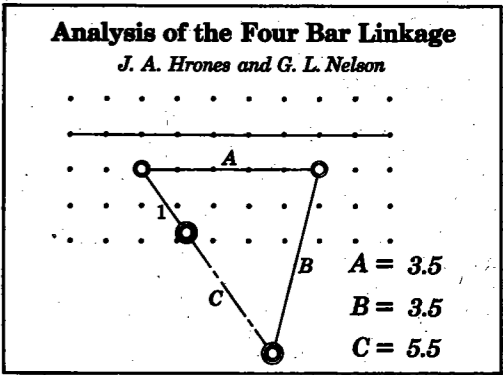

from  
Design of Machinery 4ed  
by Robert L. Norton  
McGraw-Hill  
Copyright 2008

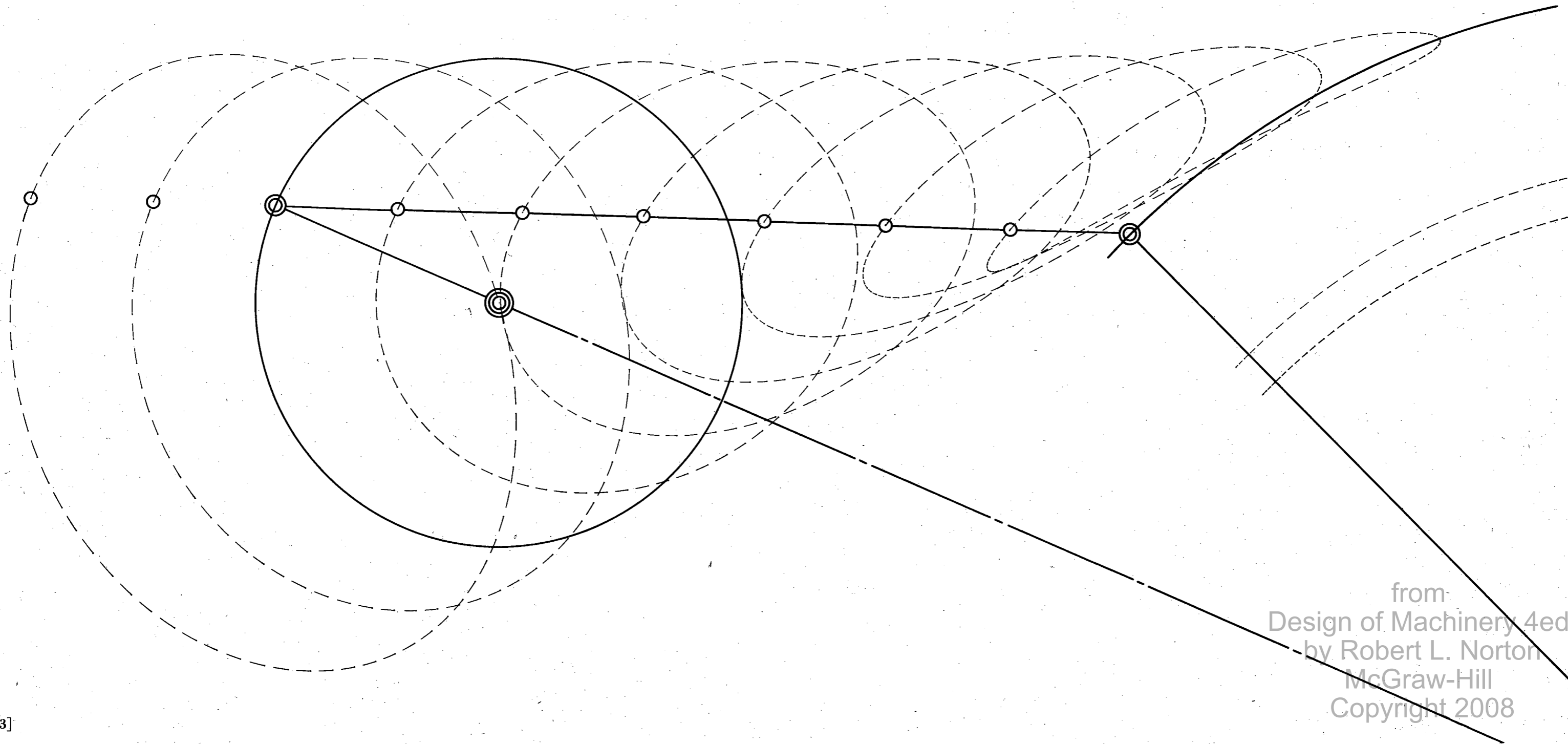
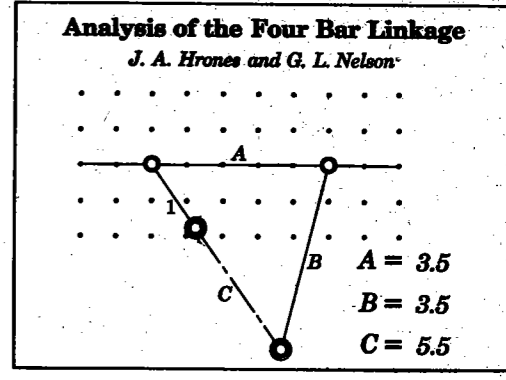

from  
 Design of Machinery 4ed  
 by Robert L. Norton  
 McGraw-Hill  
 Copyright 2008

**Analysis of the Four Bar Linkage**

*J. A. Hrones and G. L. Nelson*

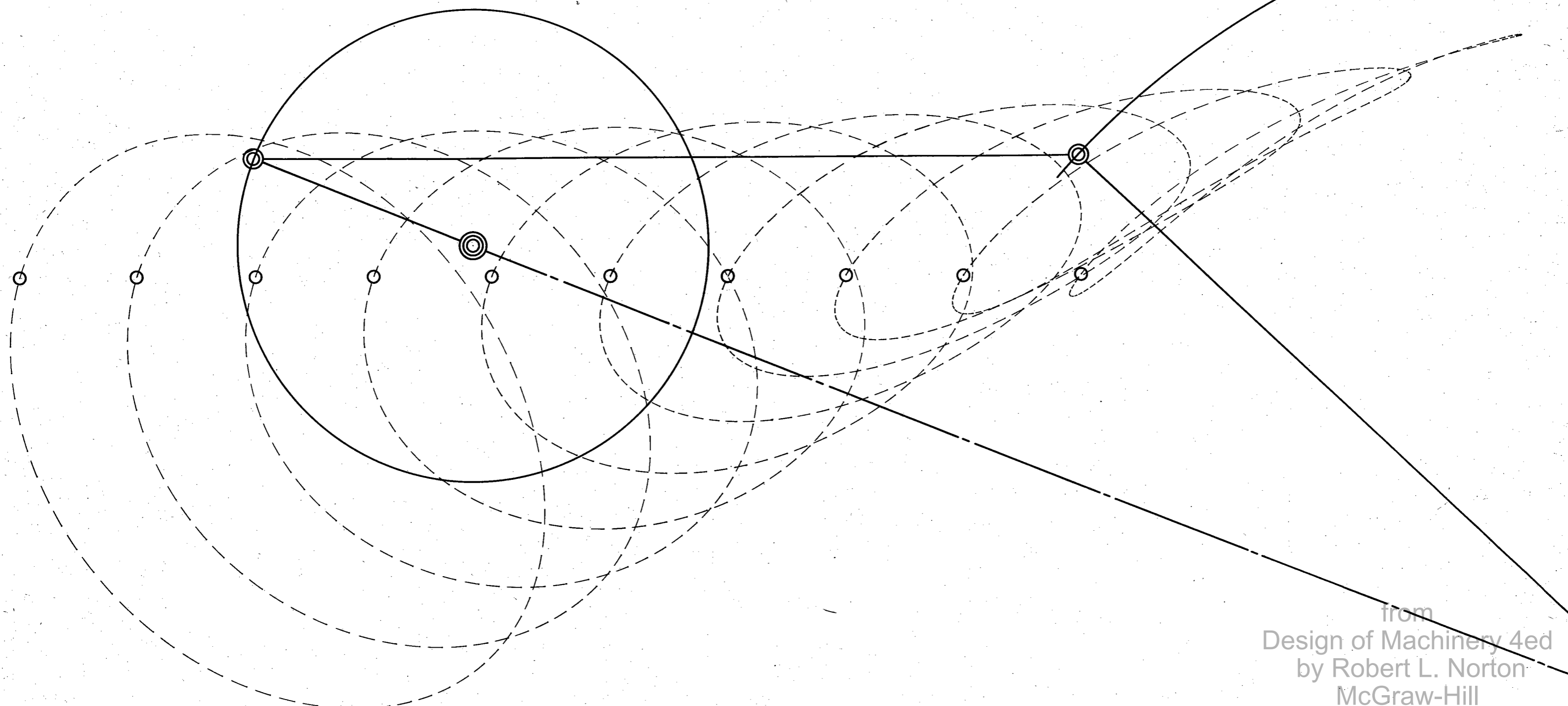
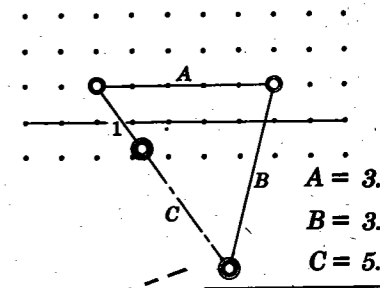

from  
Design of Machinery 4ed  
by Robert L. Norton  
McGraw-Hill  
Copyright 2008

**Analysis of the Four Bar Linkage**  
*J. A. Hrones and G. L. Nelson*

$A = 3.5$   
 $B = 3.5$   
 $C = 5.5$

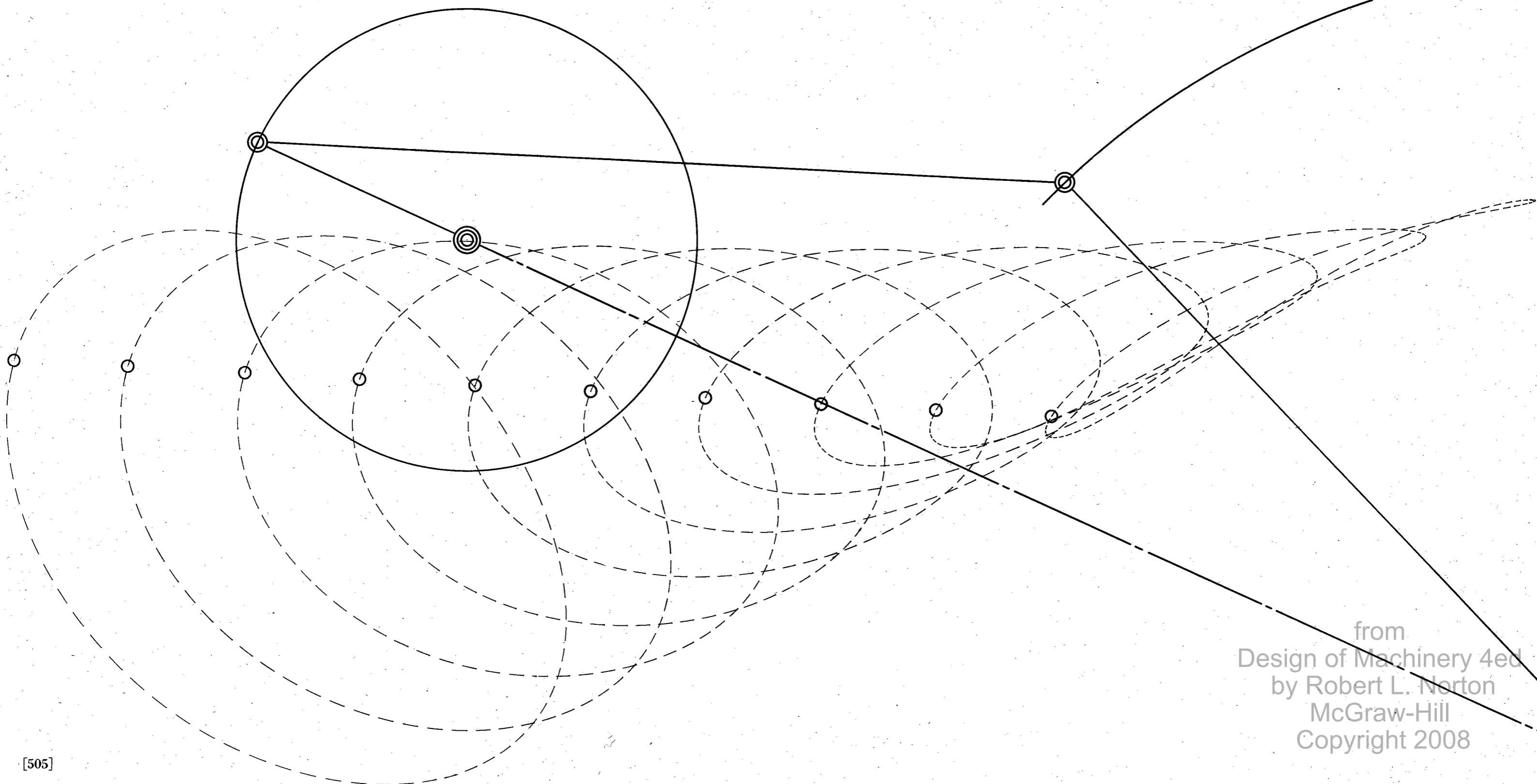

from  
 Design of Machinery 4ed  
 by Robert L. Norton  
 McGraw-Hill  
 Copyright 2008

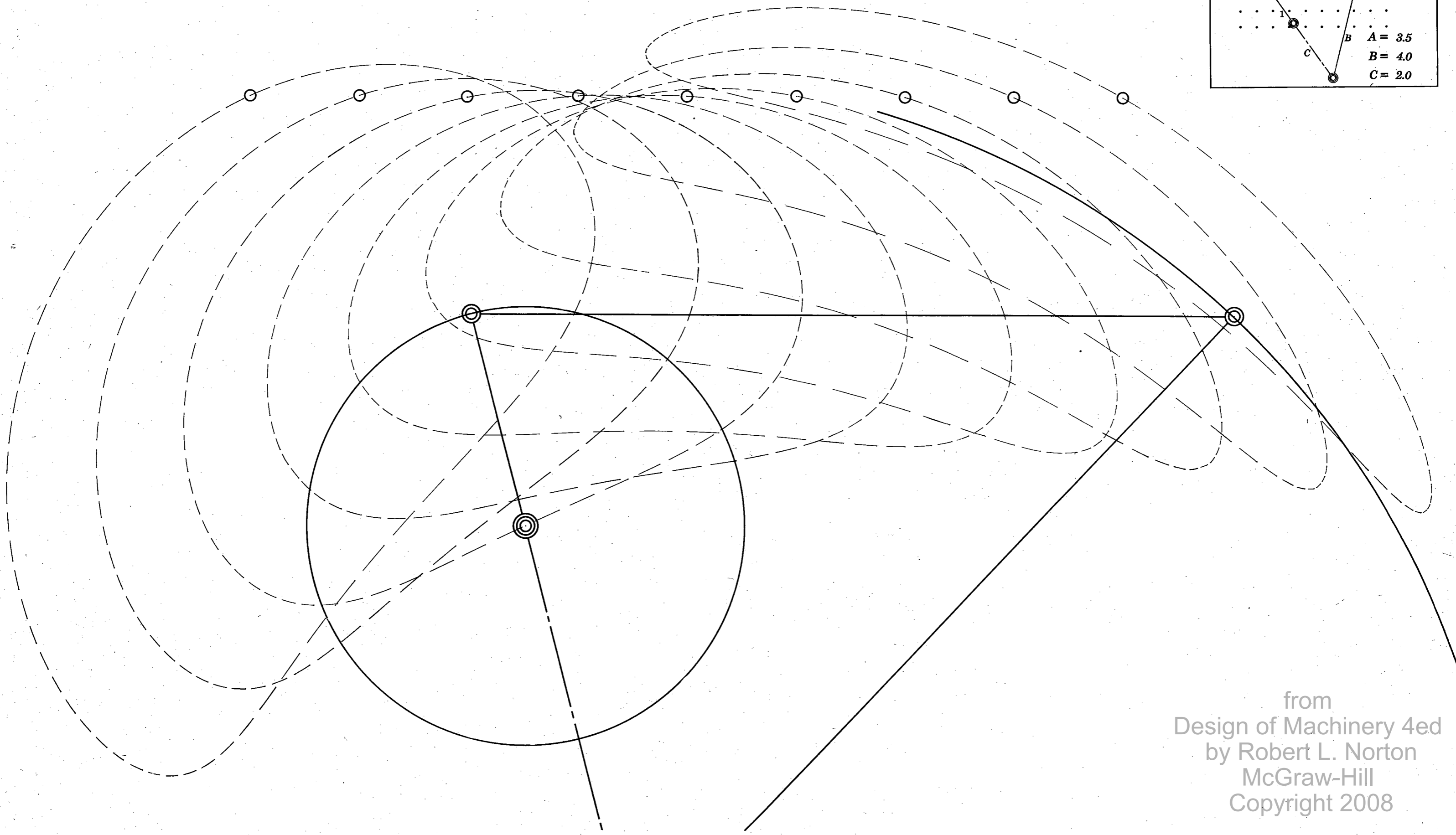
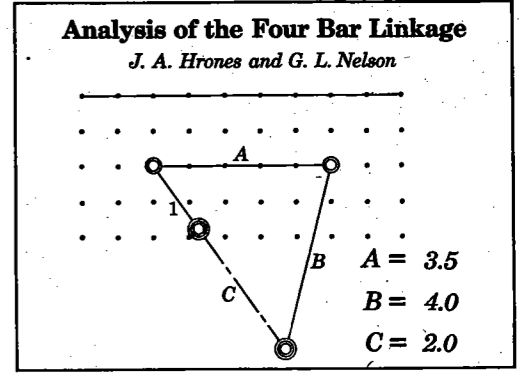

from  
Design of Machinery 4ed  
by Robert L. Norton  
McGraw-Hill  
Copyright 2008

**Analysis of the Four Bar Linkage**  
*J. A. Hrones and G. L. Nelson*

$A = 3.5$   
 $B = 4.0$   
 $C = 2.0$

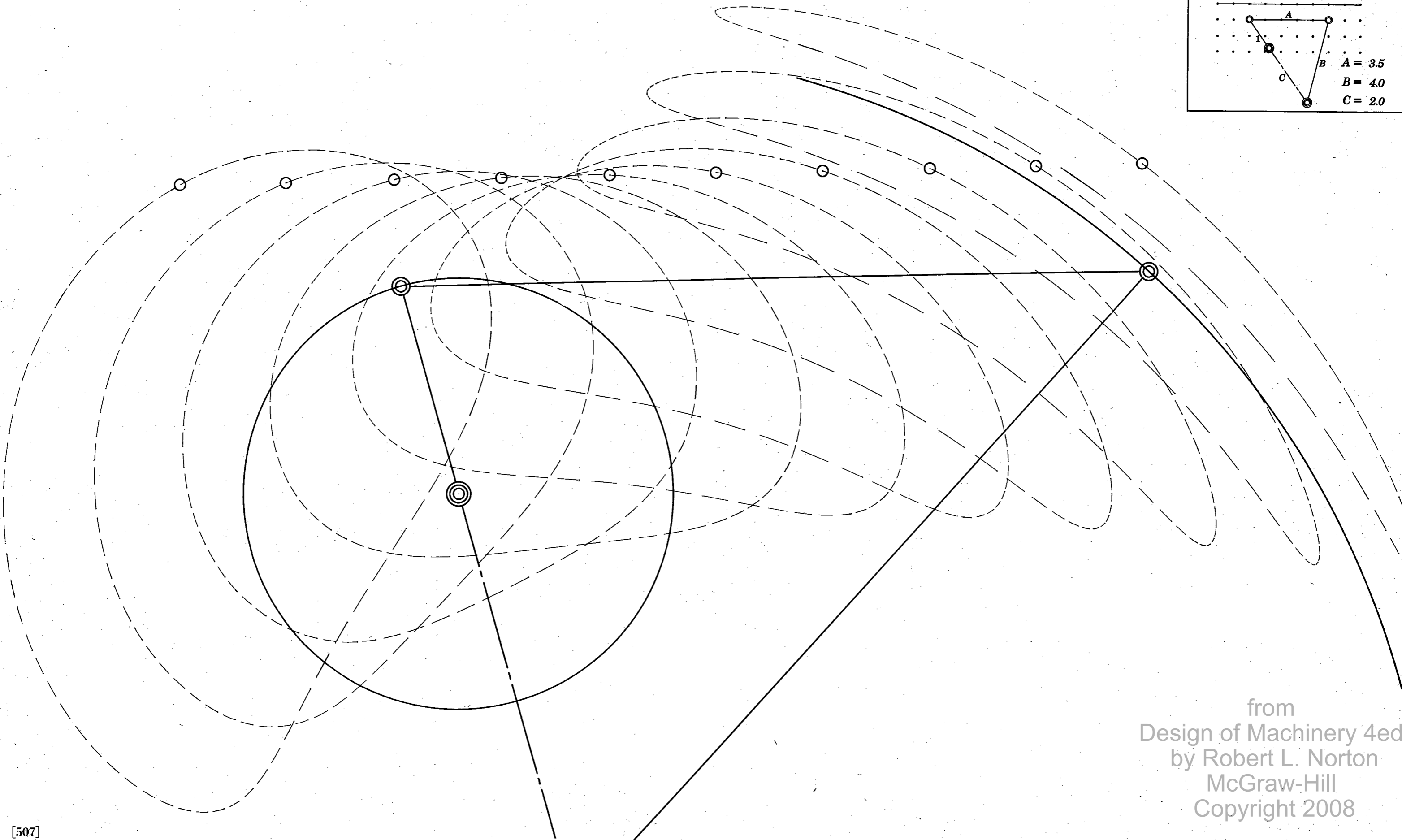

from  
 Design of Machinery 4ed  
 by Robert L. Norton  
 McGraw-Hill  
 Copyright 2008



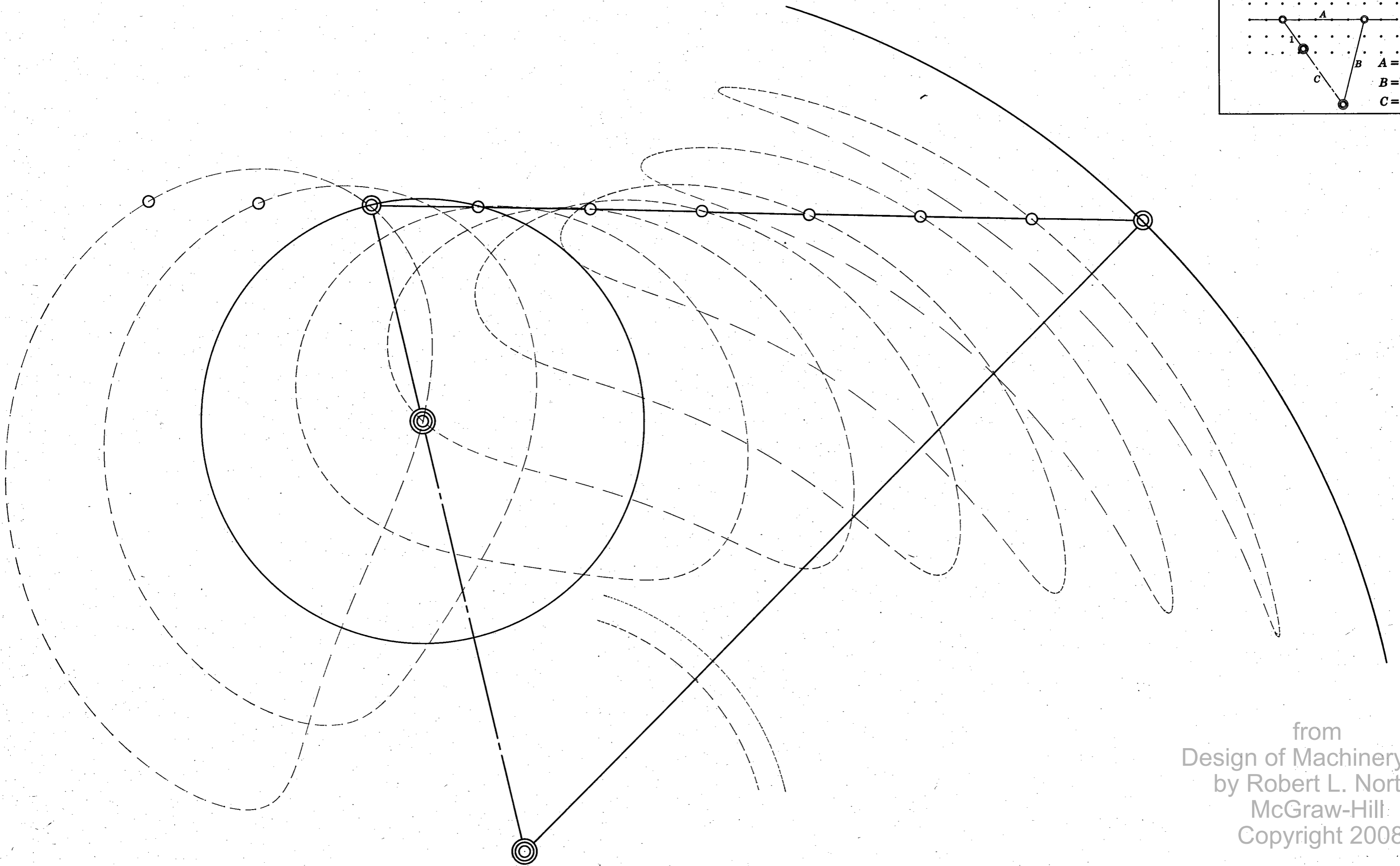
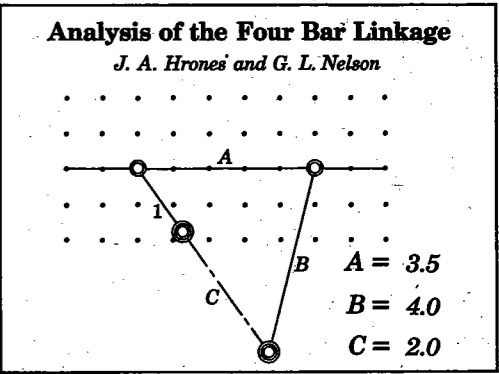

from  
Design of Machinery 4ed  
by Robert L. Norton  
McGraw-Hill  
Copyright 2008

**Analysis of the Four Bar Linkage**  
*J. A. Hrones and G. L. Nelson*

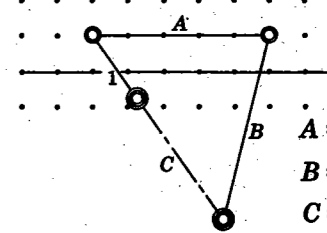

$A = 3.5$   
 $B = 4.0$   
 $C = 2.0$

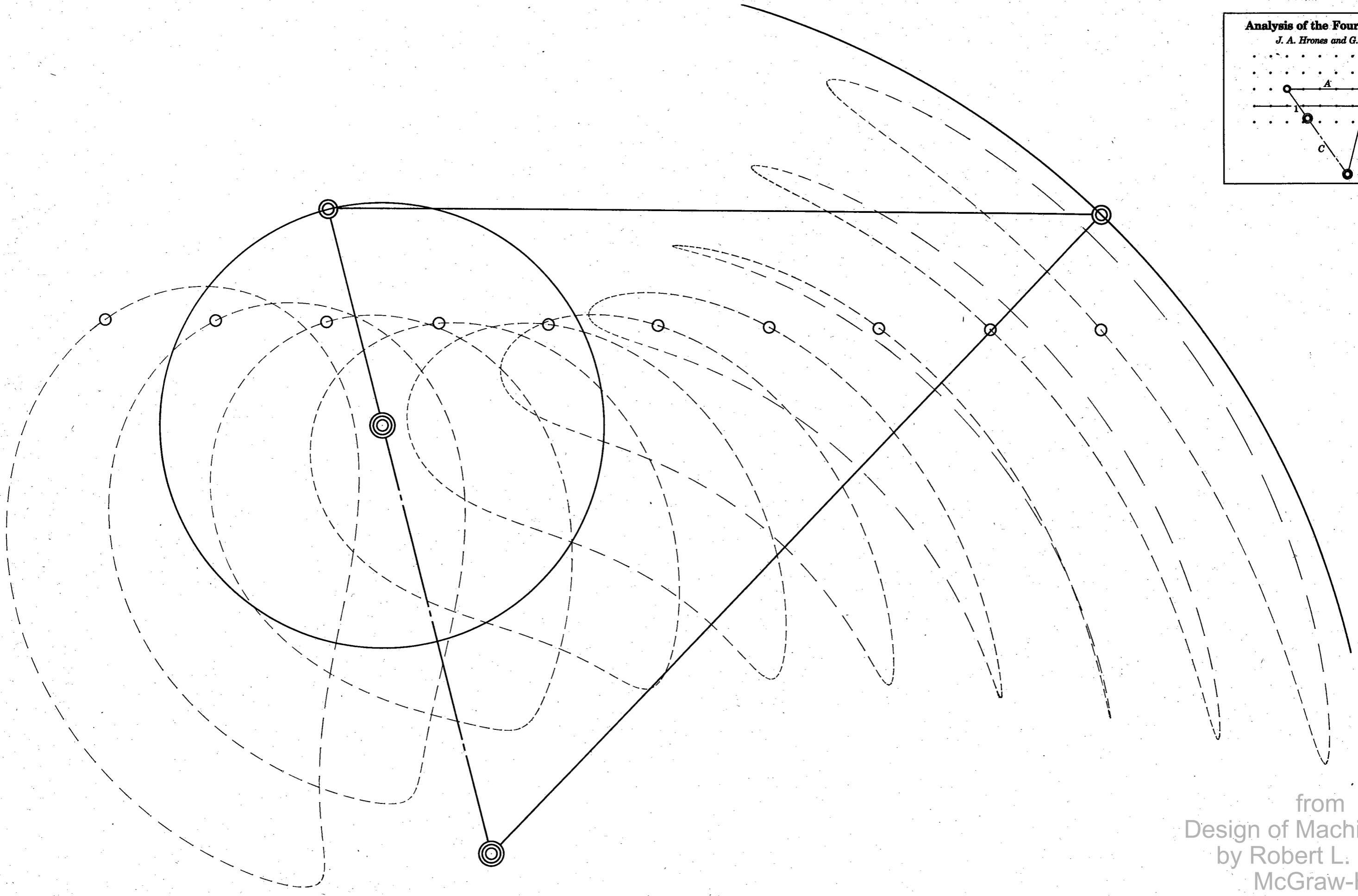

from  
 Design of Machinery 4ed  
 by Robert L. Norton  
 McGraw-Hill  
 Copyright 2008

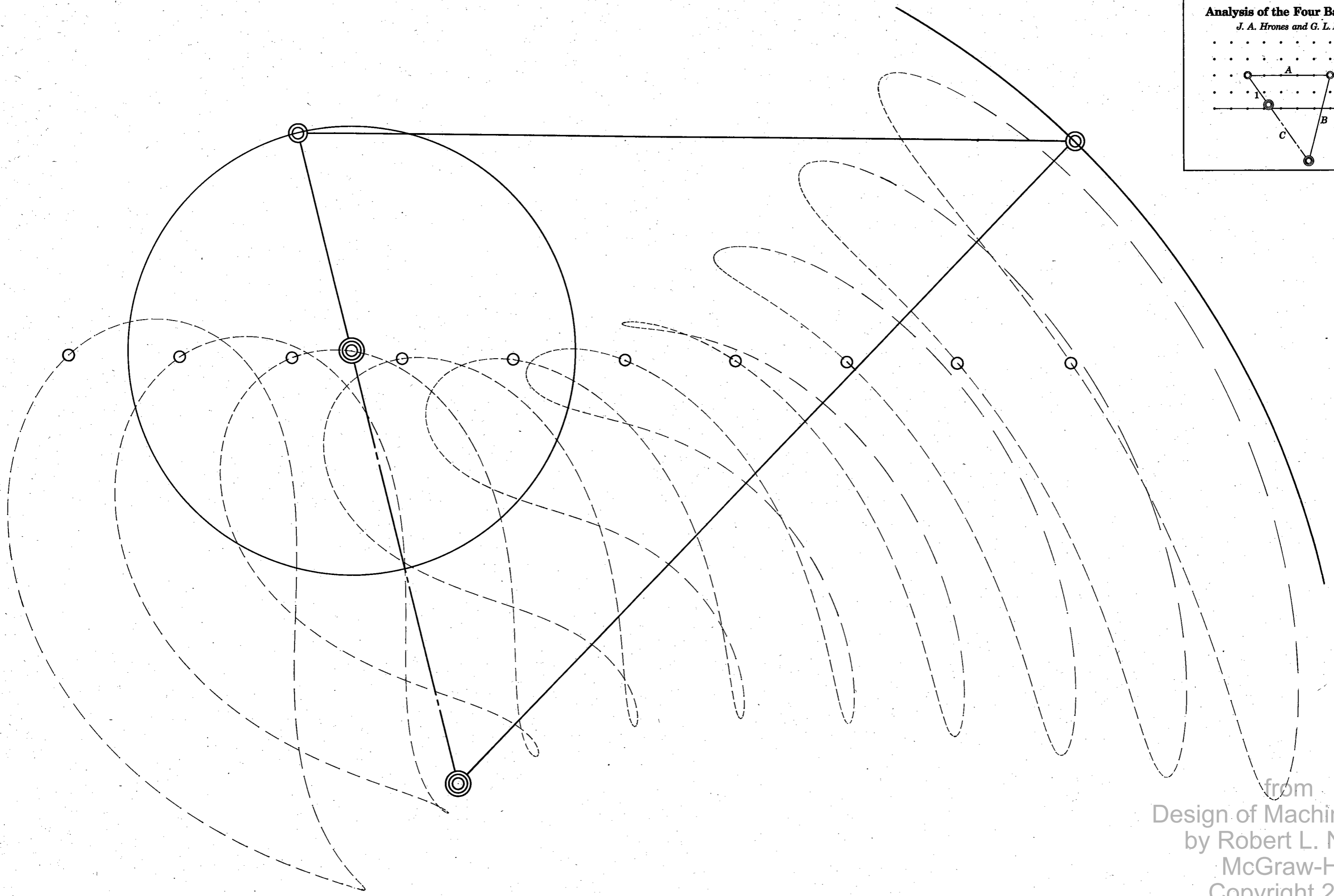
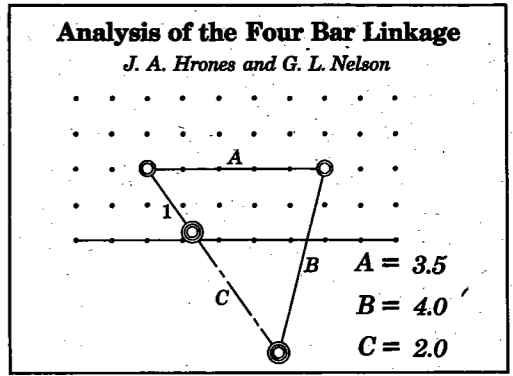

from  
Design of Machinery 4ed  
by Robert L. Norton  
McGraw-Hill  
Copyright 2008

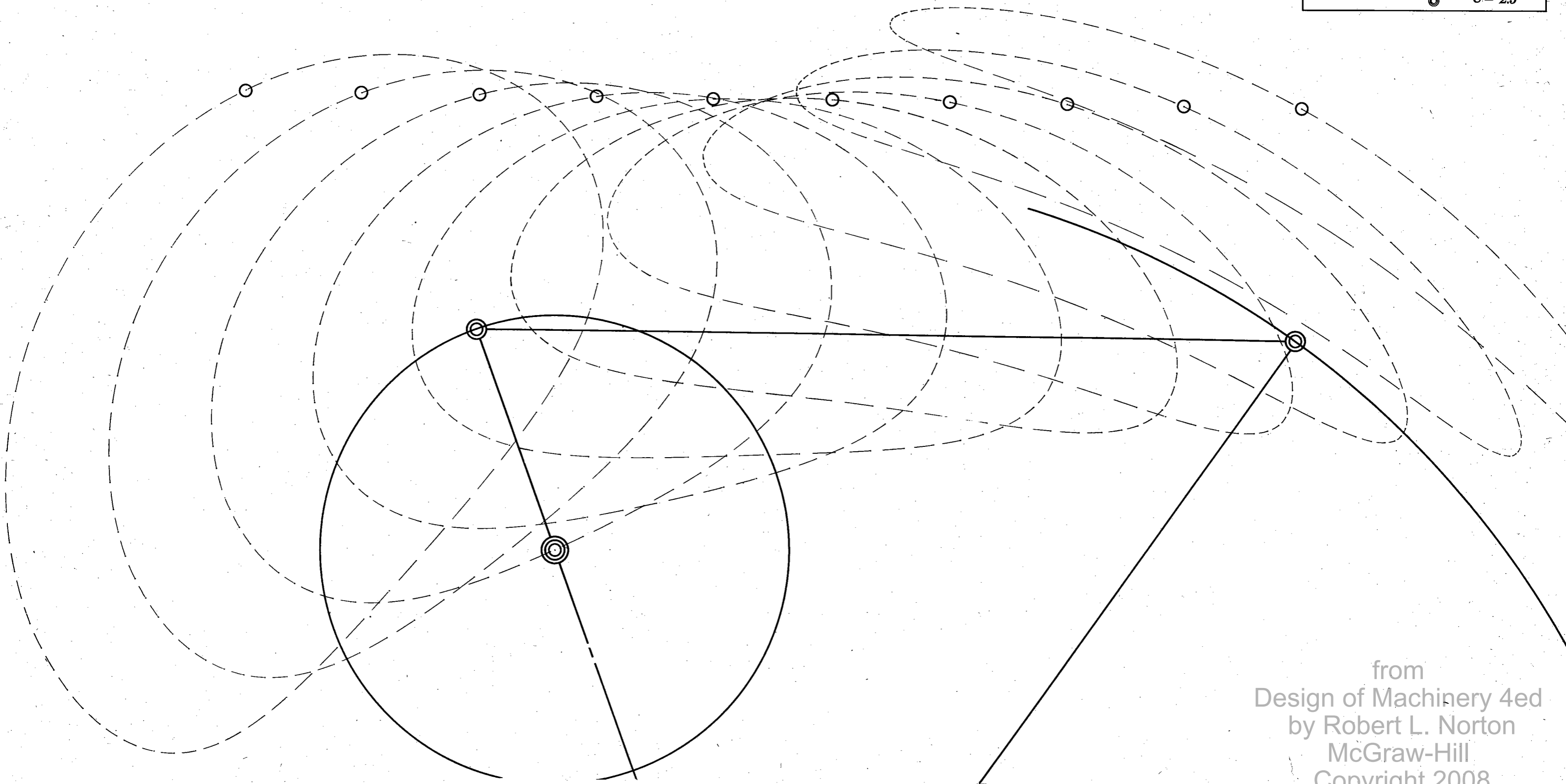
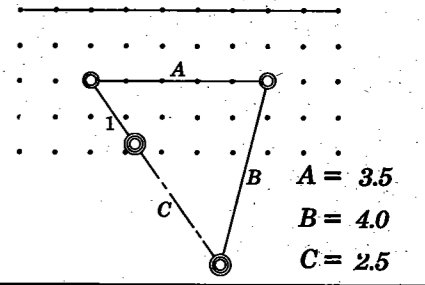

from  
Design of Machinery 4ed  
by Robert L. Norton  
McGraw-Hill  
Copyright 2008

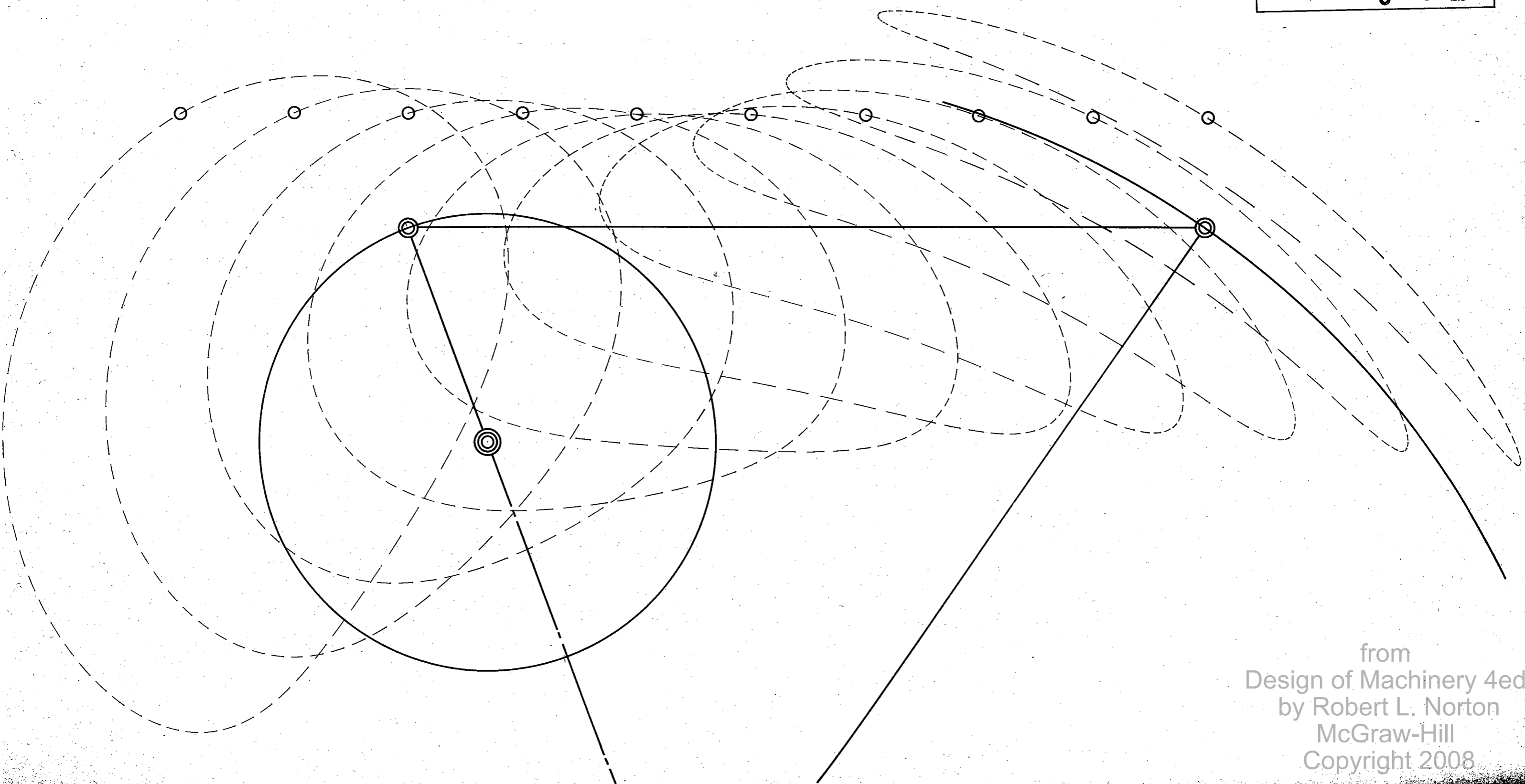
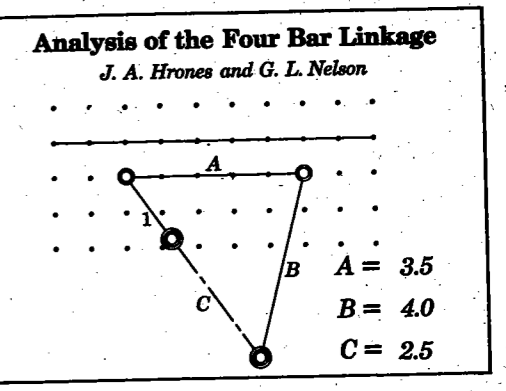

from  
Design of Machinery 4ed  
by Robert L. Norton  
McGraw-Hill  
Copyright 2008

**Analysis of the Four Bar Linkage**

*J. A. Hrones and G. L. Nelson*

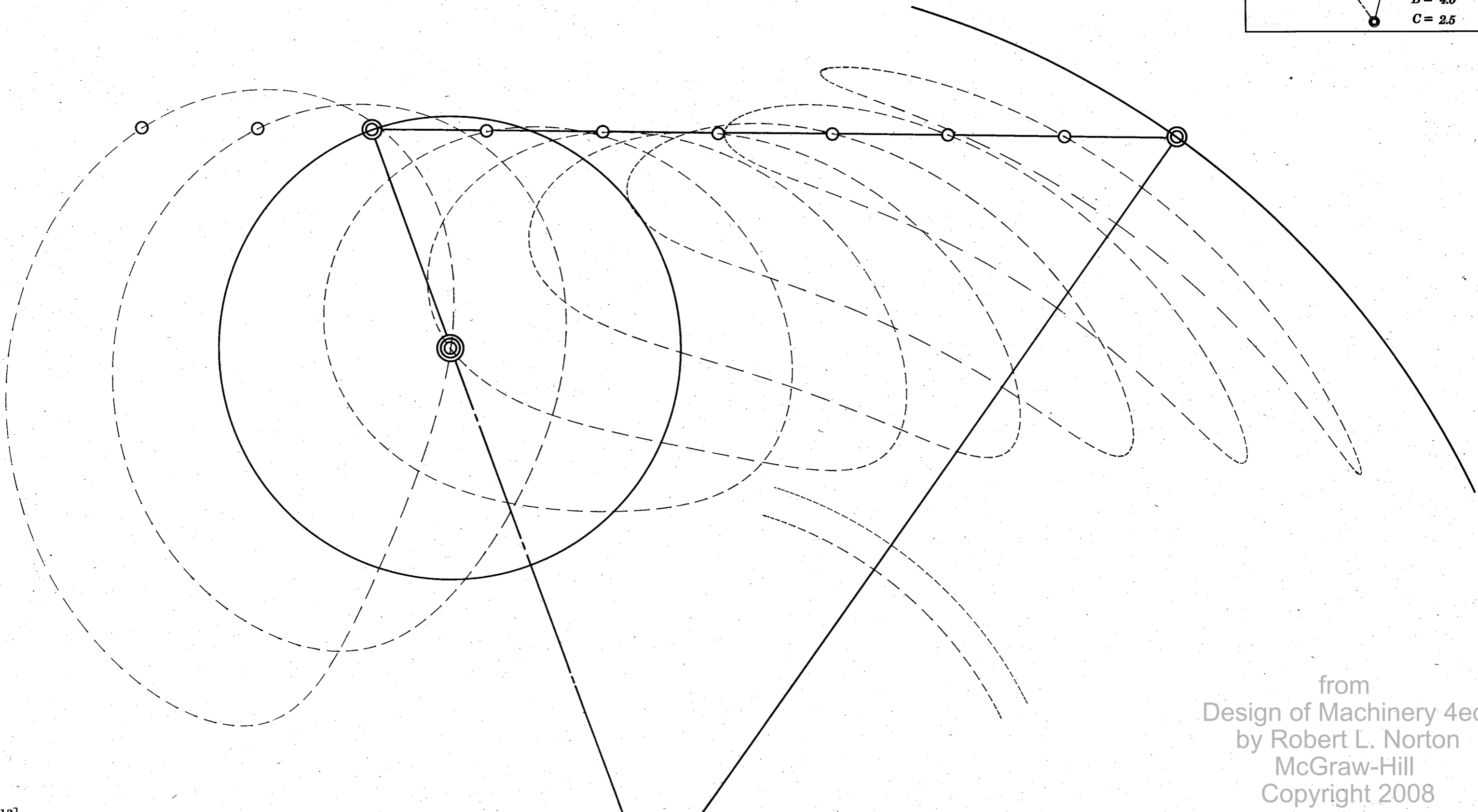
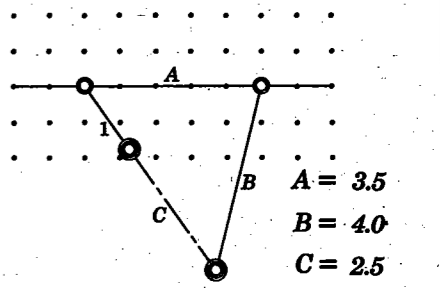

from  
Design of Machinery 4ed  
by Robert L. Norton  
McGraw-Hill  
Copyright 2008

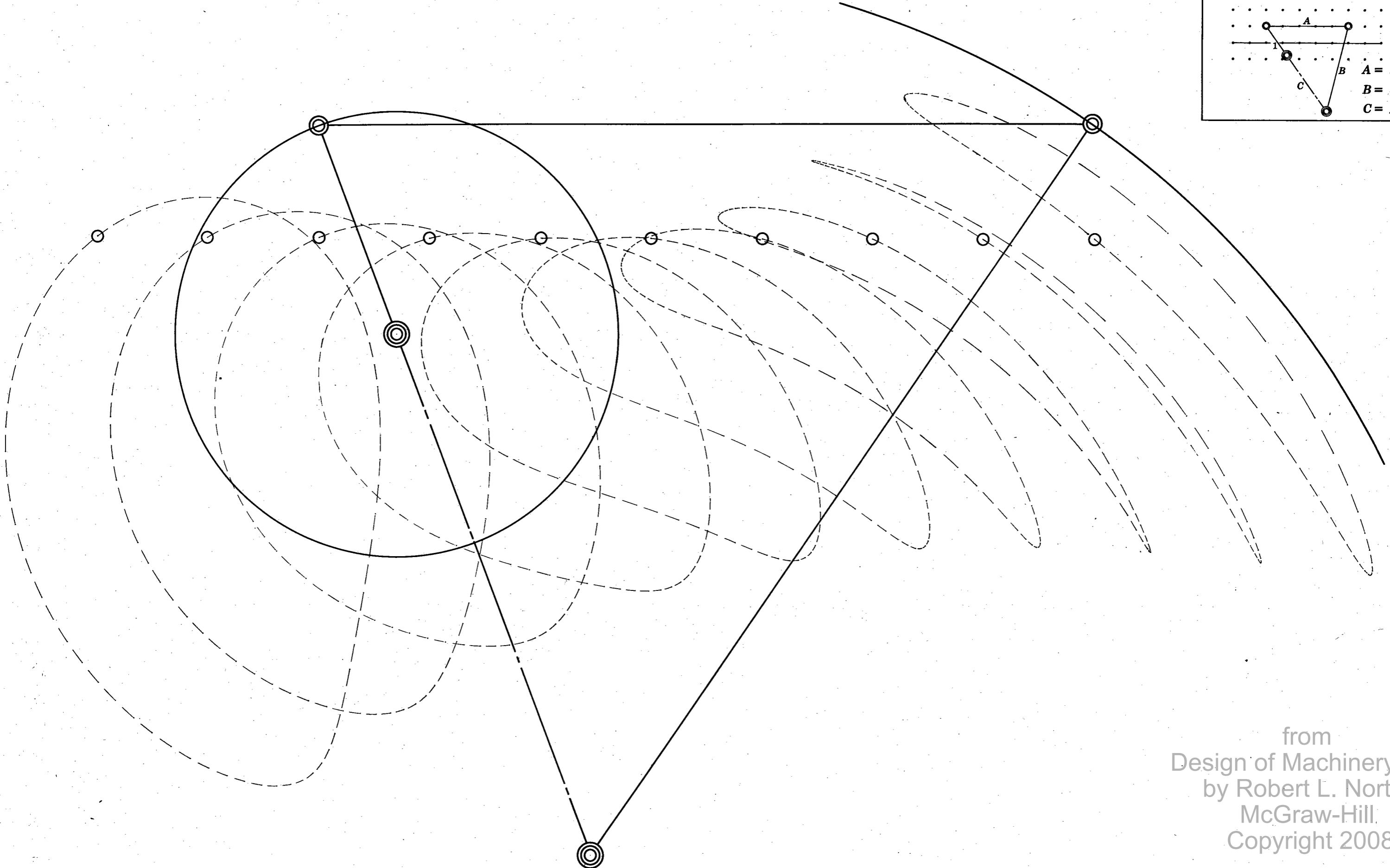
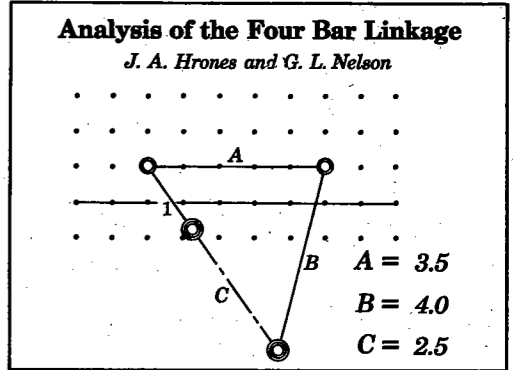

from  
Design of Machinery 4ed  
by Robert L. Norton  
McGraw-Hill  
Copyright 2008

**Analysis of the Four Bar Linkage**

*J. A. Hrones and G. L. Nelson*

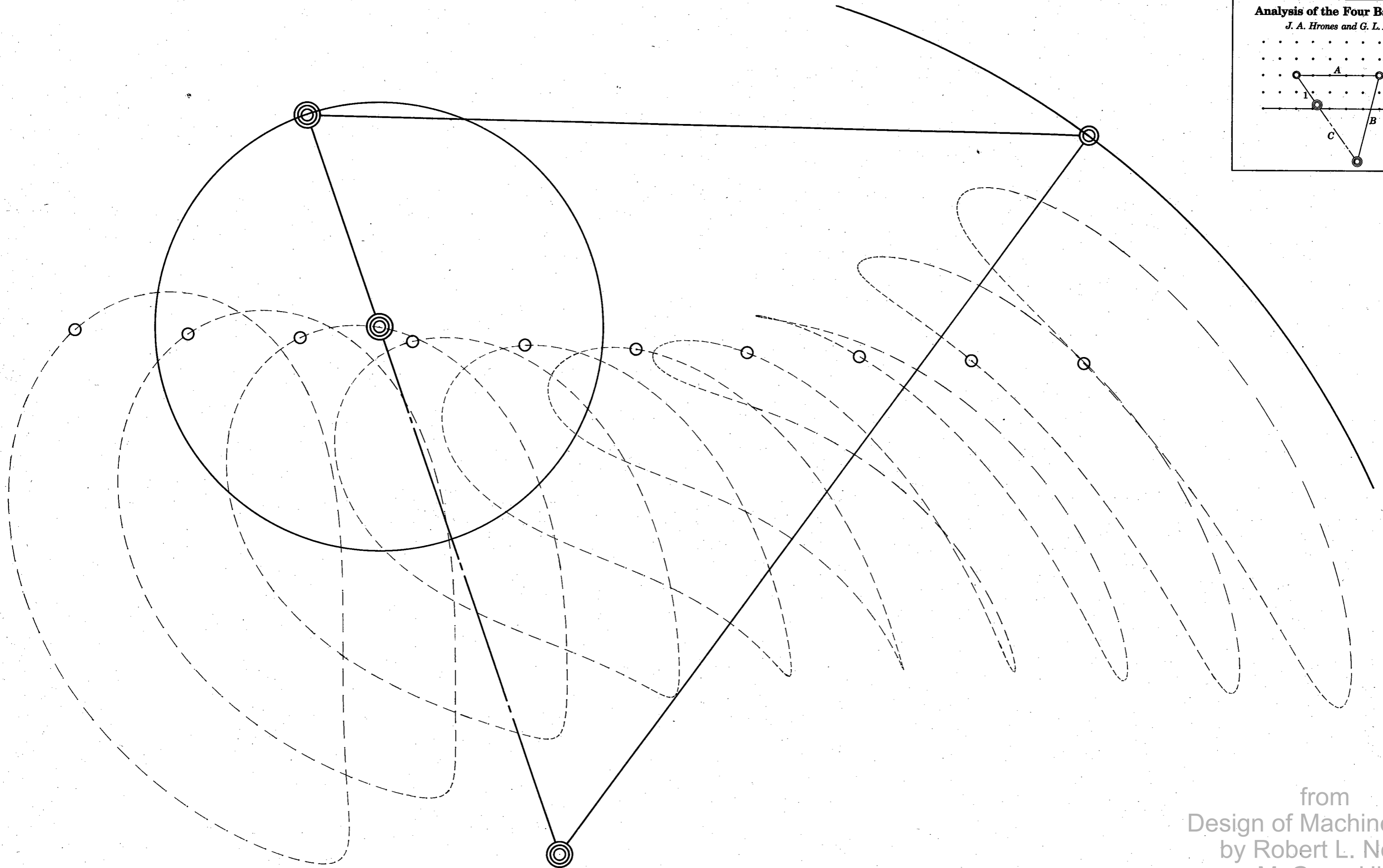
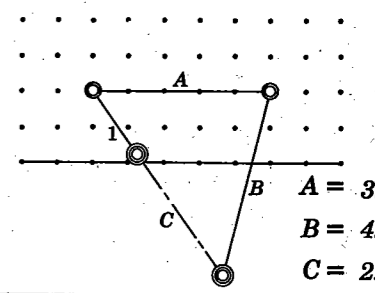

from  
Design of Machinery 4ed  
by Robert L. Norton  
McGraw-Hill  
Copyright 2008



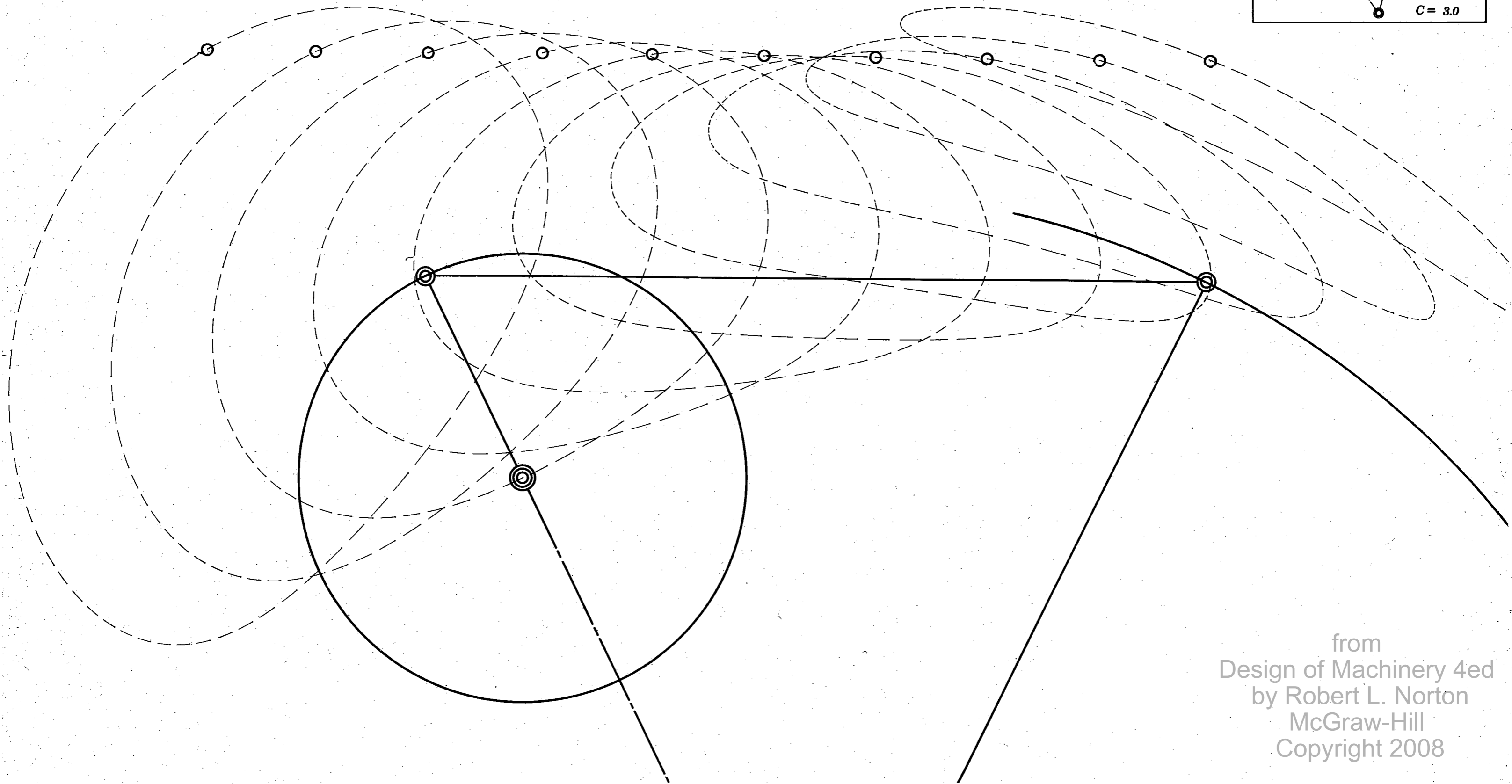
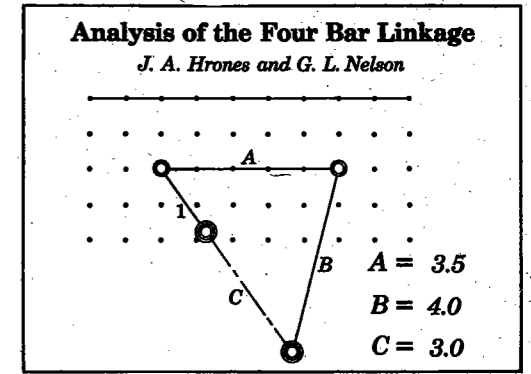

from  
Design of Machinery 4ed  
by Robert L. Norton  
McGraw-Hill  
Copyright 2008

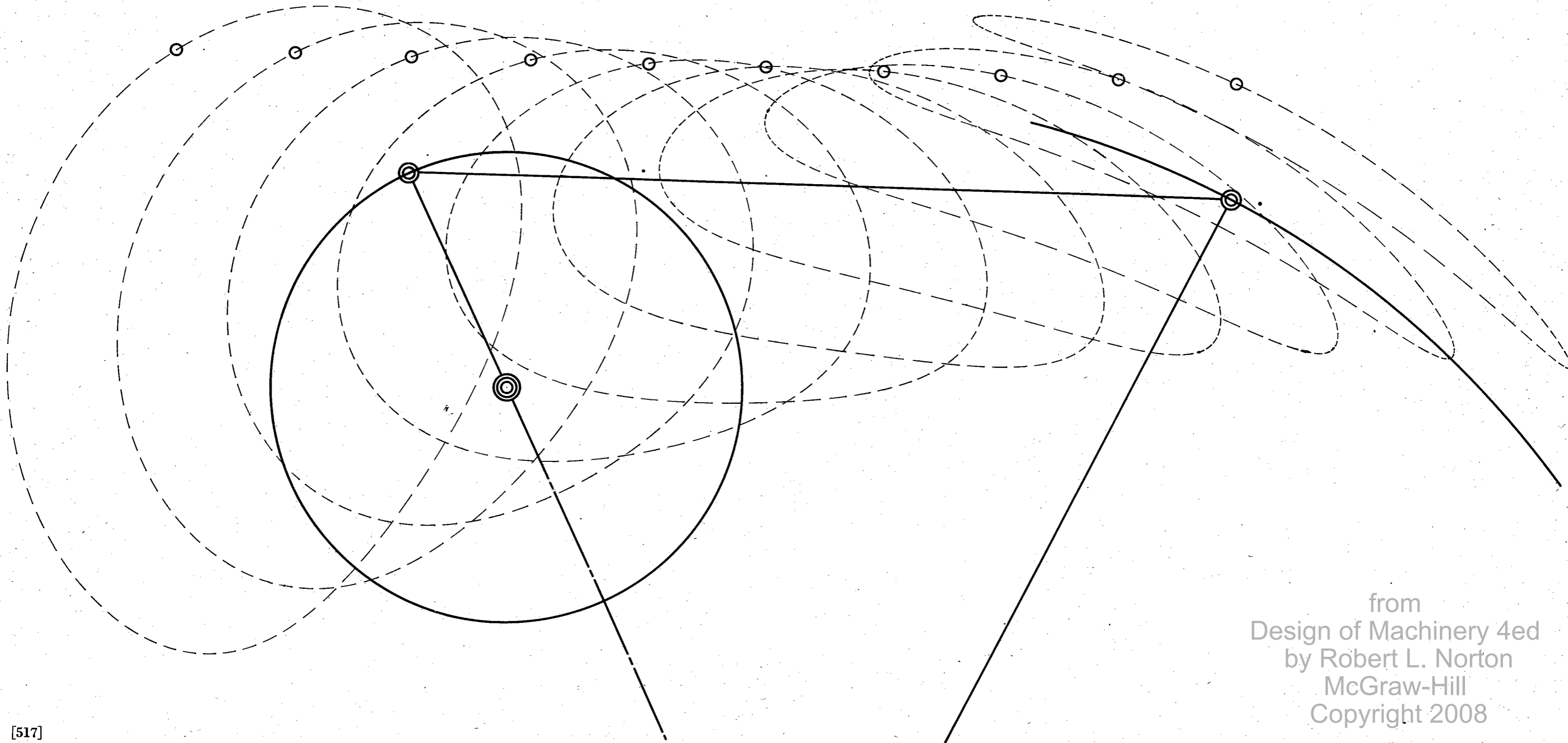
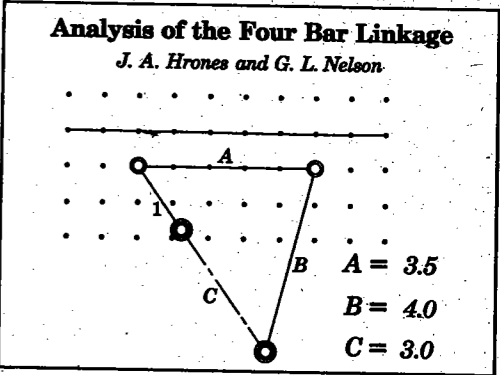

from  
 Design of Machinery 4ed  
 by Robert L. Norton  
 McGraw-Hill  
 Copyright 2008

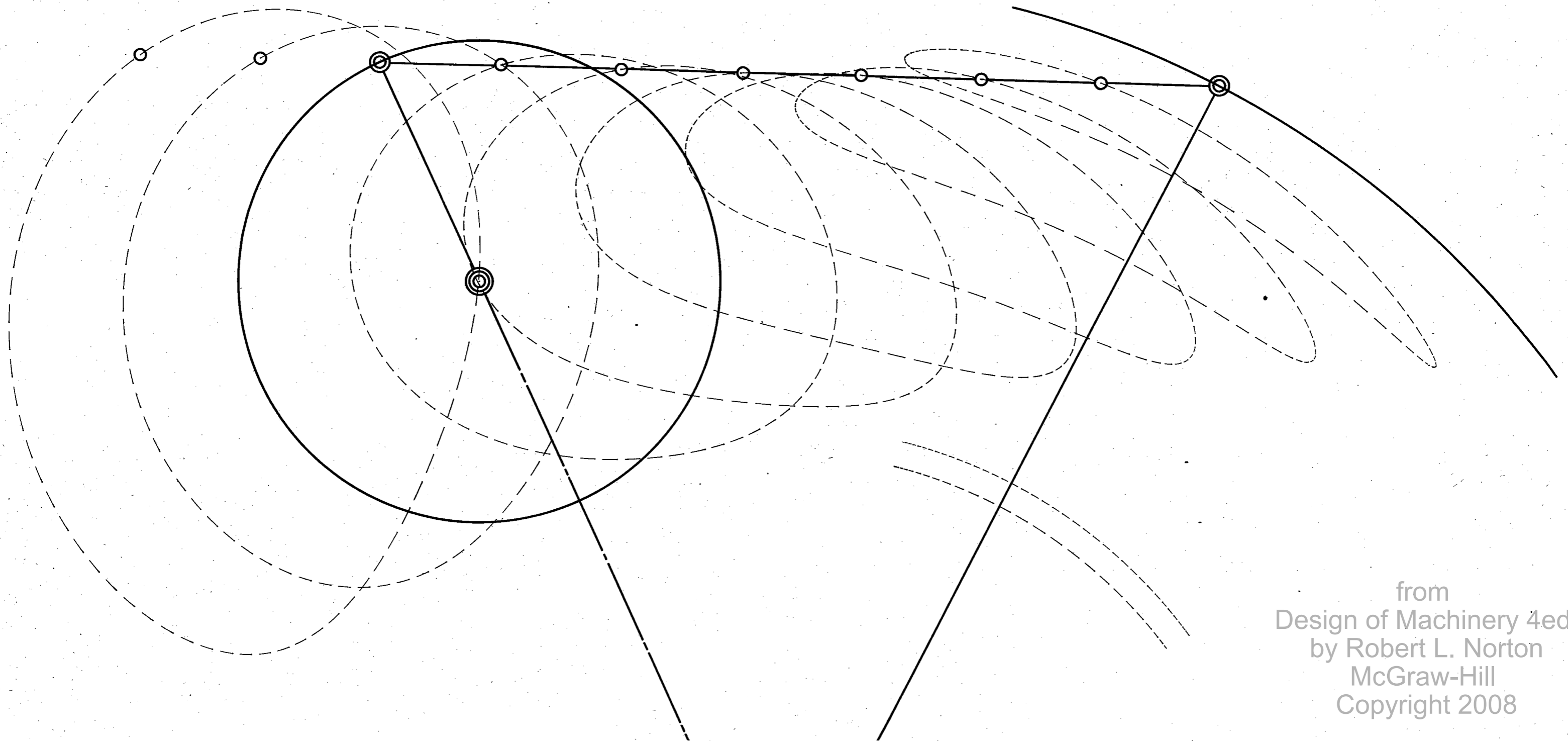
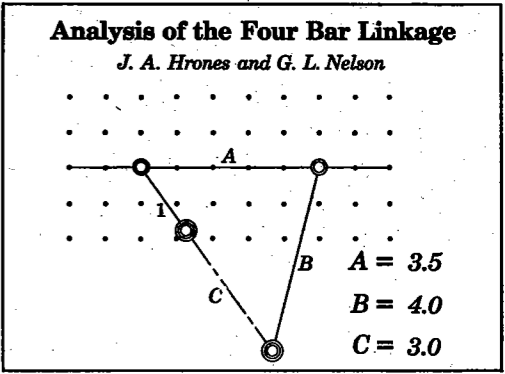

from  
Design of Machinery 4ed  
by Robert L. Norton  
McGraw-Hill  
Copyright 2008

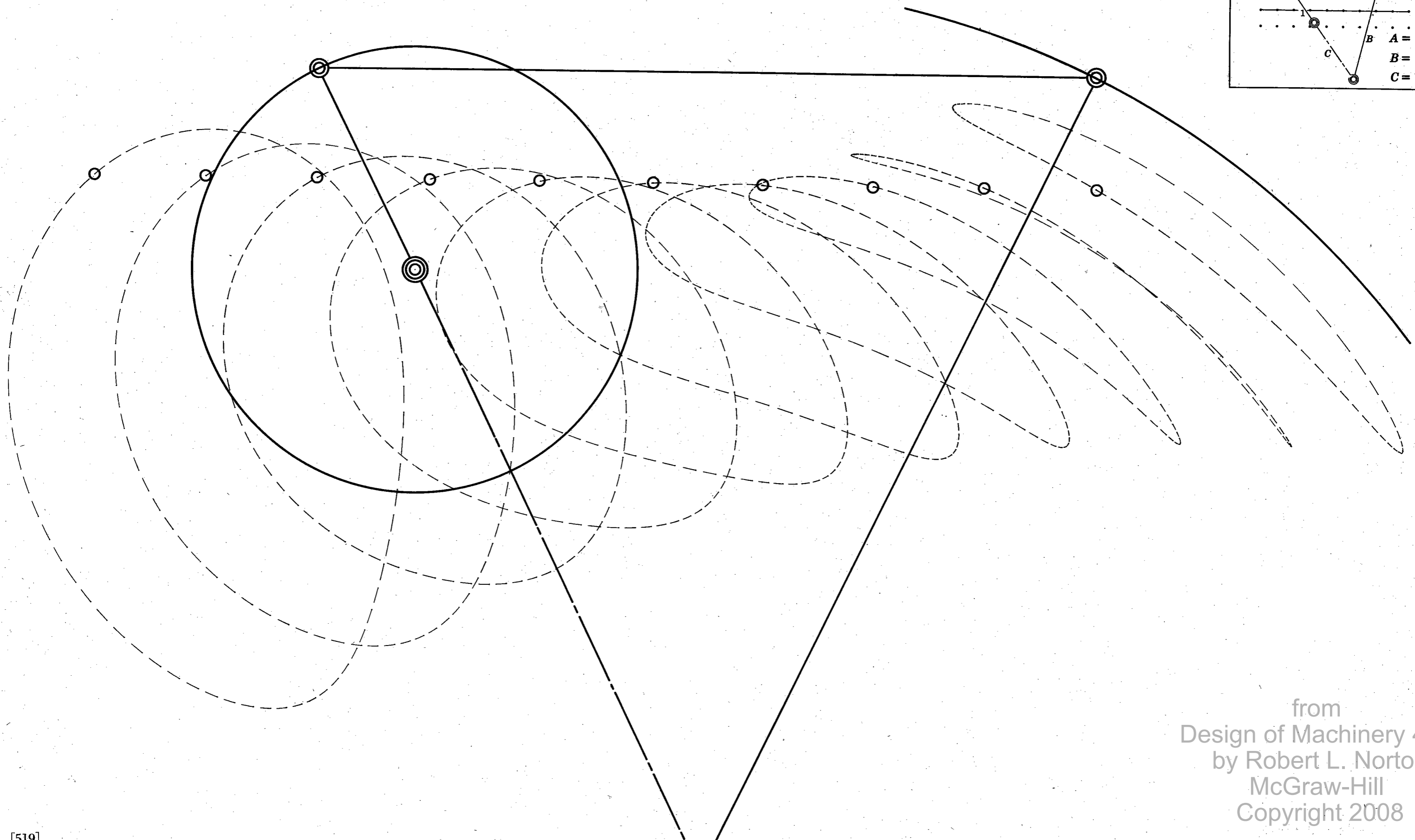
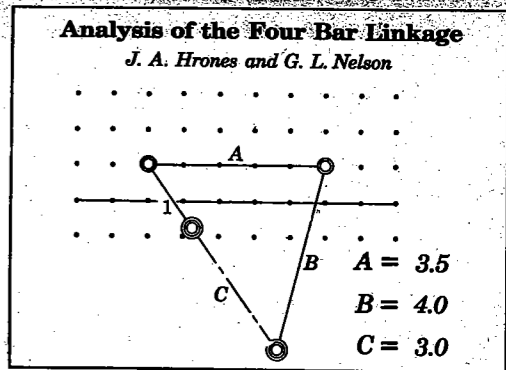

from  
 Design of Machinery 4ed  
 by Robert L. Norton  
 McGraw-Hill  
 Copyright 2008

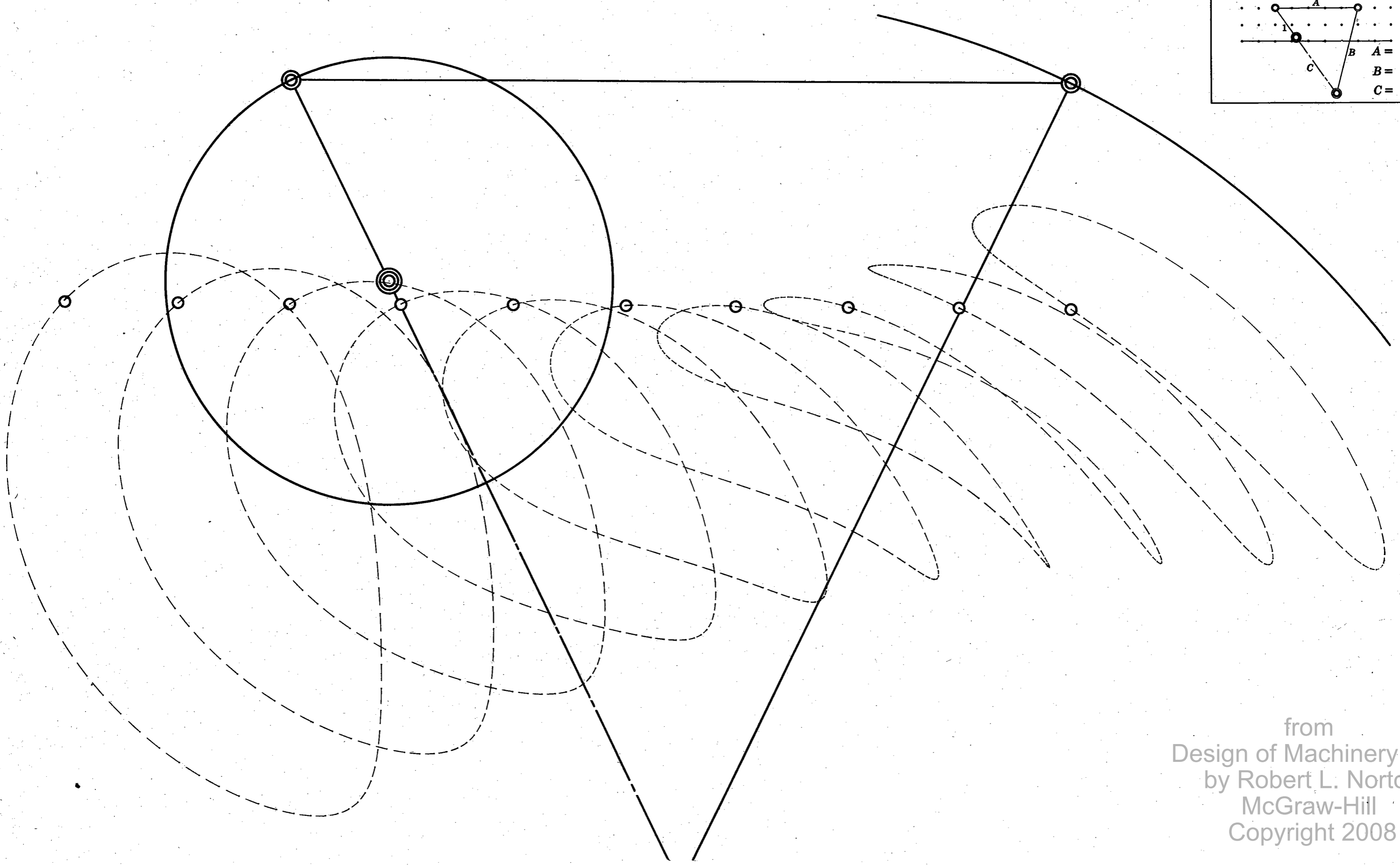
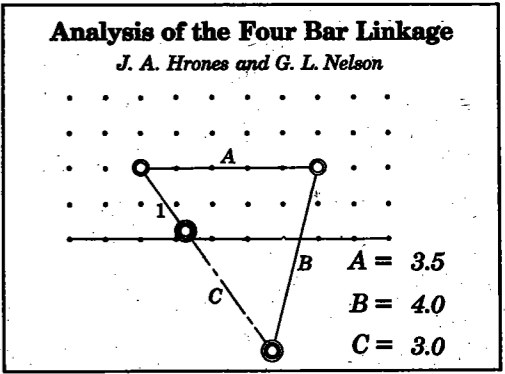

from  
Design of Machinery 4ed  
by Robert L. Norton  
McGraw-Hill  
Copyright 2008

**Analysis of the Four Bar Linkage**  
*J. A. Hrones and G. L. Nelson*

$A = 3.5$   
 $B = 4.0$   
 $C = 3.5$

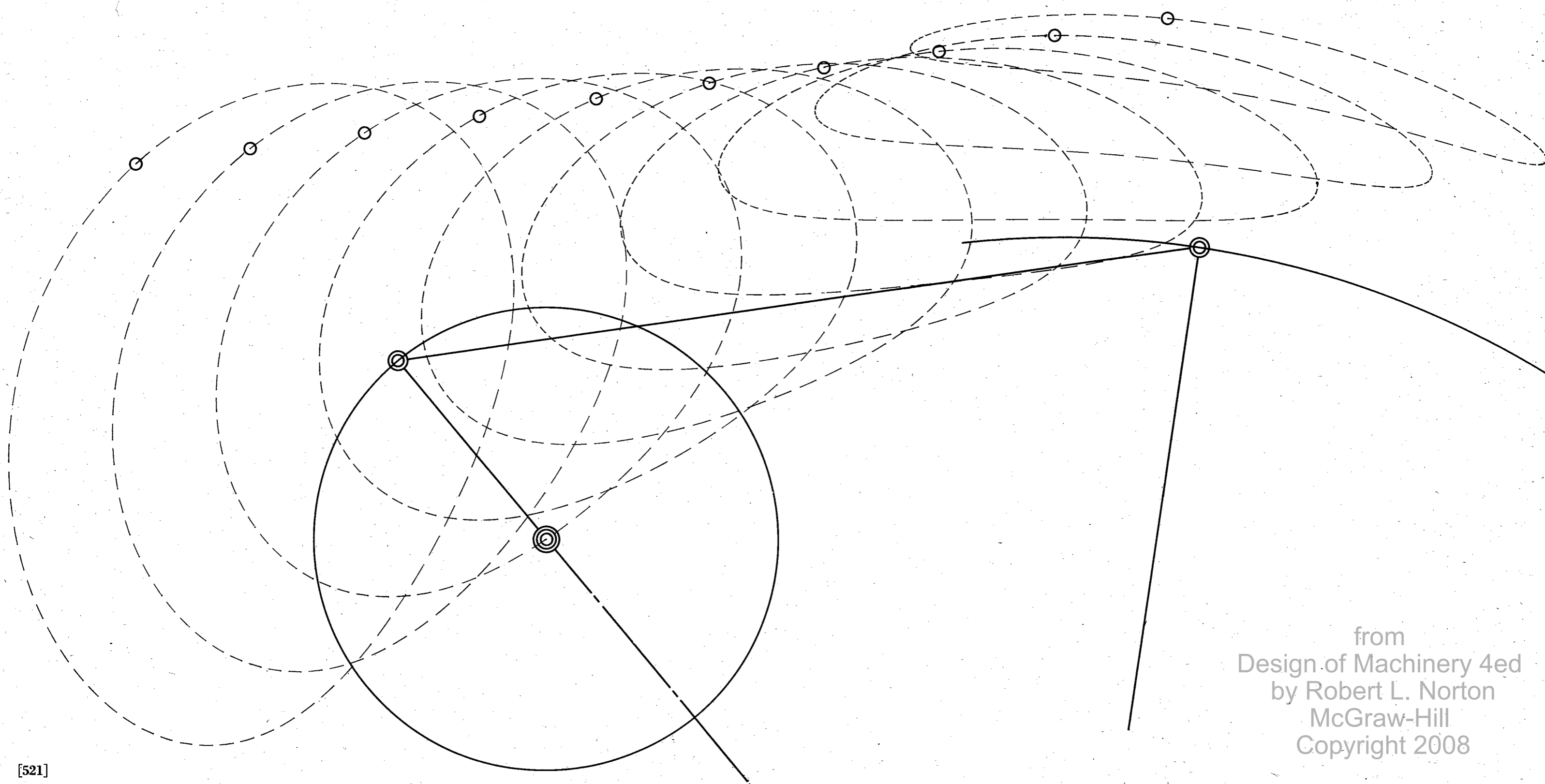

from  
 Design of Machinery 4ed  
 by Robert L. Norton  
 McGraw-Hill  
 Copyright 2008

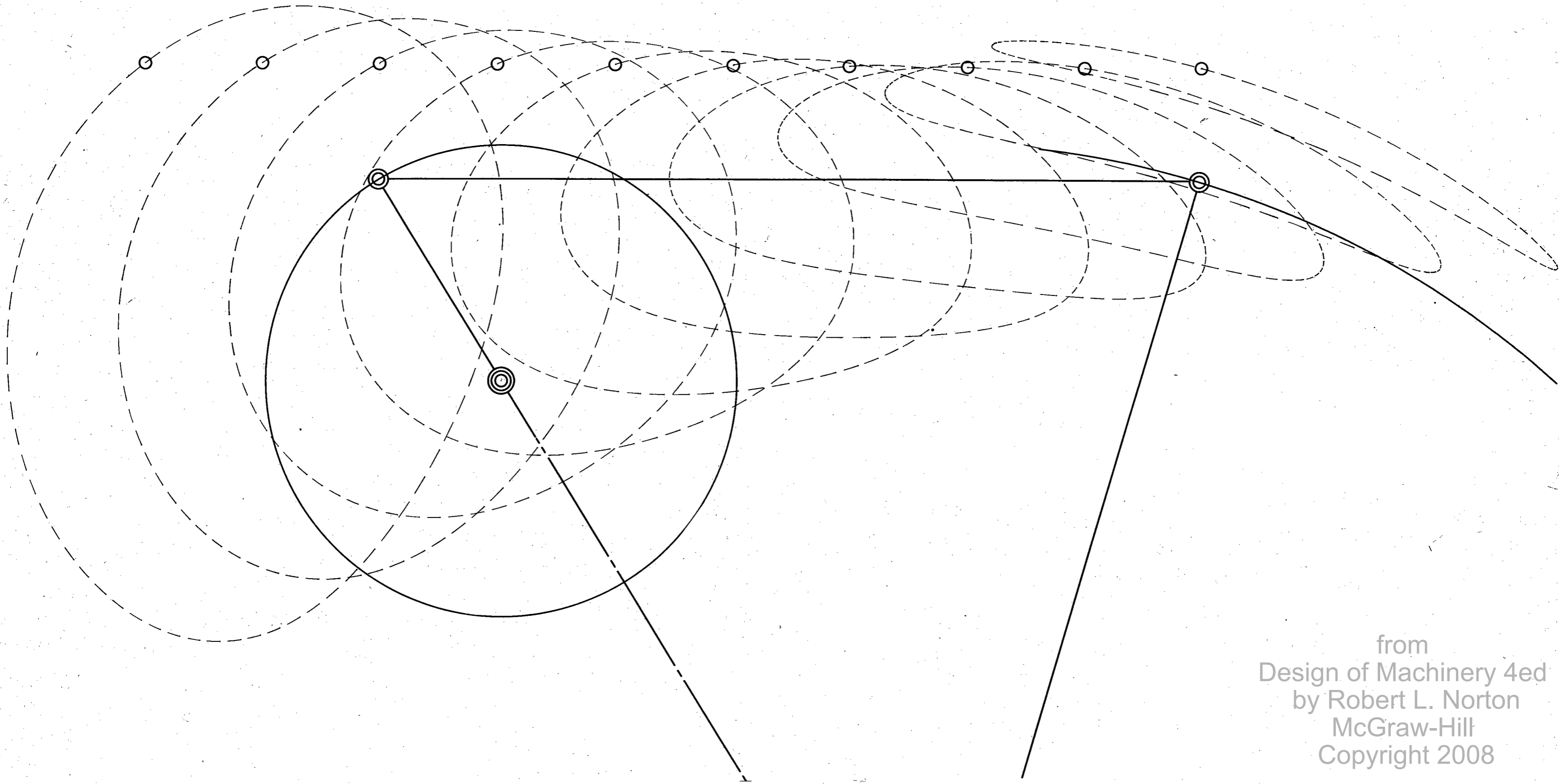
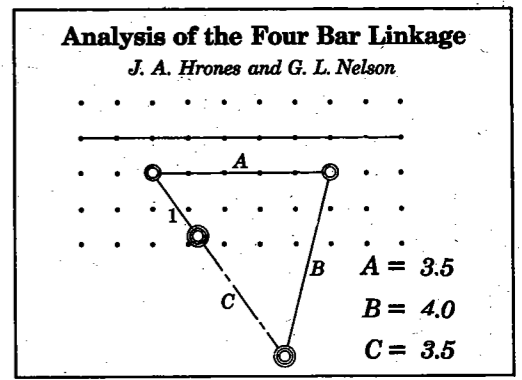

from  
Design of Machinery 4ed  
by Robert L. Norton  
McGraw-Hill  
Copyright 2008

**Analysis of the Four Bar Linkage**

*J. A. Hrones and G. L. Nelson*

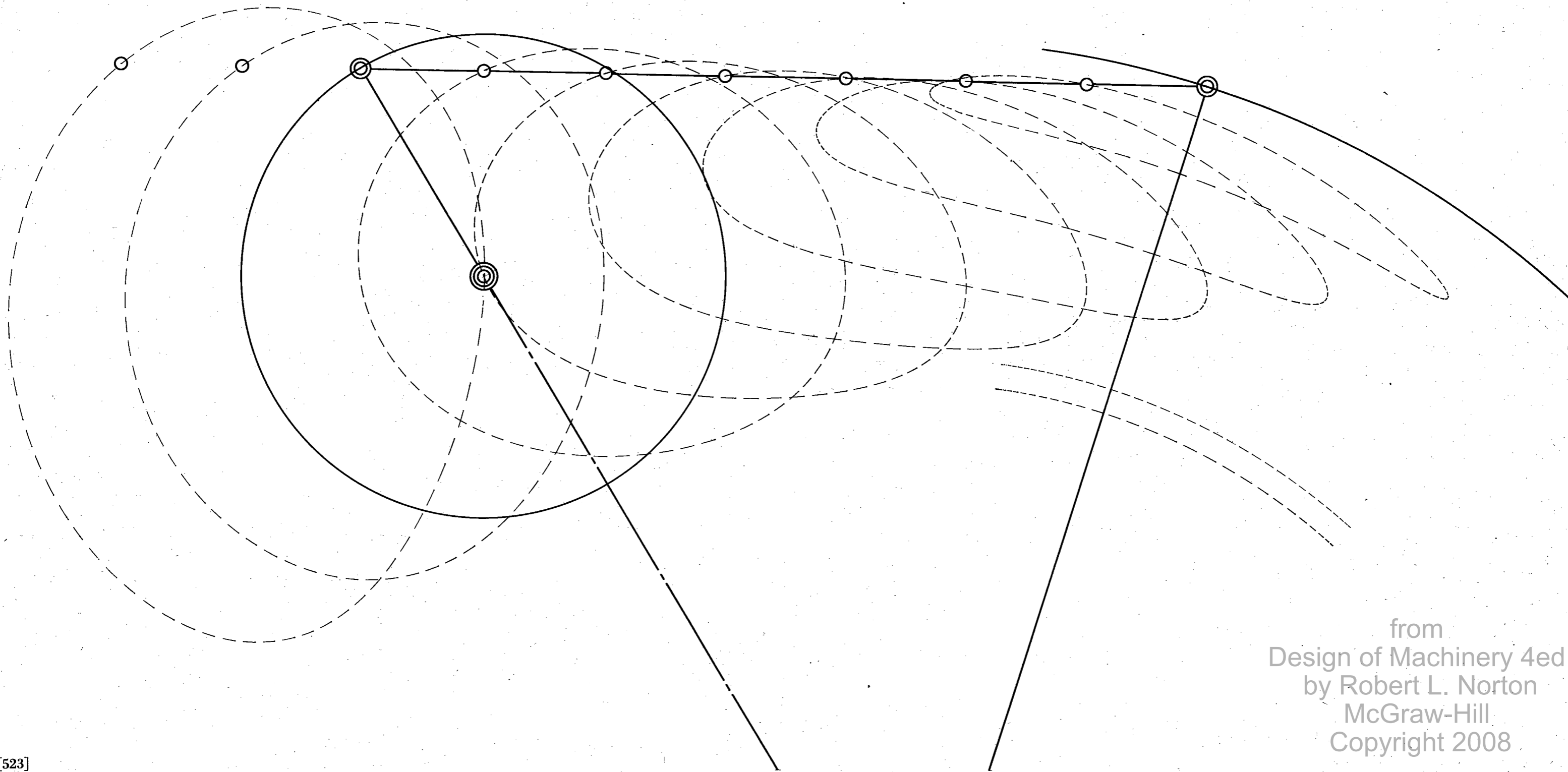
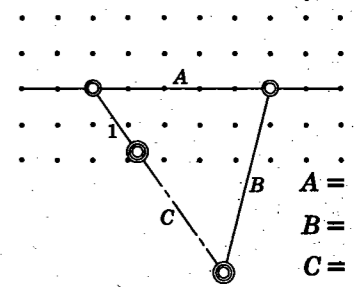

from  
Design of Machinery 4ed  
by Robert L. Norton  
McGraw-Hill  
Copyright 2008



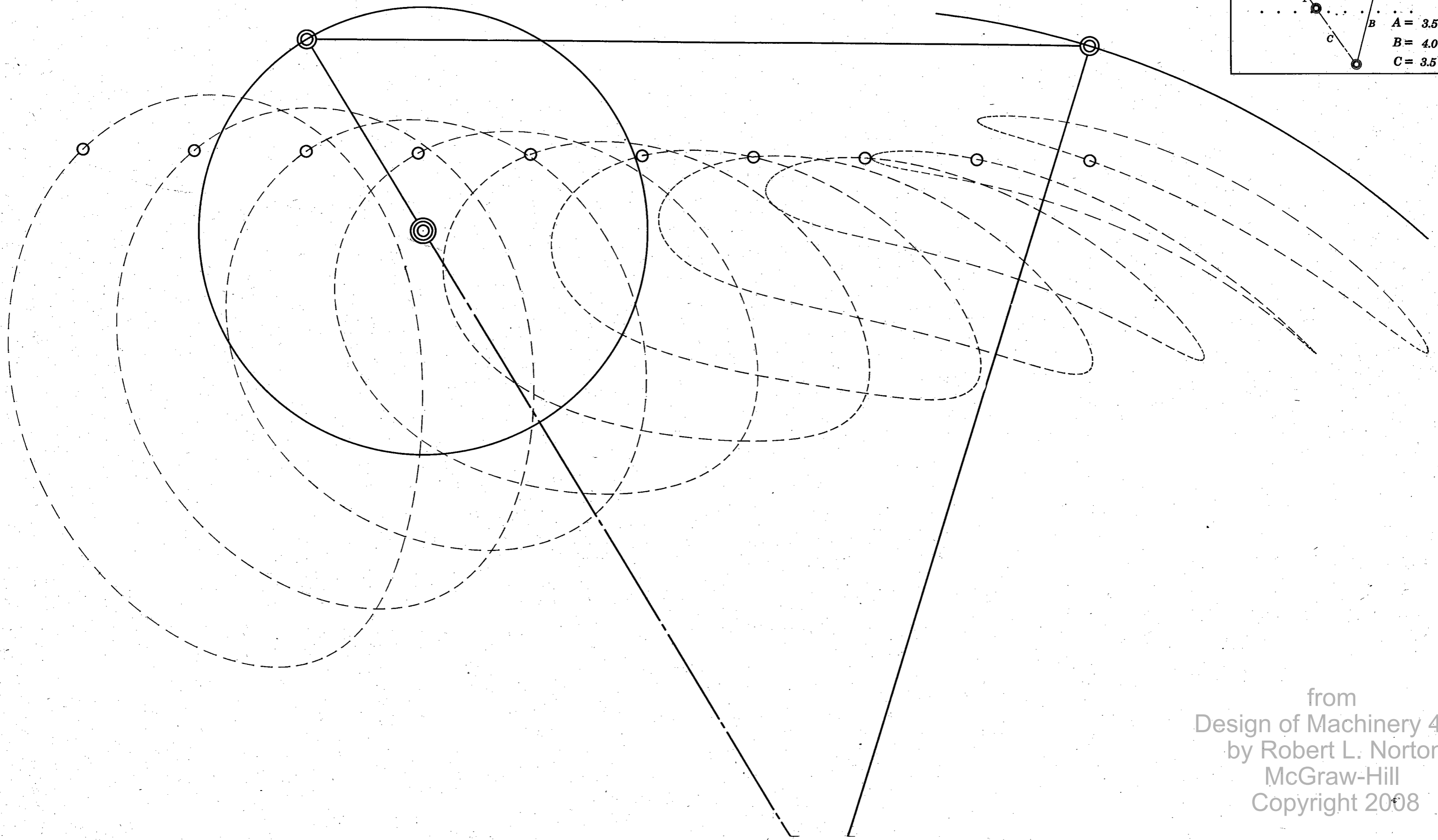
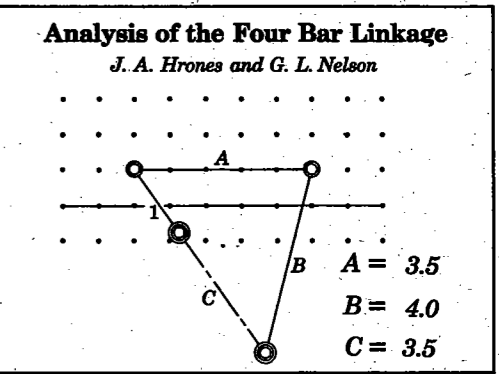

from  
Design of Machinery 4ed  
by Robert L. Norton  
McGraw-Hill  
Copyright 2008

**Analysis of the Four Bar Linkage**  
*J. A. Hrones and G. L. Nelson*

$A = 3.5$   
 $B = 4.0$   
 $C = 3.5$

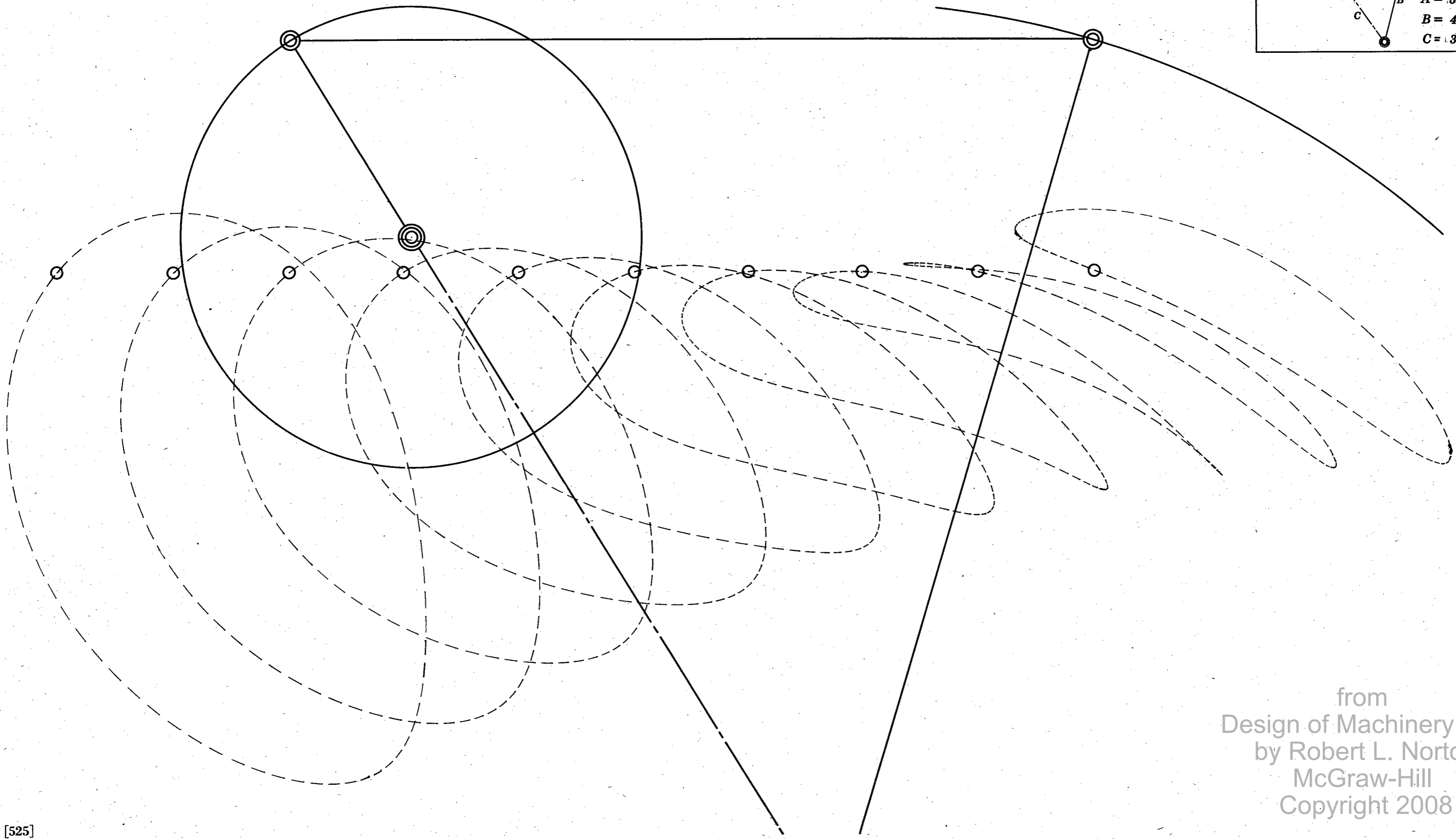

from  
 Design of Machinery 4ed  
 by Robert L. Norton  
 McGraw-Hill  
 Copyright 2008

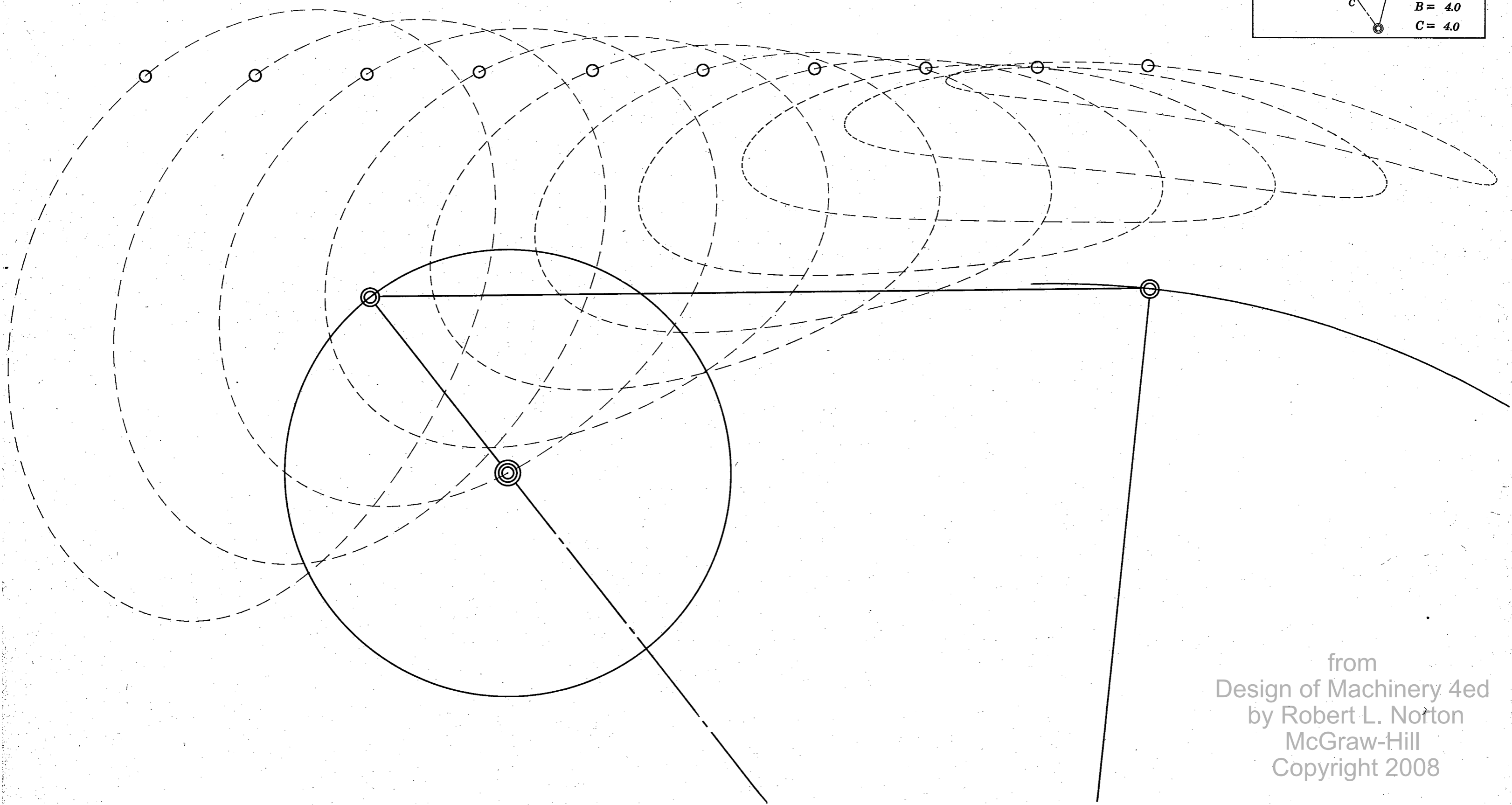
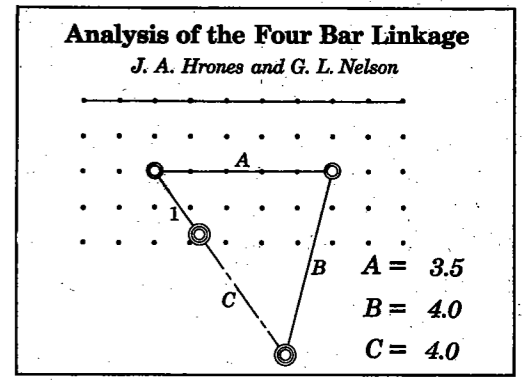

from  
Design of Machinery 4ed  
by Robert L. Norton  
McGraw-Hill  
Copyright 2008

**Analysis of the Four Bar Linkage**

*J. A. Hrones and G. L. Nelson*

.....

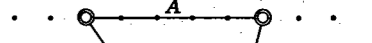
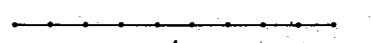

.....

.....

.....

.....

$A = 3.5$   
 $B = 4.0$   
 $C = 4.0$

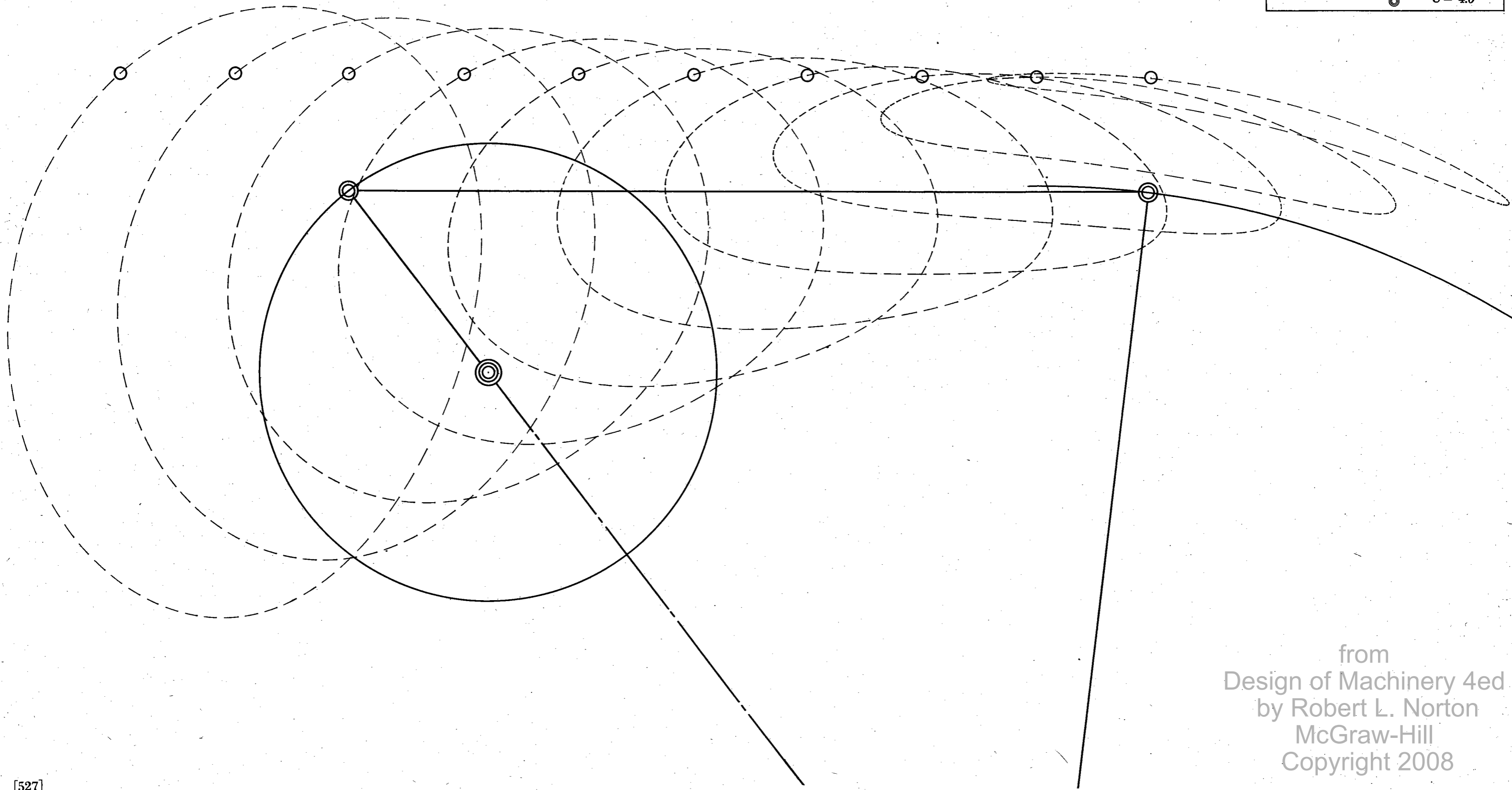

from  
Design of Machinery 4ed  
by Robert L. Norton  
McGraw-Hill  
Copyright 2008

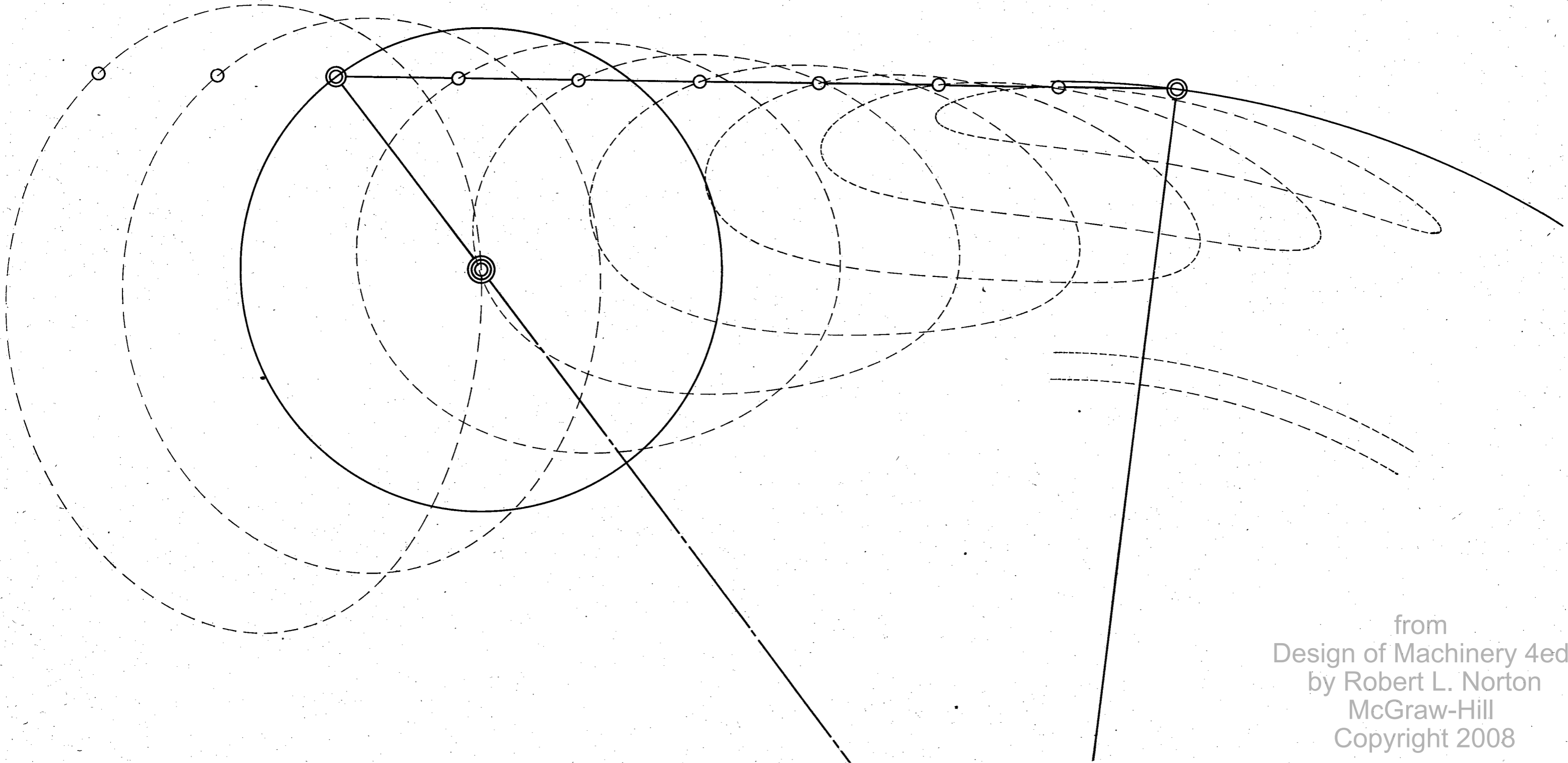
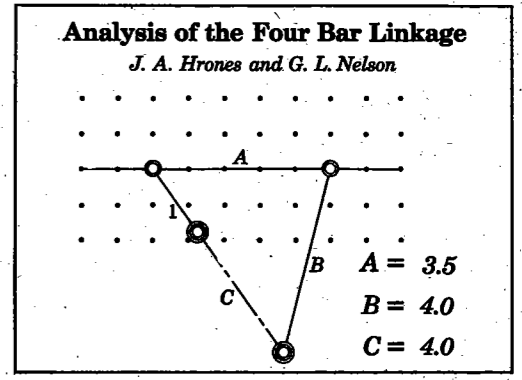

from  
Design of Machinery 4ed  
by Robert L. Norton  
McGraw-Hill  
Copyright 2008

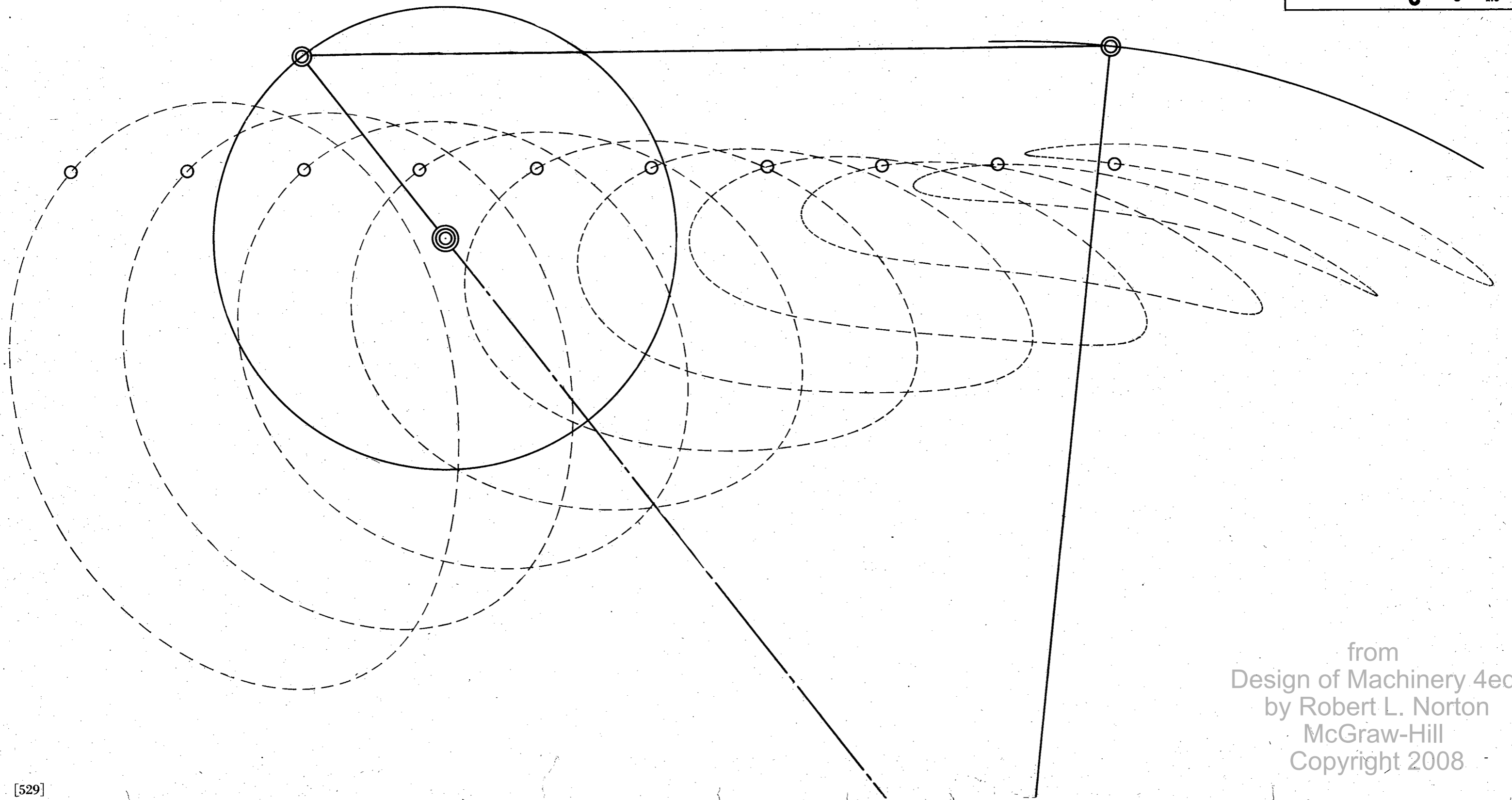
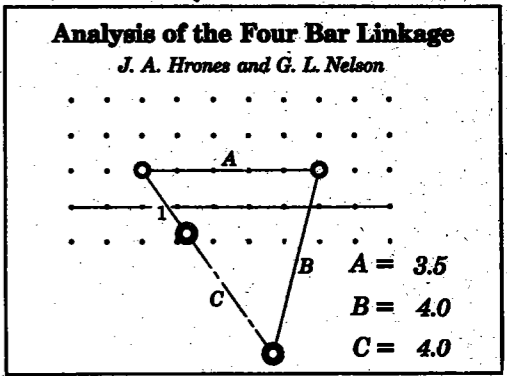

from  
 Design of Machinery 4ed  
 by Robert L. Norton  
 McGraw-Hill  
 Copyright 2008

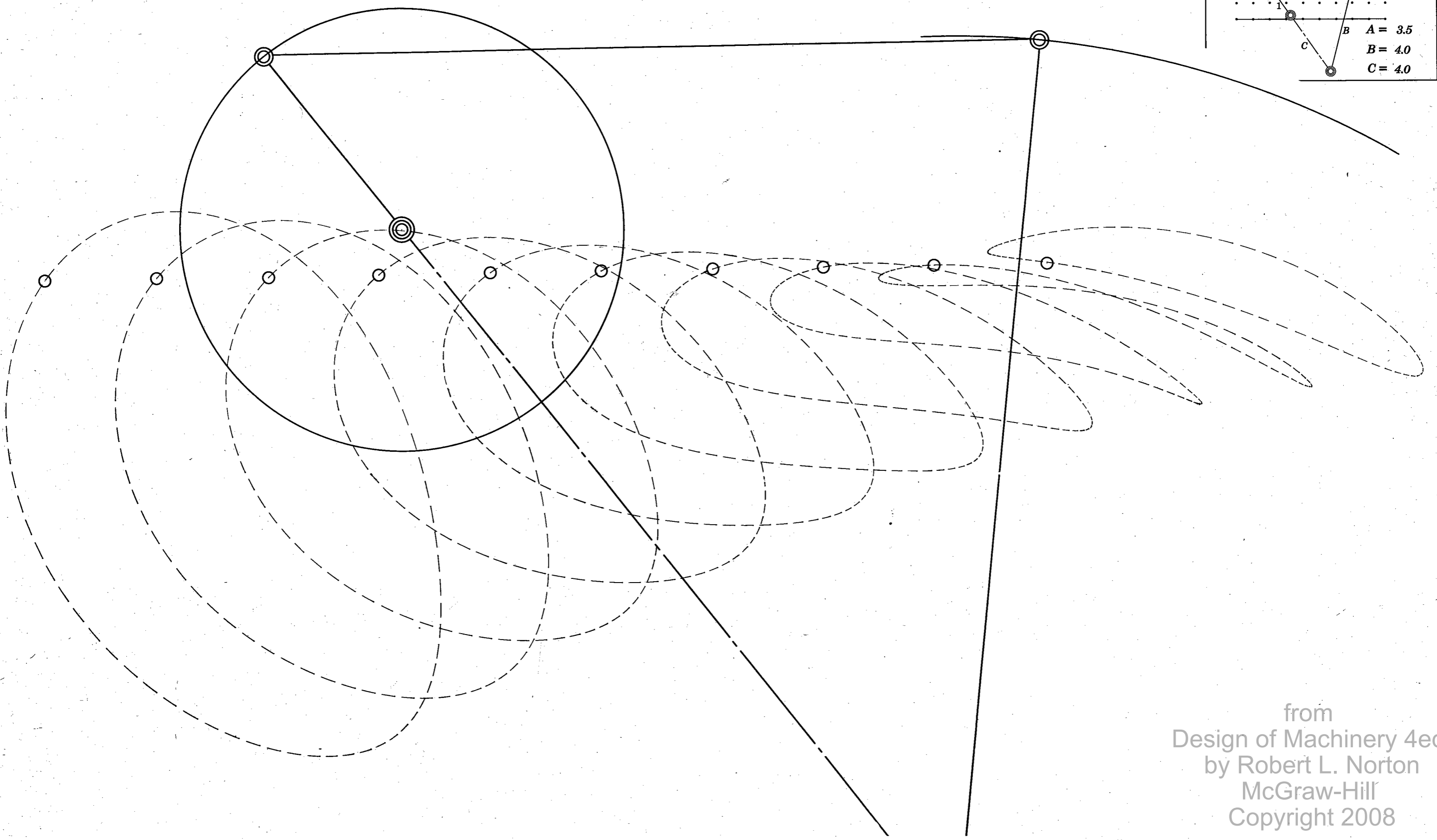
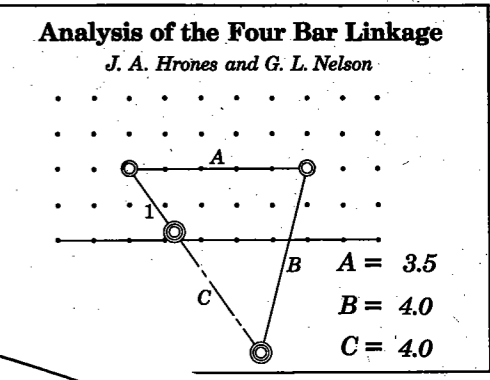

from  
Design of Machinery 4ed  
by Robert L. Norton  
McGraw-Hill  
Copyright 2008

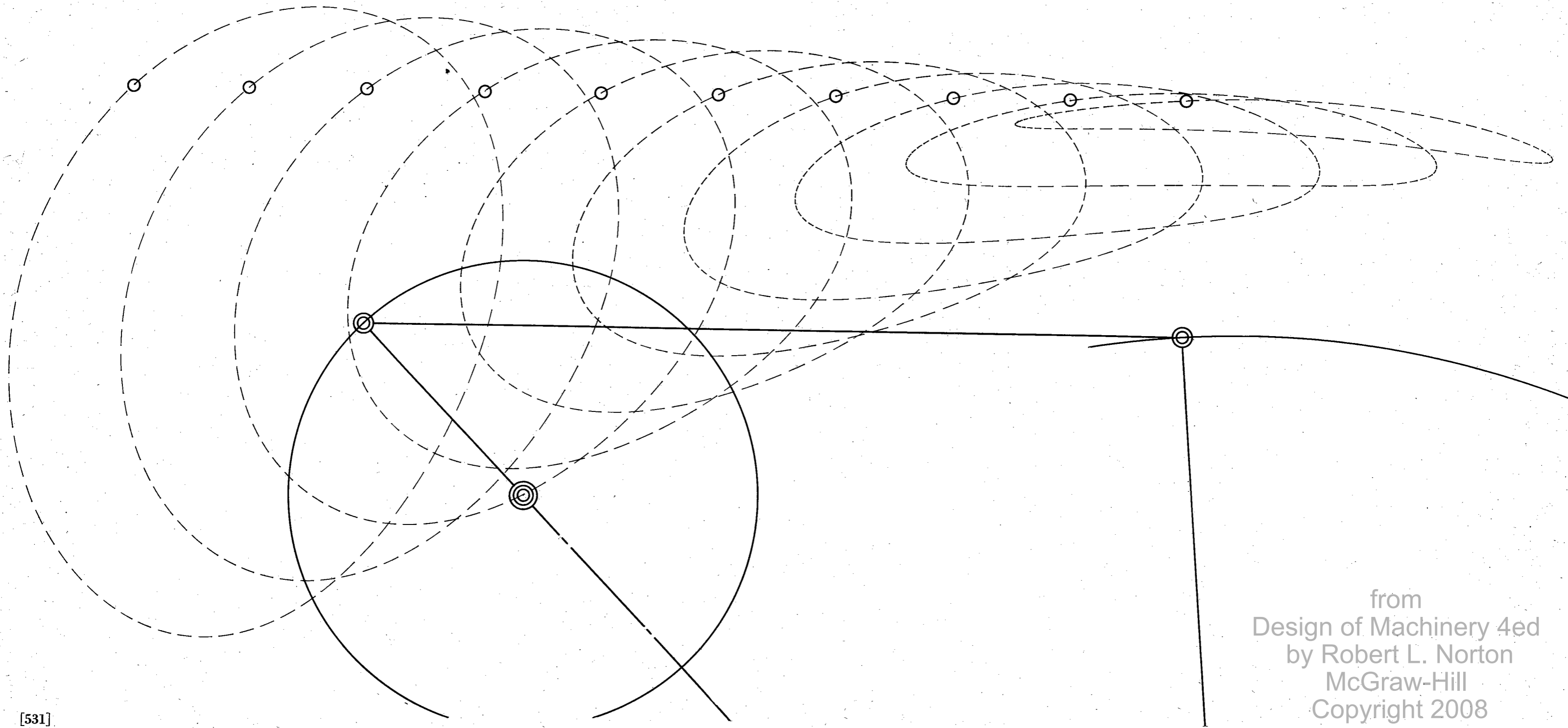
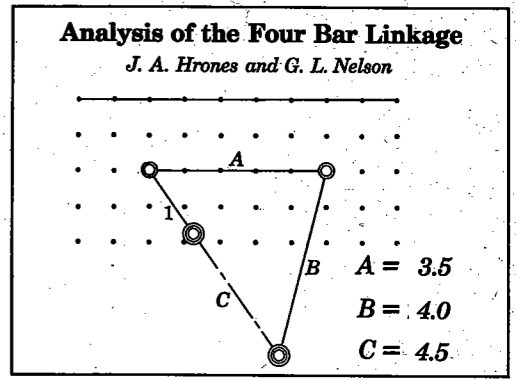

from  
 Design of Machinery 4ed  
 by Robert L. Norton  
 McGraw-Hill  
 Copyright 2008



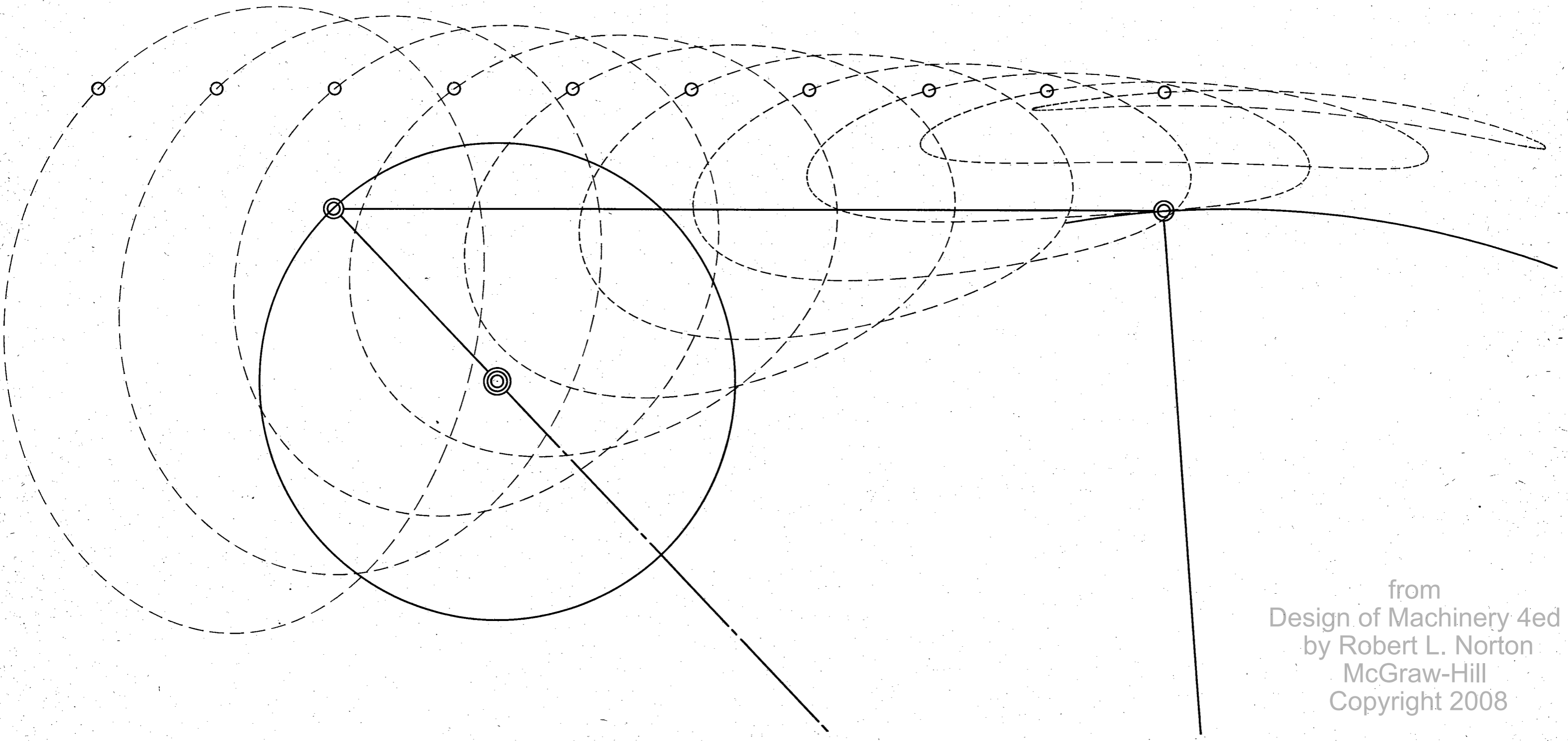
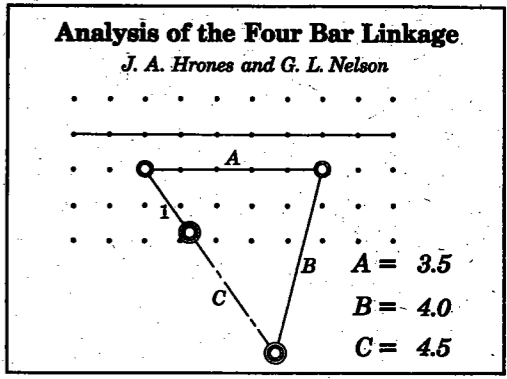

from  
Design of Machinery 4ed  
by Robert L. Norton  
McGraw-Hill  
Copyright 2008

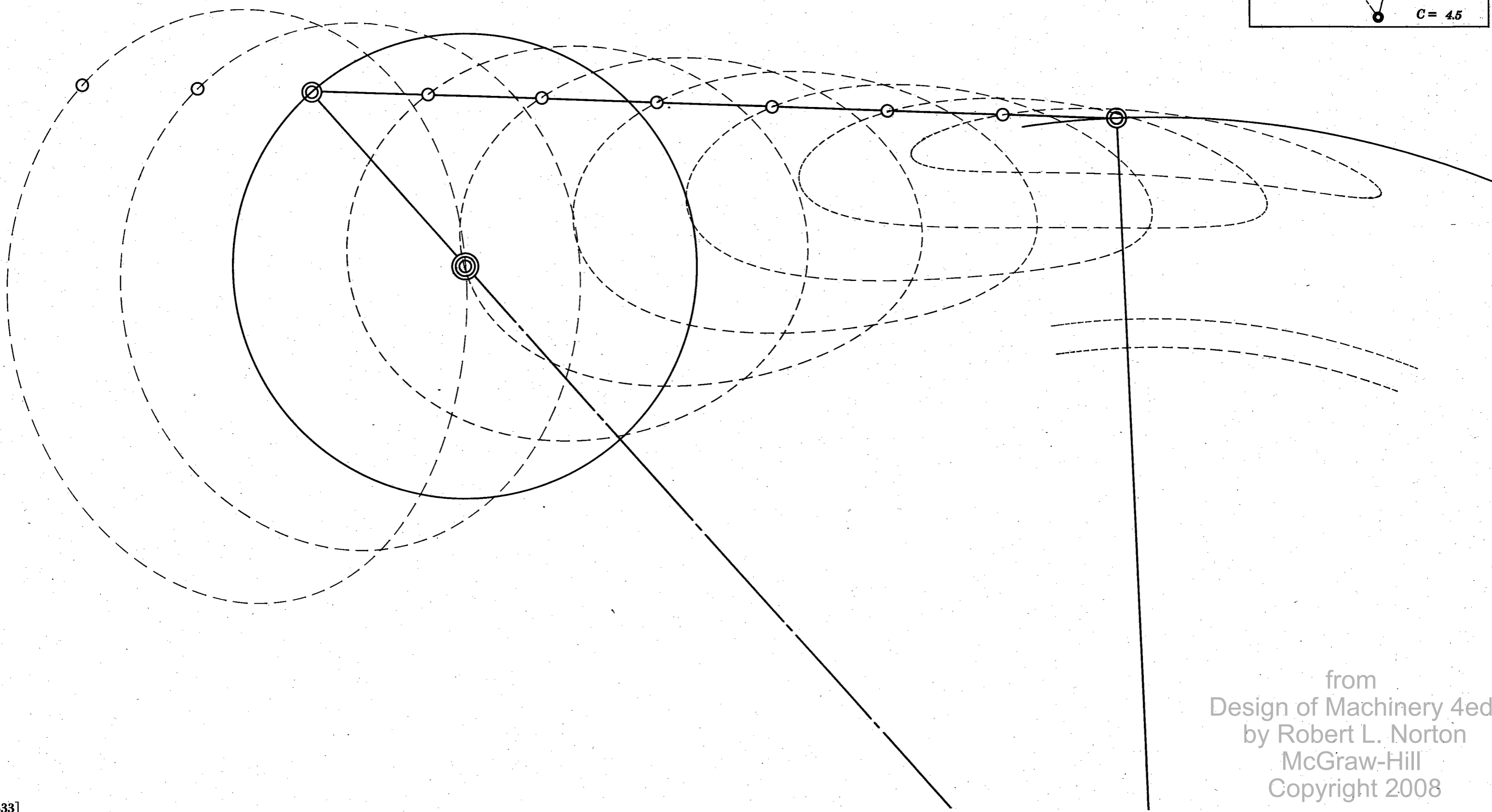
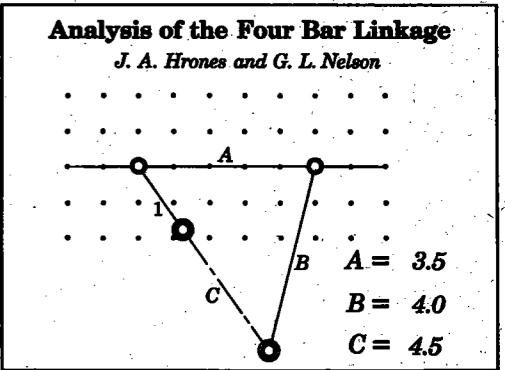

from  
 Design of Machinery 4ed  
 by Robert L. Norton  
 McGraw-Hill  
 Copyright 2008

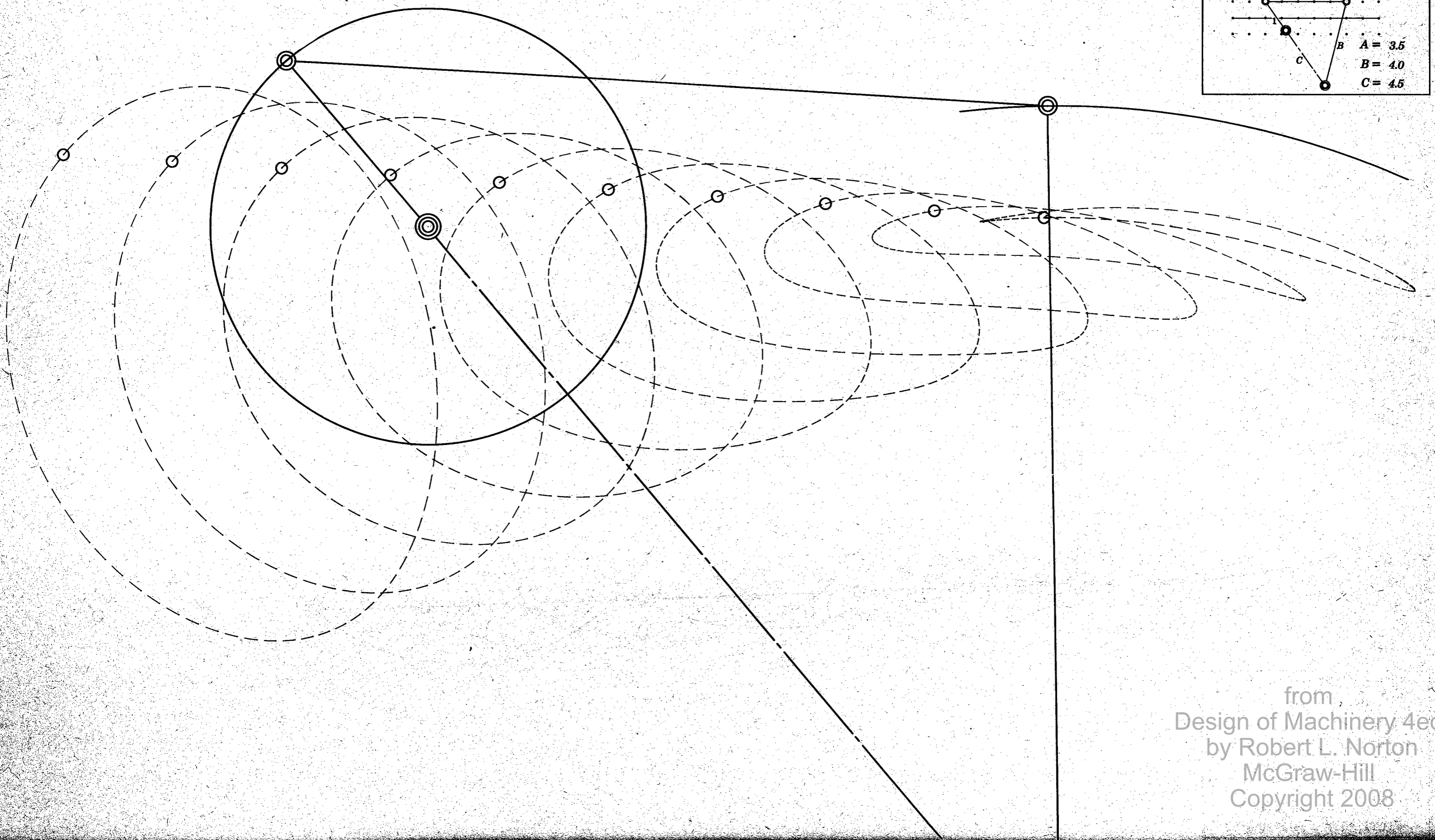
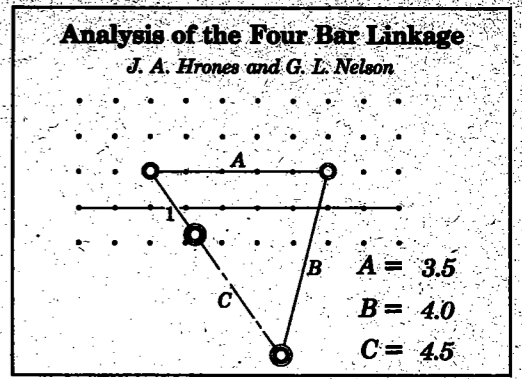

from  
Design of Machinery 4ed  
by Robert L. Norton  
McGraw-Hill  
Copyright 2008

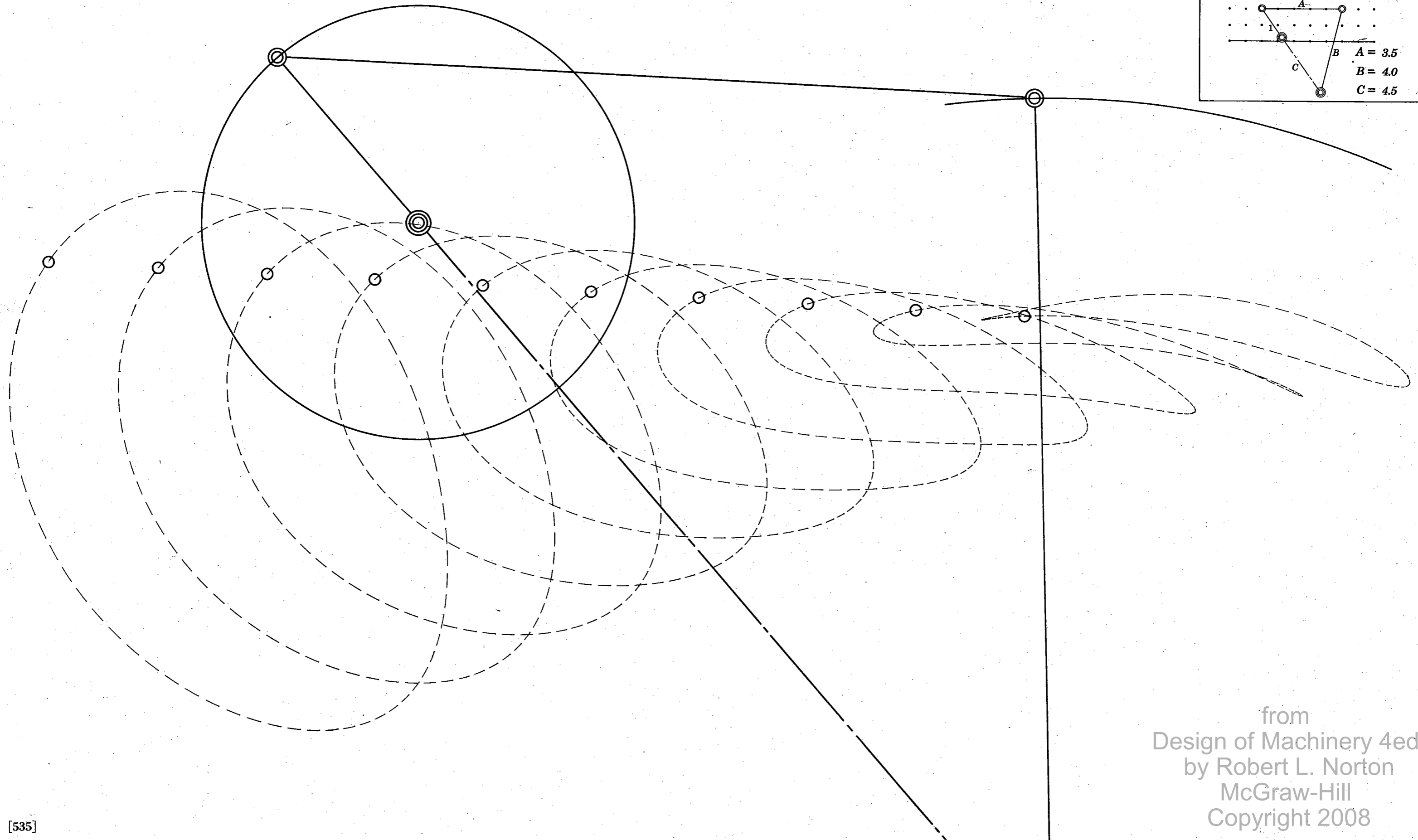
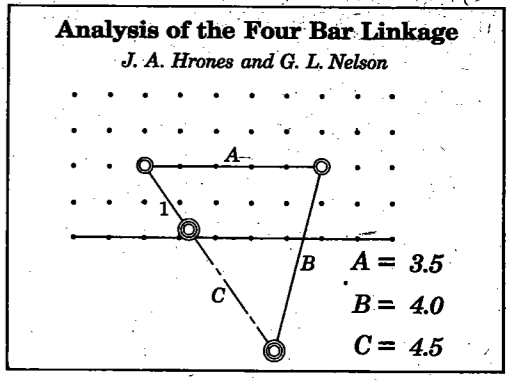

from  
 Design of Machinery 4ed  
 by Robert L. Norton  
 McGraw-Hill  
 Copyright 2008

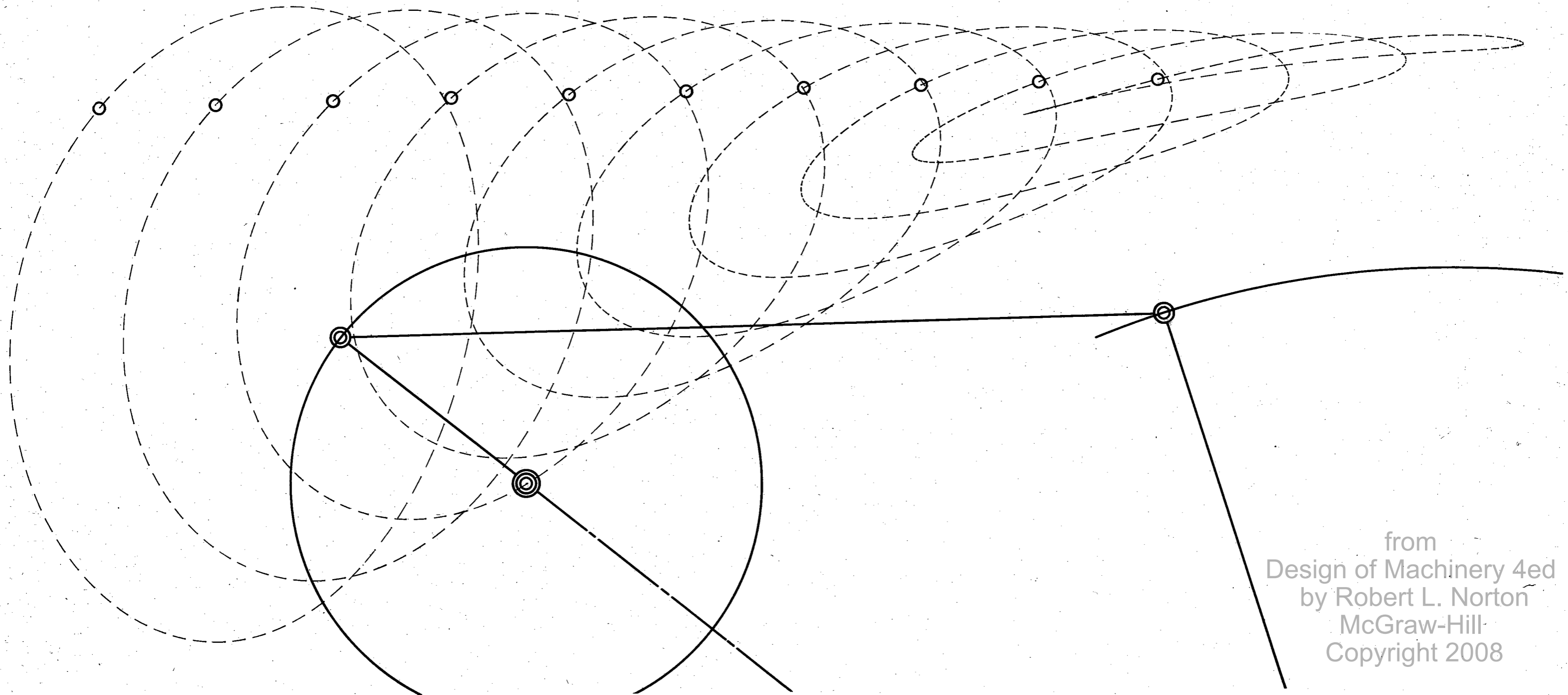
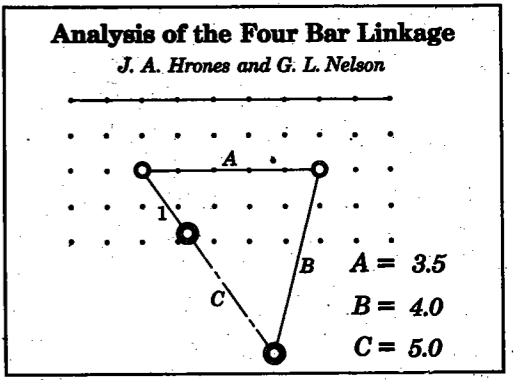

from  
Design of Machinery 4ed  
by Robert L. Norton  
McGraw-Hill  
Copyright 2008

**Analysis of the Four Bar Linkage**  
*J. A. Hrones and G. L. Nelson*

$A = 3.5$   
 $B = 4.0$   
 $C = 5.0$

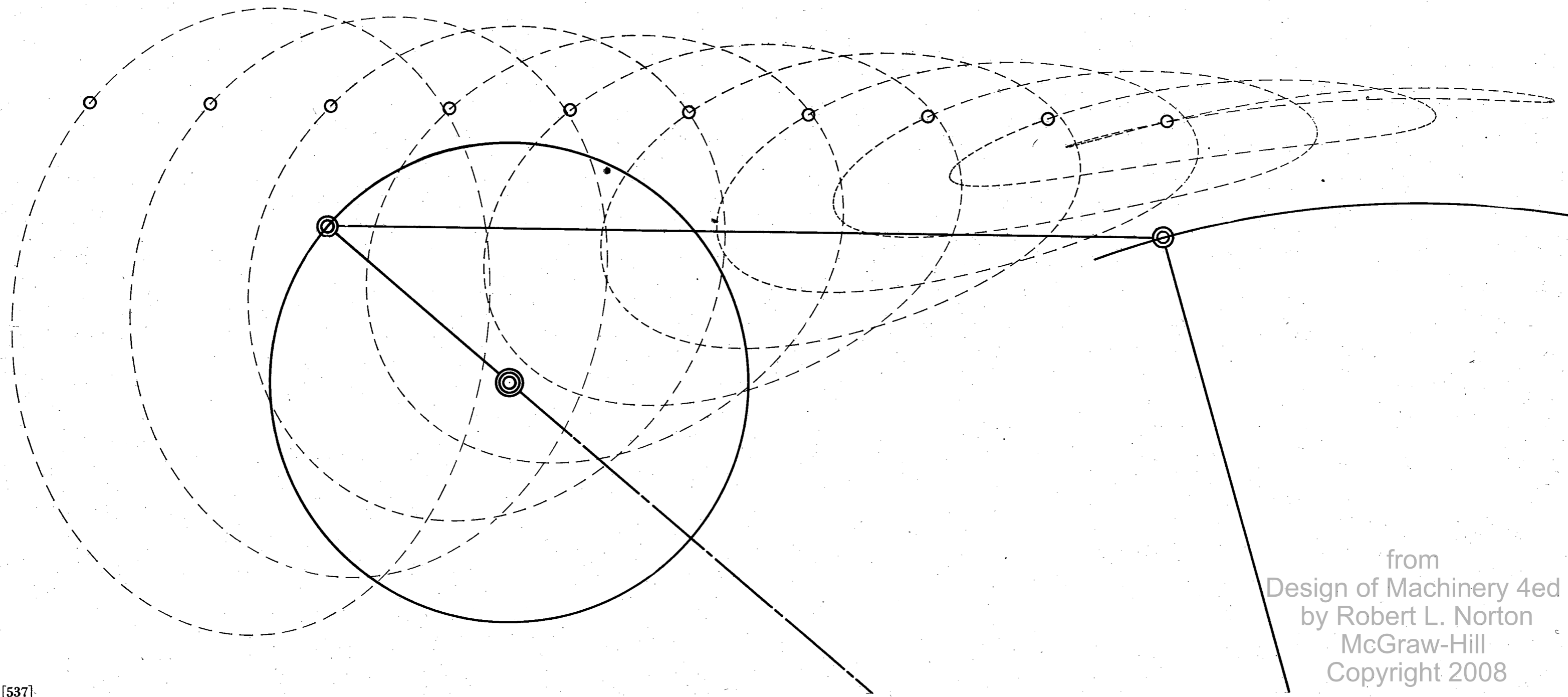

from  
 Design of Machinery 4ed  
 by Robert L. Norton  
 McGraw-Hill  
 Copyright 2008

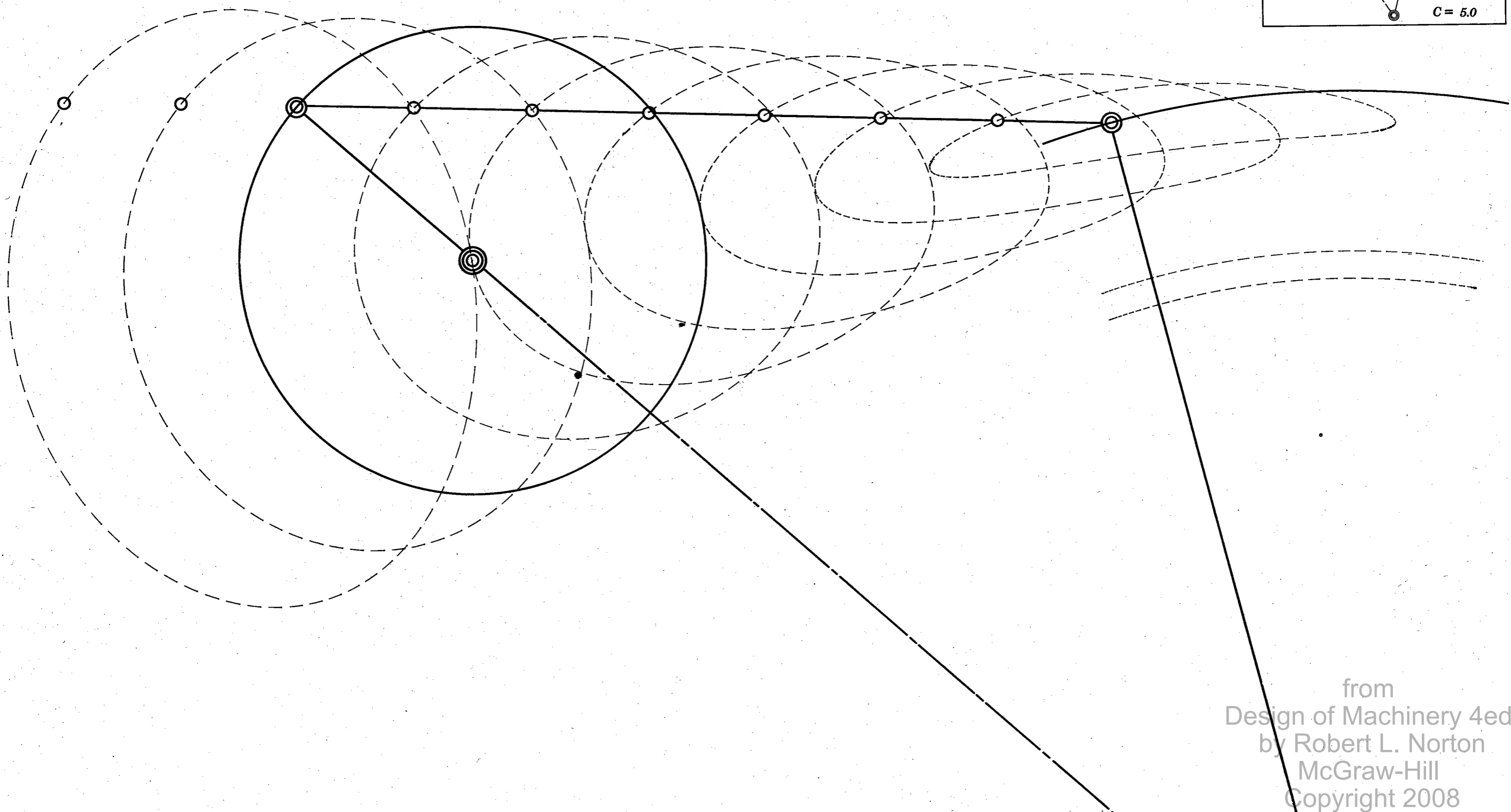
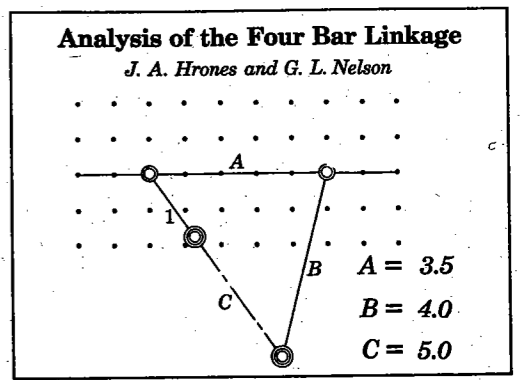

from  
Design of Machinery 4ed  
by Robert L. Norton  
McGraw-Hill  
Copyright 2008

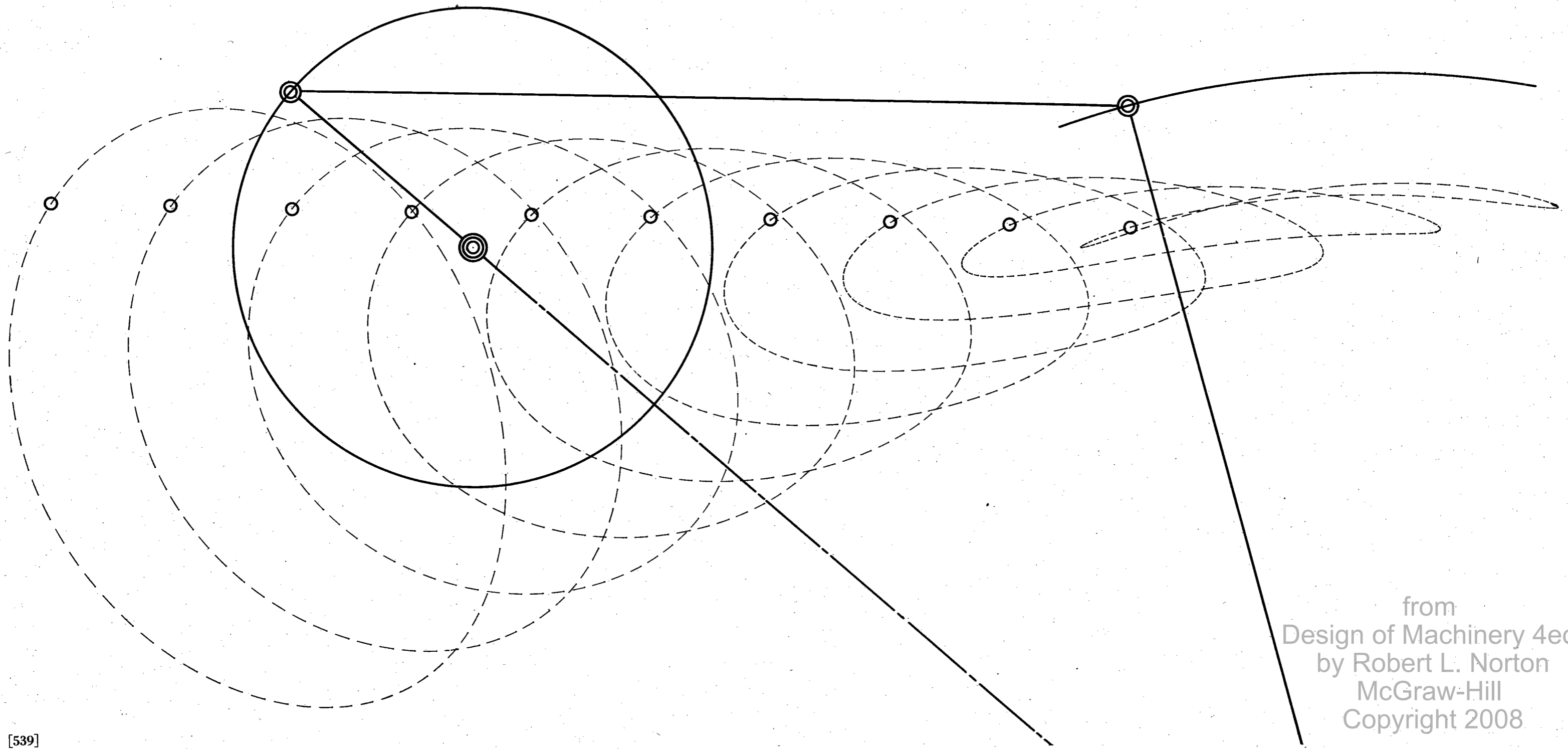
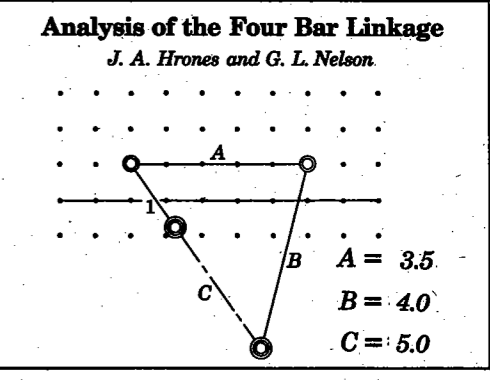

from  
 Design of Machinery 4ed  
 by Robert L. Norton  
 McGraw-Hill  
 Copyright 2008



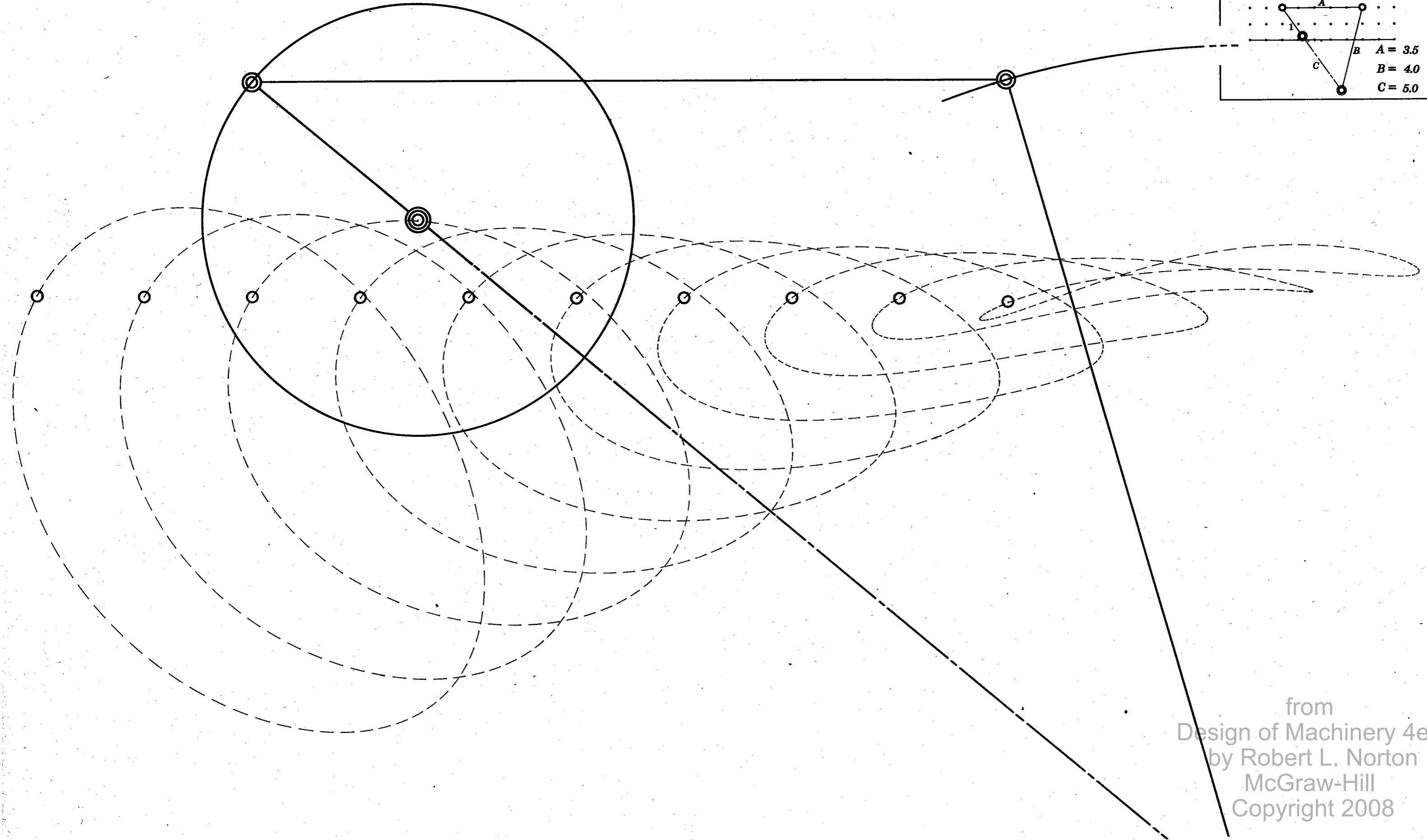
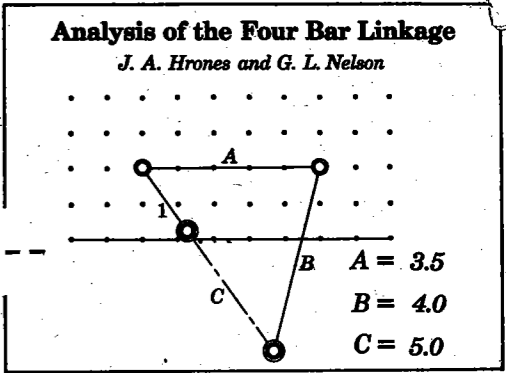

from  
Design of Machinery 4ed  
by Robert L. Norton  
McGraw-Hill  
Copyright 2008

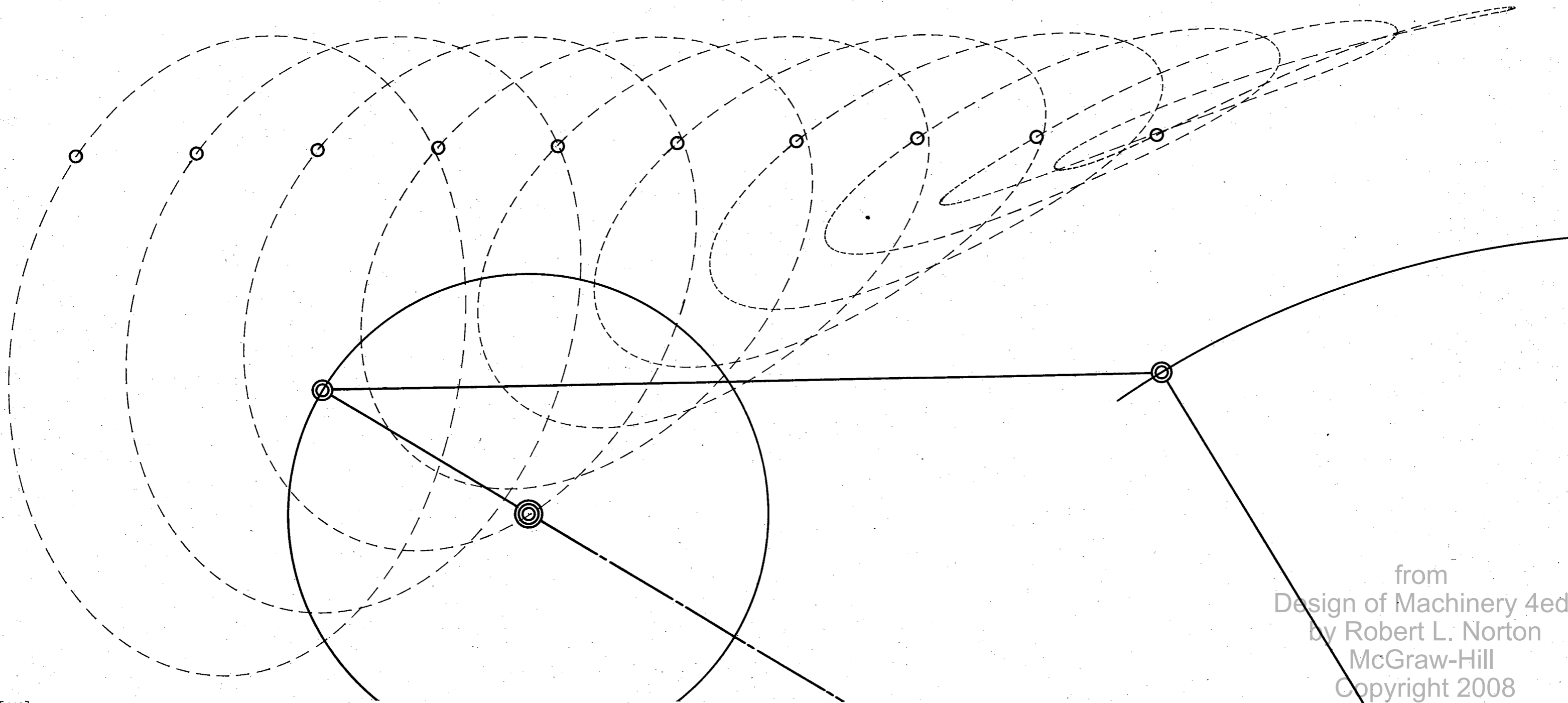
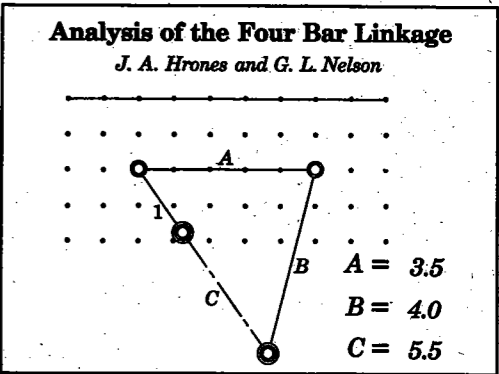

from  
 Design of Machinery 4ed  
 by Robert L. Norton  
 McGraw-Hill  
 Copyright 2008

**Analysis of the Four Bar Linkage**  
*J. A. Hrones and G. L. Nelson*

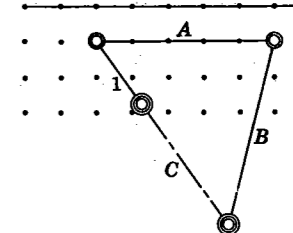

$A = 3.5$   
 $B = 4.0$   
 $C = 5.5$

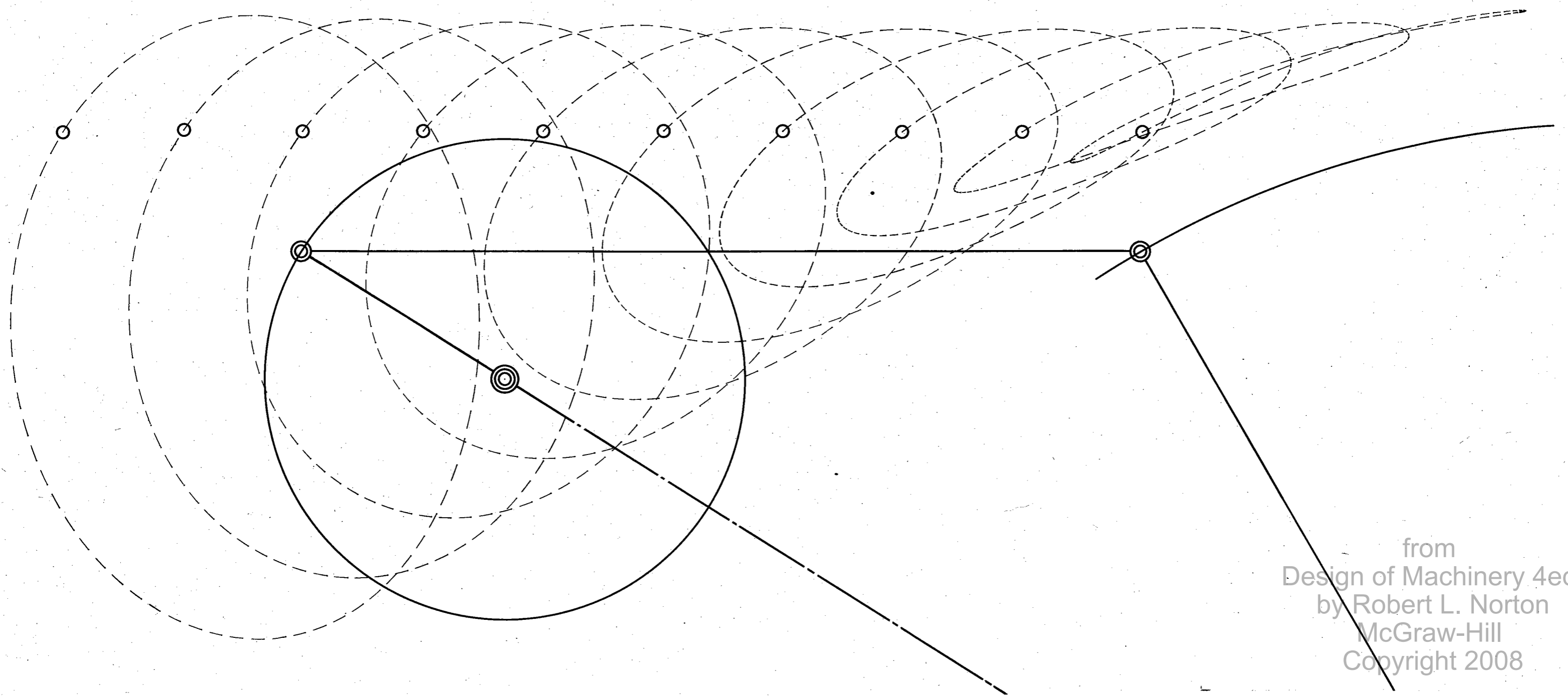

from  
Design of Machinery 4ed  
by Robert L. Norton  
McGraw-Hill  
Copyright 2008

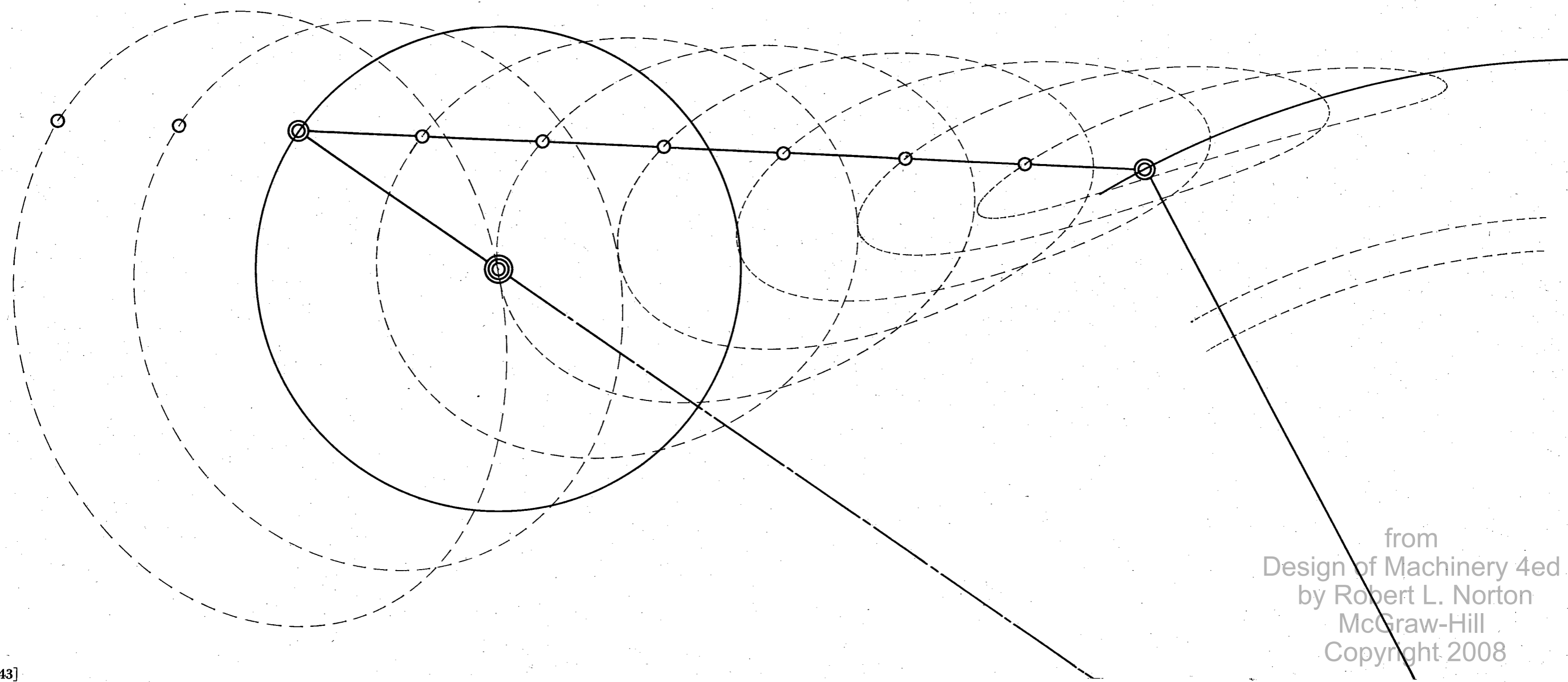
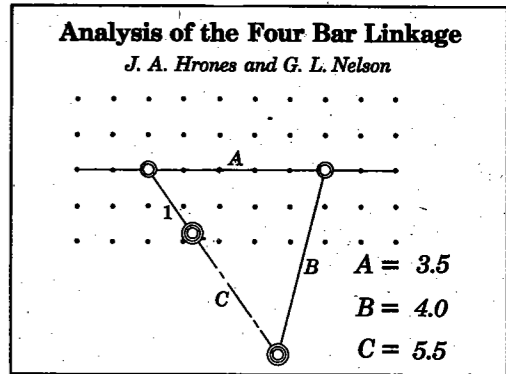

from  
 Design of Machinery 4ed  
 by Robert L. Norton  
 McGraw-Hill  
 Copyright 2008

**Analysis of the Four Bar Linkage**  
*J. A. Hrones and G. L. Nelson*

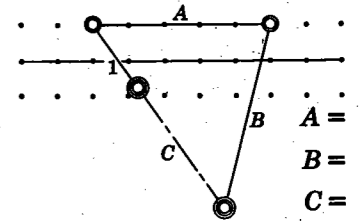

$A = 3.5$   
 $B = 4.0$   
 $C = 5.5$

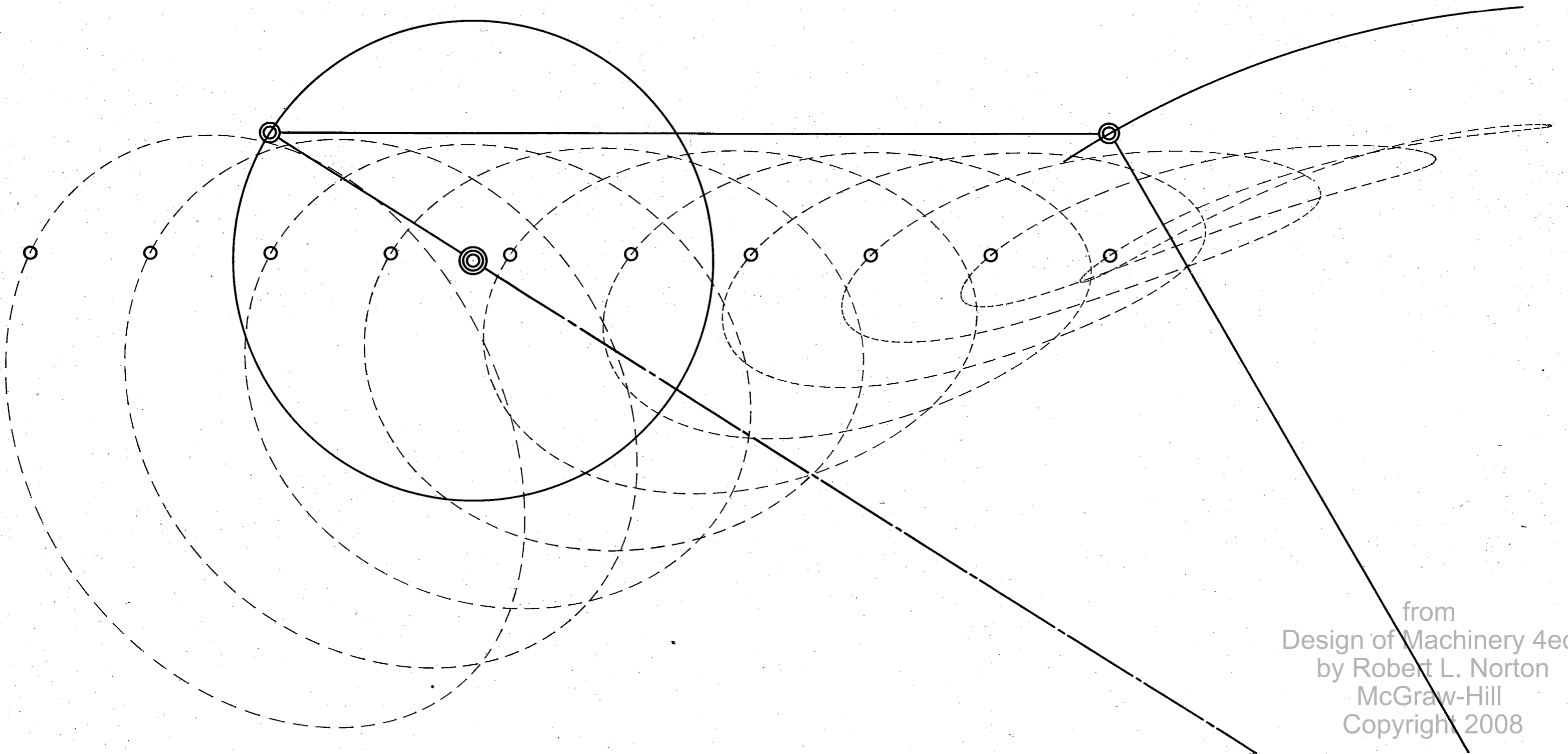

from  
Design of Machinery 4ed  
by Robert L. Norton  
McGraw-Hill  
Copyright 2008

**Analysis of the Four Bar Linkage**

*J. A. Hrones and G. L. Nelson*

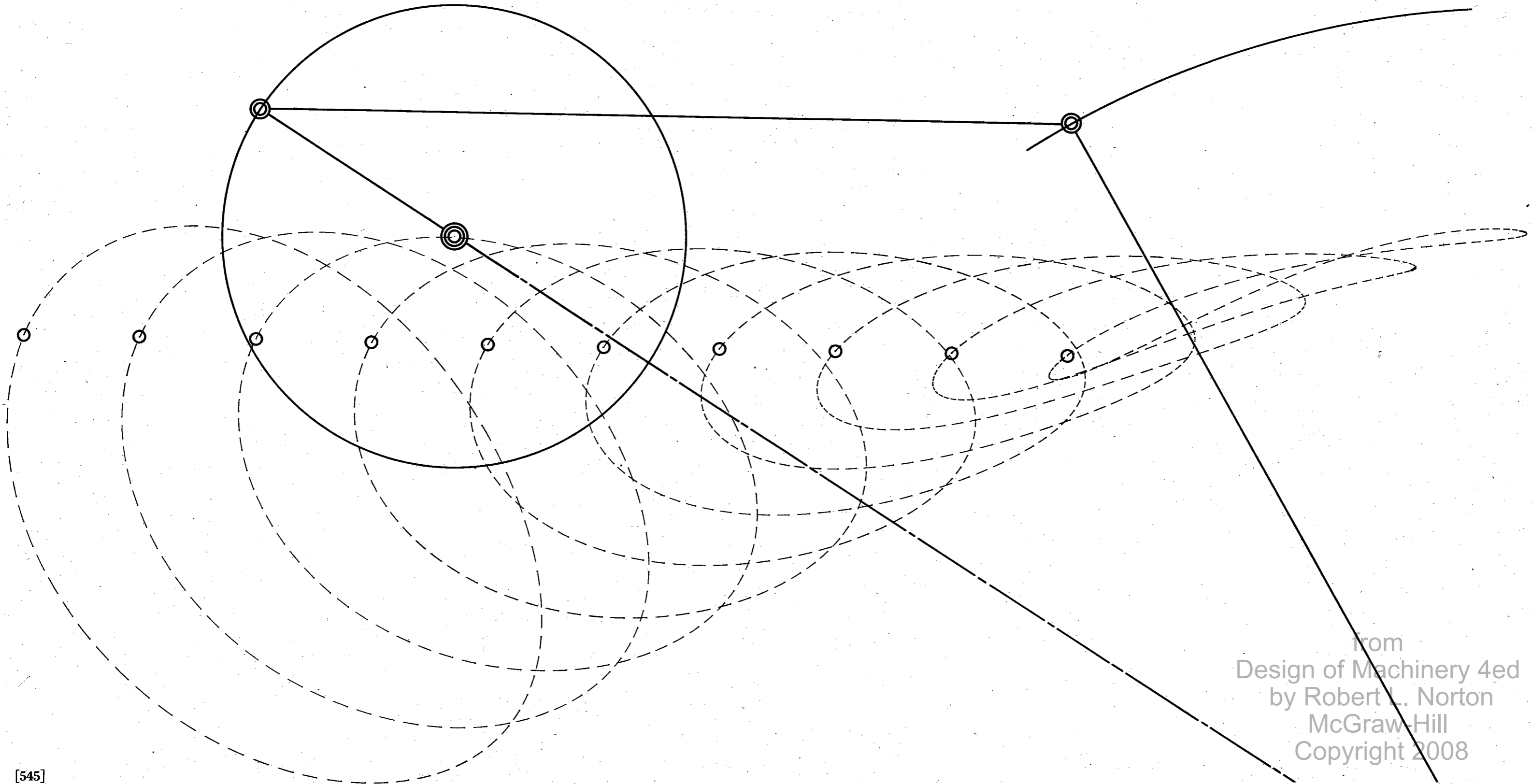
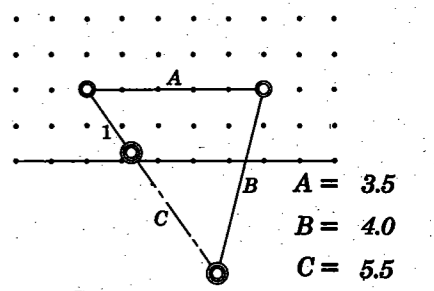

from  
Design of Machinery 4ed  
by Robert L. Norton  
McGraw-Hill  
Copyright 2008

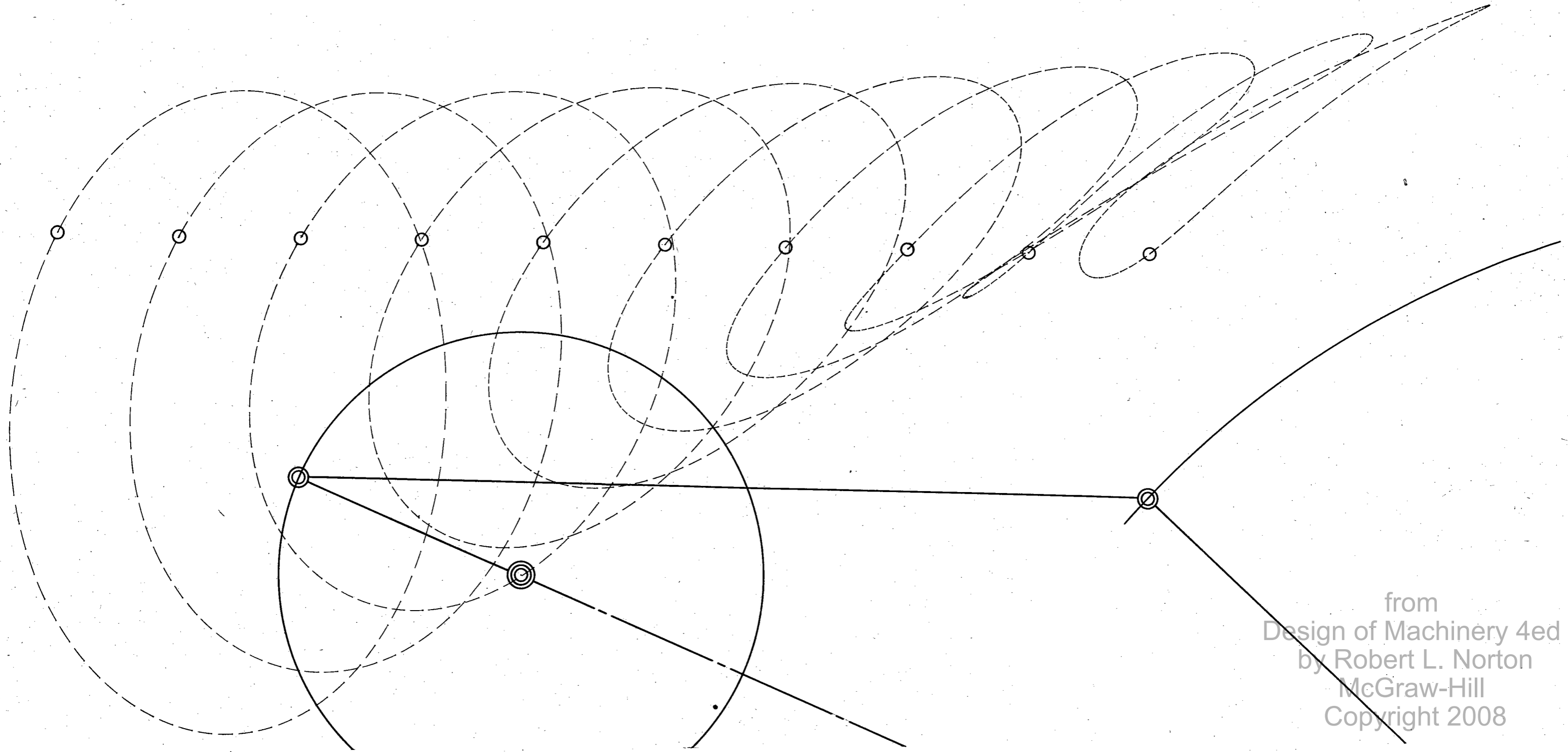
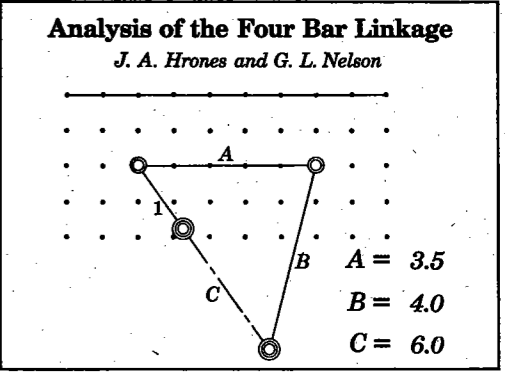

from  
Design of Machinery 4ed  
by Robert L. Norton  
McGraw-Hill  
Copyright 2008

**Analysis of the Four Bar Linkage**

*J. A. Hrones and G. L. Nelson*

.....

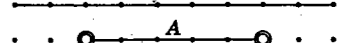

$A = 3.5$

$B = 4.0$

$C = 6.0$

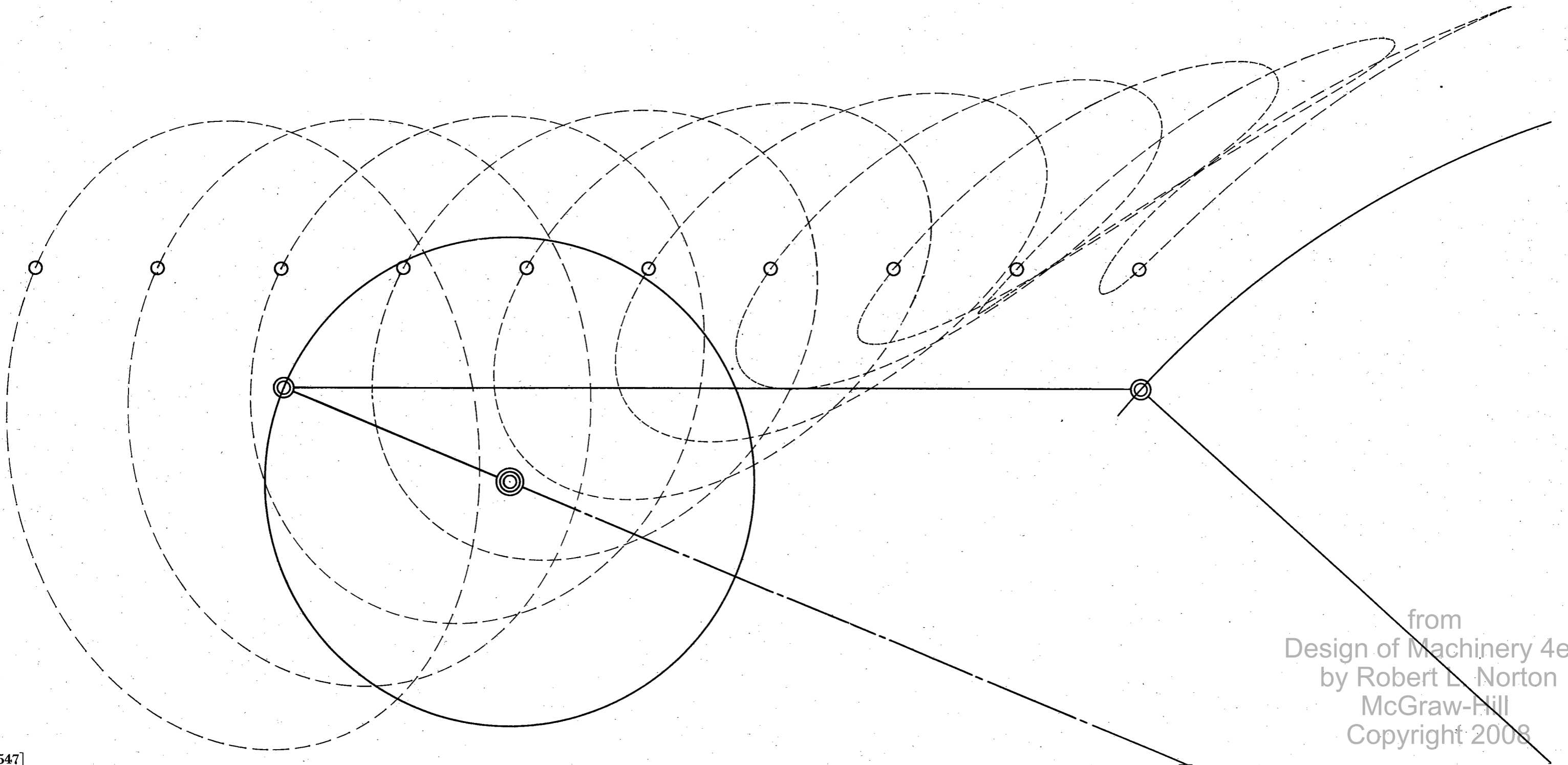

from  
Design of Machinery 4ed  
by Robert L. Norton  
McGraw-Hill  
Copyright 2008



**Analysis of the Four Bar Linkage**  
*J. A. Hrones and G. L. Nelson*

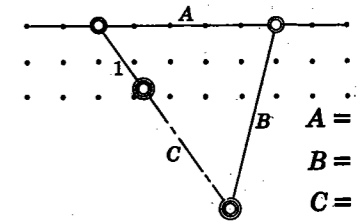

$A = 3.5$   
 $B = 4.0$   
 $C = 6.0$

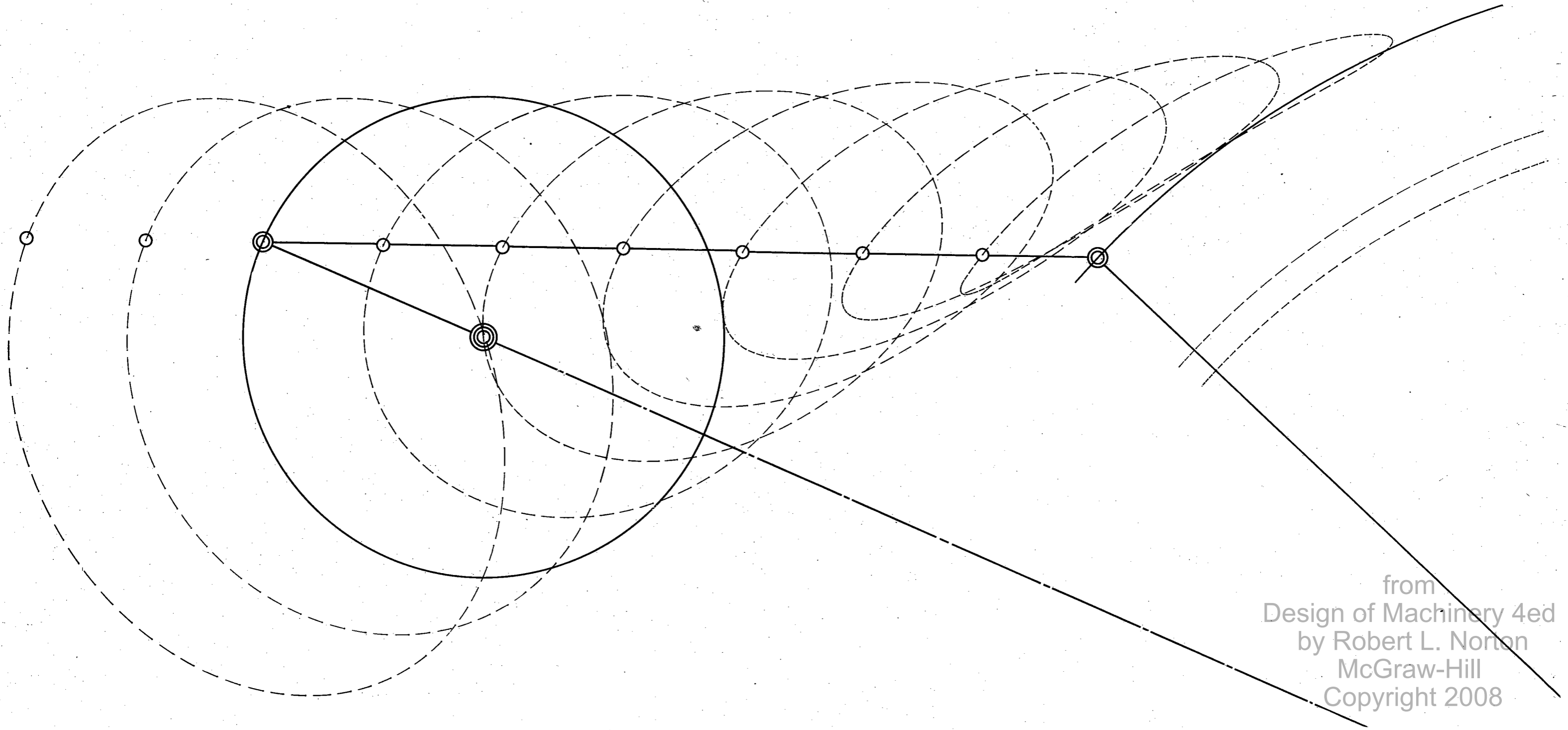

from  
Design of Machinery 4ed  
by Robert L. Norton  
McGraw-Hill  
Copyright 2008

**Analysis of the Four Bar Linkage**

*J. A. Hrones and G. L. Nelson*

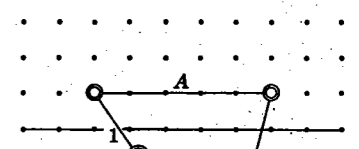

$A = 3.5$   
 $B = 4.0$   
 $C = 6.0$

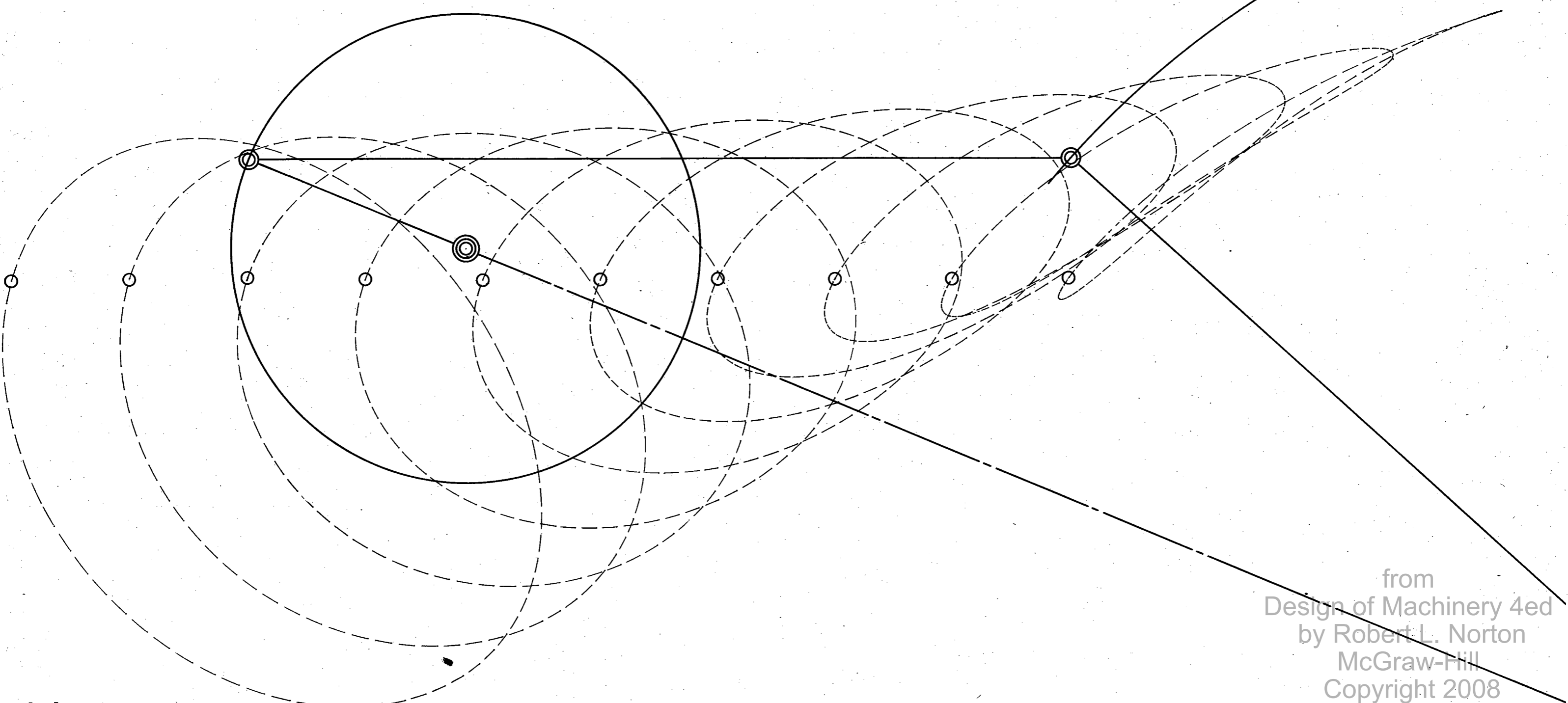

from  
Design of Machinery 4ed  
by Robert L. Norton  
McGraw-Hill  
Copyright 2008

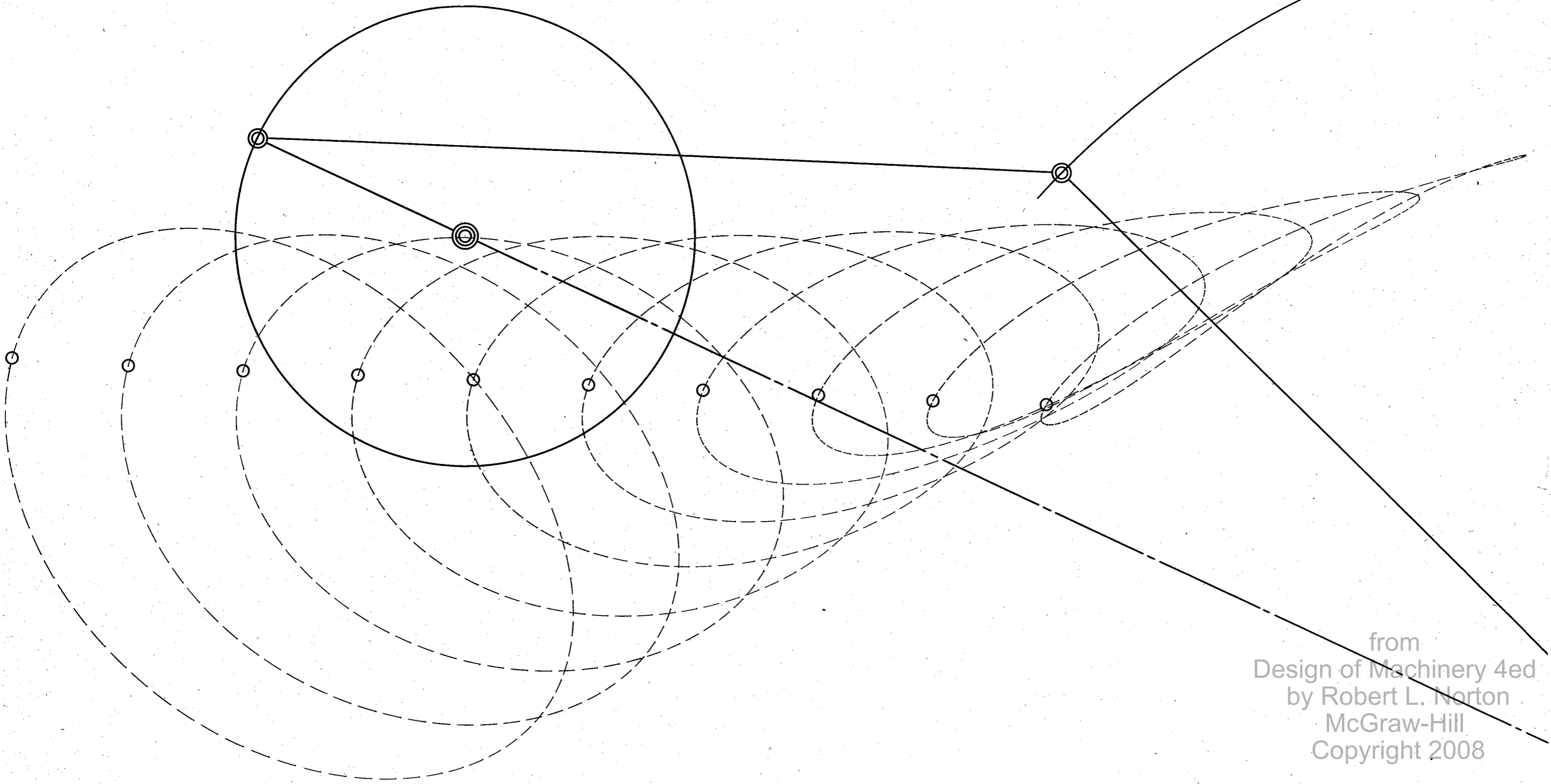
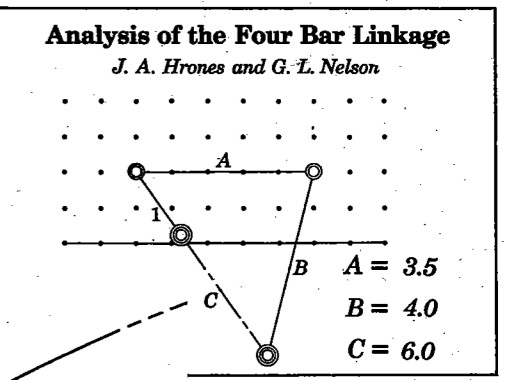

from  
Design of Machinery 4ed  
by Robert L. Norton  
McGraw-Hill  
Copyright 2008

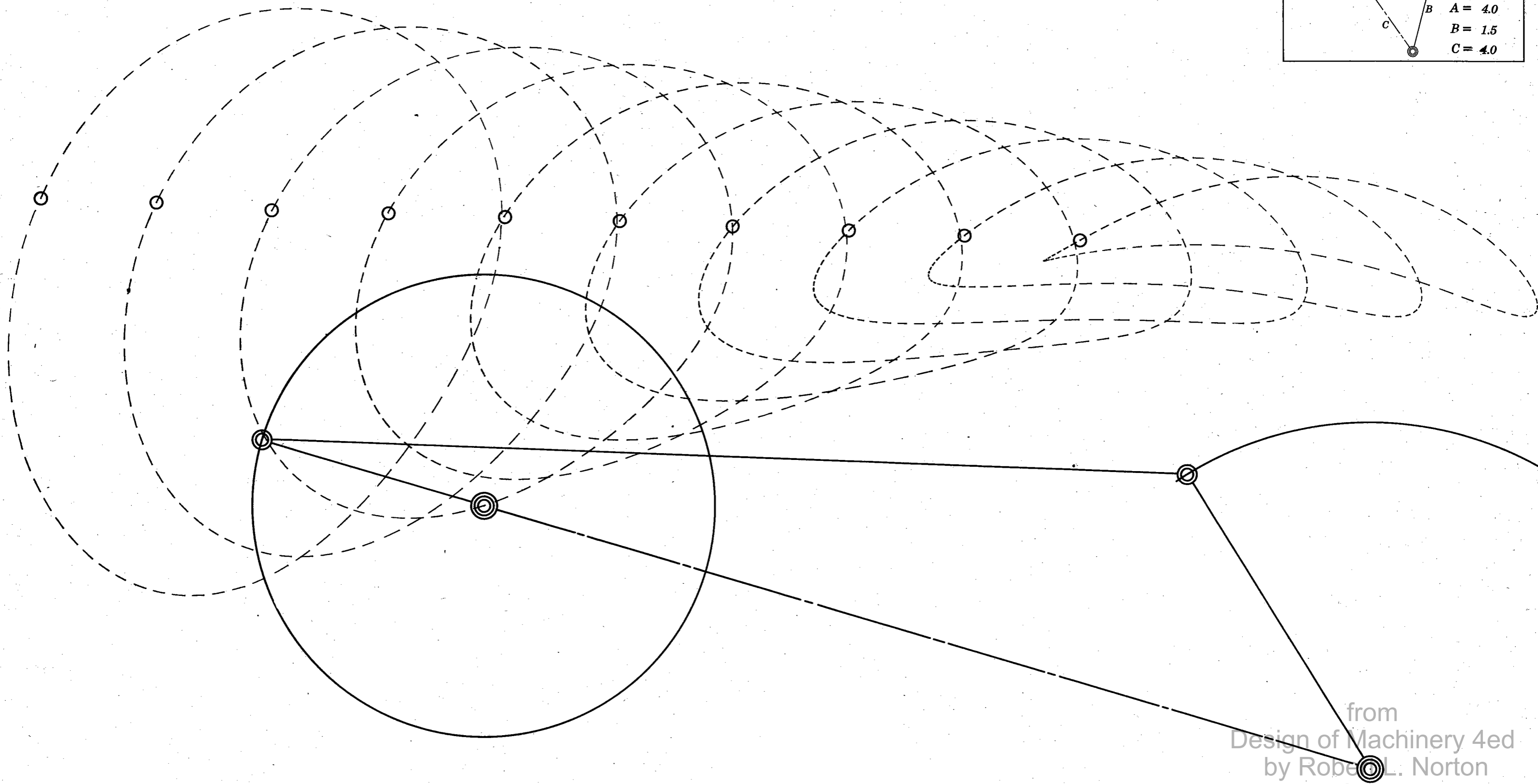
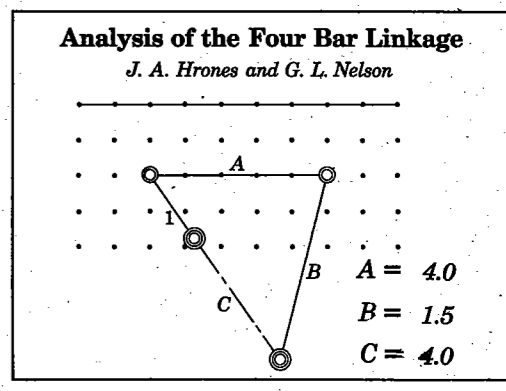

from  
 Design of Machinery 4ed  
 by Robert L. Norton  
 McGraw-Hill  
 Copyright 2008

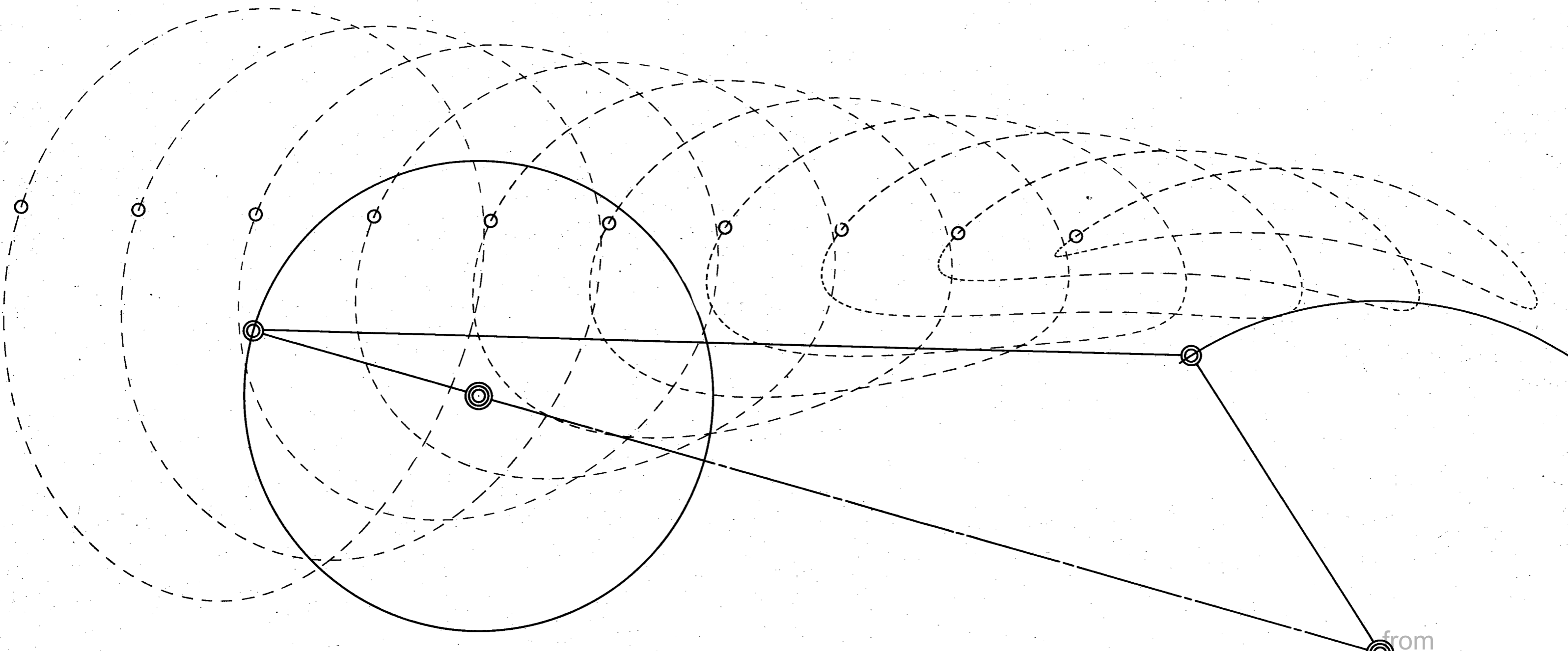
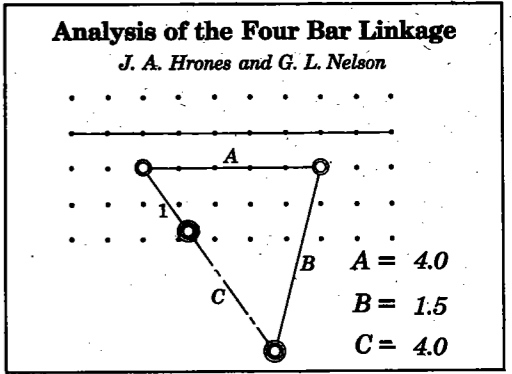

from  
Design of Machinery 4ed  
by Robert L. Norton  
McGraw-Hill  
Copyright 2008

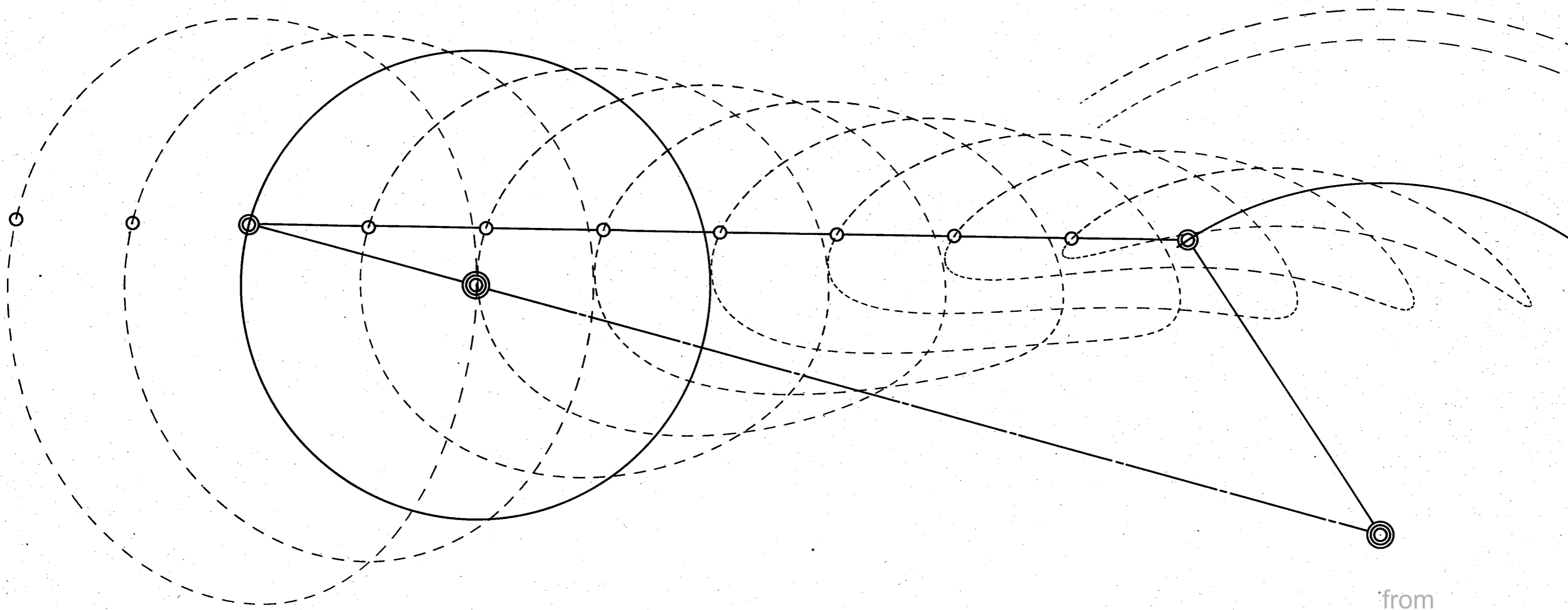
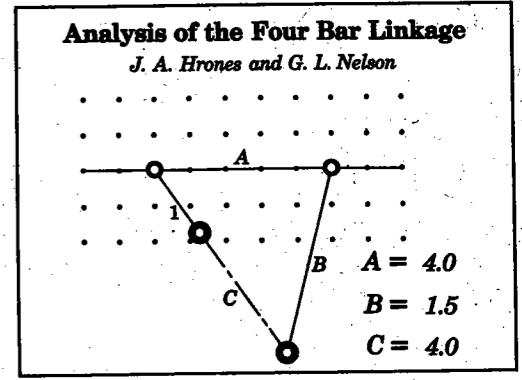

from  
 Design of Machinery 4ed  
 by Robert L. Norton  
 McGraw-Hill  
 Copyright 2008

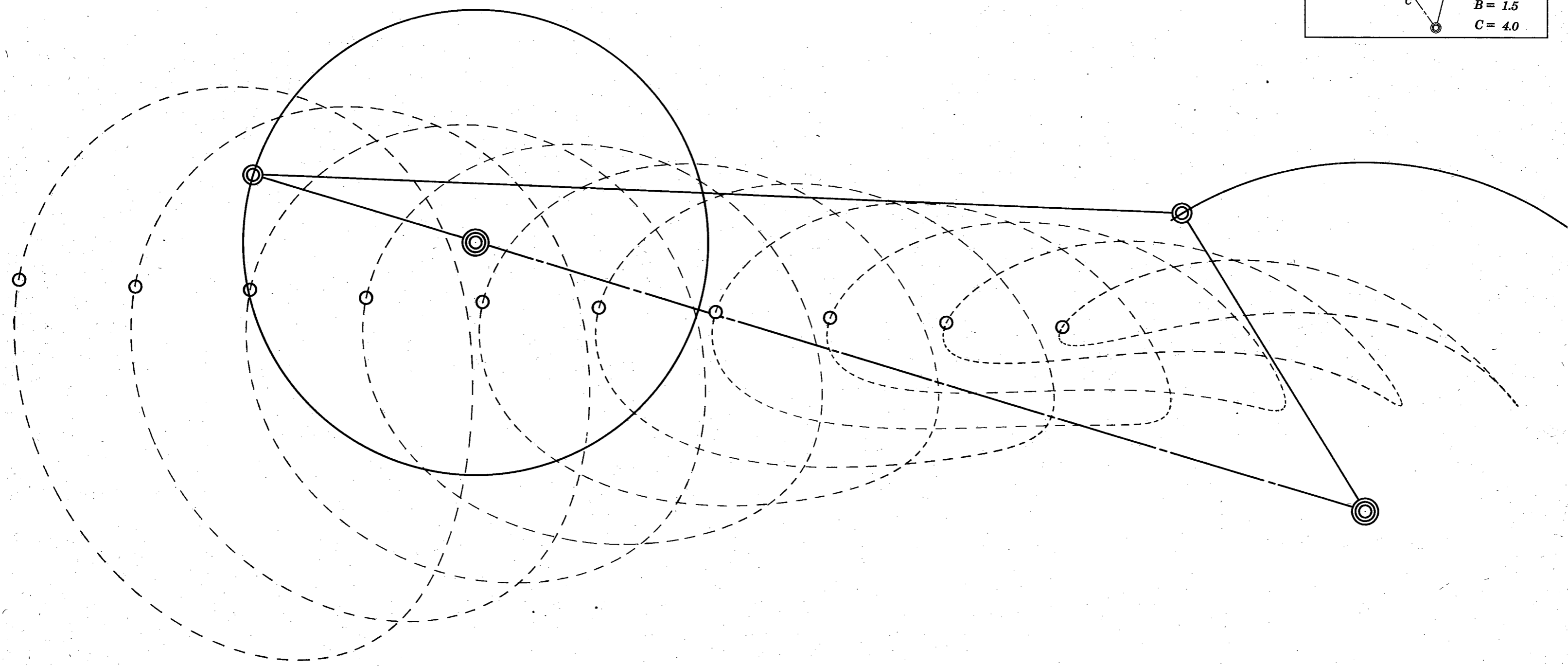
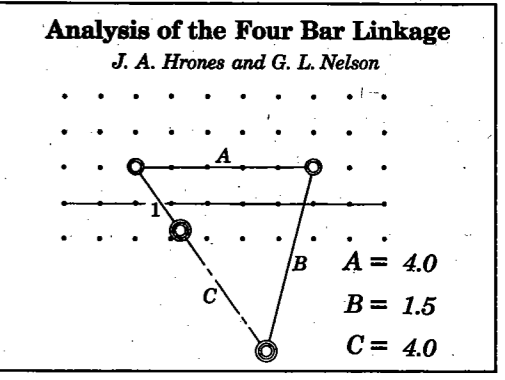

from  
Design of Machinery 4ed  
by Robert L. Norton  
McGraw-Hill  
Copyright 2008

**Analysis of the Four Bar Linkage**

*J. A. Hrones and G. L. Nelson*

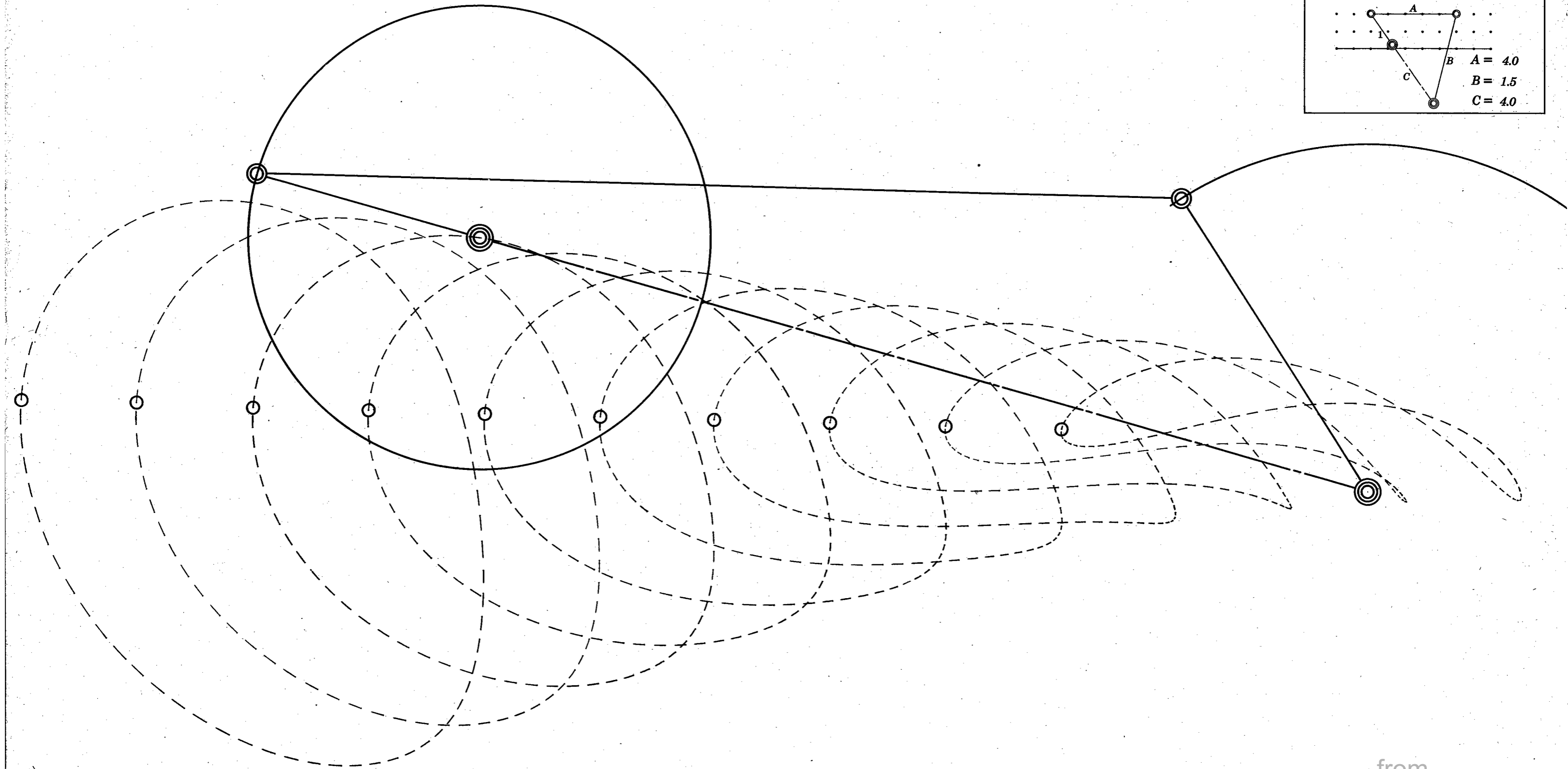
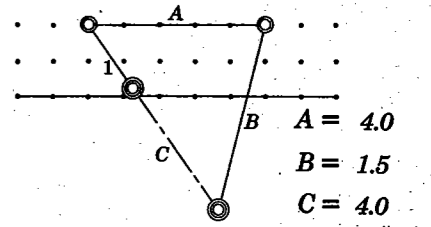

from  
Design of Machinery 4ed  
by Robert L. Norton  
McGraw-Hill  
Copyright 2008



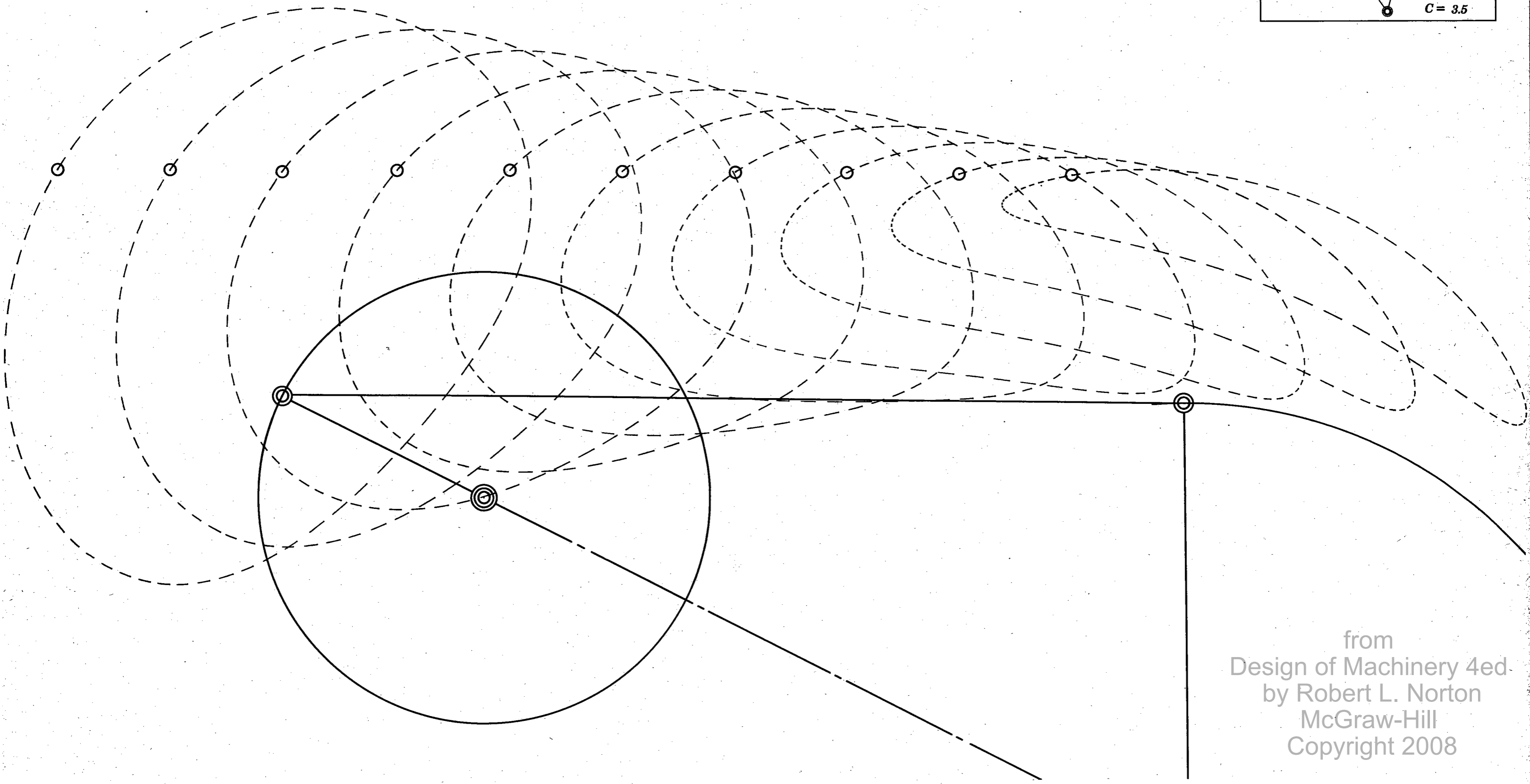
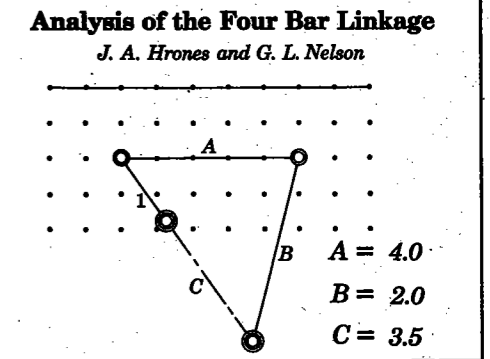

from  
Design of Machinery 4ed  
by Robert L. Norton  
McGraw-Hill  
Copyright 2008

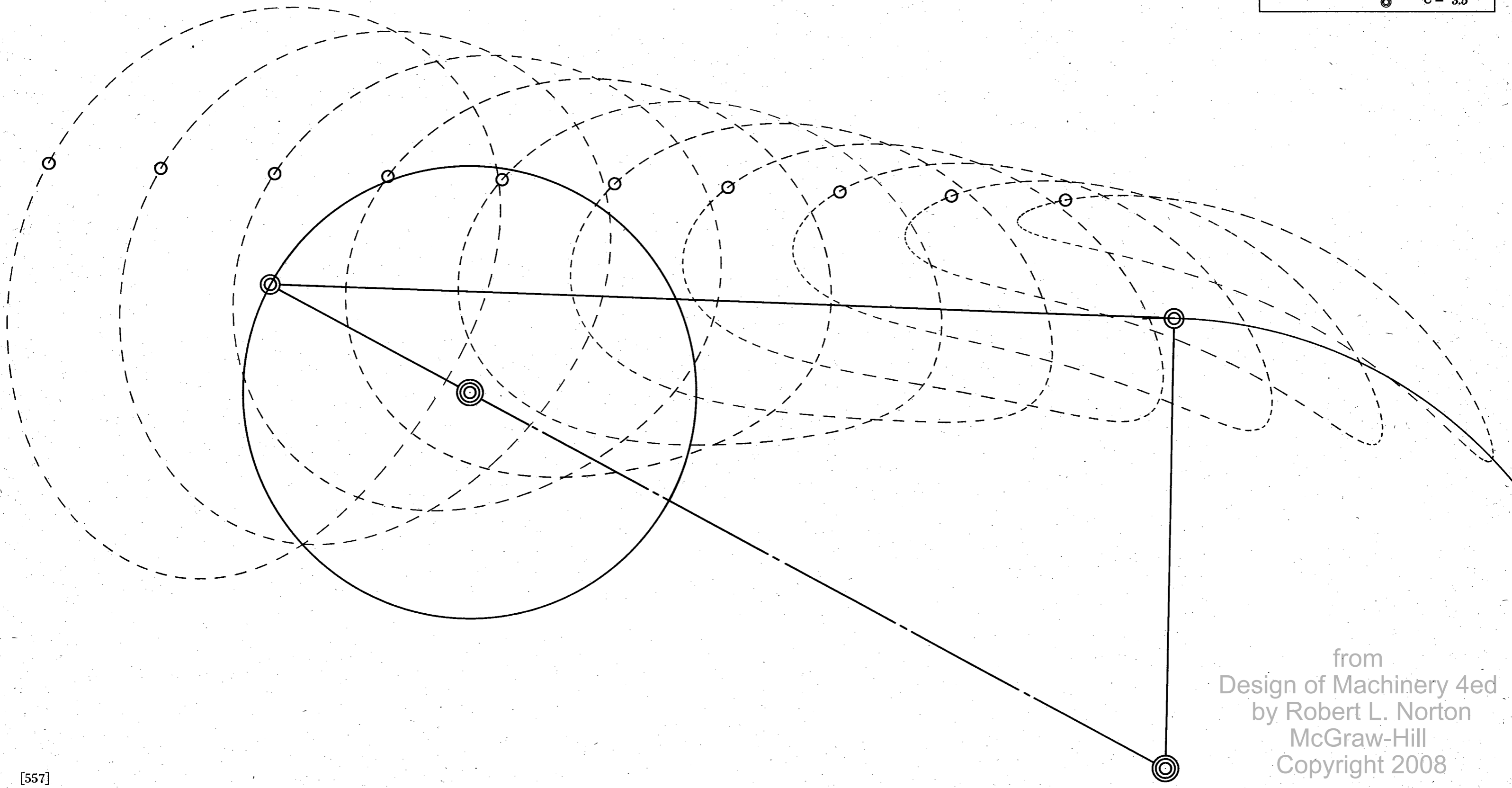
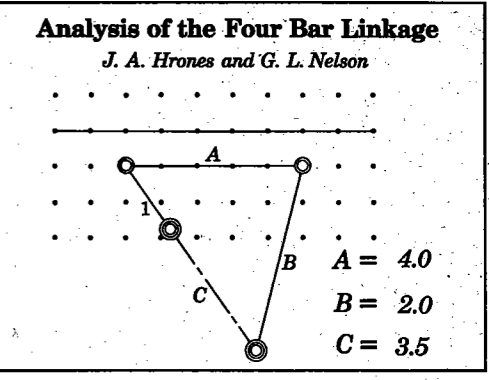

from  
 Design of Machinery 4ed  
 by Robert L. Norton  
 McGraw-Hill  
 Copyright 2008

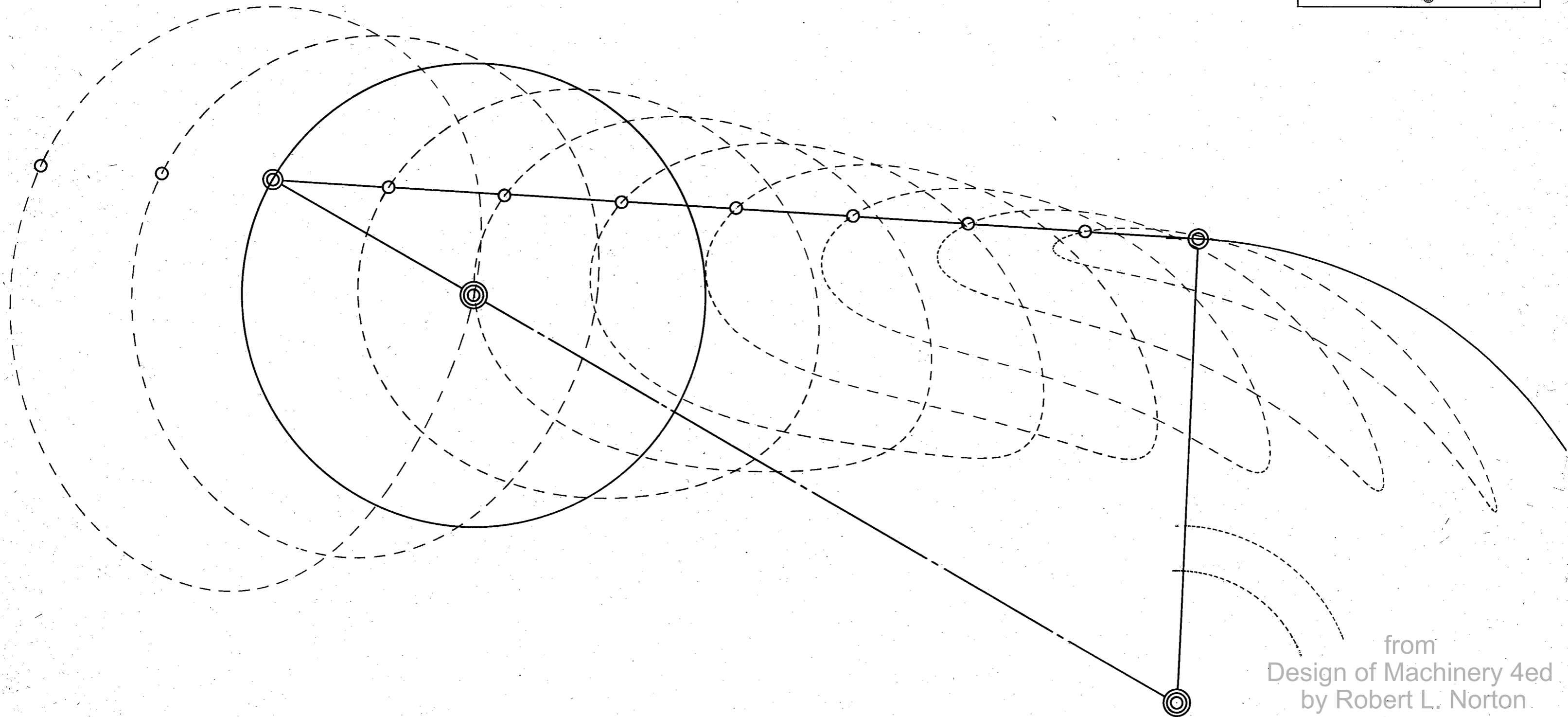
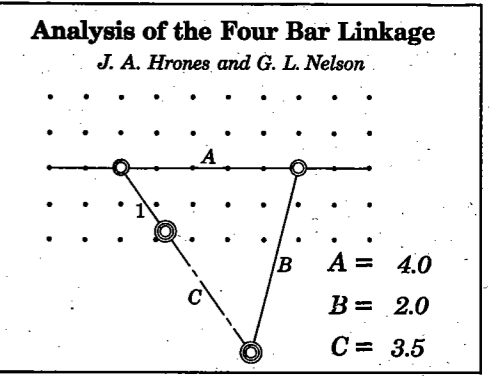

from  
Design of Machinery 4ed  
by Robert L. Norton  
McGraw-Hill  
Copyright 2008

**Analysis of the Four Bar Linkage**  
*J. A. Hrones and G. L. Nelson*

$A = 4.0$   
 $B = 2.0$   
 $C = 3.5$

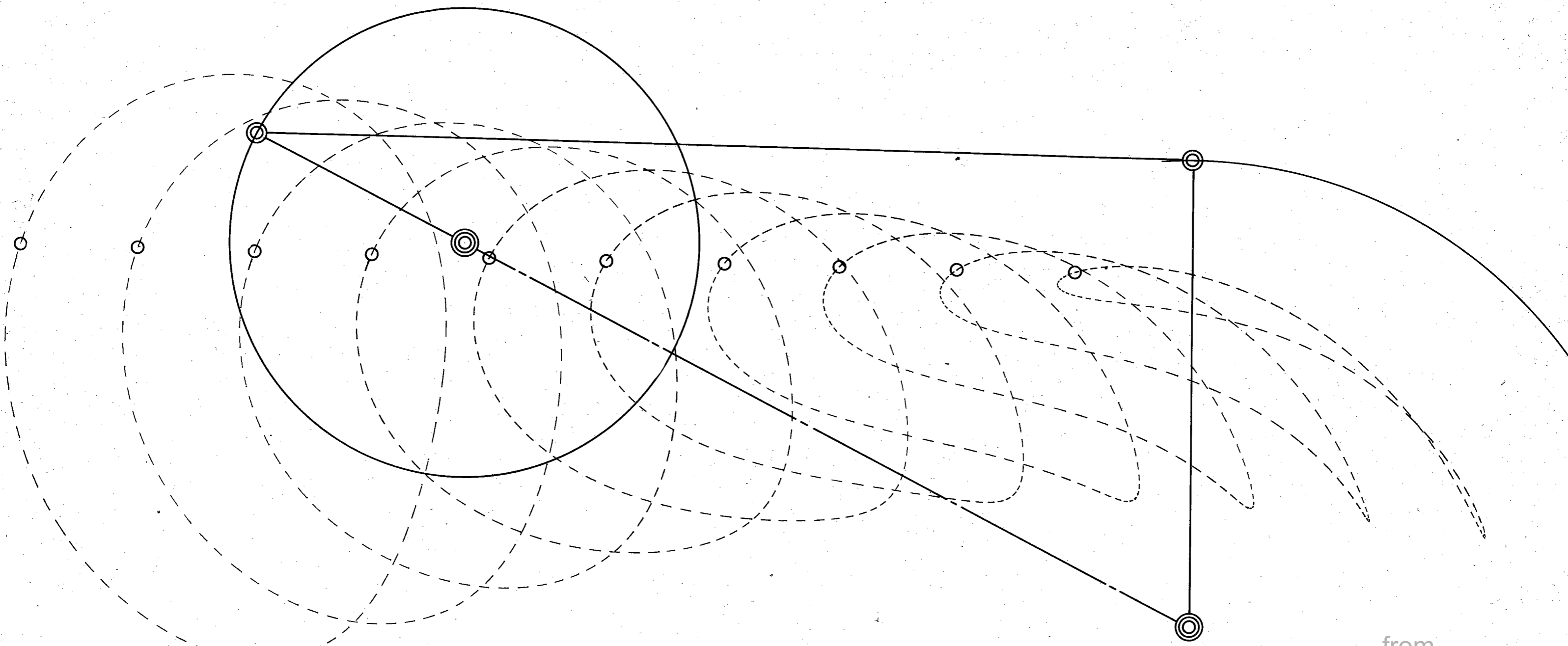

from  
 Design of Machinery 4ed  
 by Robert L. Norton  
 McGraw-Hill  
 Copyright 2008

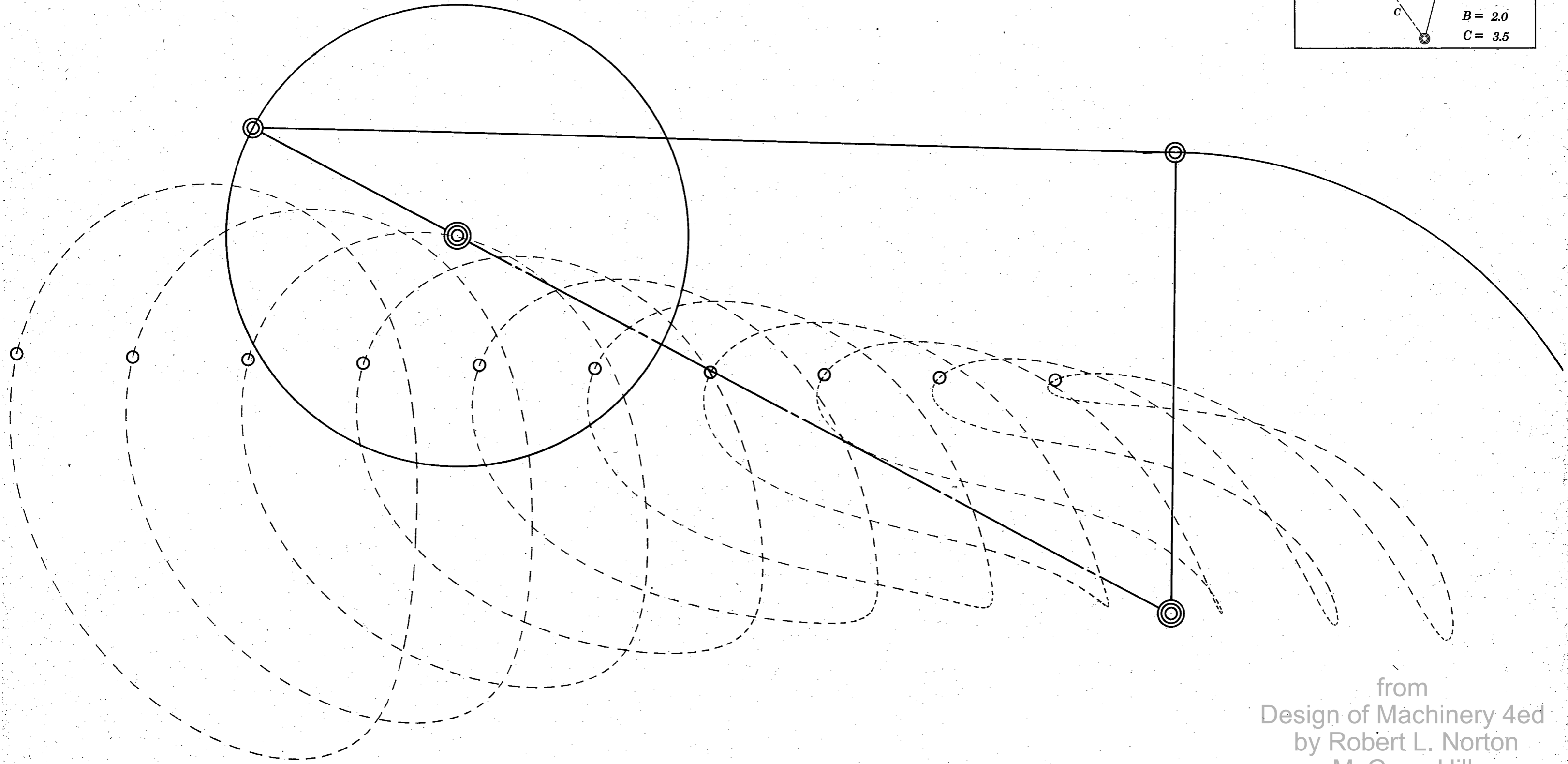
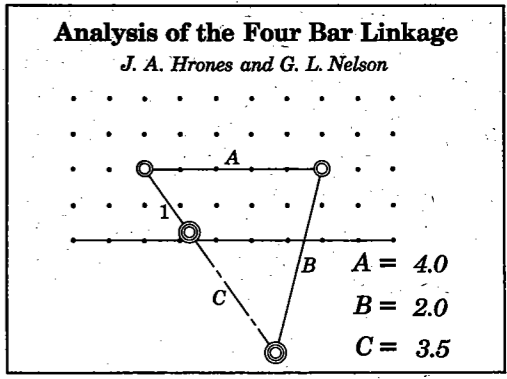

from  
Design of Machinery 4ed  
by Robert L. Norton  
McGraw-Hill  
Copyright 2008

**Analysis of the Four Bar Linkage**

*J. A. Hrones and G. L. Nelson*

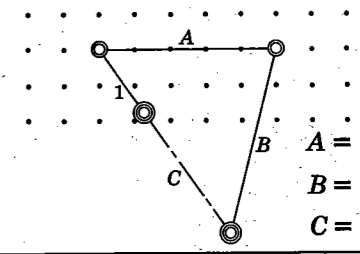
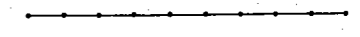

$A = 4.0$   
 $B = 2.0$   
 $C = 4.0$

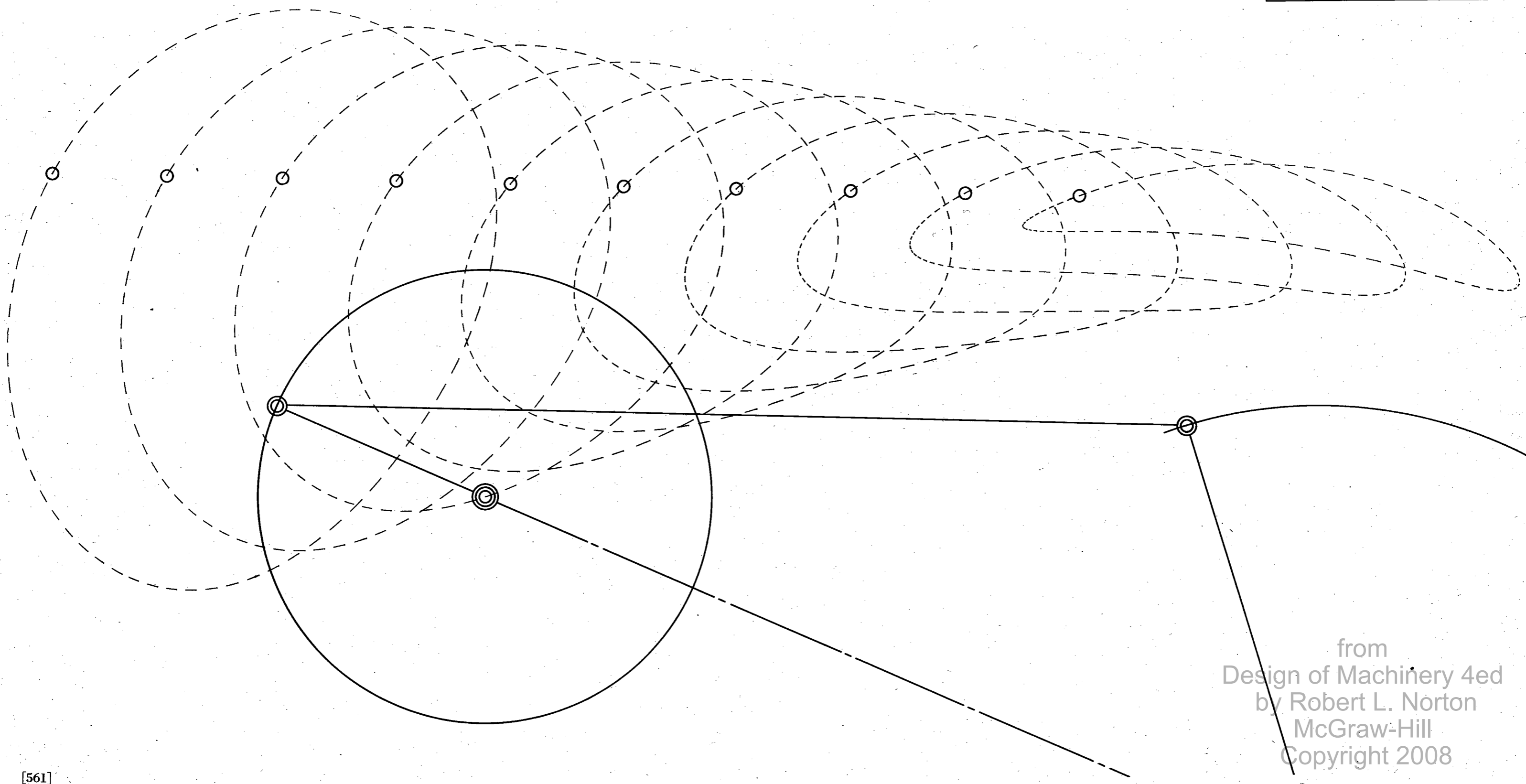

from  
Design of Machinery 4ed  
by Robert L. Norton  
McGraw-Hill  
Copyright 2008

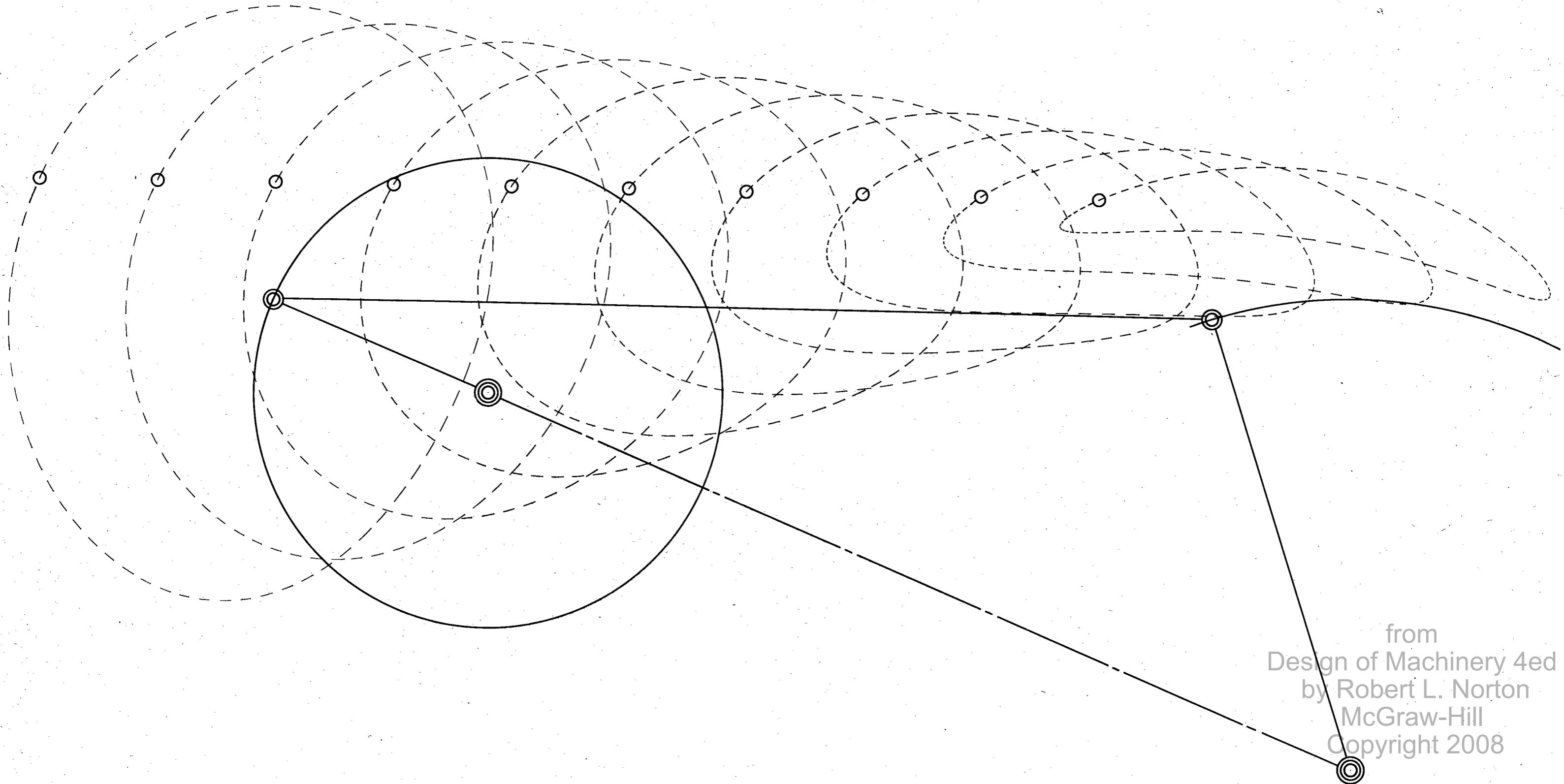
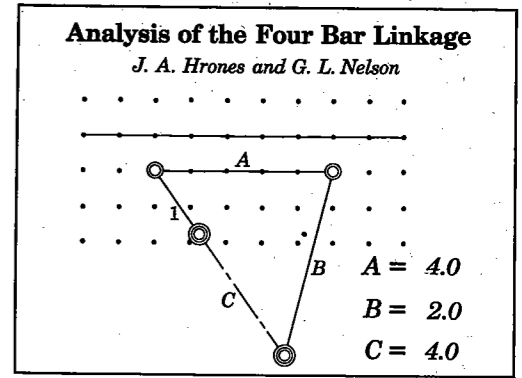

from  
Design of Machinery 4ed  
by Robert L. Norton  
McGraw-Hill  
Copyright 2008

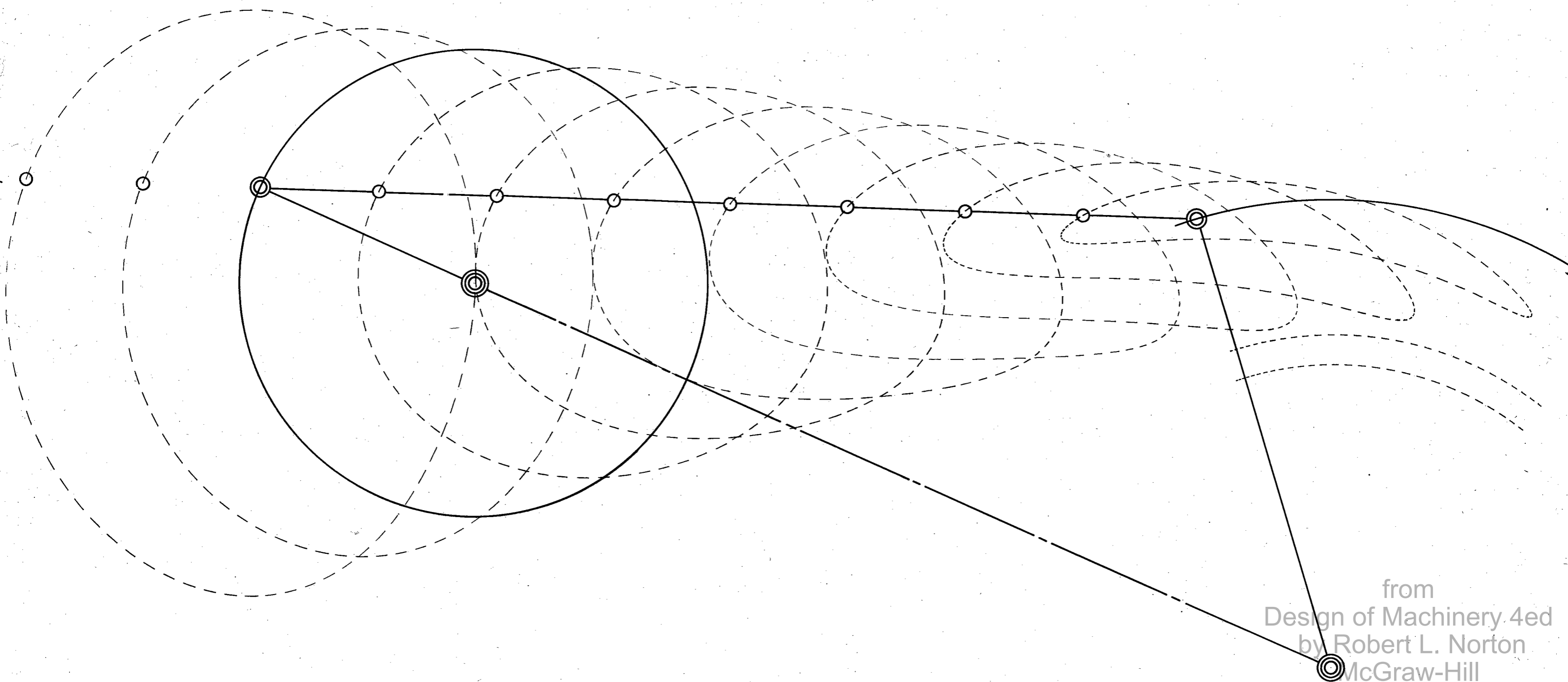
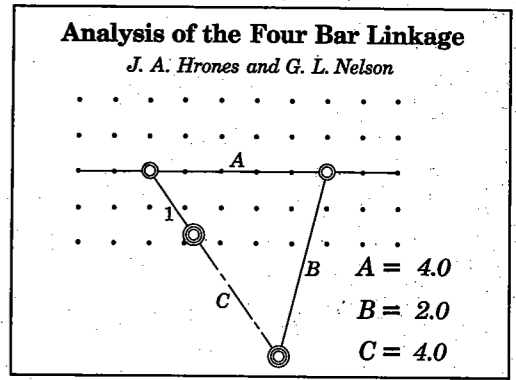

from  
 Design of Machinery 4ed  
 by Robert L. Norton  
 McGraw-Hill  
 Copyright 2008



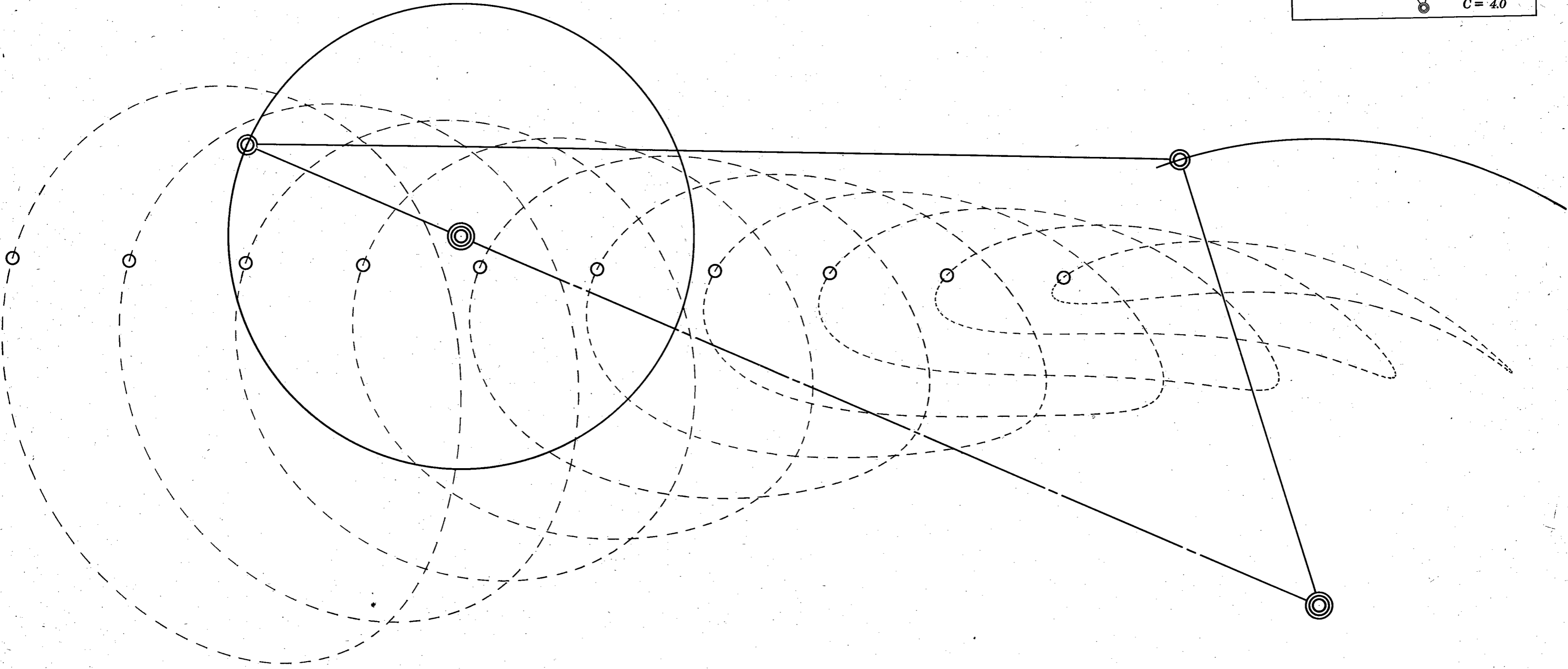
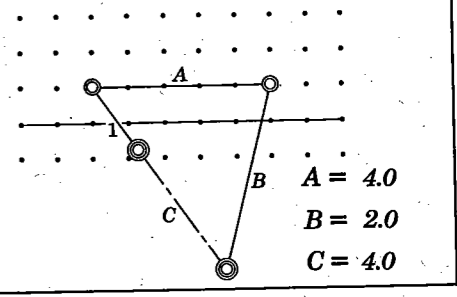

from  
Design of Machinery 4ed  
by Robert L. Norton  
McGraw-Hill  
Copyright 2008

**Analysis of the Four Bar Linkage**  
*J. A. Hrones and G. L. Nelson*

$A = 4.0$   
 $B = 2.0$   
 $C = 4.0$

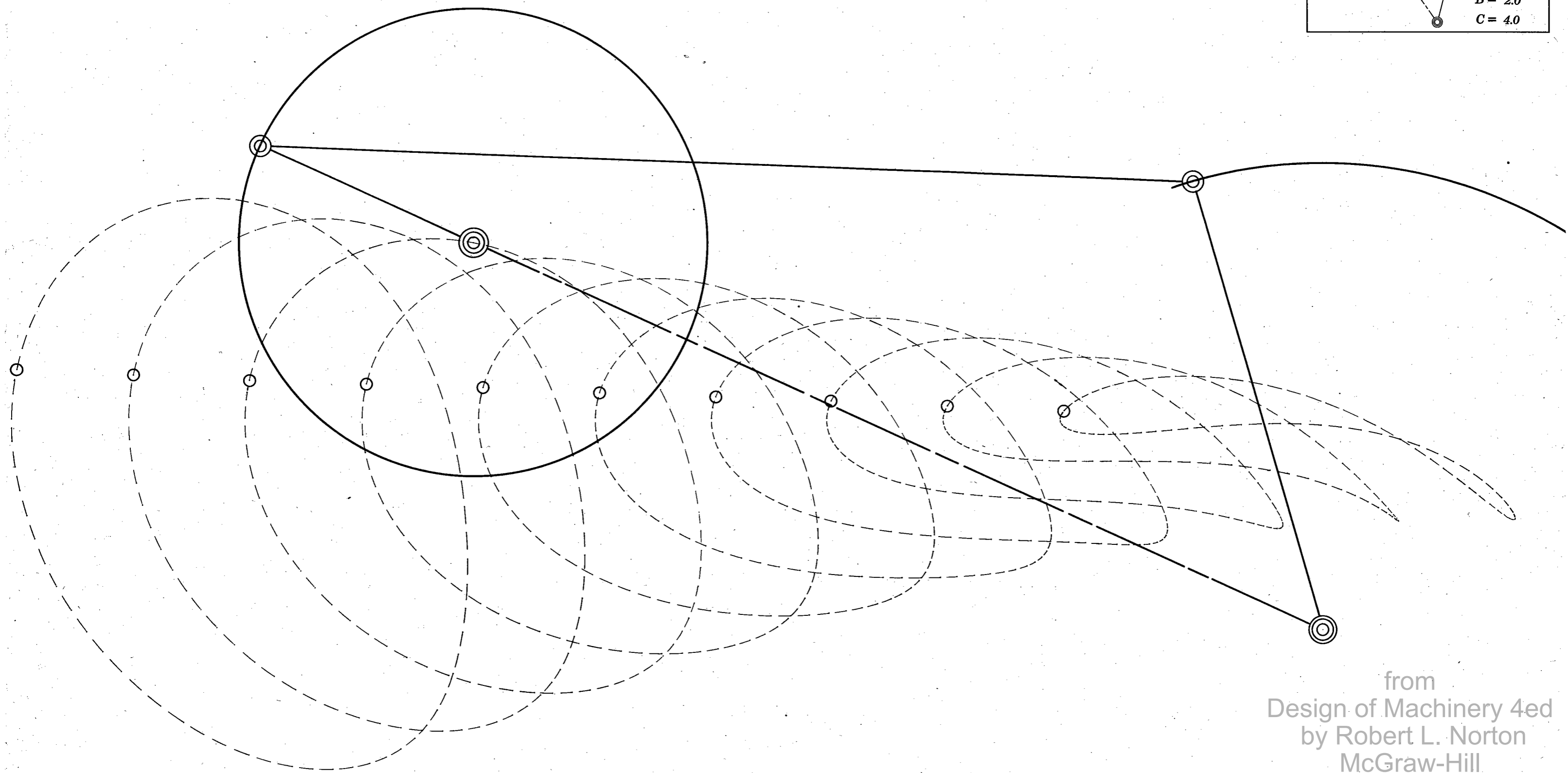

from  
 Design of Machinery 4ed  
 by Robert L. Norton  
 McGraw-Hill  
 Copyright 2008

**Analysis of the Four Bar Linkage**  
*J. A. Hrones and G. L. Nelson*

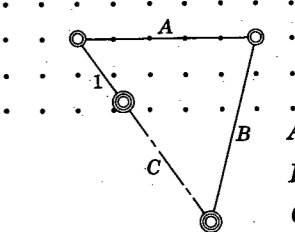

$A = 4.0$   
 $B = 2.0$   
 $C = 4.5$

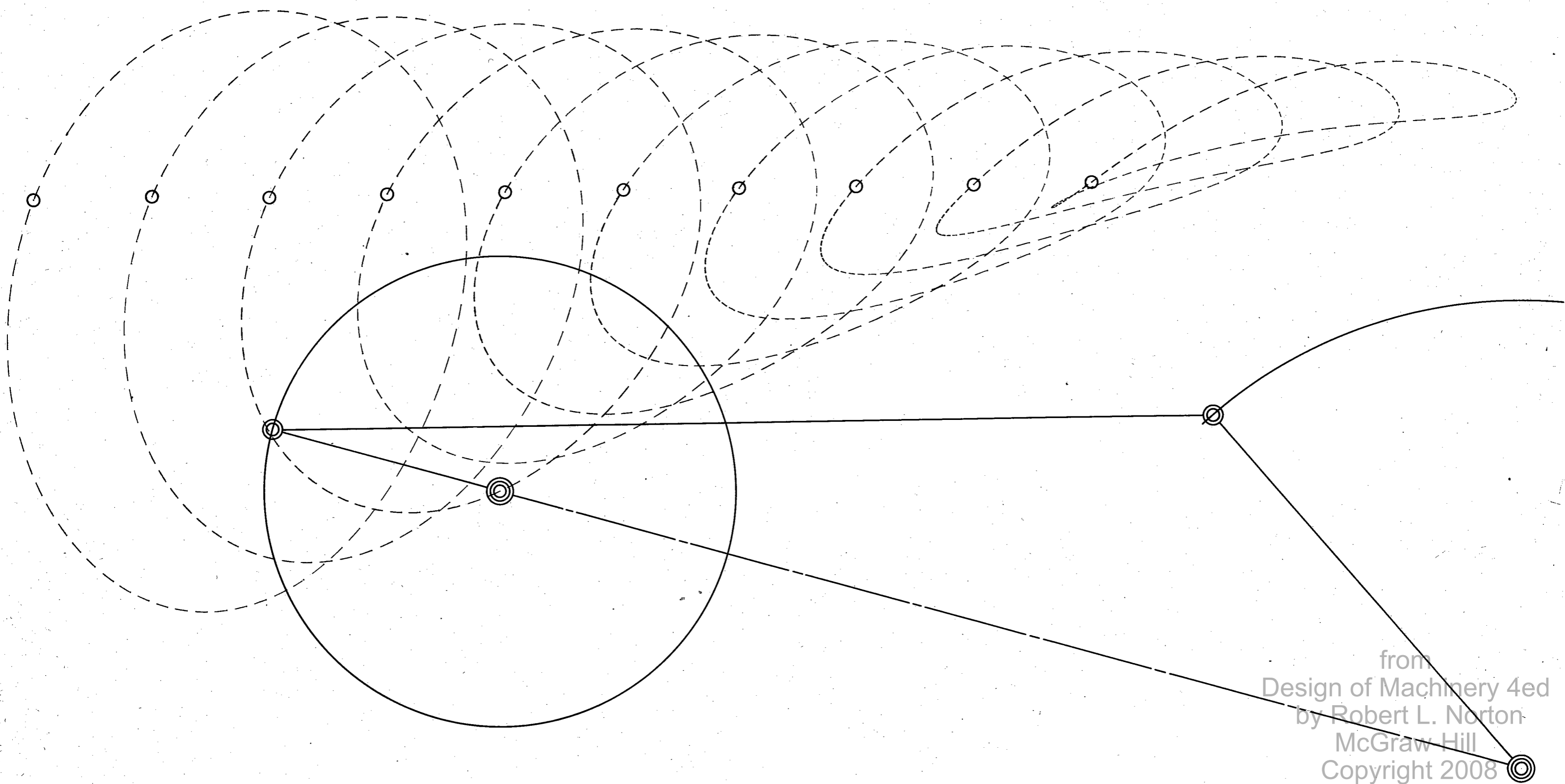

from  
Design of Machinery 4ed  
by Robert L. Norton  
McGraw Hill  
Copyright 2008

**Analysis of the Four Bar Linkage**

*J. A. Hrones and G. L. Nelson*

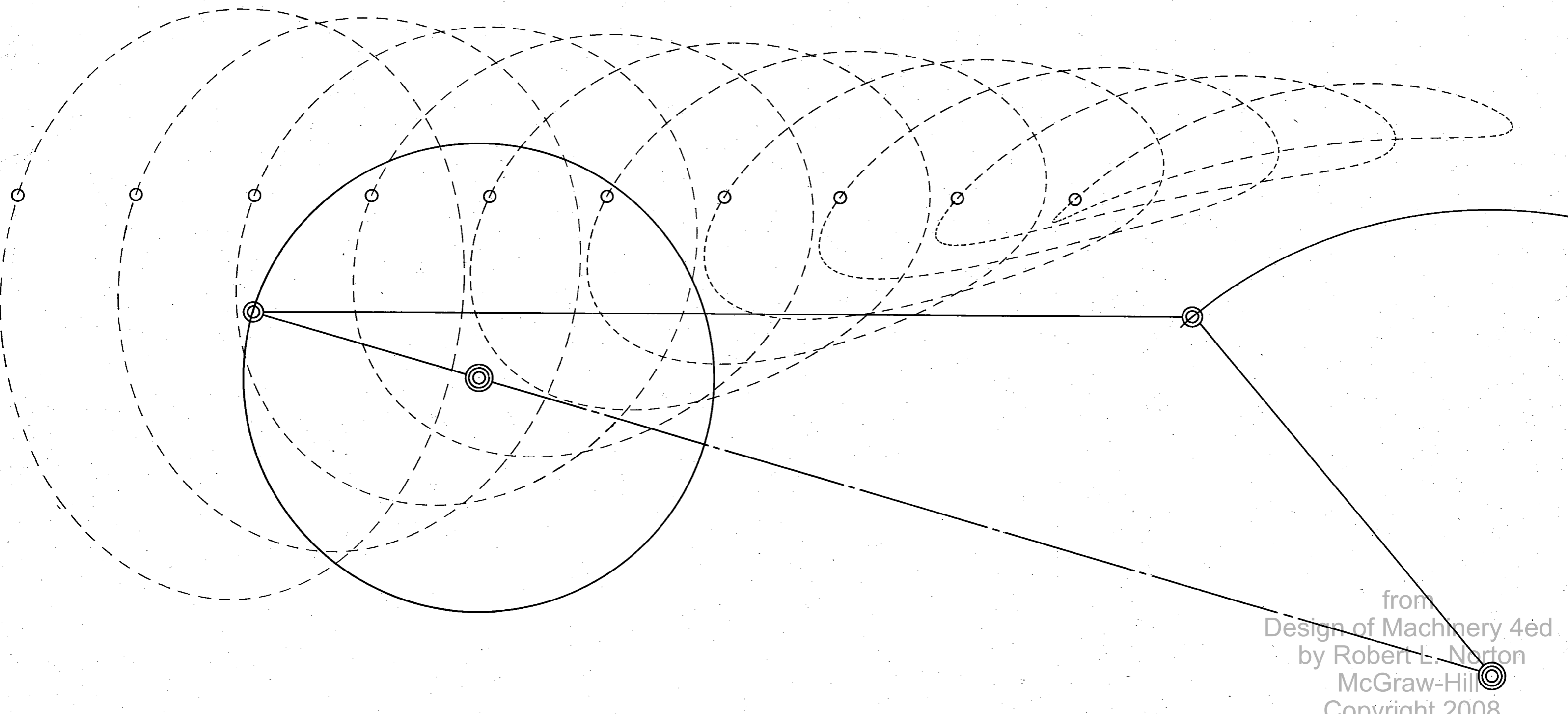
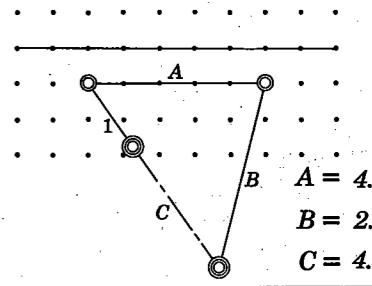

from  
Design of Machinery 4ed  
by Robert L. Norton  
McGraw-Hill  
Copyright 2008

**Analysis of the Four Bar Linkage**  
*J. A. Hrones and G. L. Nelson*

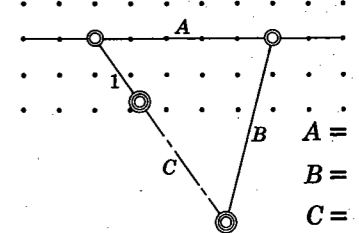

$A = 4.0$   
 $B = 2.0$   
 $C = 4.5$

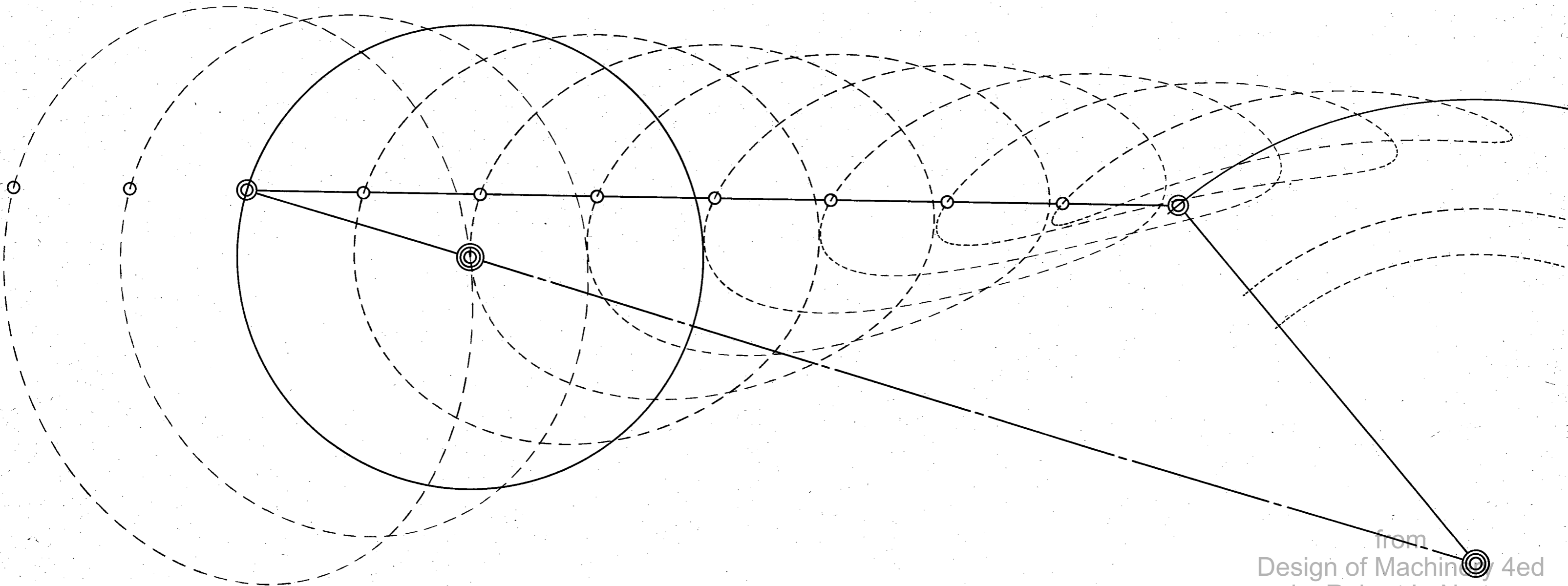

from  
Design of Machinery 4ed  
by Robert L. Norton  
McGraw-Hill  
Copyright 2008

**Analysis of the Four Bar Linkage**  
*J. A. Hrones and G. L. Nelson*

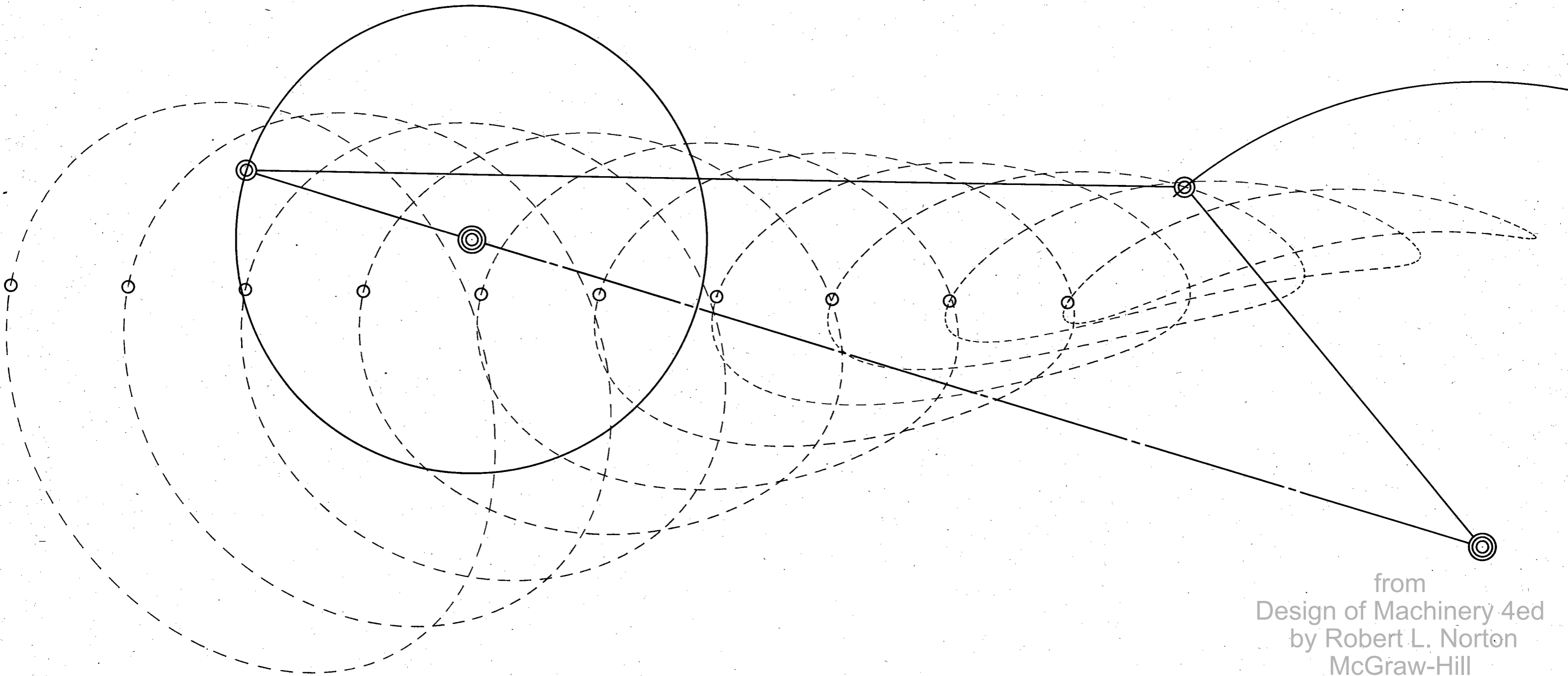
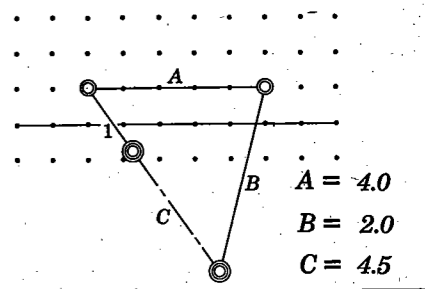

from  
Design of Machinery 4ed  
by Robert L. Norton  
McGraw-Hill  
Copyright 2008

**Analysis of the Four Bar Linkage**  
*J. A. Hrones and G. L. Nelson*

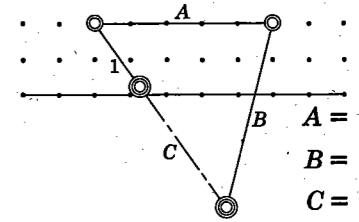

$A = 4.0$   
 $B = 2.0$   
 $C = 4.5$

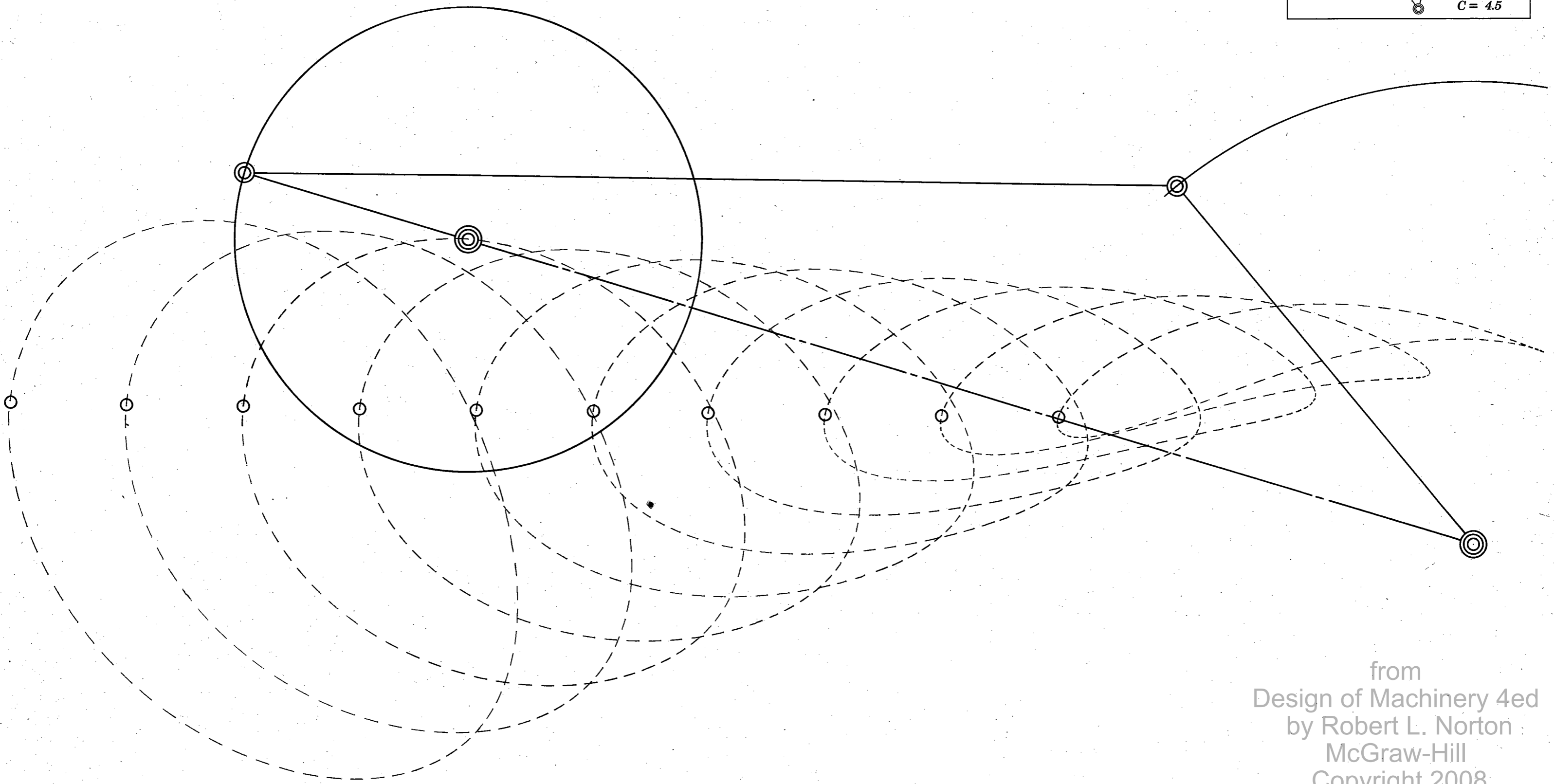

from  
Design of Machinery 4ed  
by Robert L. Norton  
McGraw-Hill  
Copyright 2008

**Analysis of the Four Bar Linkage**

*J. A. Hrones and G. L. Nelson*

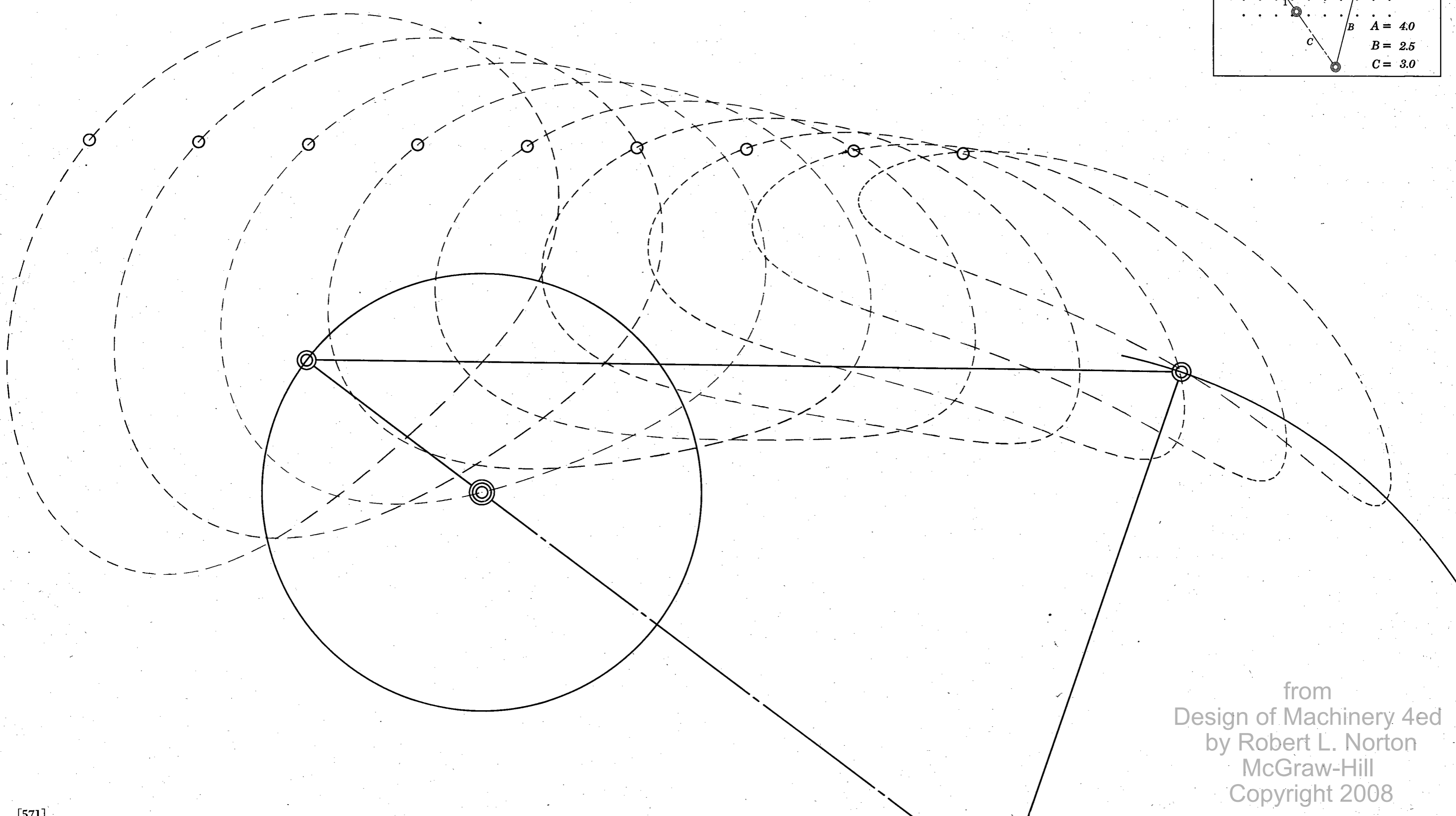
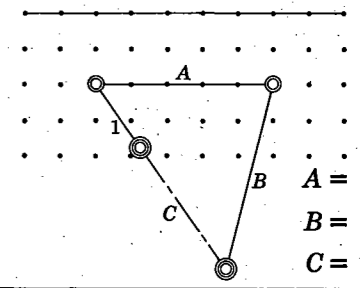

from  
Design of Machinery 4ed  
by Robert L. Norton  
McGraw-Hill  
Copyright 2008



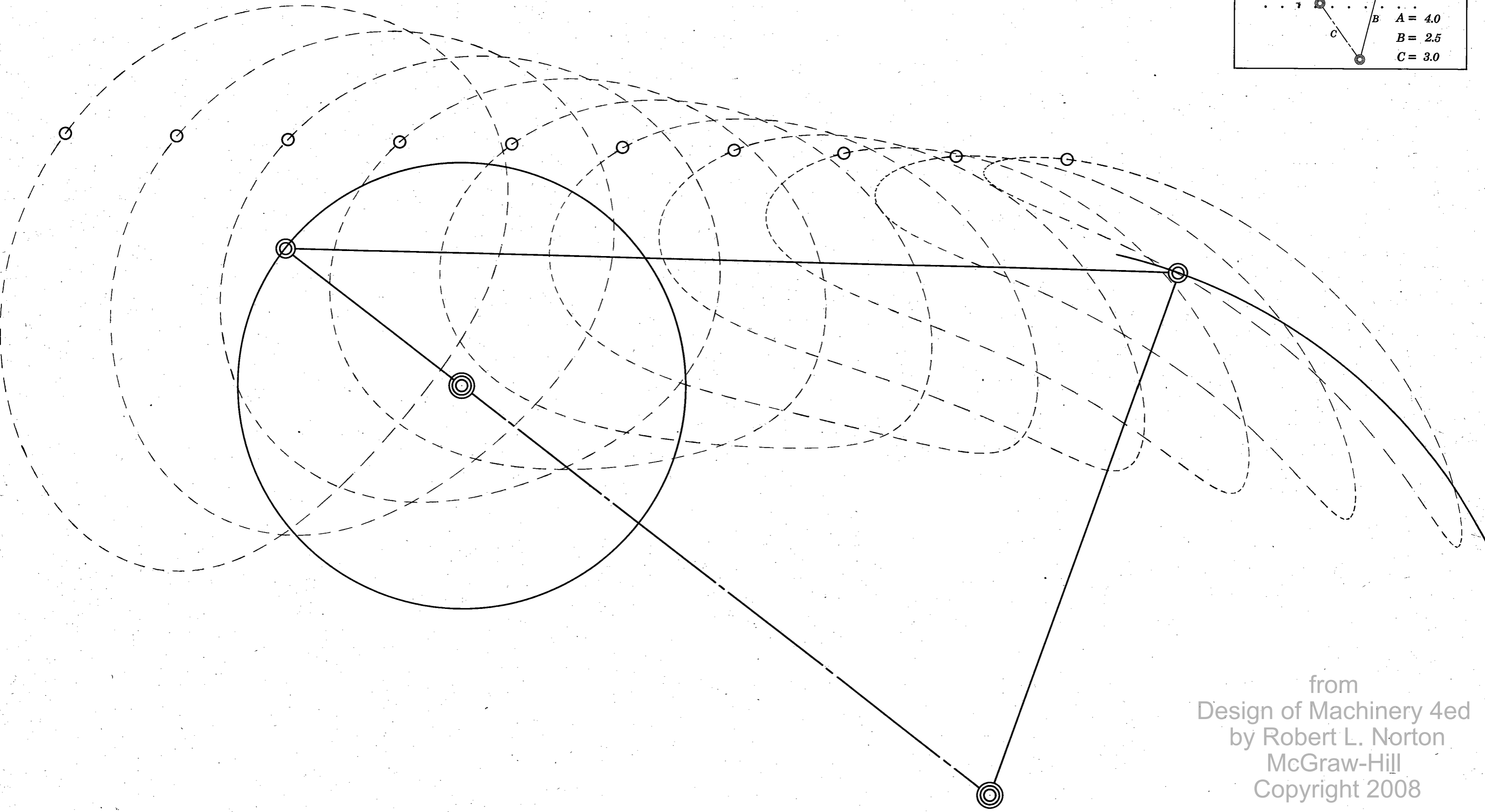
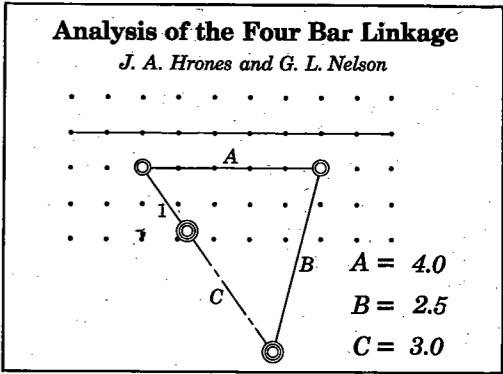

from  
Design of Machinery 4ed  
by Robert L. Norton  
McGraw-Hill  
Copyright 2008

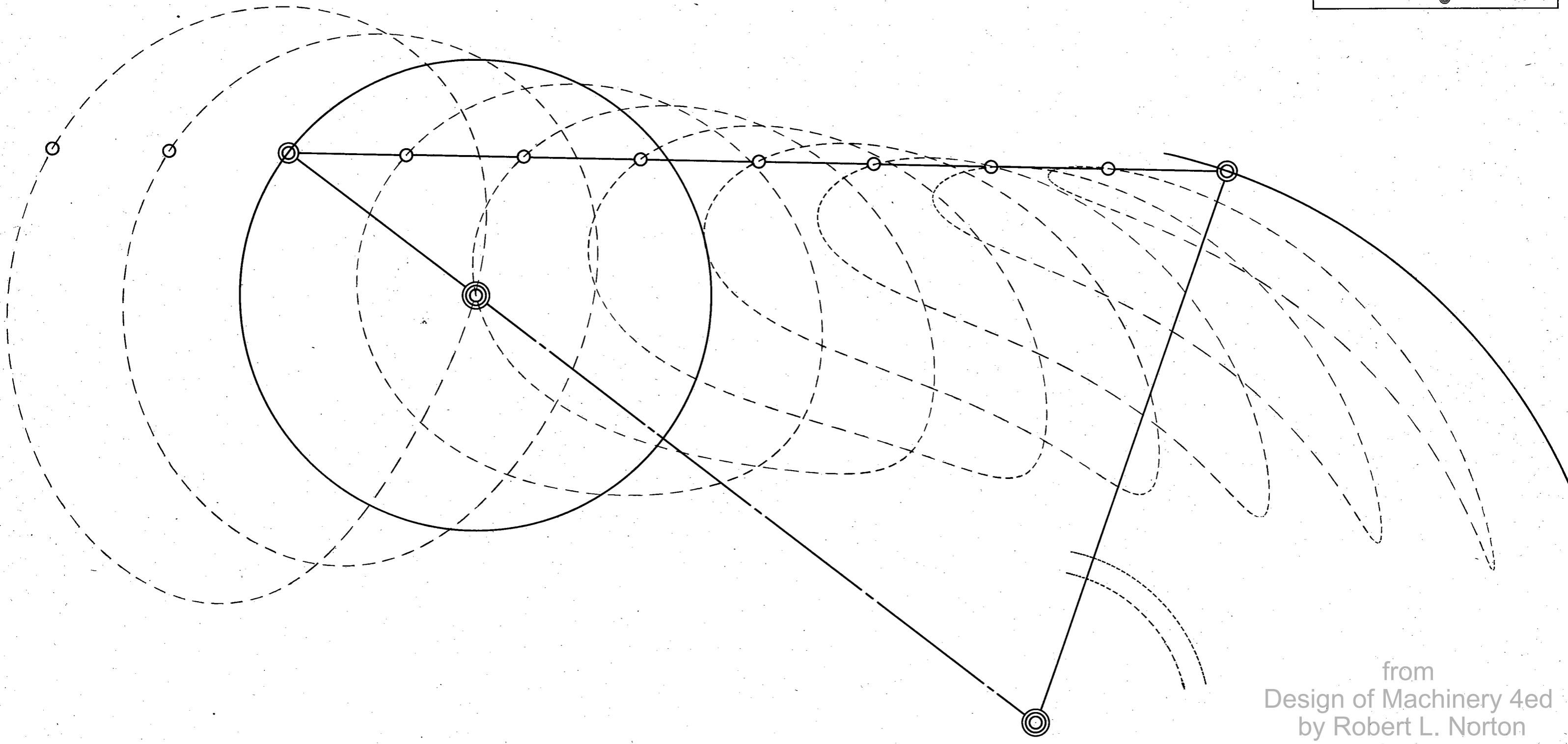
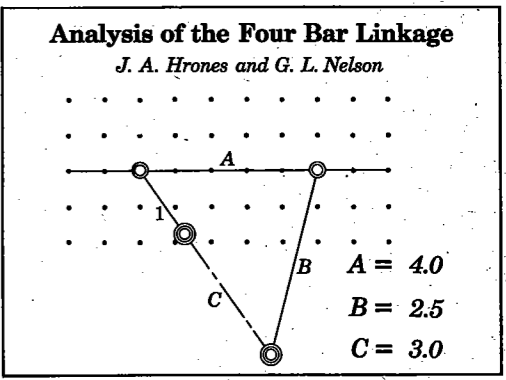

from  
 Design of Machinery 4ed  
 by Robert L. Norton  
 McGraw-Hill  
 Copyright 2008

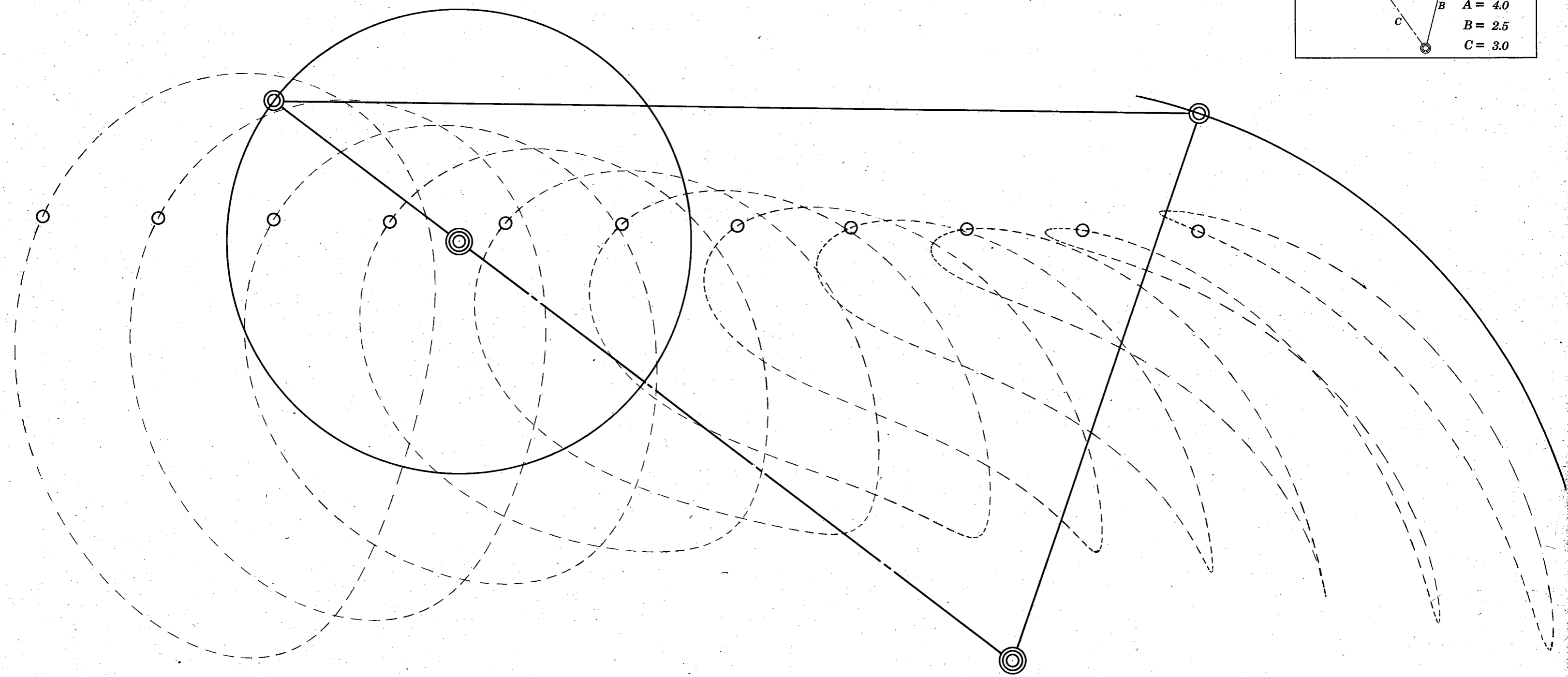
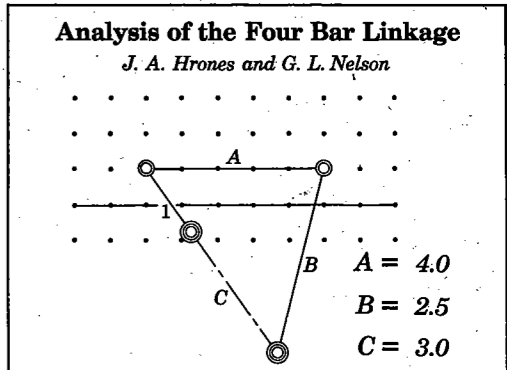

from  
Design of Machinery 4ed  
by Robert L. Norton  
McGraw-Hill  
Copyright 2008

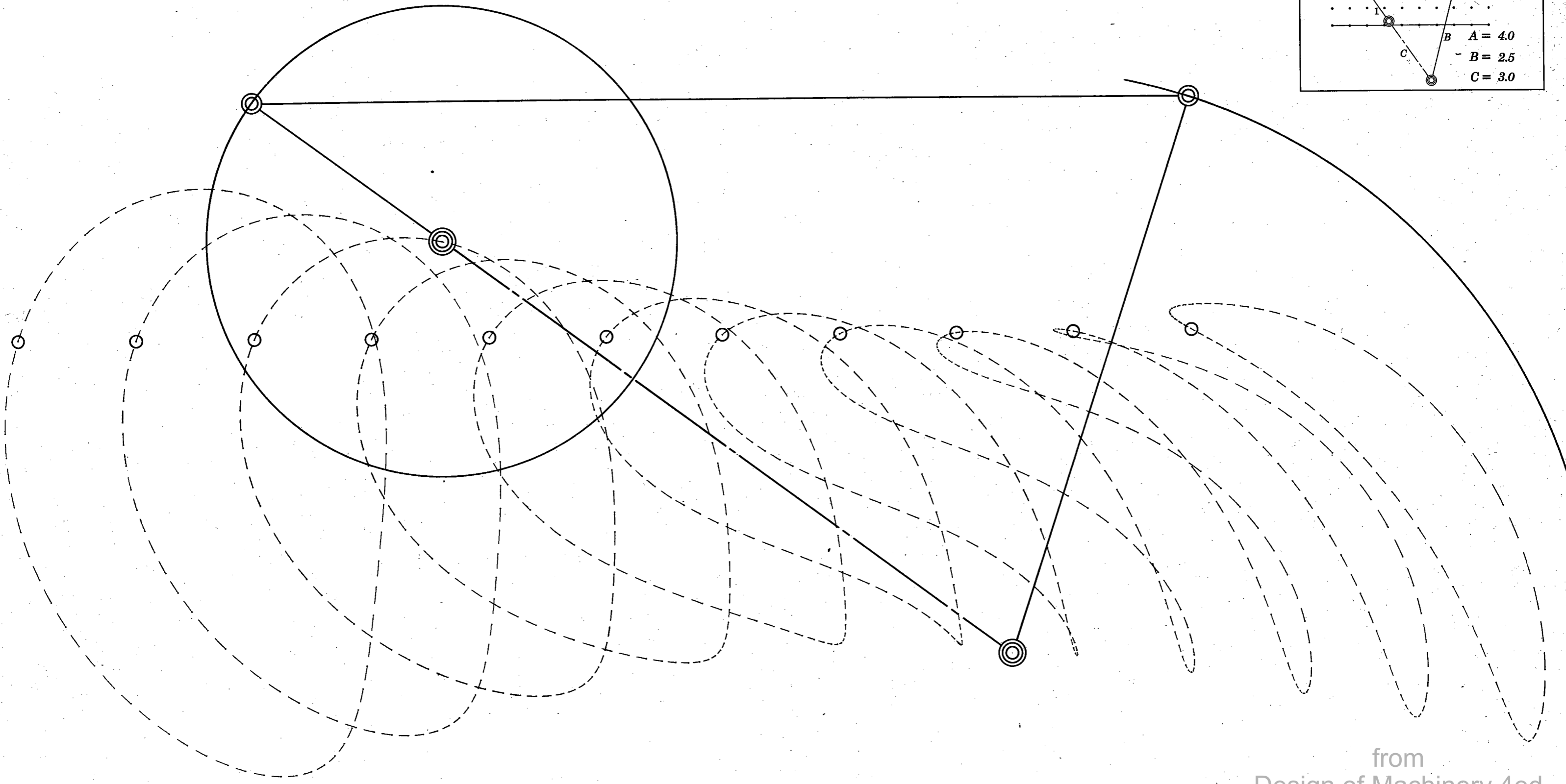
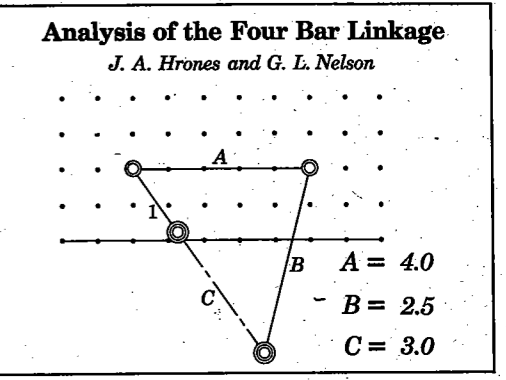

from  
 Design of Machinery 4ed  
 by Robert L. Norton  
 McGraw-Hill  
 Copyright 2008

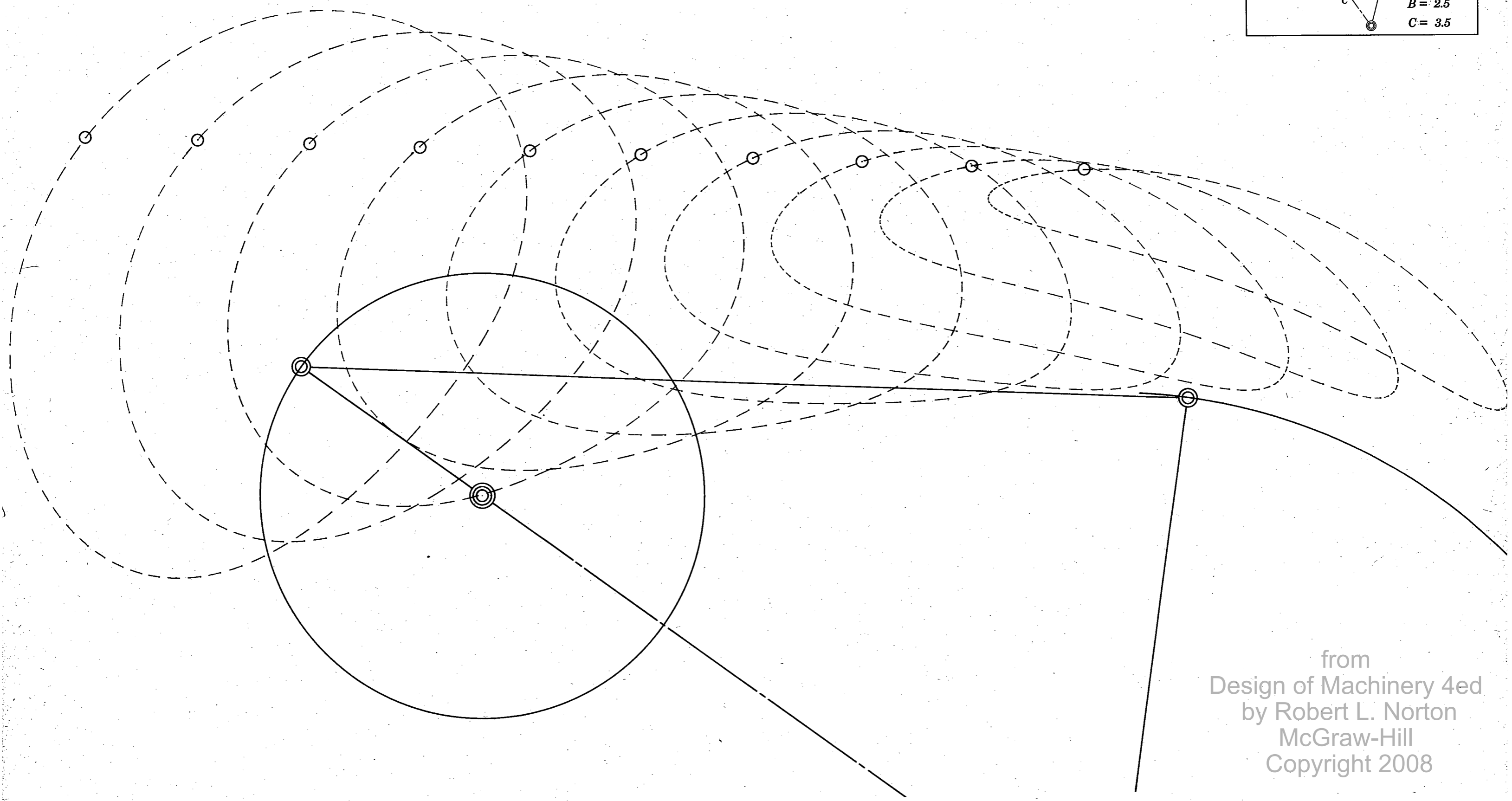
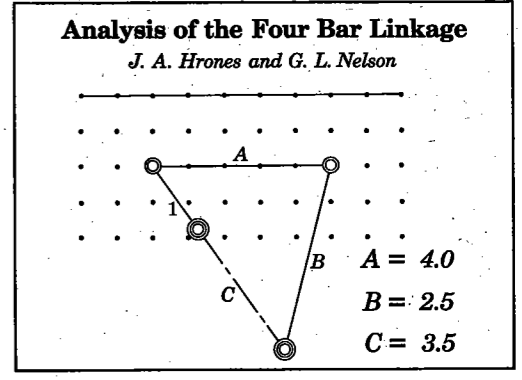

from  
Design of Machinery 4ed  
by Robert L. Norton  
McGraw-Hill  
Copyright 2008

**Analysis of the Four Bar Linkage**

*J. A. Hrones and G. L. Nelson*

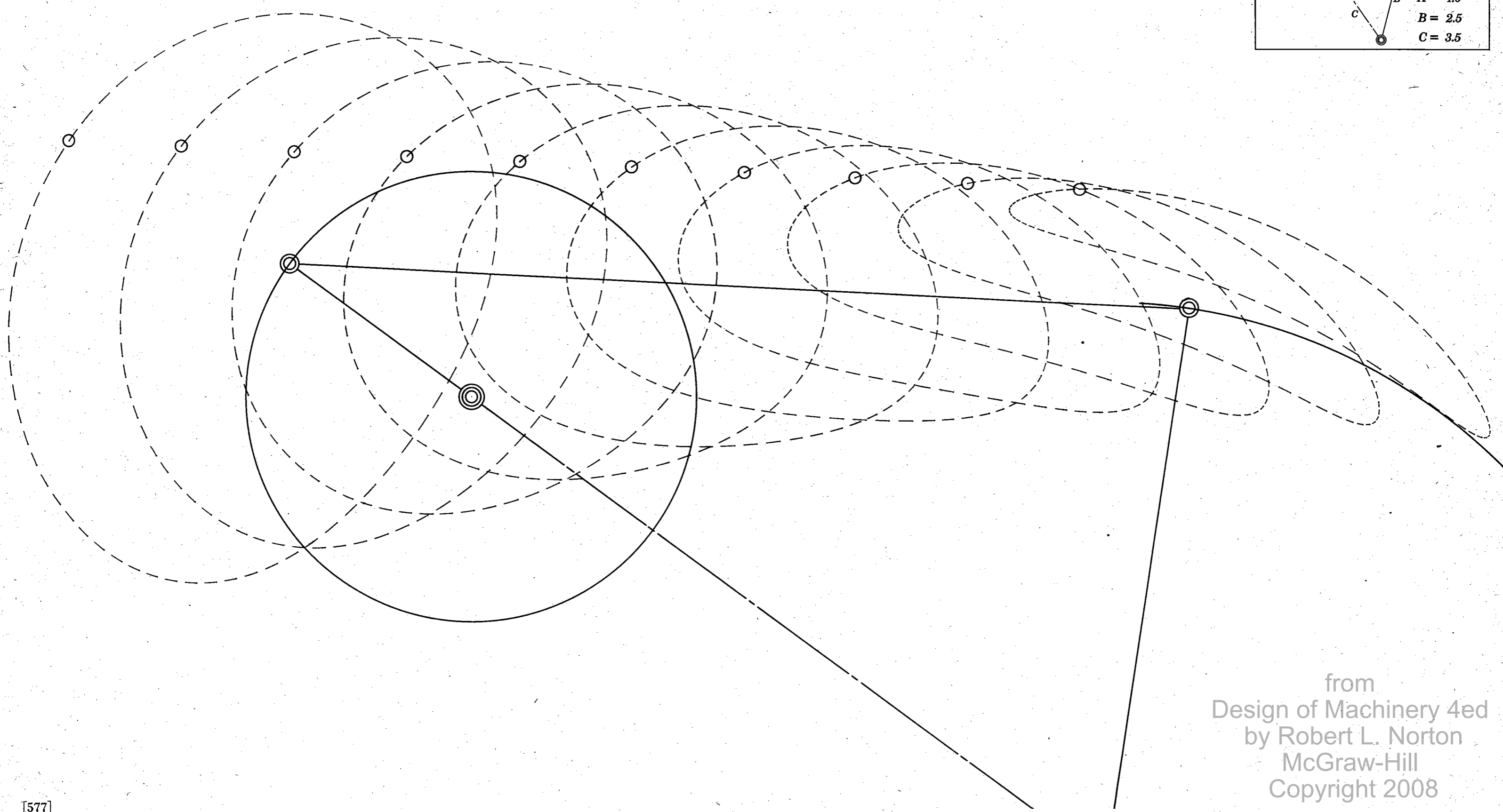
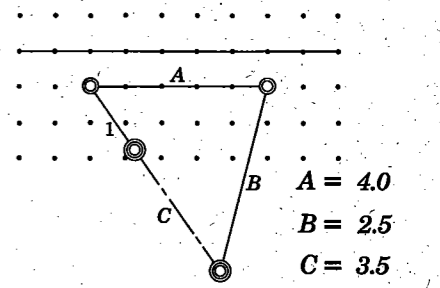

from  
Design of Machinery 4ed  
by Robert L. Norton  
McGraw-Hill  
Copyright 2008

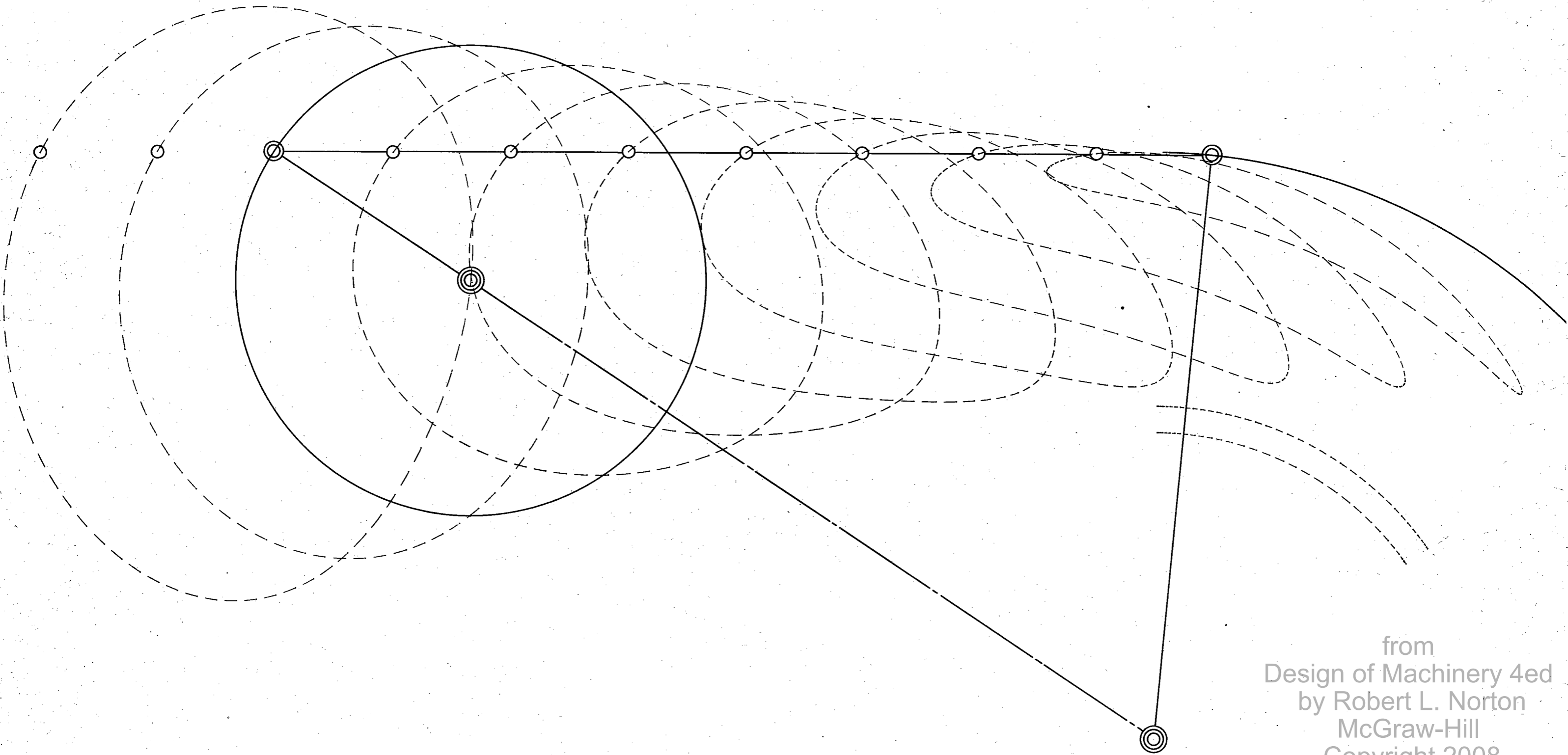
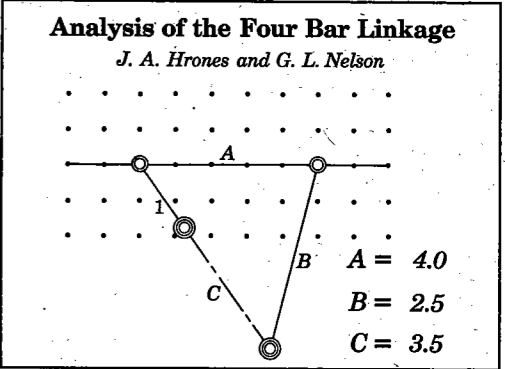

from  
Design of Machinery 4ed  
by Robert L. Norton  
McGraw-Hill  
Copyright 2008

**Analysis of the Four Bar Linkage**

*J. A. Hrones and G. L. Nelson*

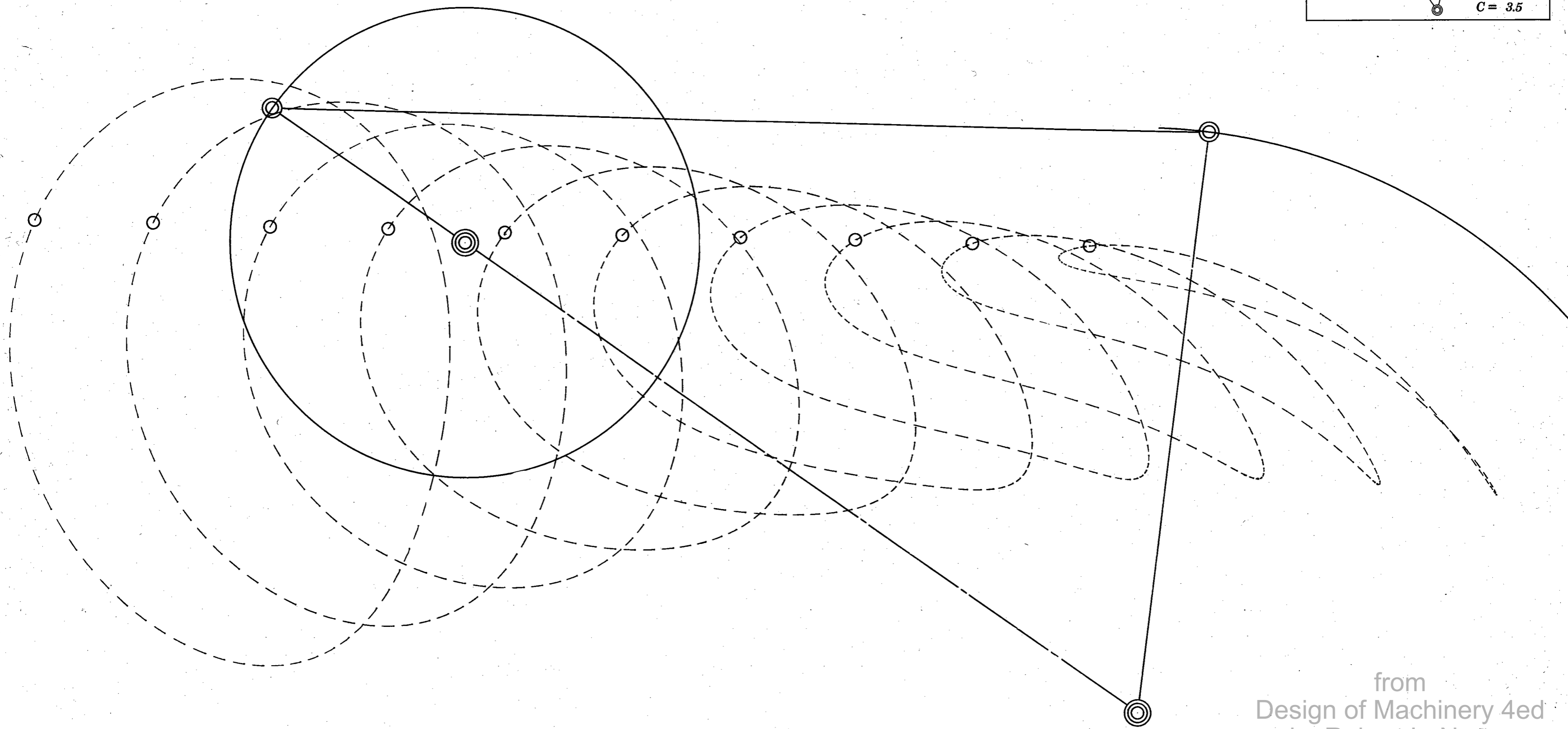
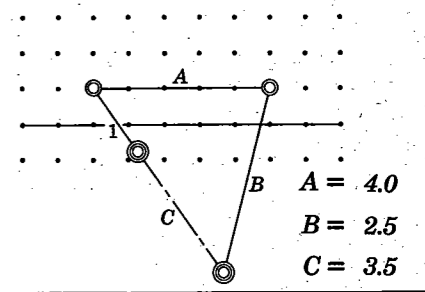

from  
Design of Machinery 4ed  
by Robert L. Norton  
McGraw-Hill  
Copyright 2008



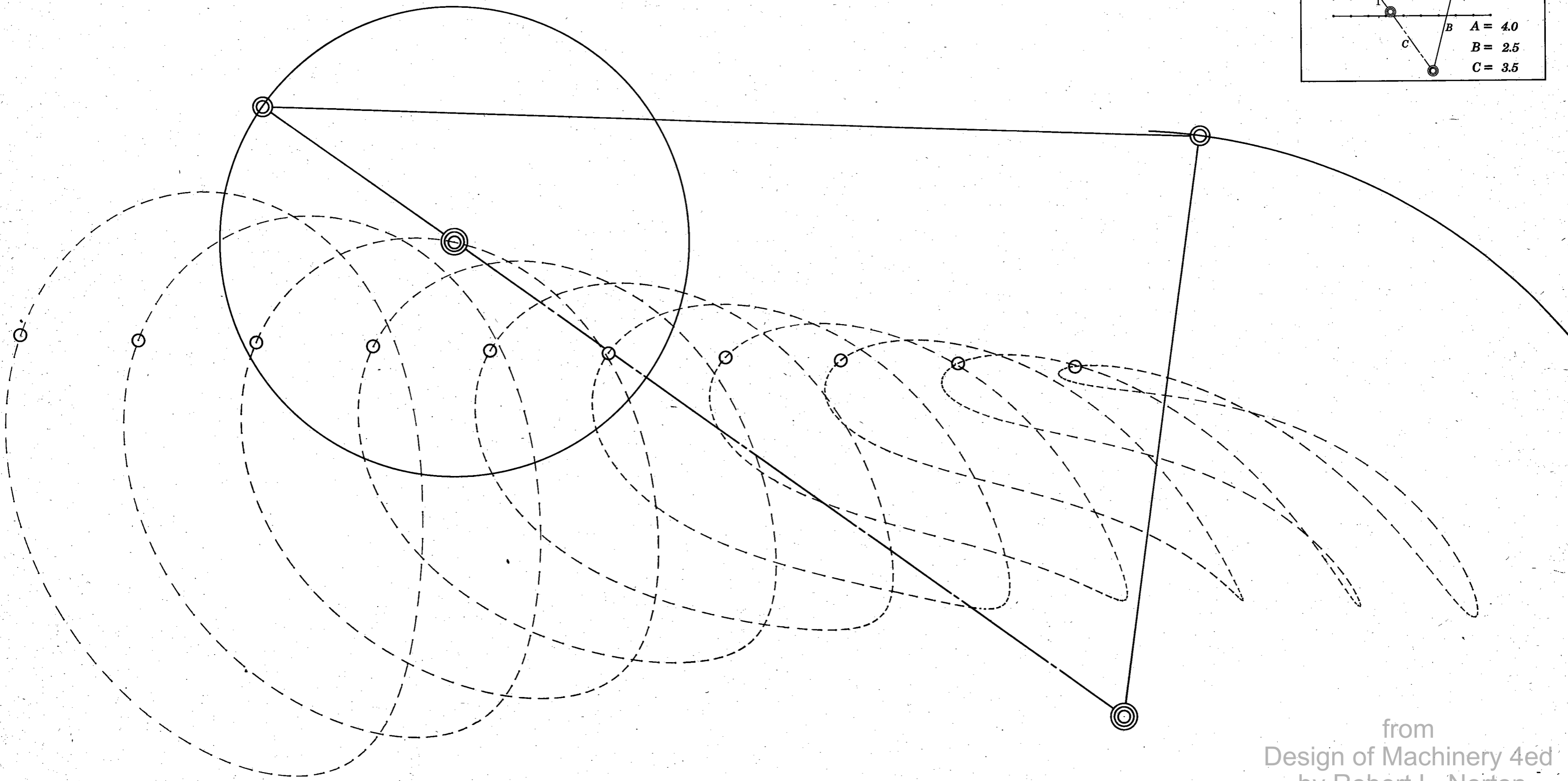
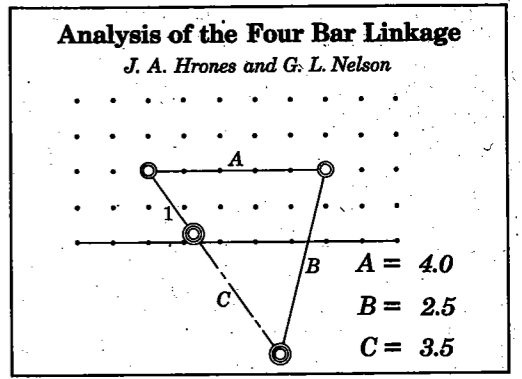

from  
Design of Machinery 4ed  
by Robert L. Norton  
McGraw-Hill  
Copyright 2008

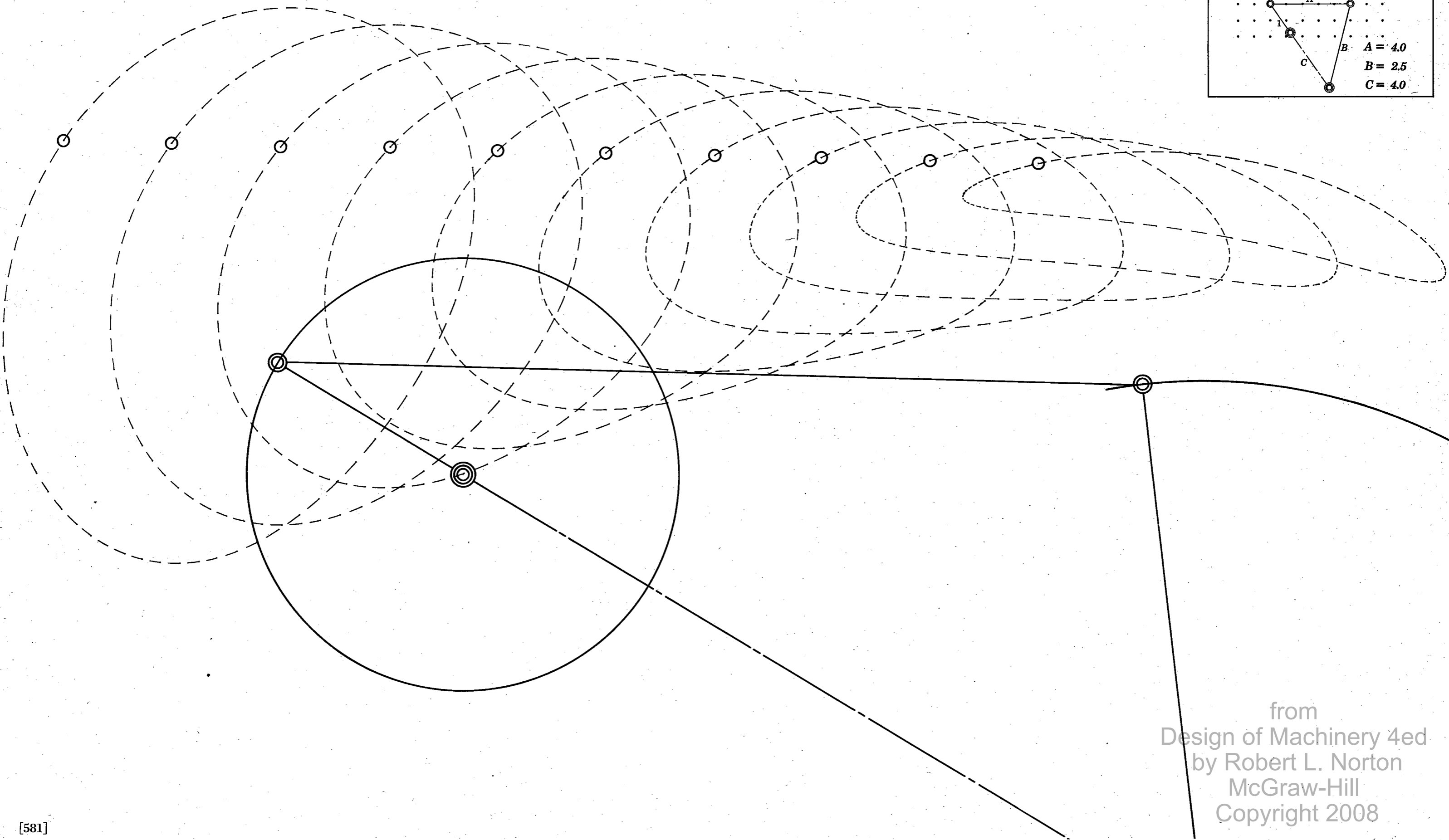
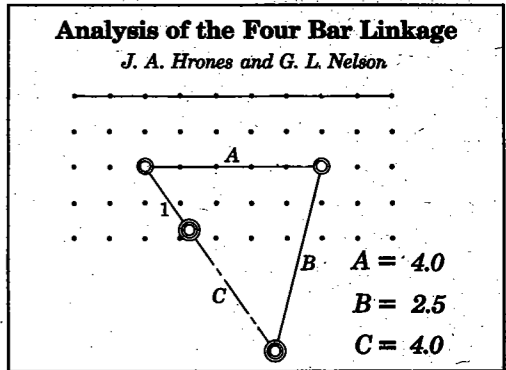

from  
 Design of Machinery 4ed  
 by Robert L. Norton  
 McGraw-Hill  
 Copyright 2008

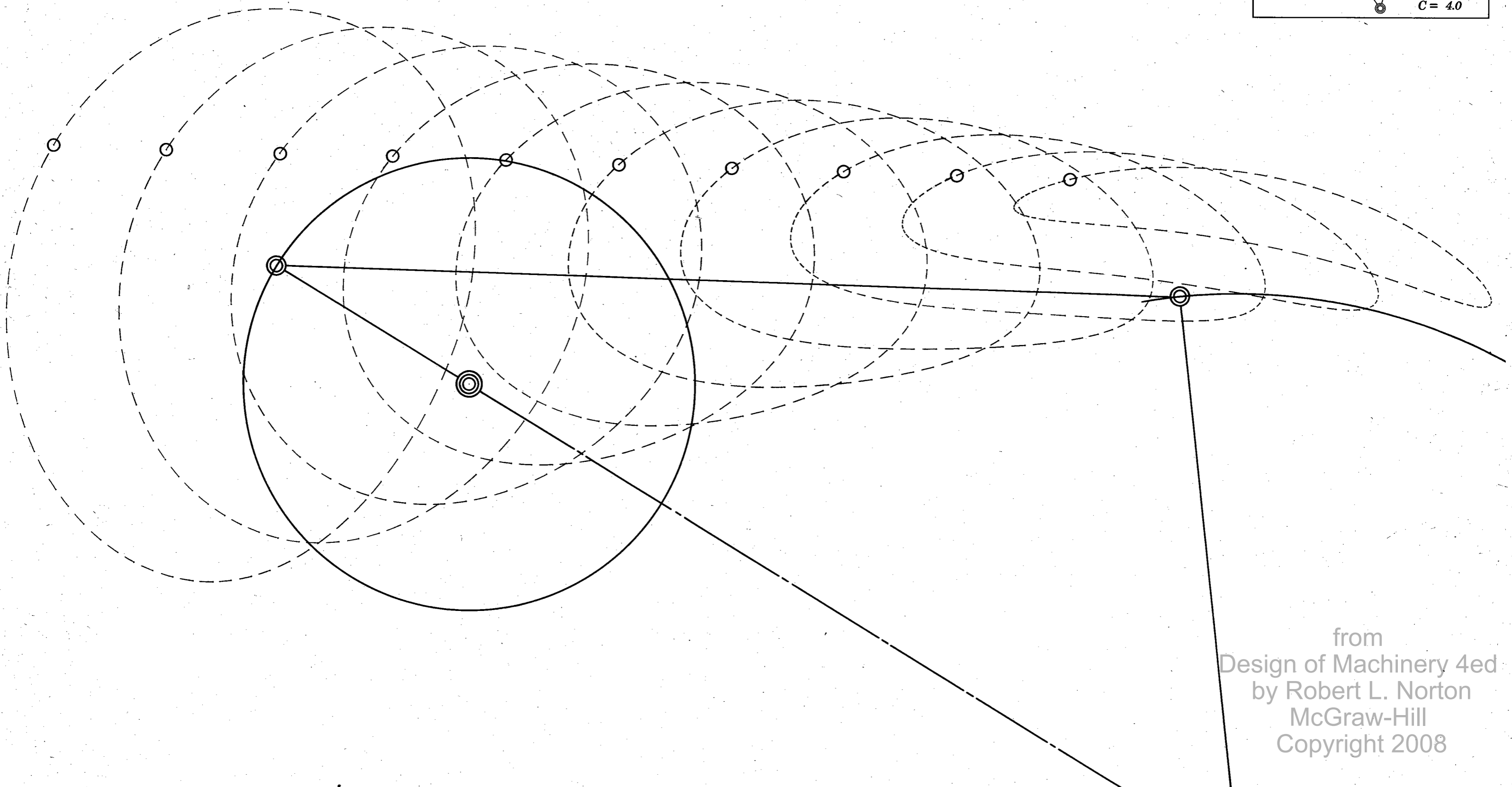
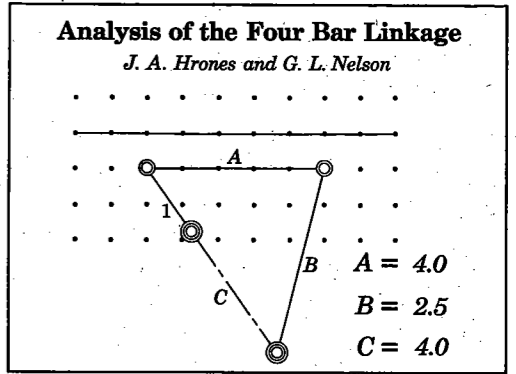

from  
Design of Machinery 4ed  
by Robert L. Norton  
McGraw-Hill  
Copyright 2008

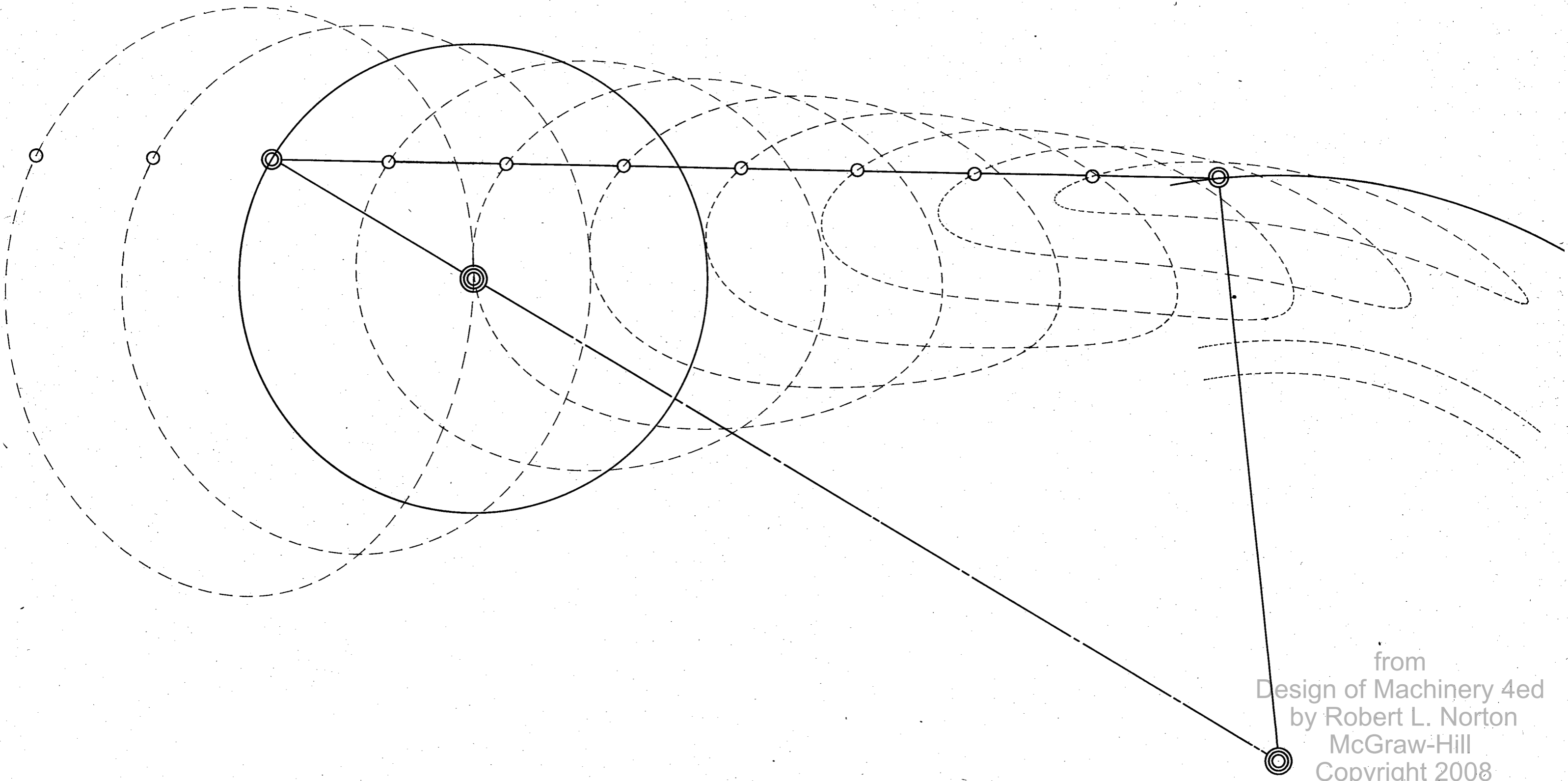
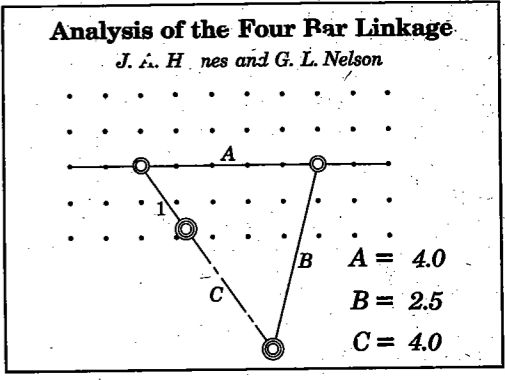

from  
 Design of Machinery 4ed  
 by Robert L. Norton  
 McGraw-Hill  
 Copyright 2008

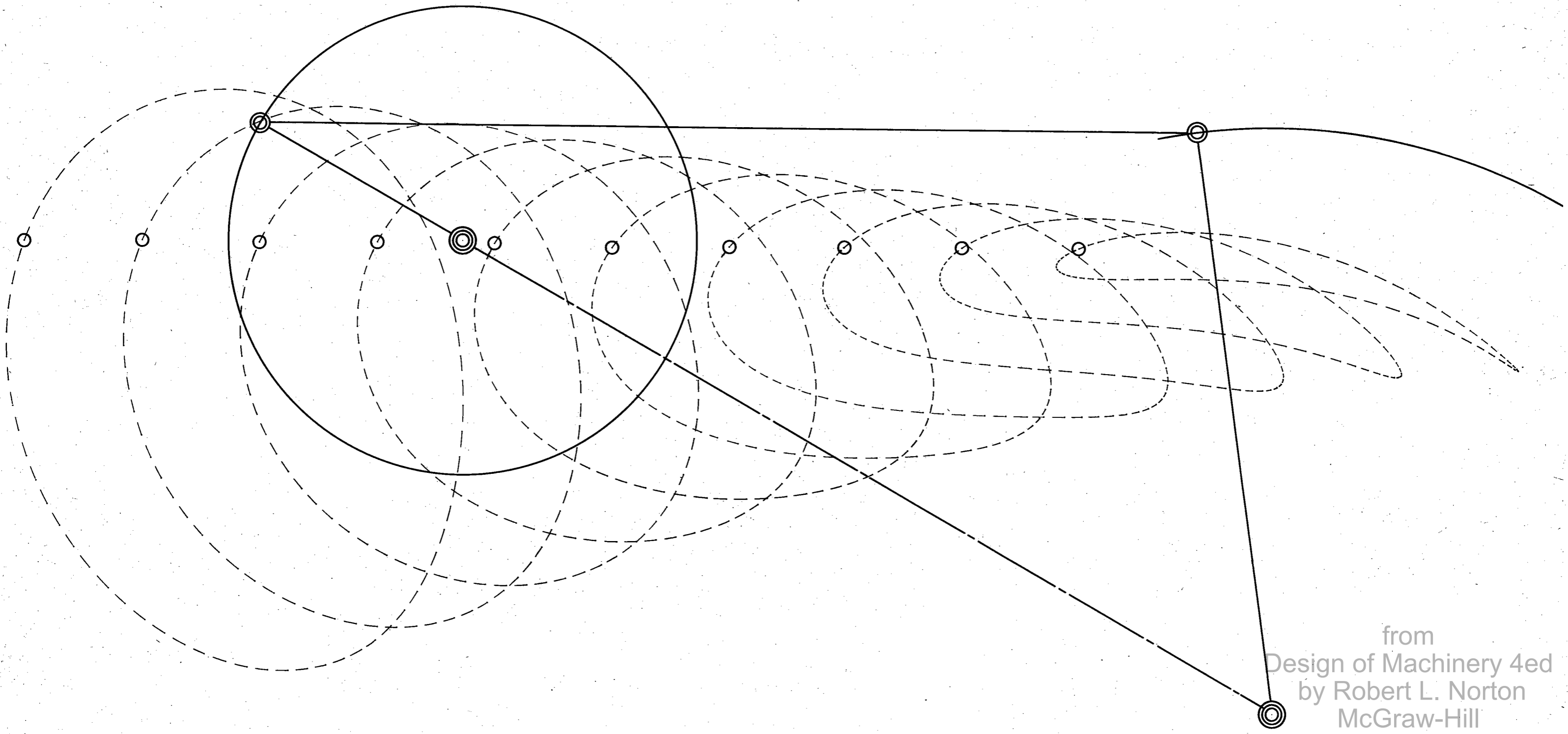
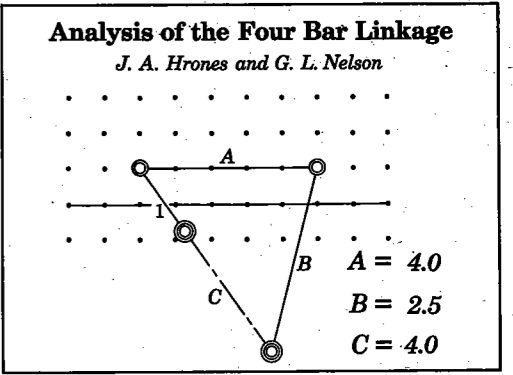

from  
Design of Machinery 4ed  
by Robert L. Norton  
McGraw-Hill  
Copyright 2008

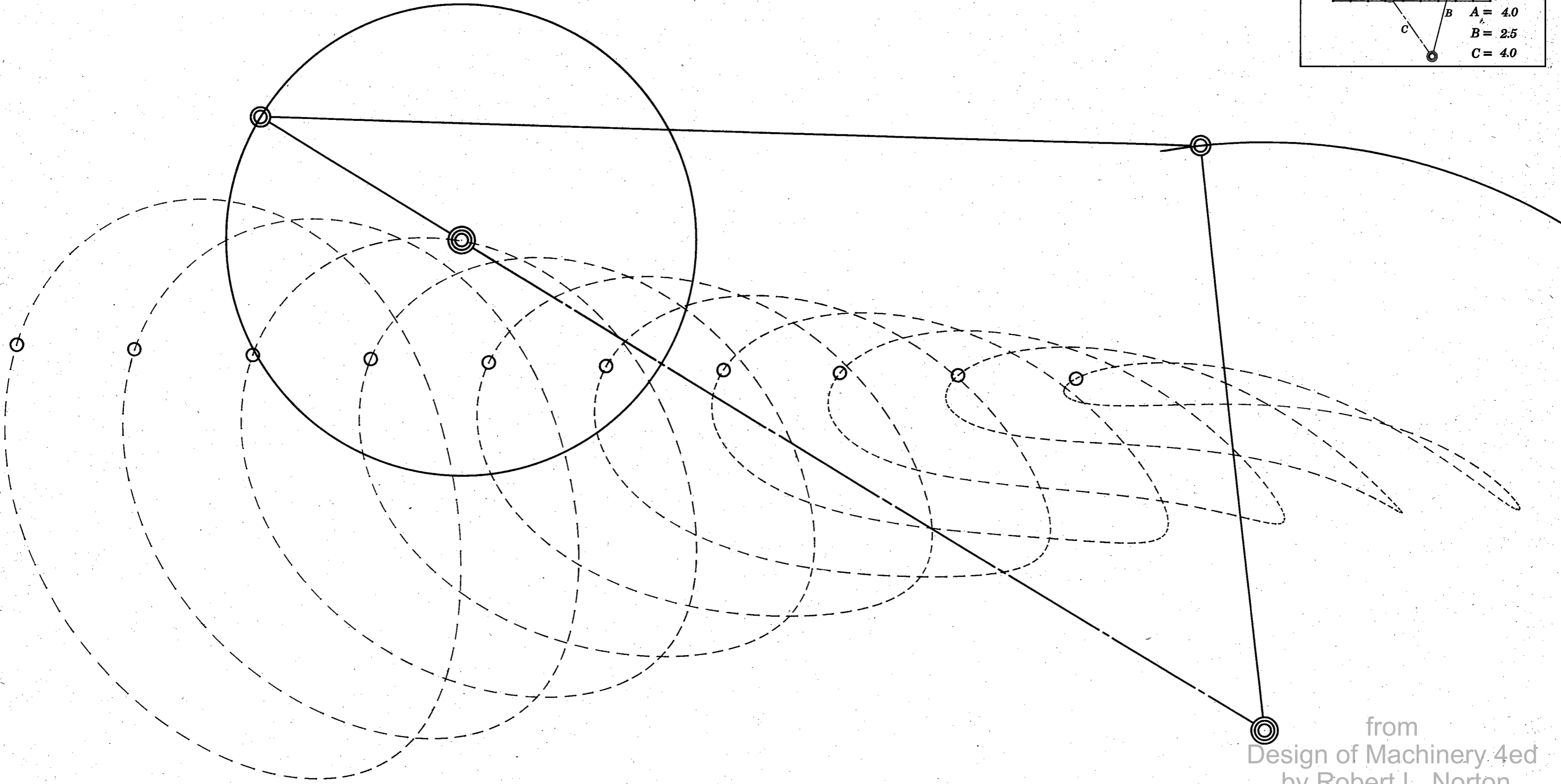
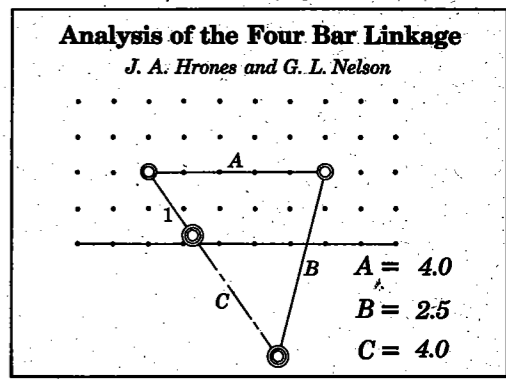

from  
 Design of Machinery, 4ed  
 by Robert L. Norton  
 McGraw-Hill  
 Copyright 2008

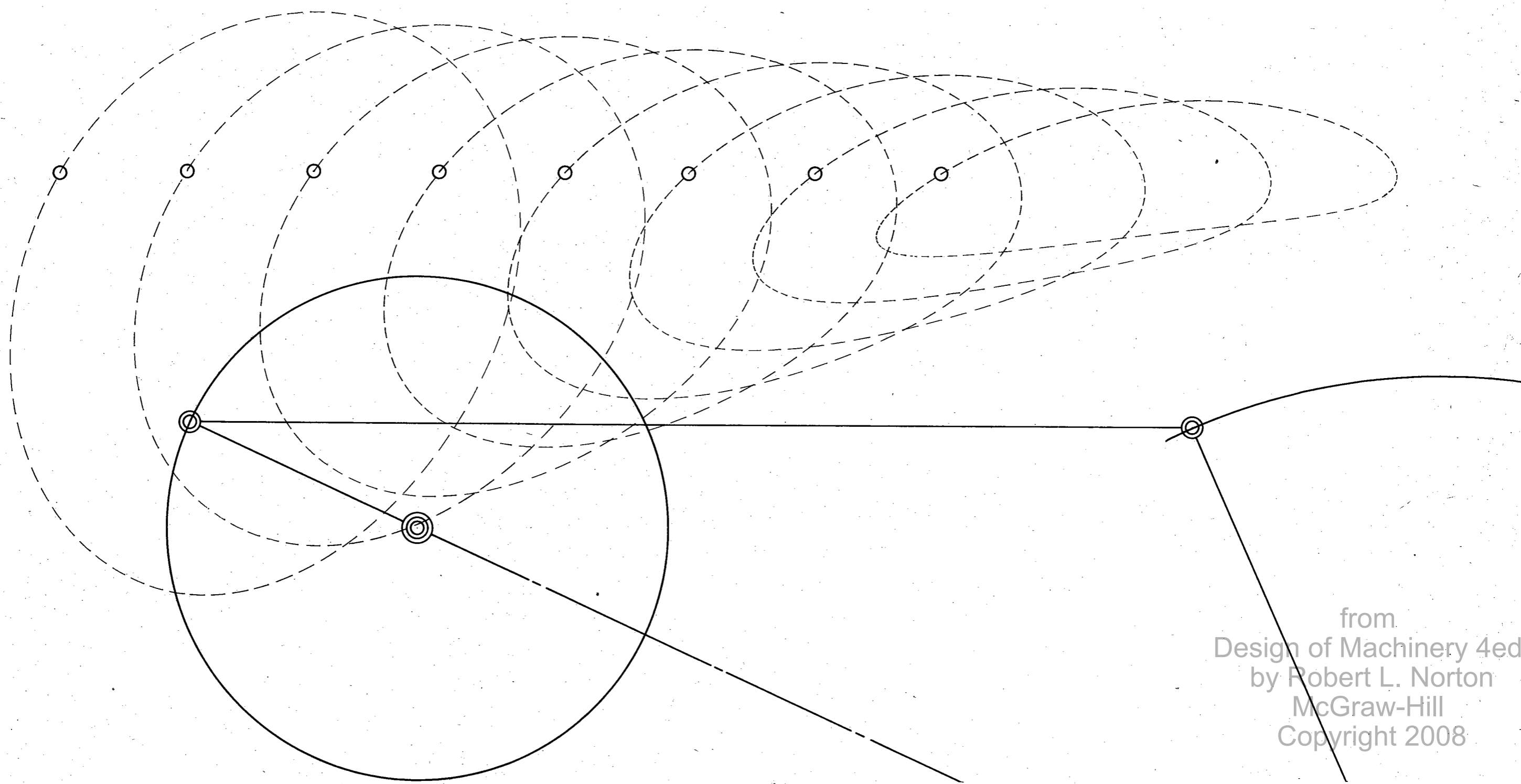
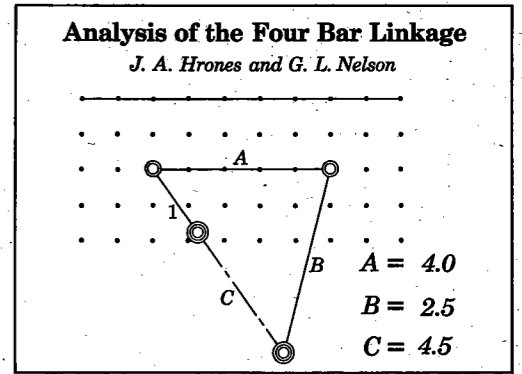

from  
Design of Machinery 4ed  
by Robert L. Norton  
McGraw-Hill  
Copyright 2008

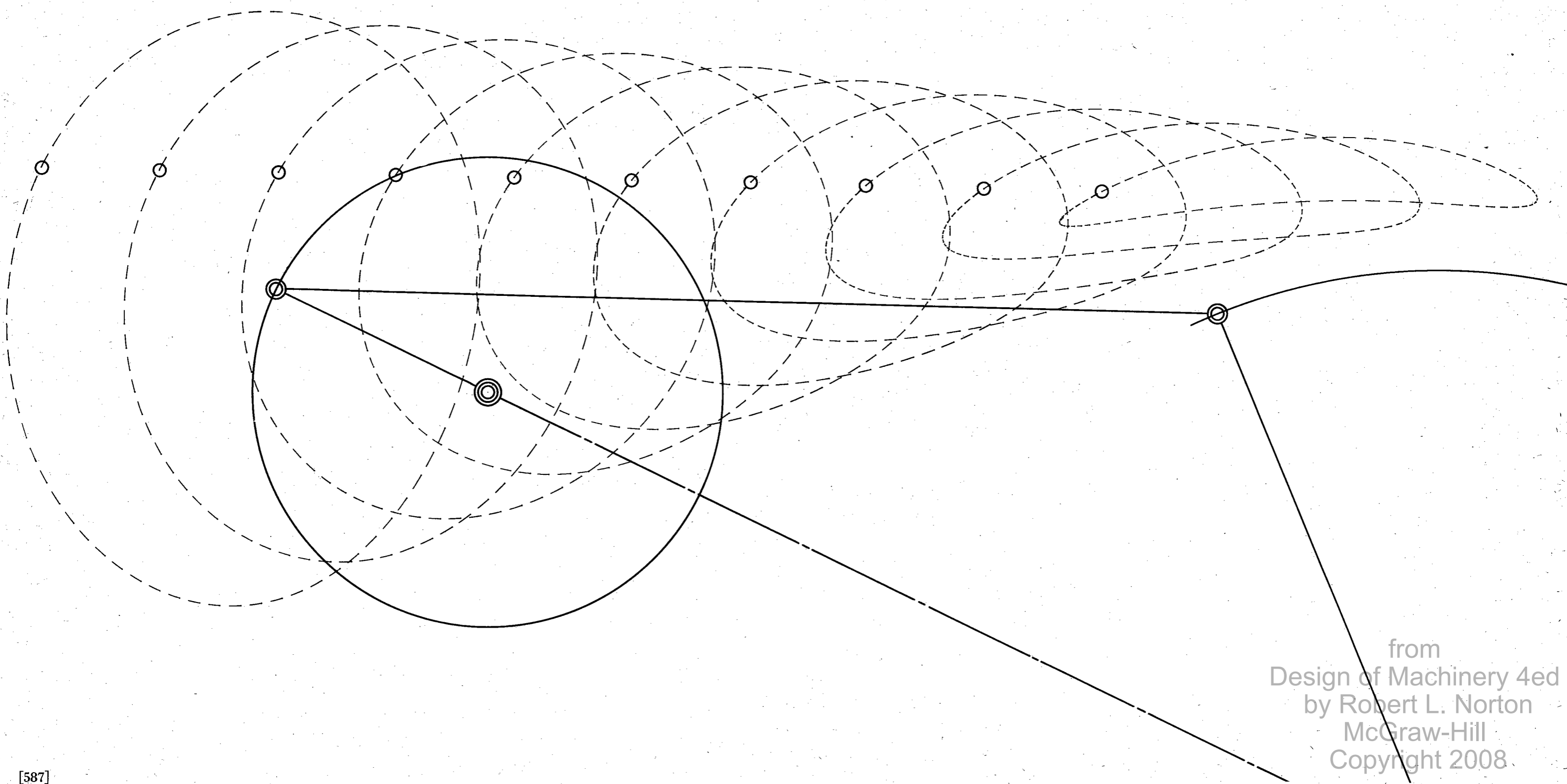
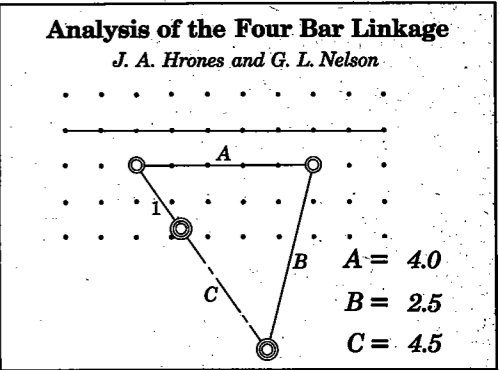

from  
 Design of Machinery 4ed  
 by Robert L. Norton  
 McGraw-Hill  
 Copyright 2008



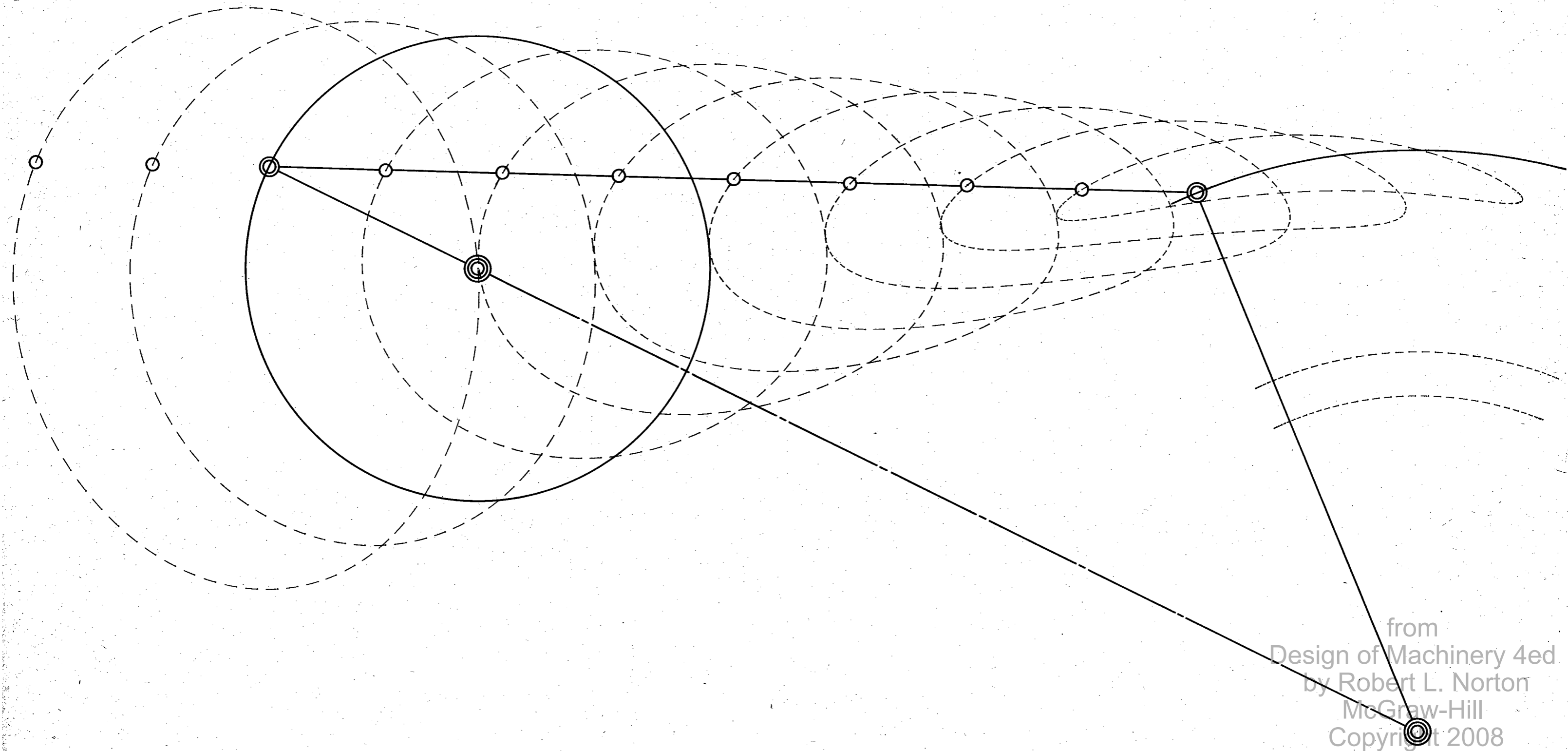
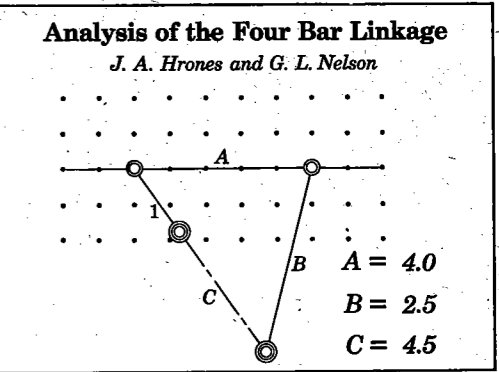

from  
Design of Machinery 4ed  
by Robert L. Norton  
McGraw-Hill  
Copyright 2008

**Analysis of the Four Bar Linkage**

*J. A. Hrones and G. L. Nelson*

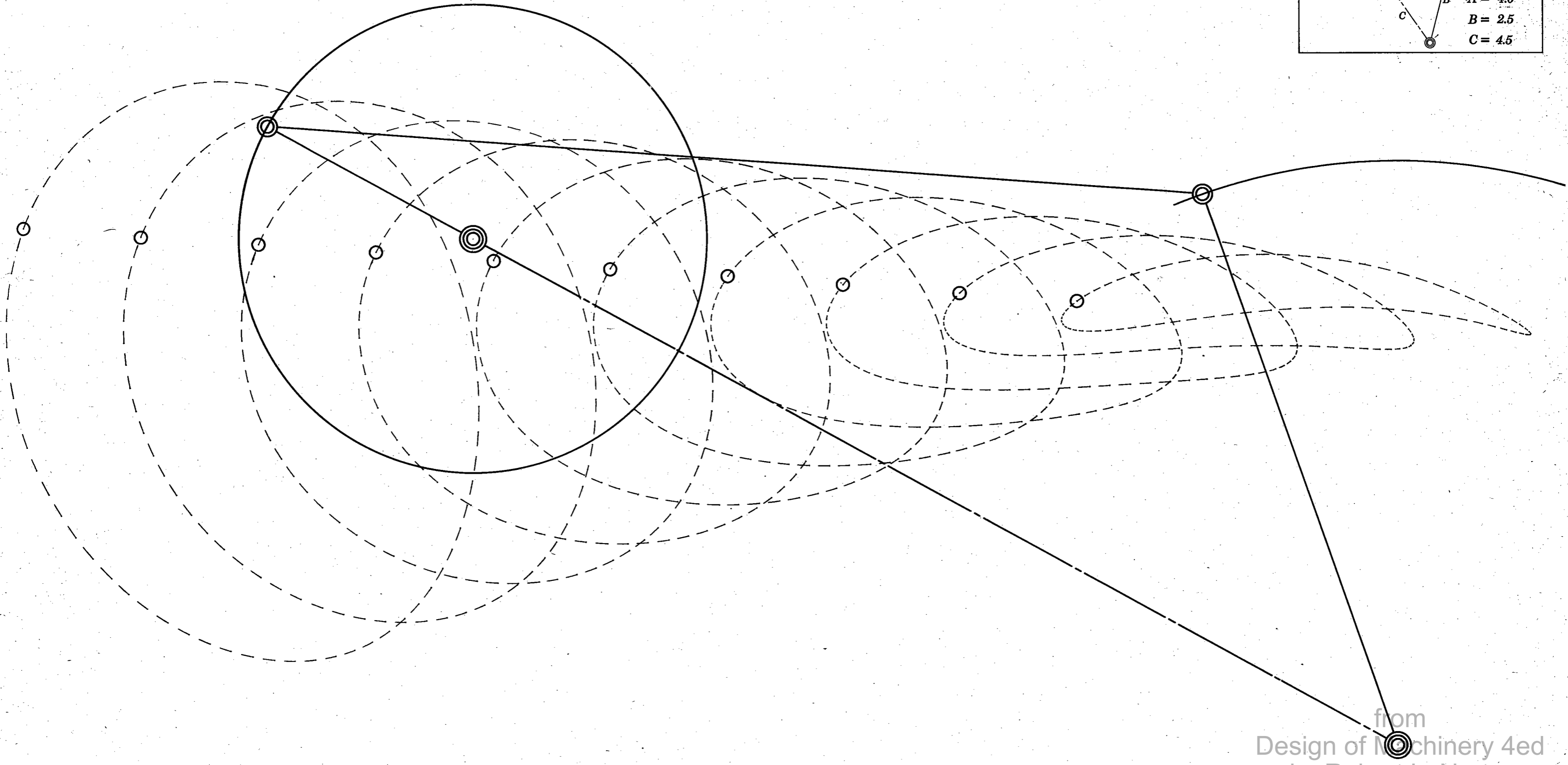
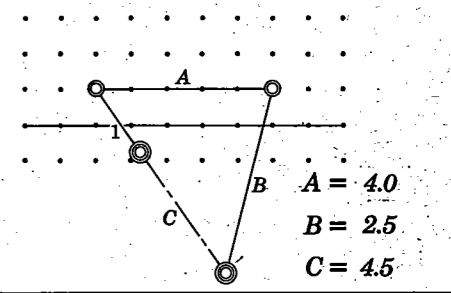

from  
Design of Machinery 4ed  
by Robert L. Norton  
McGraw-Hill  
Copyright 2008

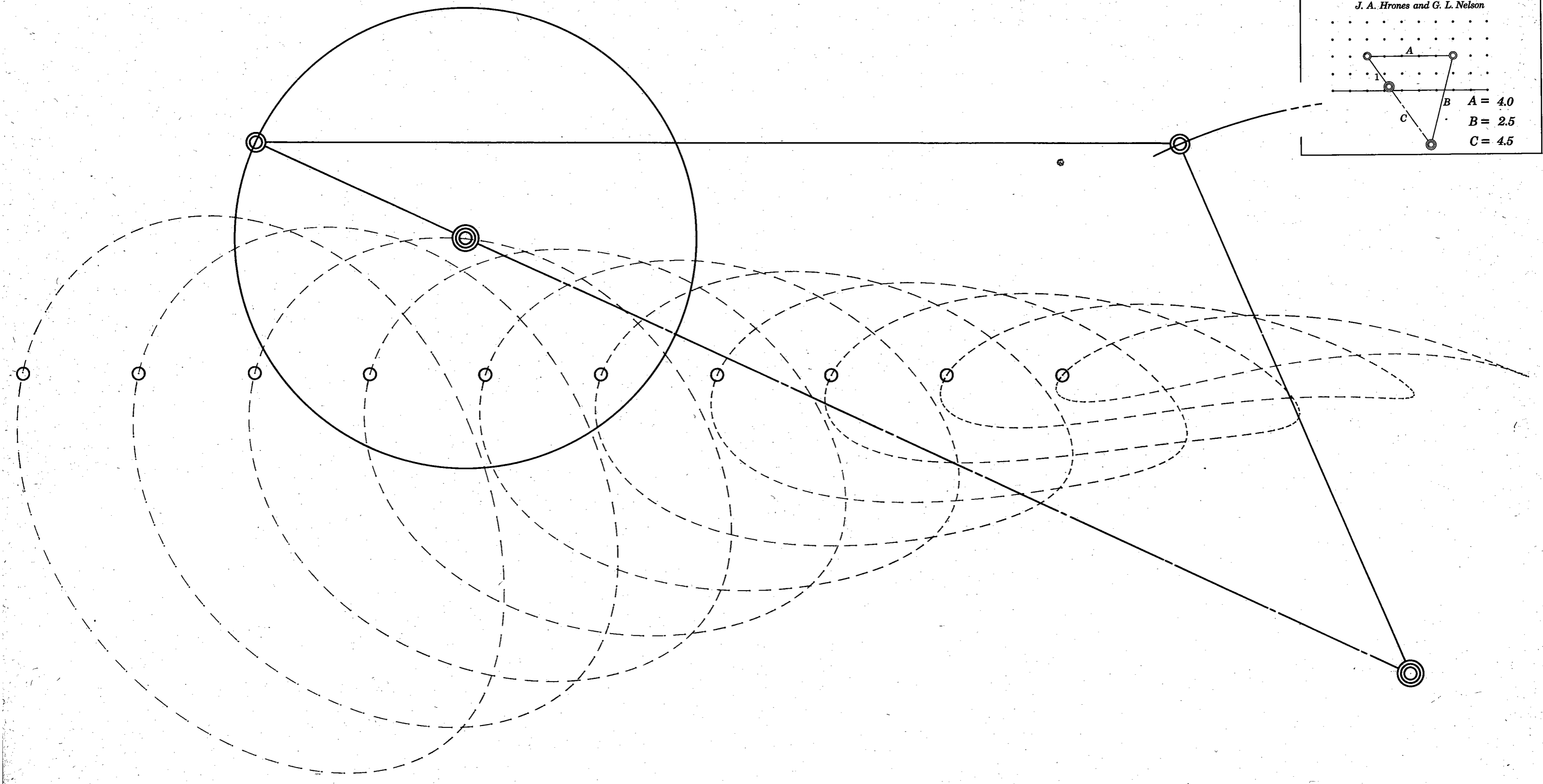
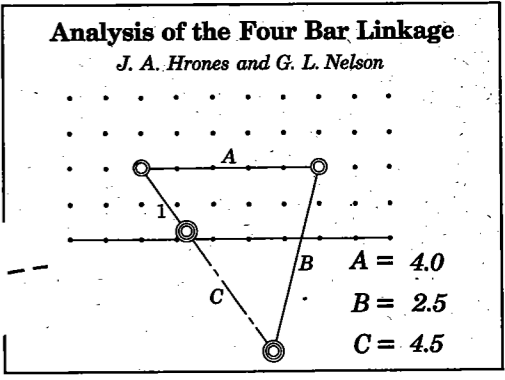

from  
Design of Machinery 4ed  
by Robert L. Norton  
McGraw-Hill  
Copyright 2008

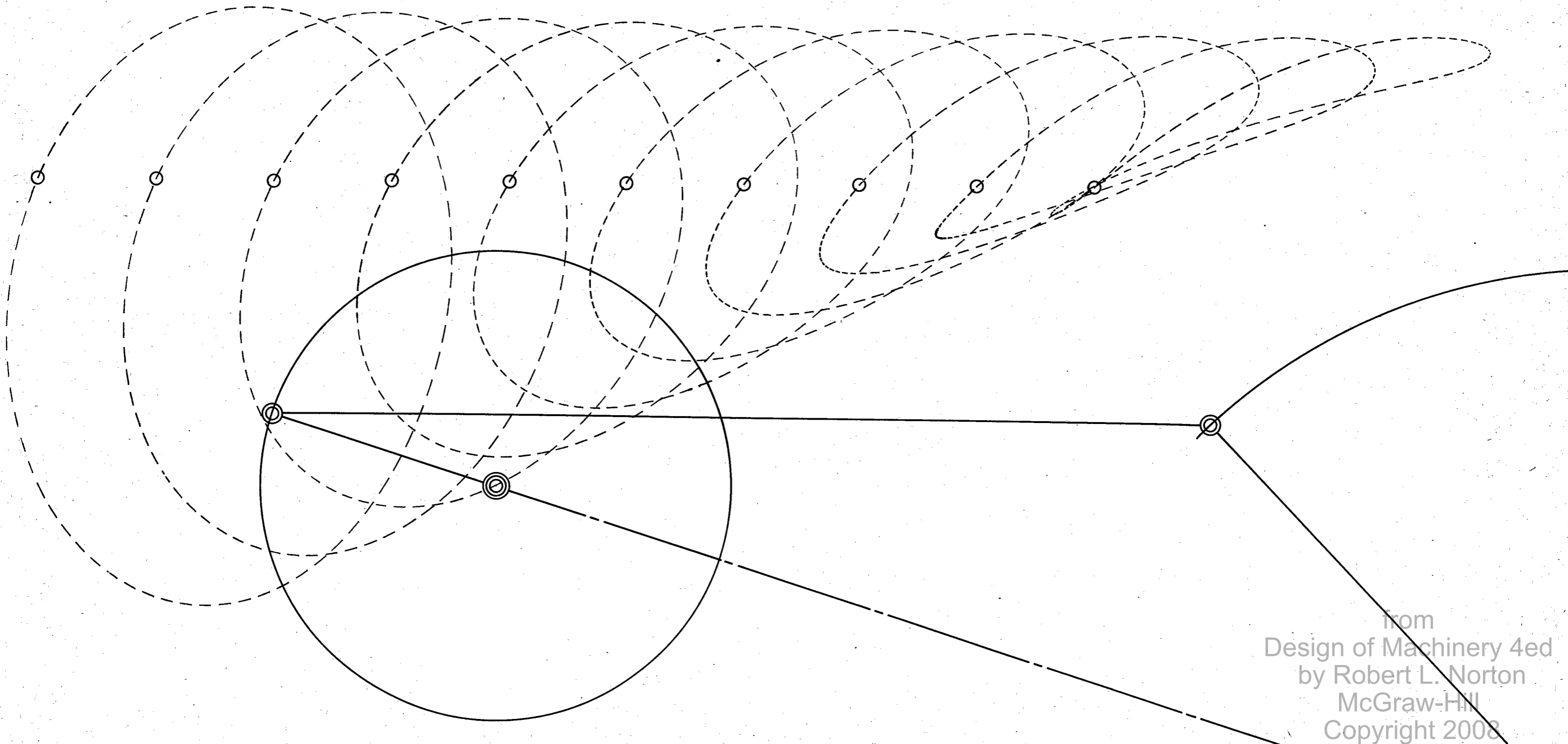
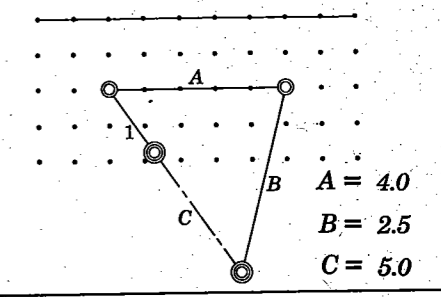

from  
Design of Machinery 4ed  
by Robert L. Norton  
McGraw-Hill  
Copyright 2008

**Analysis of the Four Bar Linkage**  
*J. A. Hrones and G. L. Nelson*

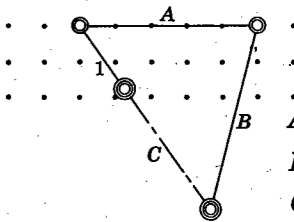

$A = 4.0$   
 $B = 2.5$   
 $C = 5.0$

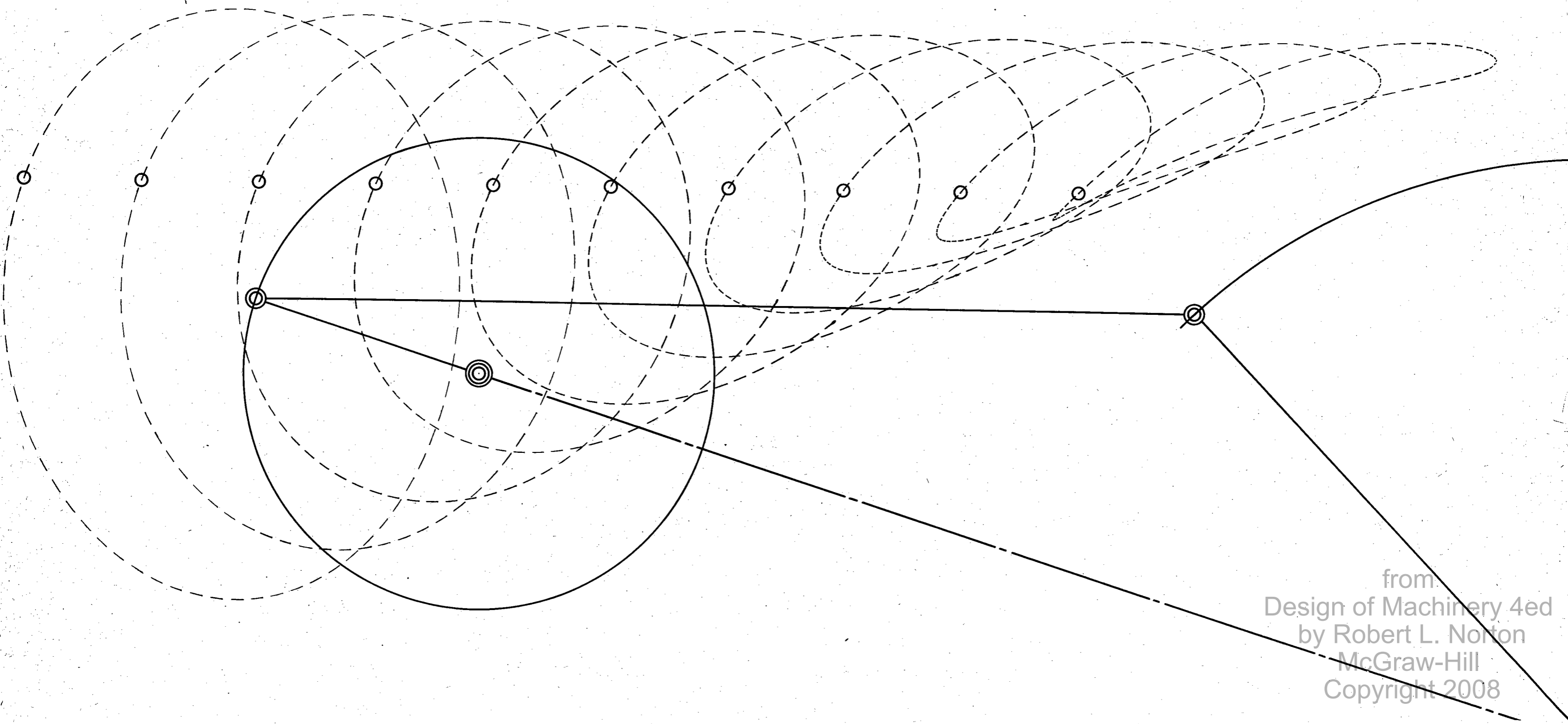

from  
Design of Machinery 4ed  
by Robert L. Norton  
McGraw-Hill  
Copyright 2008

**Analysis of the Four Bar Linkage**

*J. A. Hrones and G. L. Nelson*

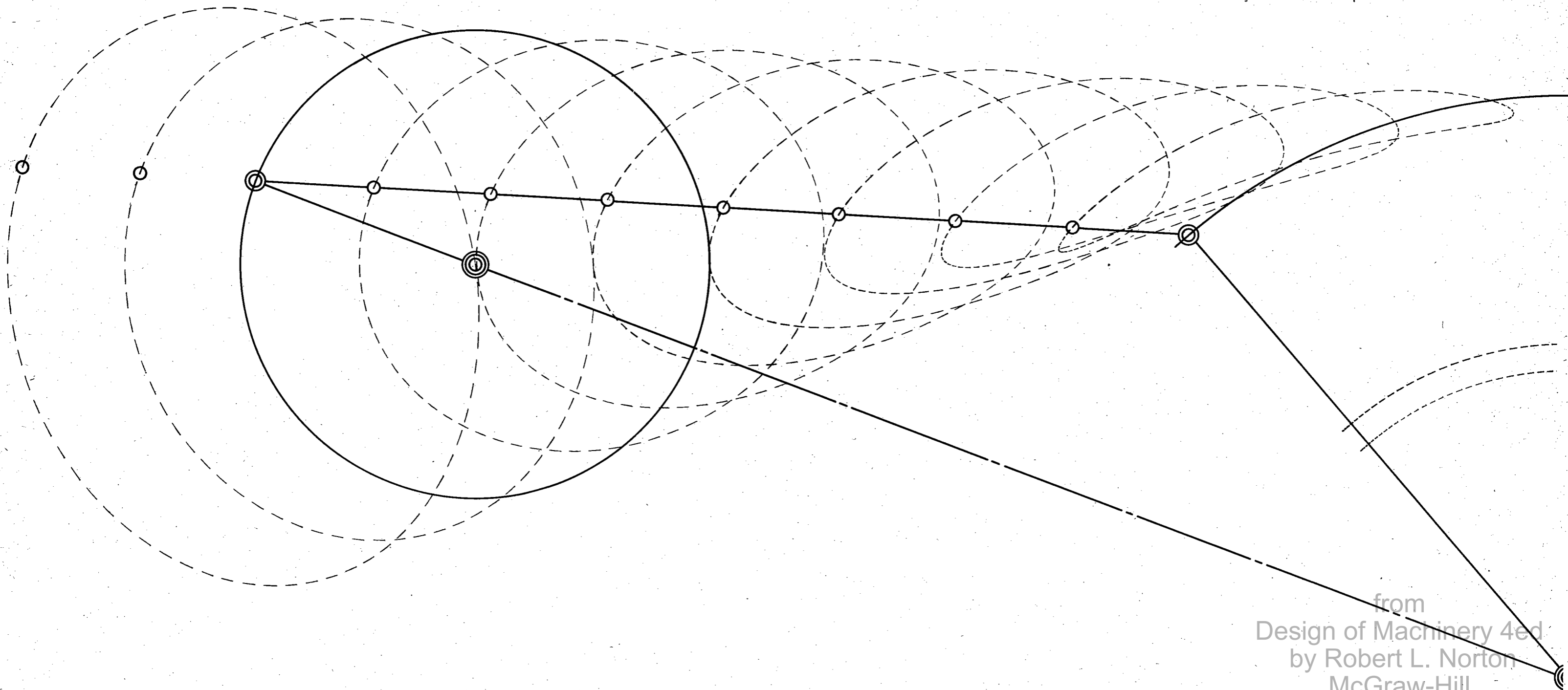
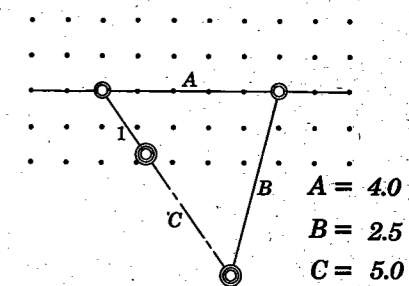

from  
Design of Machinery 4ed  
by Robert L. Norton  
McGraw-Hill  
Copyright 2008

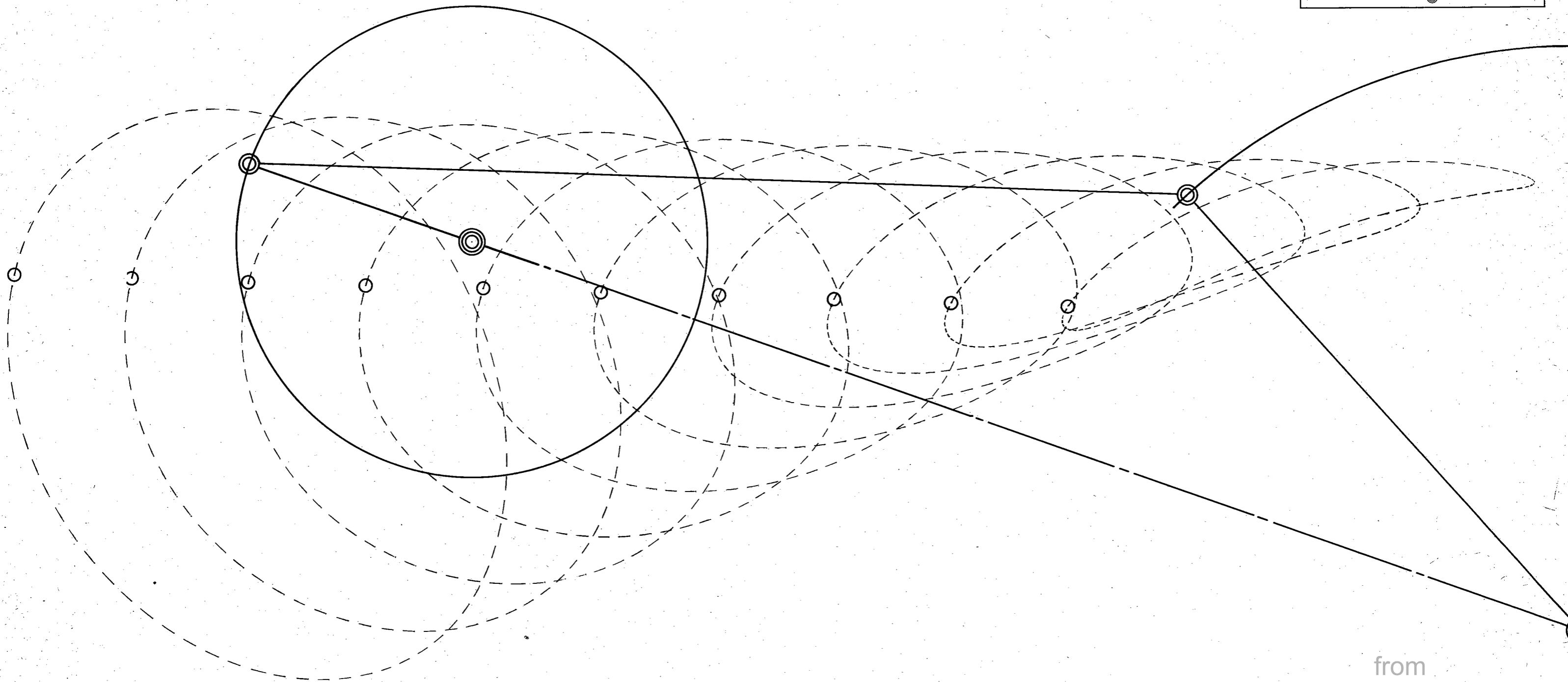
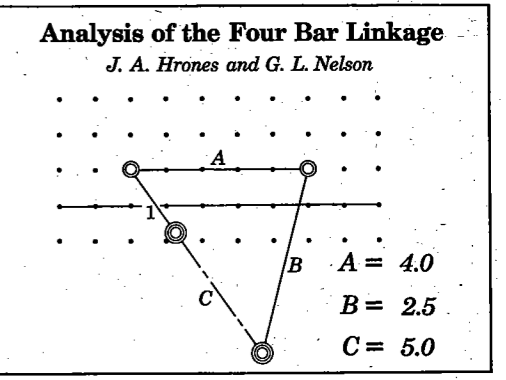

from  
Design of Machinery 4ed  
by Robert L. Norton  
McGraw-Hill  
Copyright 2008

**Analysis of the Four Bar Linkage**

*J. A. Hrones and G. L. Nelson*

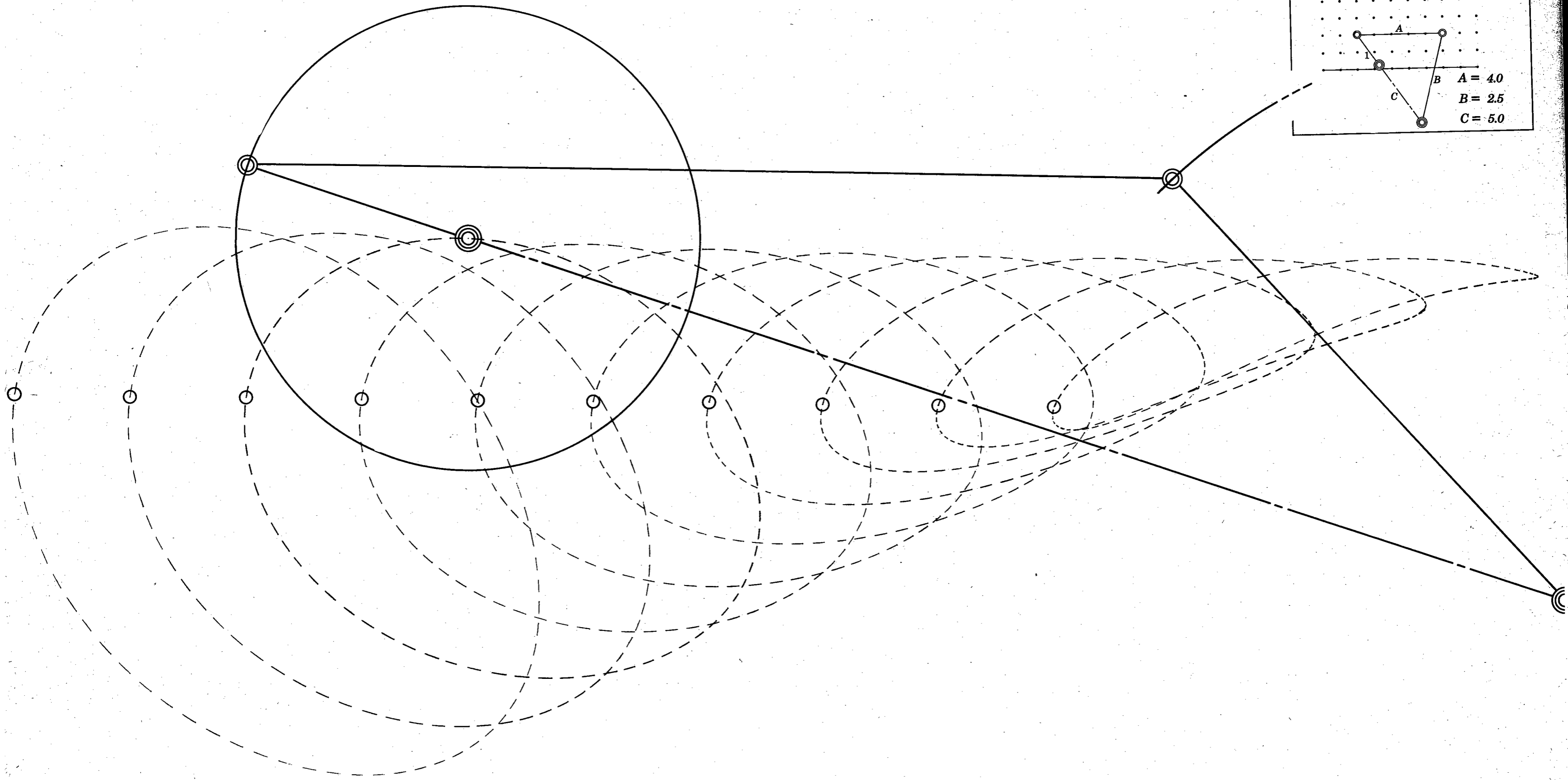
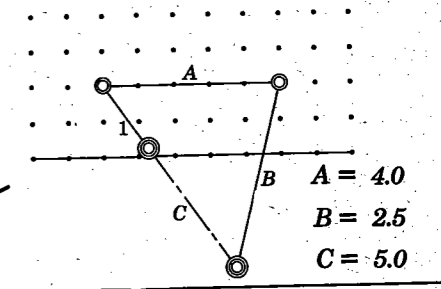

from  
Design of Machinery 4ed  
by Robert L. Norton  
McGraw-Hill  
Copyright 2008



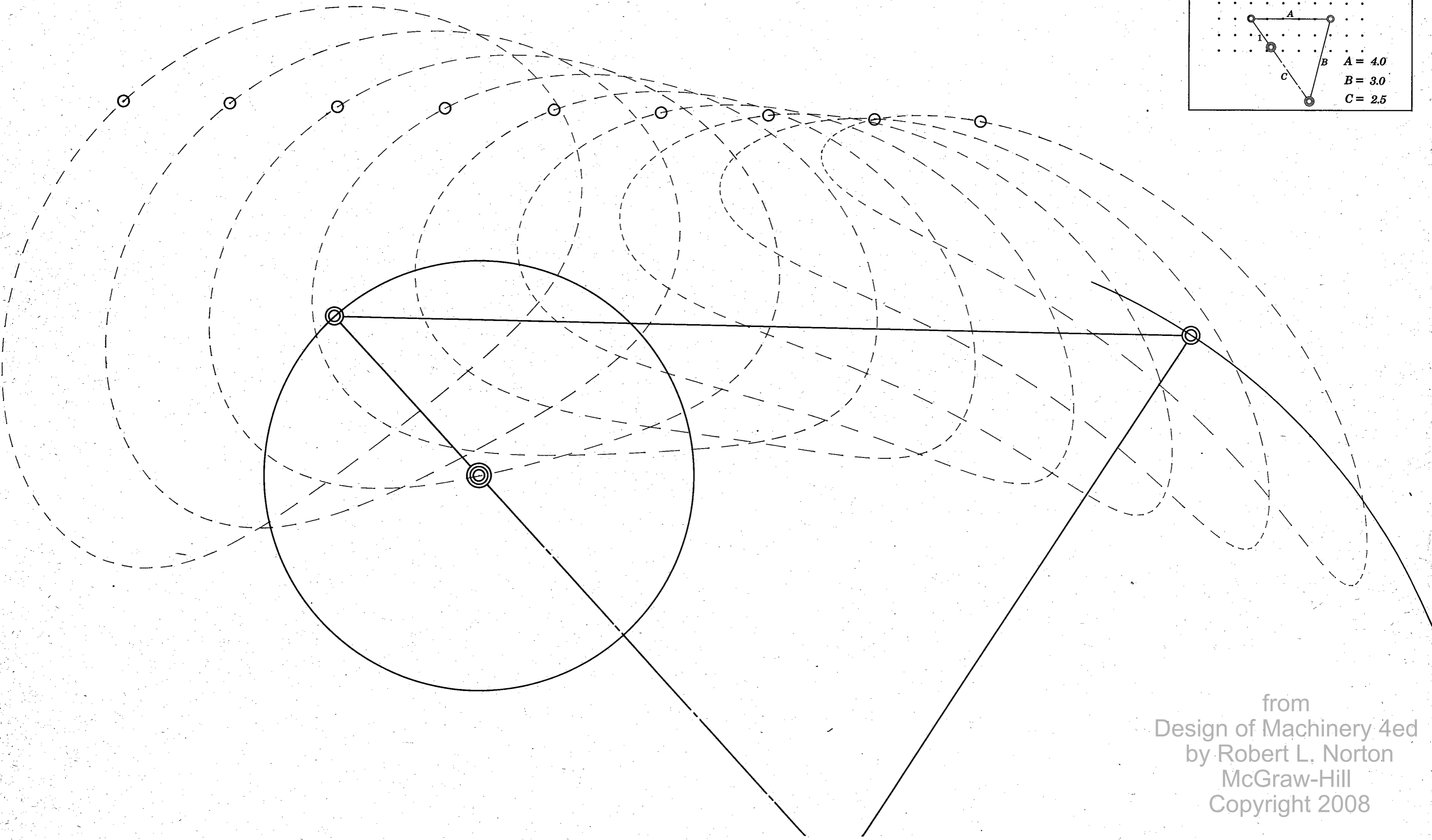
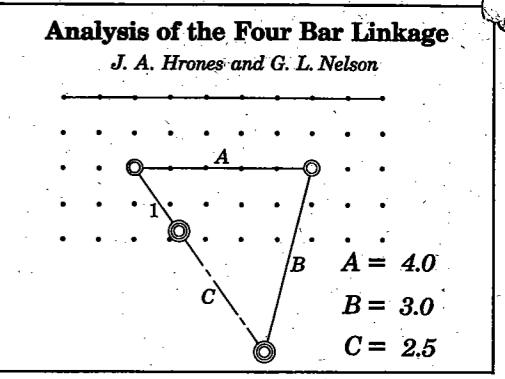

from  
Design of Machinery 4ed  
by Robert L. Norton  
McGraw-Hill  
Copyright 2008

**Analysis of the Four Bar Linkage**  
*J. A. Hrones and G. L. Nelson*

$A = 4.0$   
 $B = 3.0$   
 $C = 2.5$

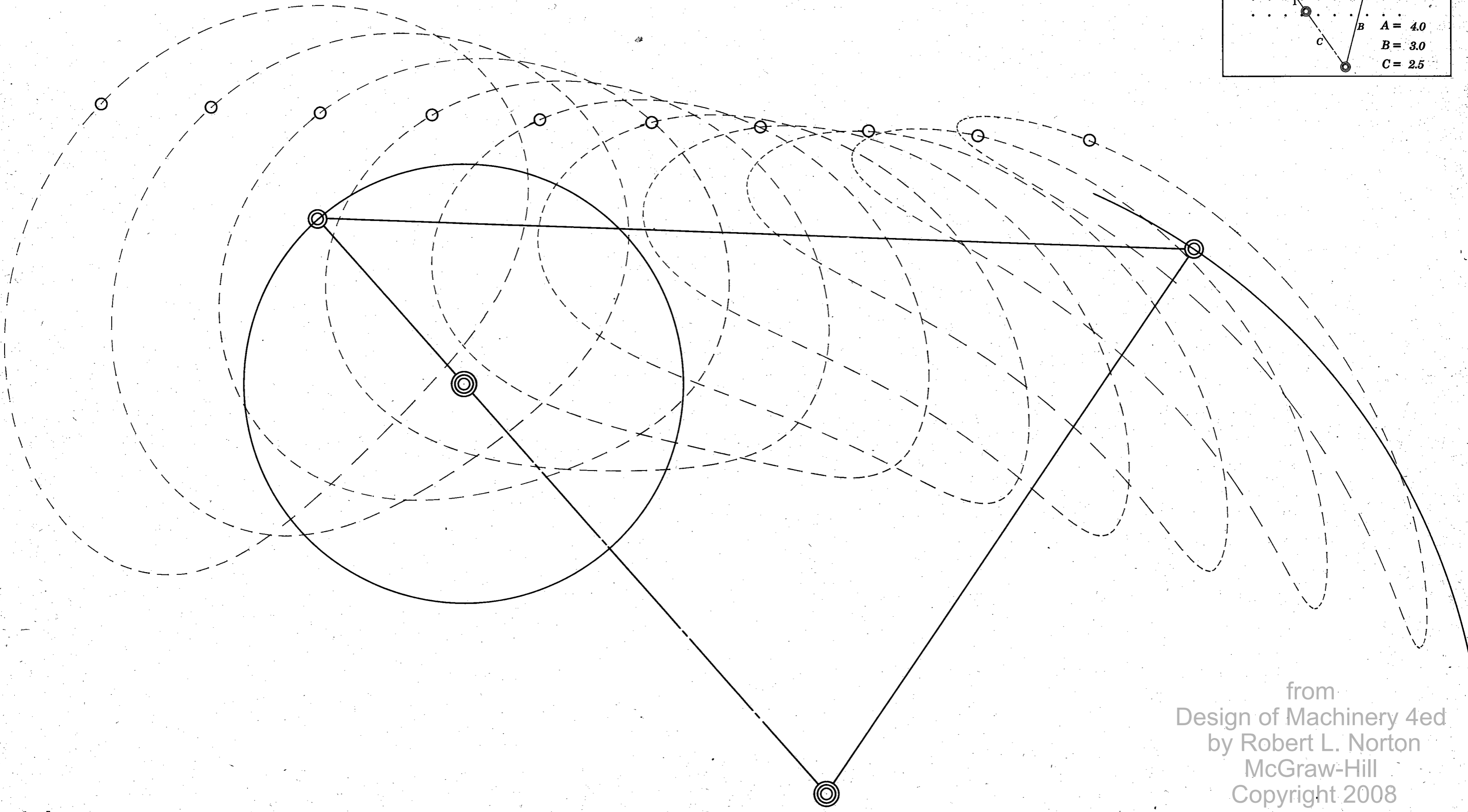

from  
 Design of Machinery 4ed  
 by Robert L. Norton  
 McGraw-Hill  
 Copyright 2008

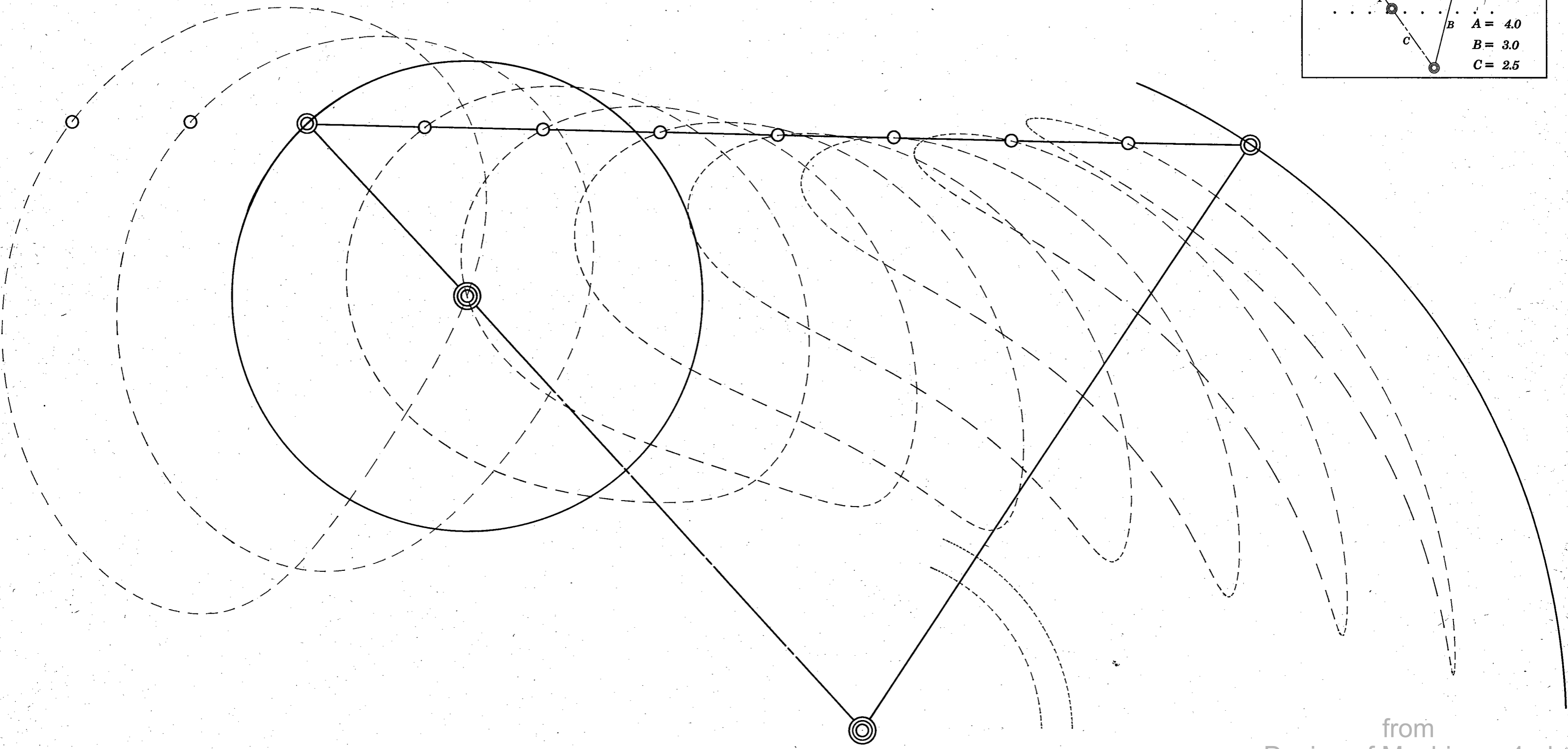
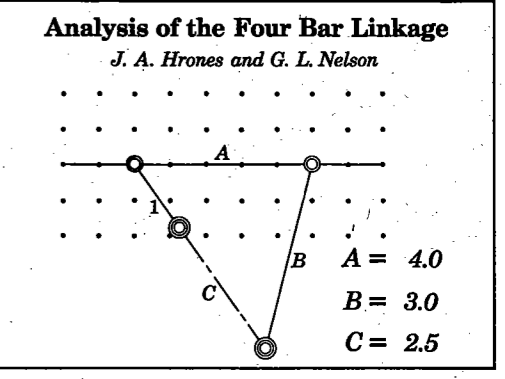

from  
Design of Machinery 4ed  
by Robert L. Norton  
McGraw-Hill  
Copyright 2008

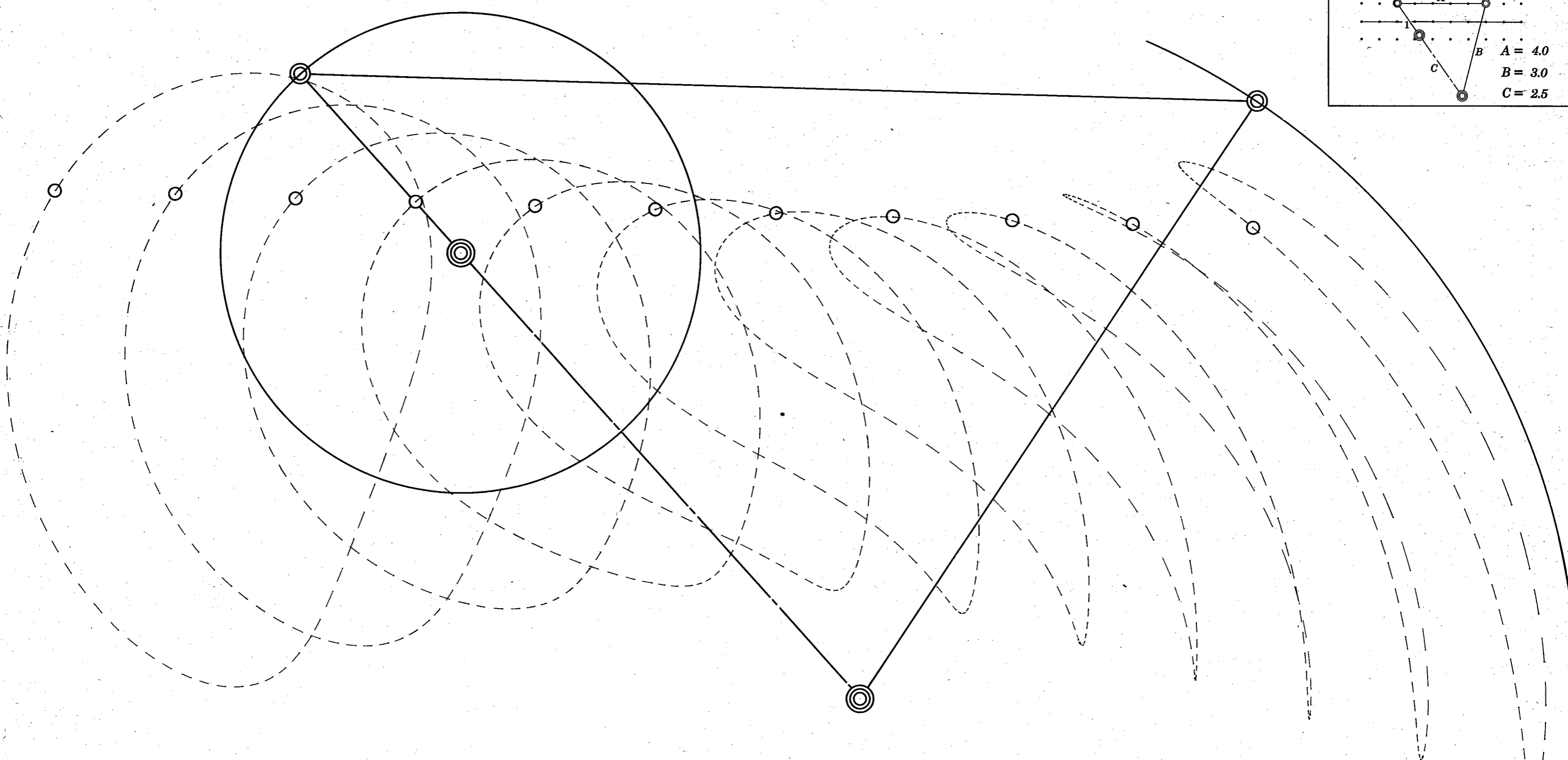
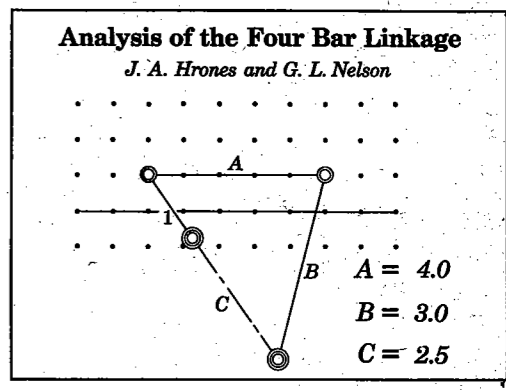

from  
 Design of Machinery 4ed  
 by Robert L. Norton  
 McGraw-Hill  
 Copyright 2008

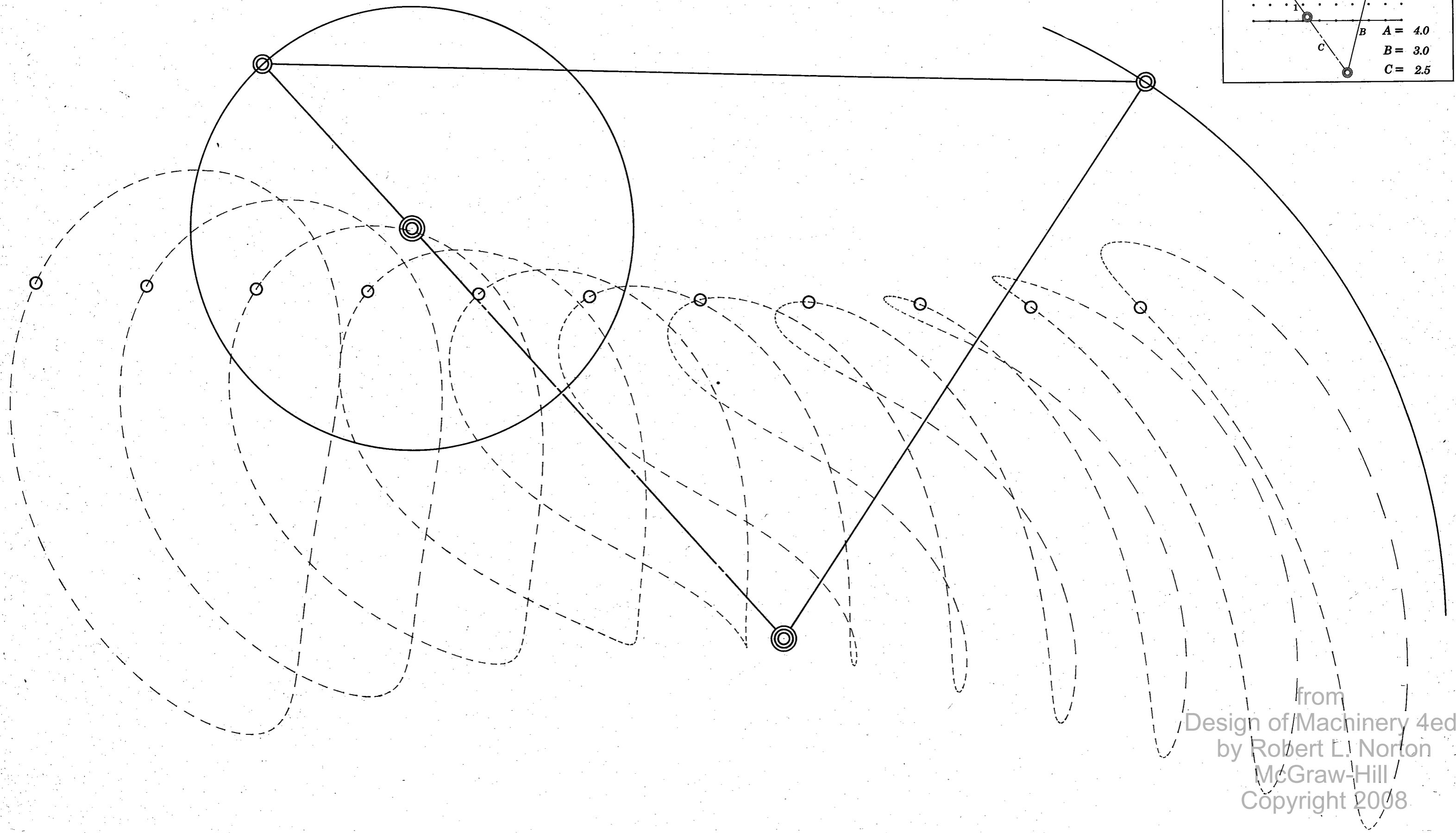
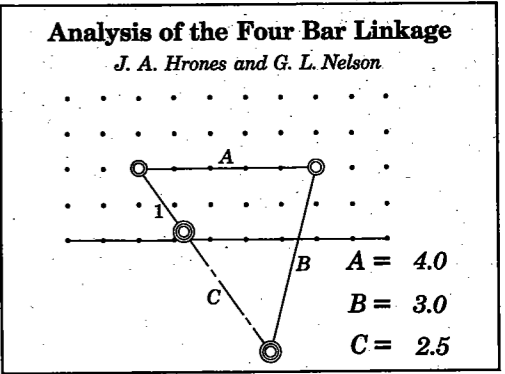

from  
Design of Machinery 4ed  
by Robert L. Norton  
McGraw-Hill  
Copyright 2008

**Analysis of the Four Bar Linkage**

*J. A. Hrones and G. L. Nelson*

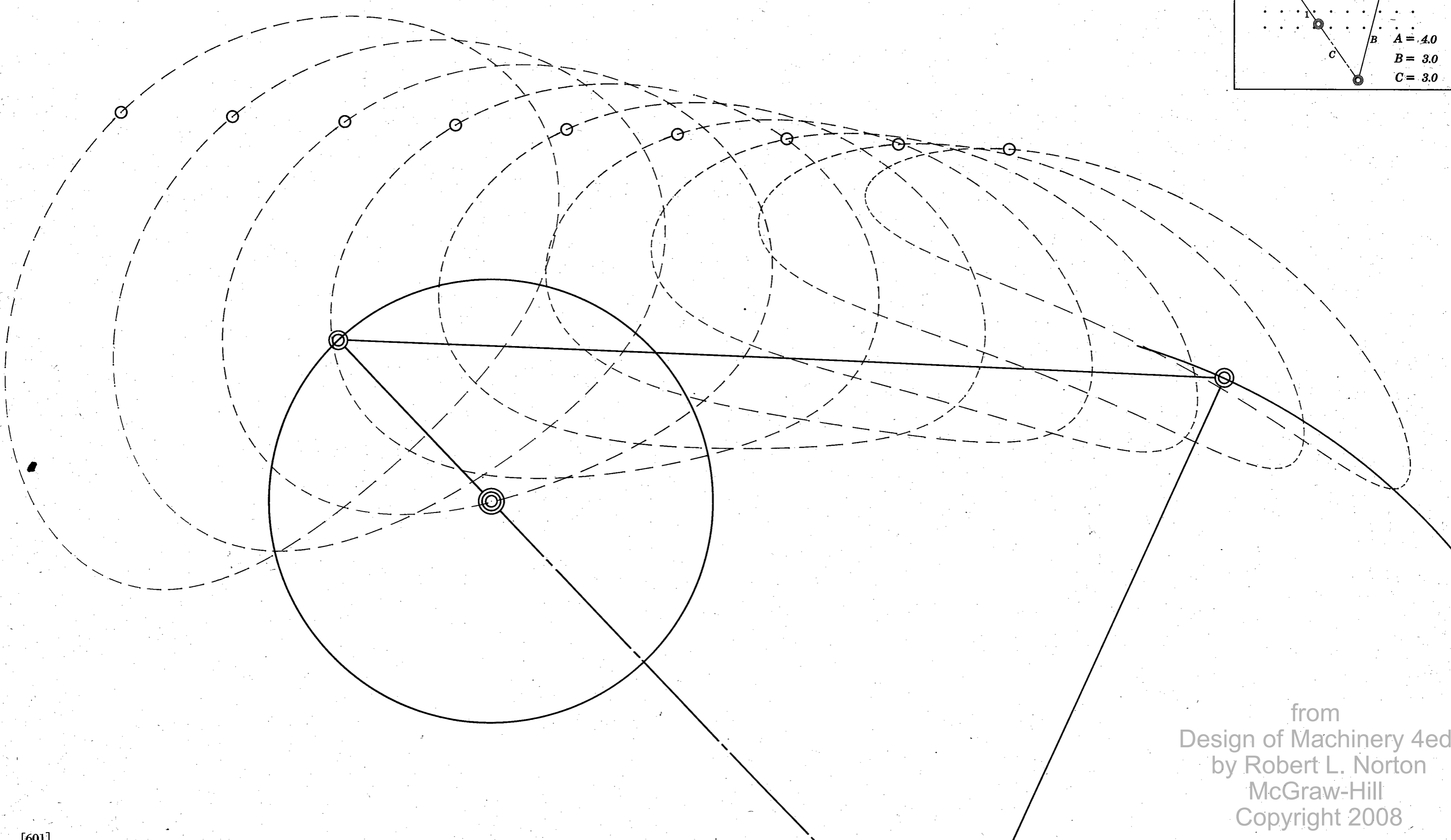
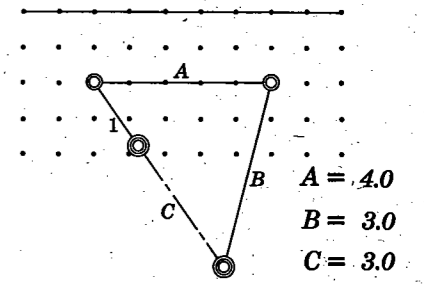

from  
Design of Machinery 4ed  
by Robert L. Norton  
McGraw-Hill  
Copyright 2008

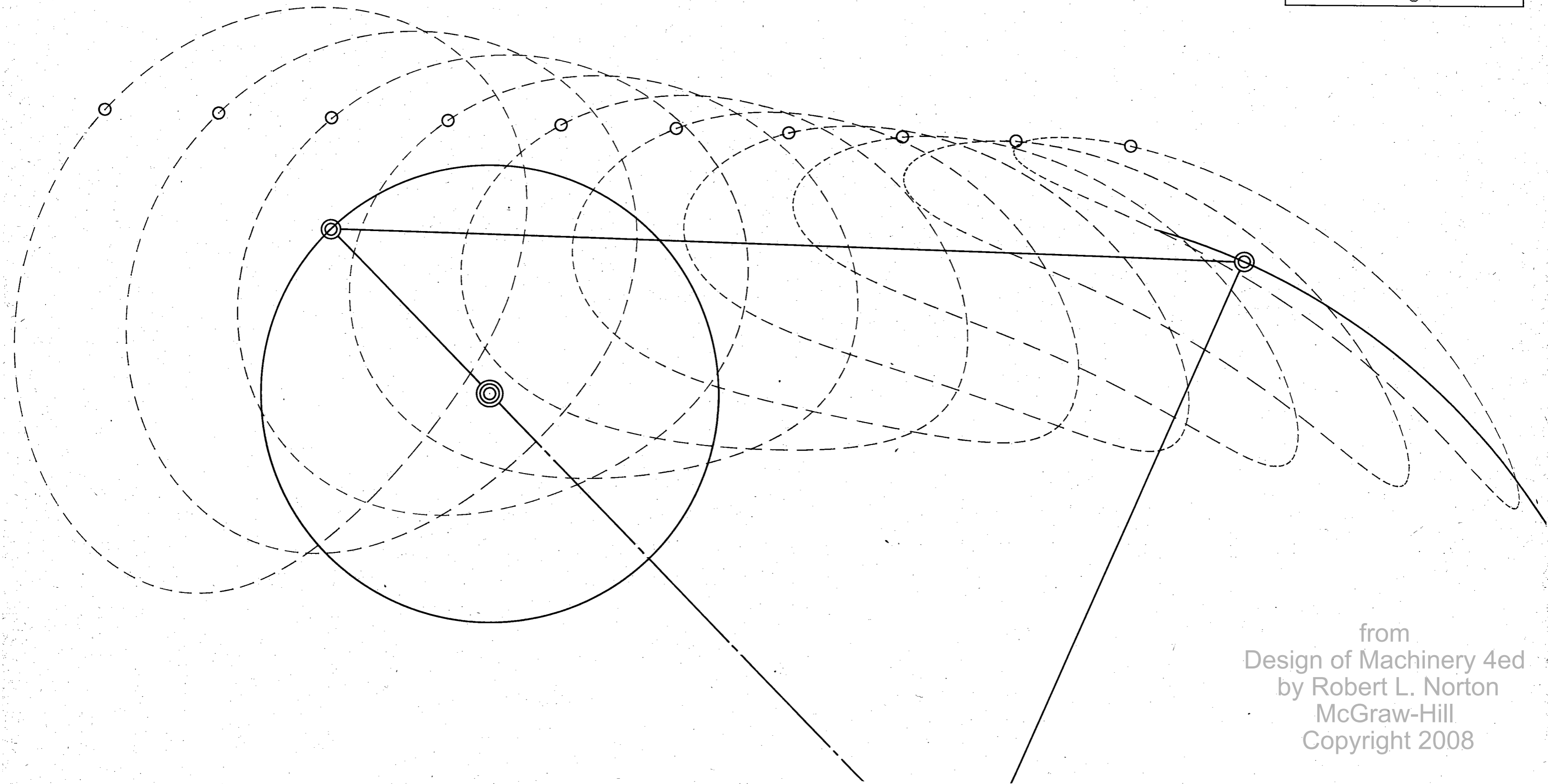
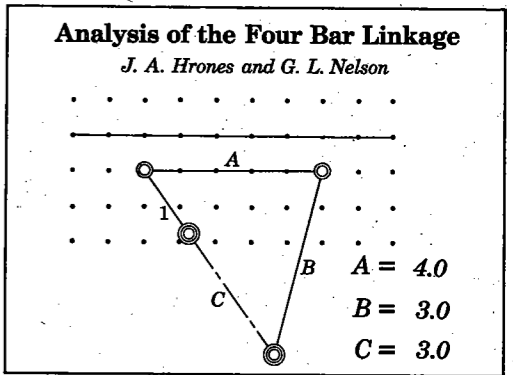

from  
Design of Machinery 4ed  
by Robert L. Norton  
McGraw-Hill  
Copyright 2008

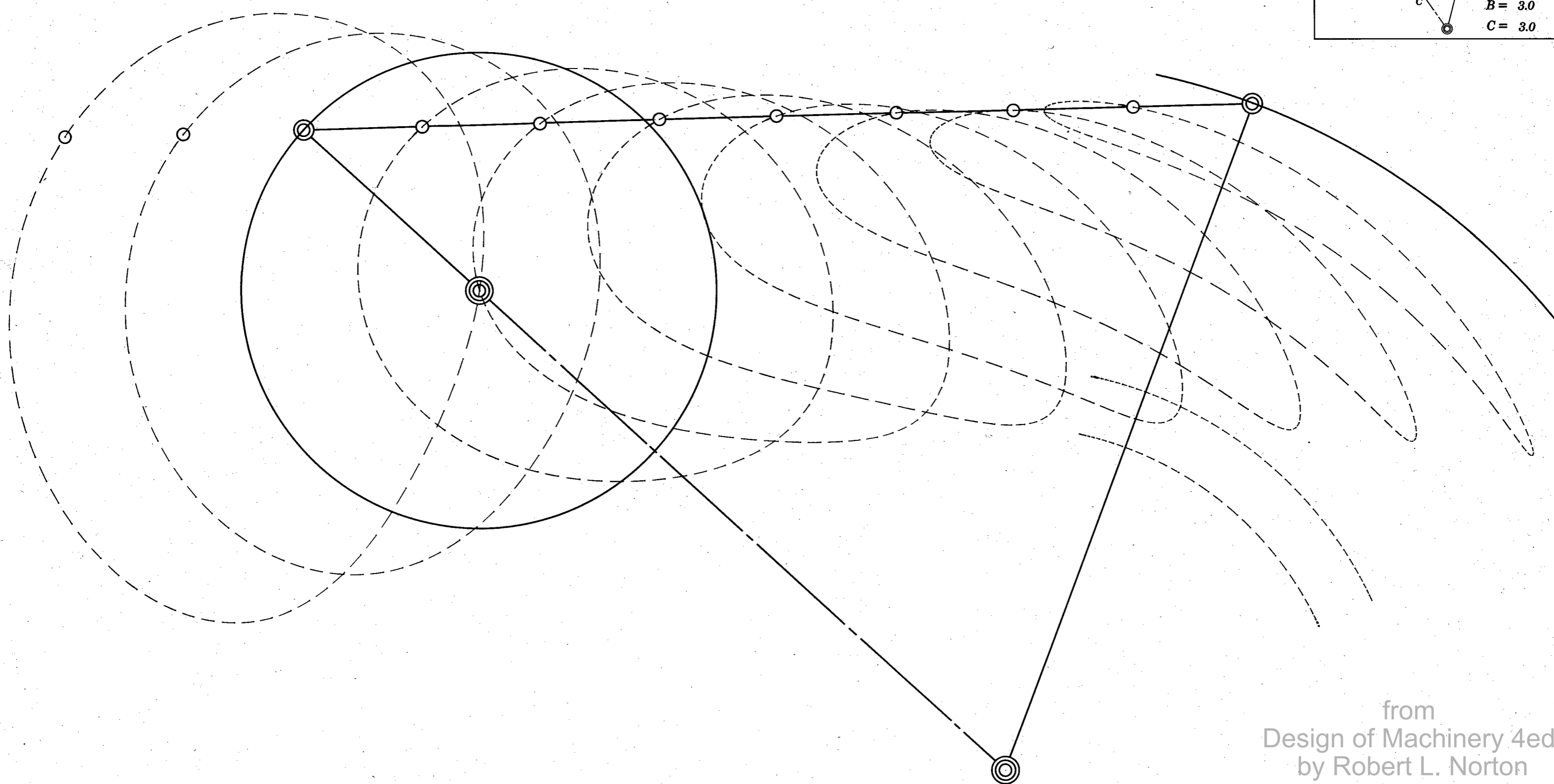
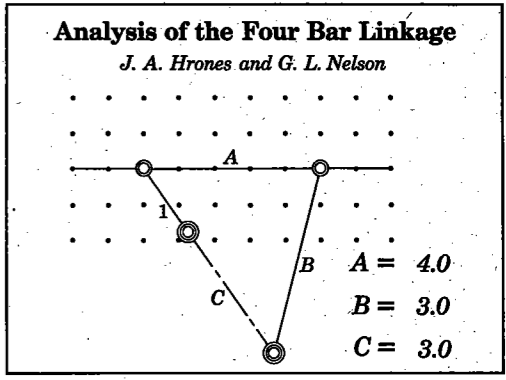

from  
 Design of Machinery 4ed  
 by Robert L. Norton  
 McGraw-Hill  
 Copyright 2008



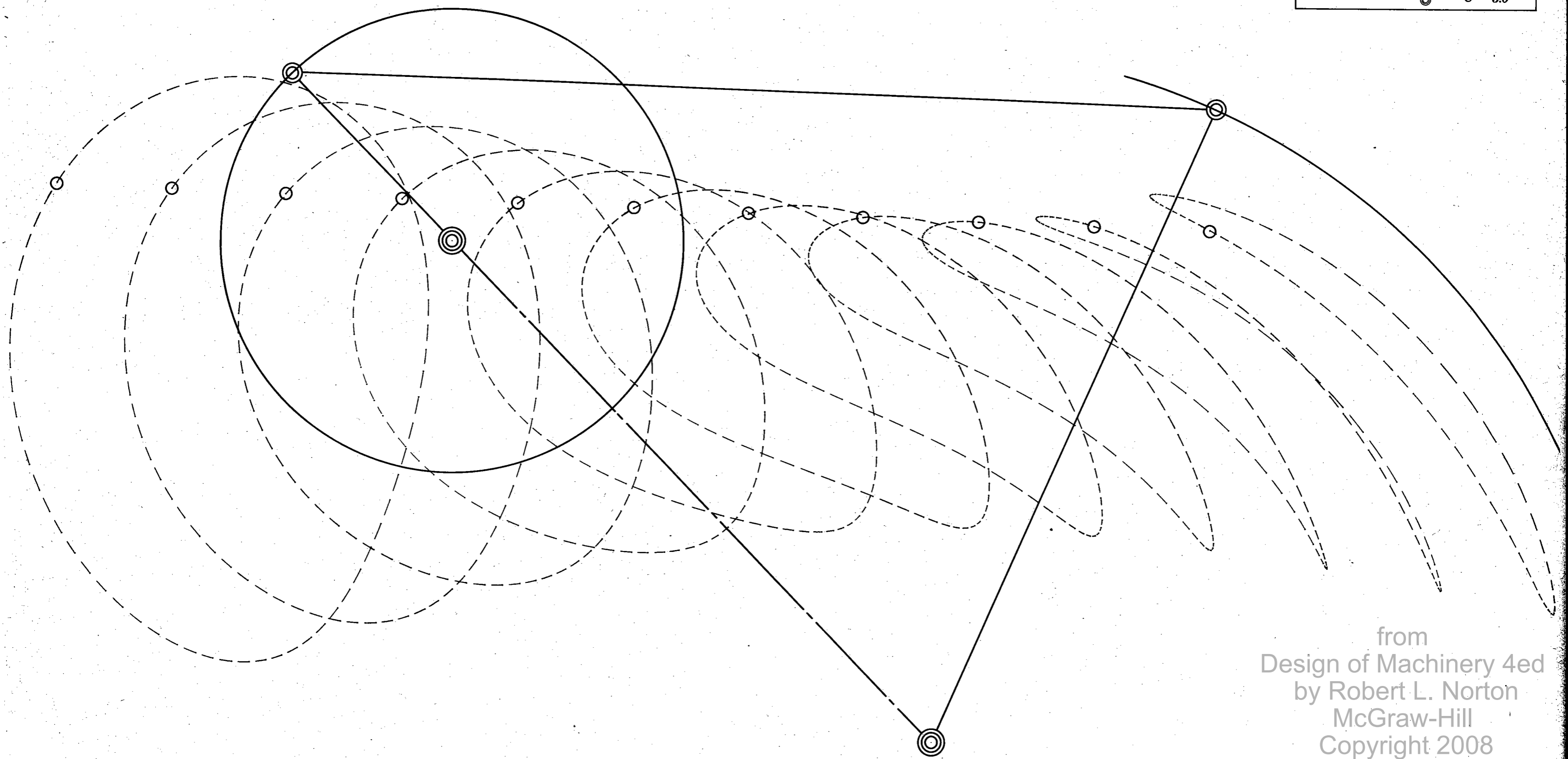
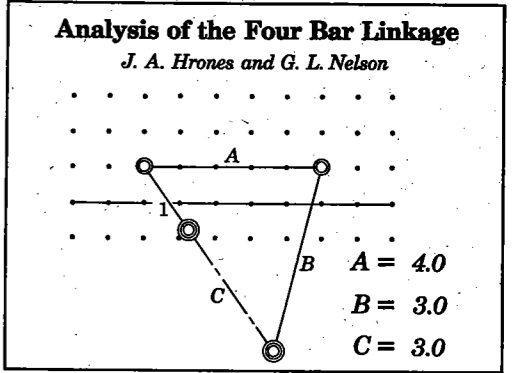

from  
Design of Machinery 4ed  
by Robert L. Norton  
McGraw-Hill  
Copyright 2008

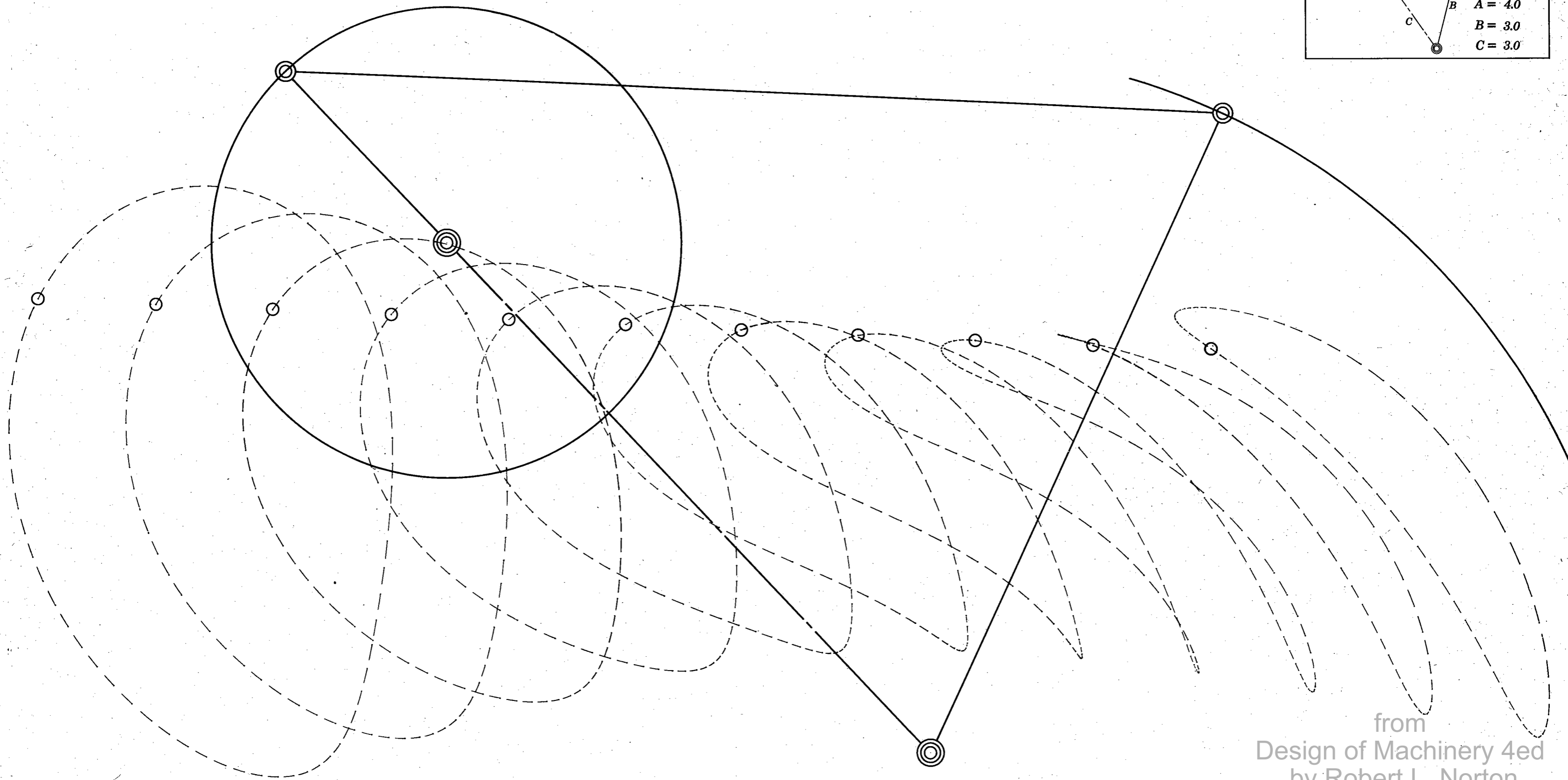
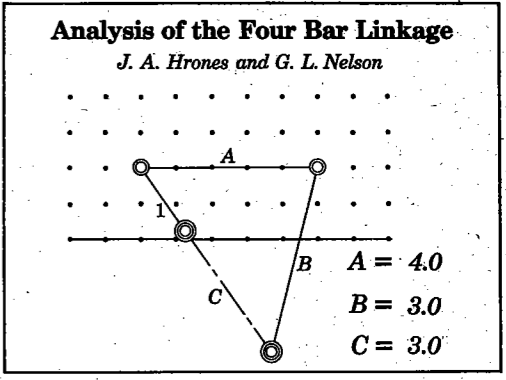

from  
 Design of Machinery 4ed  
 by Robert L. Norton  
 McGraw-Hill  
 Copyright 2008

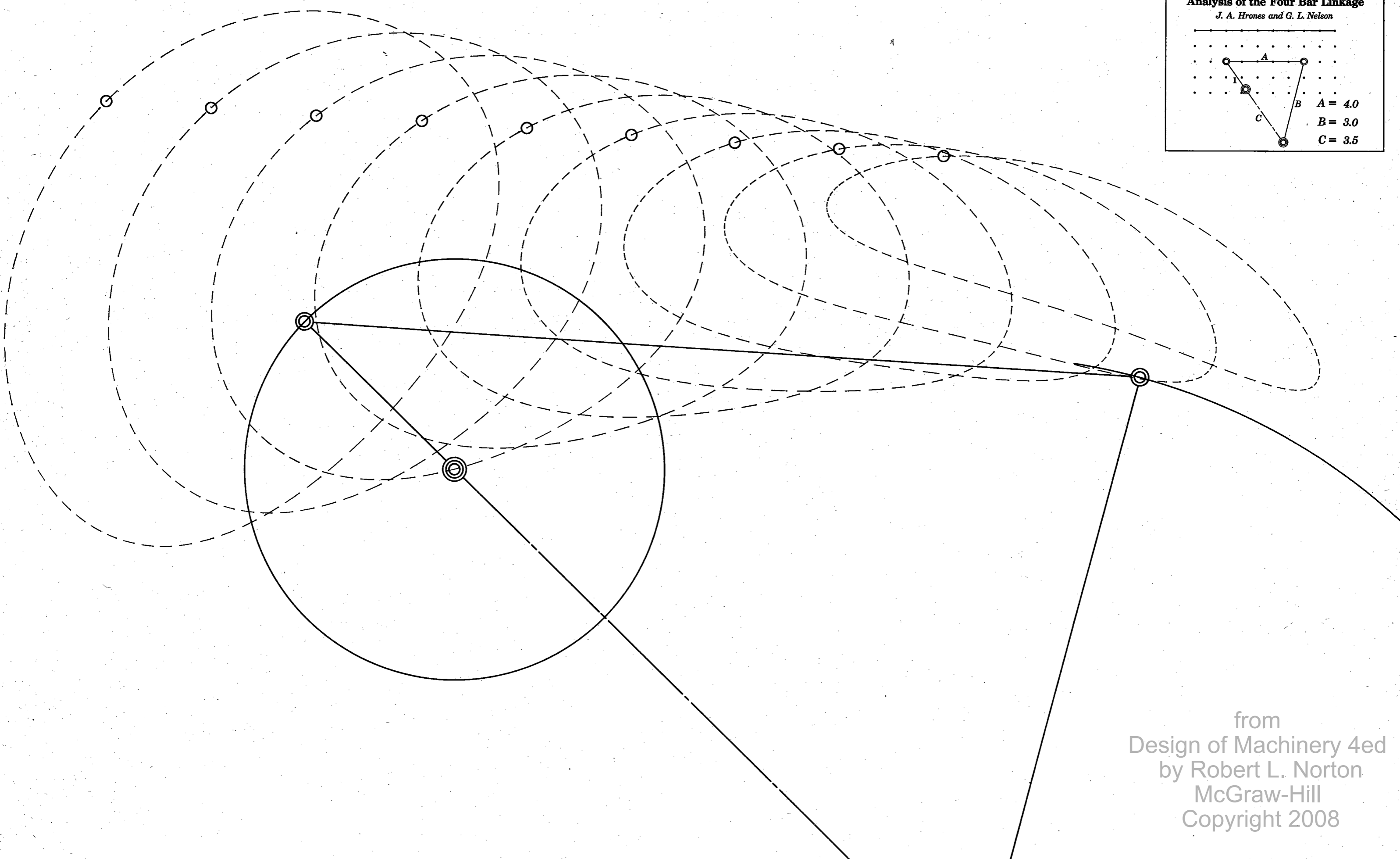
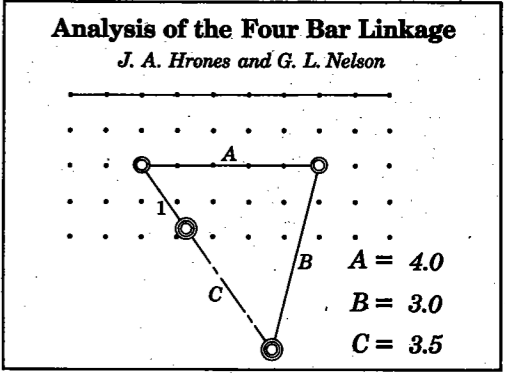

from  
Design of Machinery 4ed  
by Robert L. Norton  
McGraw-Hill  
Copyright 2008

**Analysis of the Four Bar Linkage**  
*J. A. Hrones and G. L. Nelson*

$A = 4.0$   
 $B = 3.0$   
 $C = 3.5$

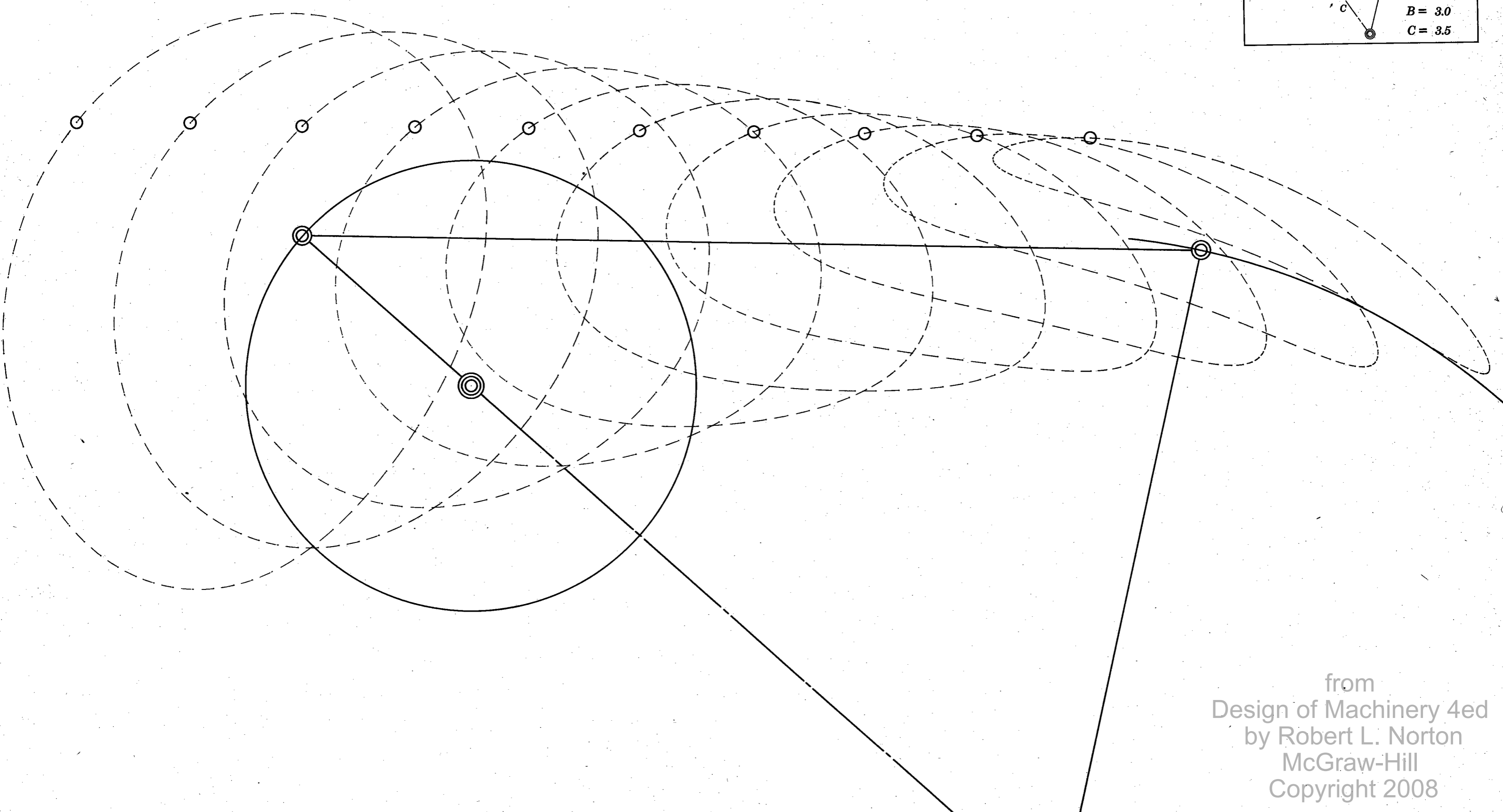

from  
 Design of Machinery 4ed  
 by Robert L. Norton  
 McGraw-Hill  
 Copyright 2008

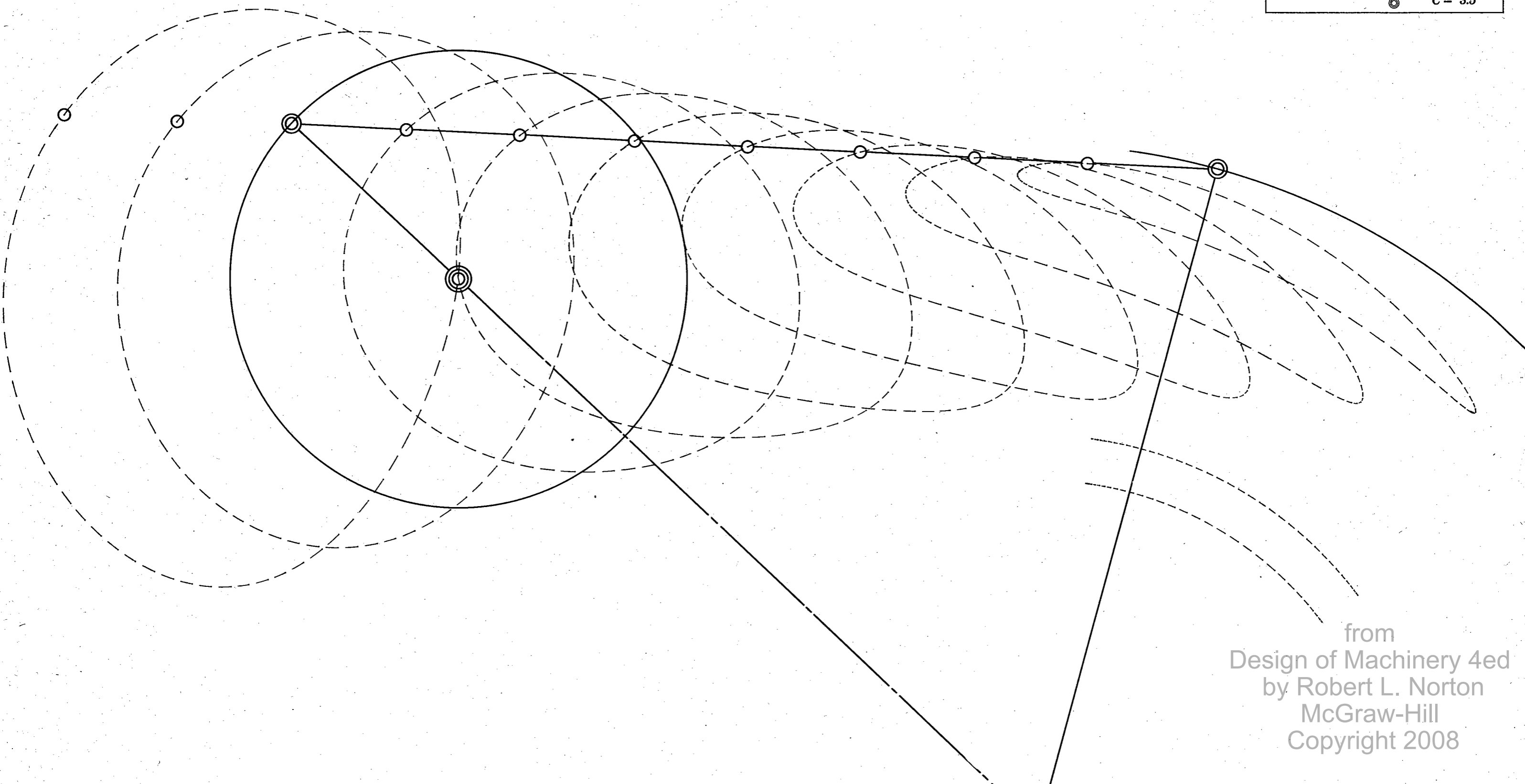
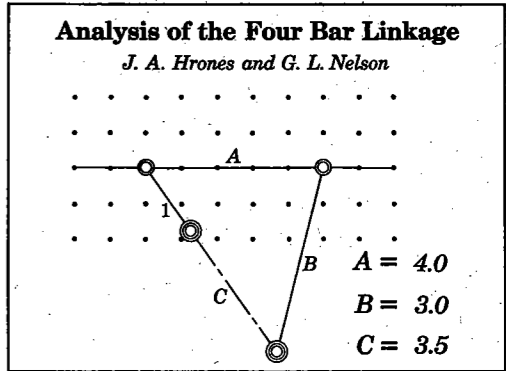

from  
Design of Machinery 4ed  
by Robert L. Norton  
McGraw-Hill  
Copyright 2008

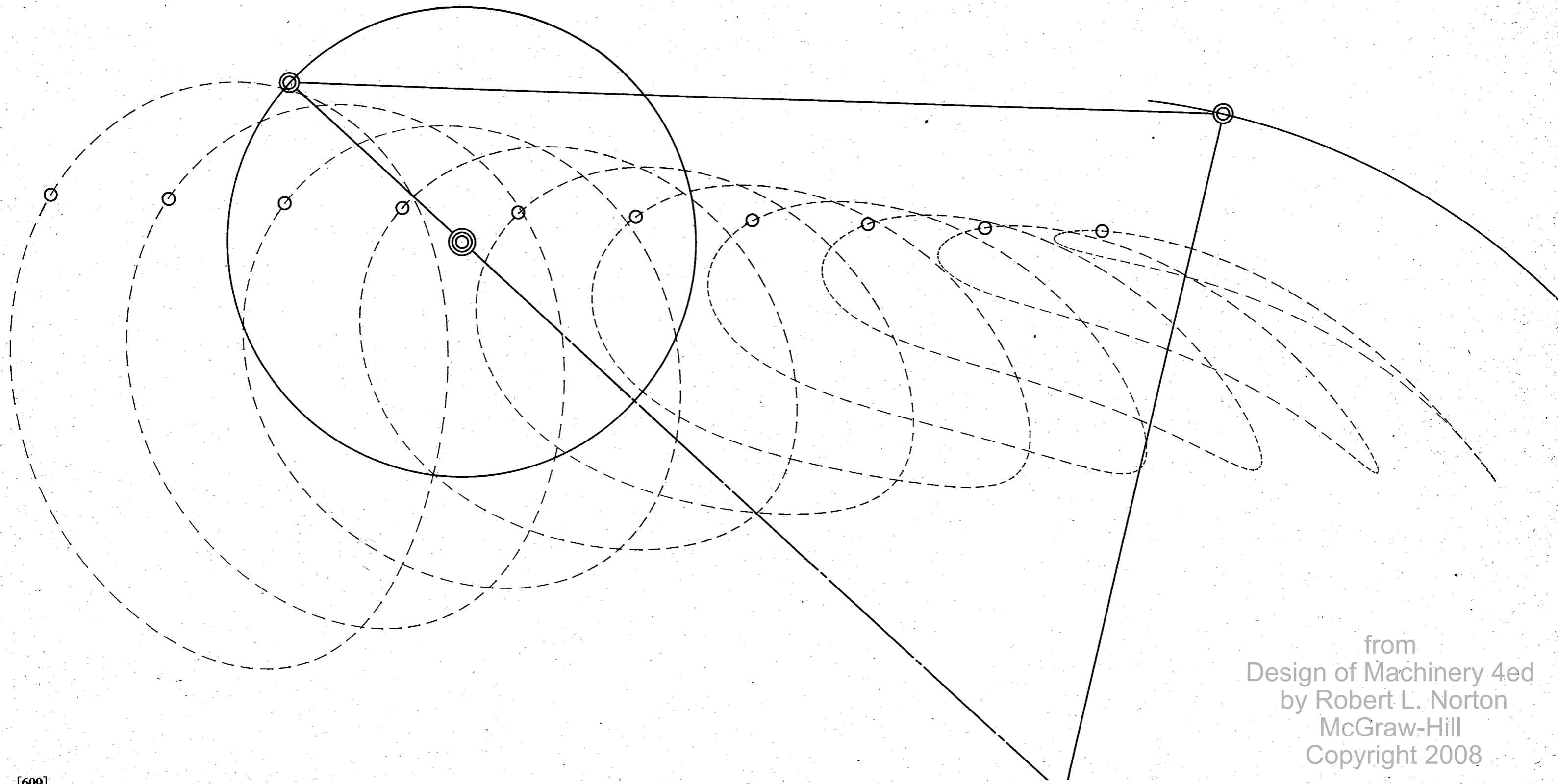
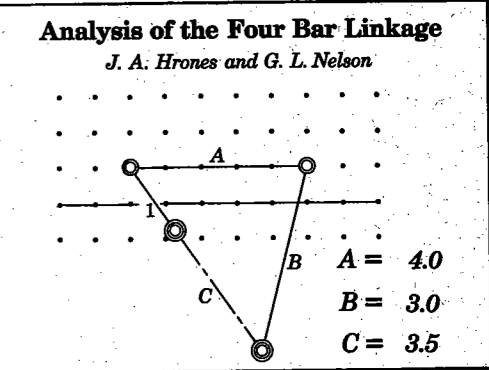

from  
 Design of Machinery 4ed  
 by Robert L. Norton  
 McGraw-Hill  
 Copyright 2008

**Analysis of the Four Bar Linkage**  
*J. A. Hrones and G. L. Nelson*

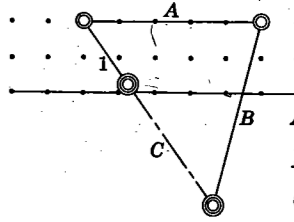

$A = 4.0$   
 $B = 3.0$   
 $C = 3.5$

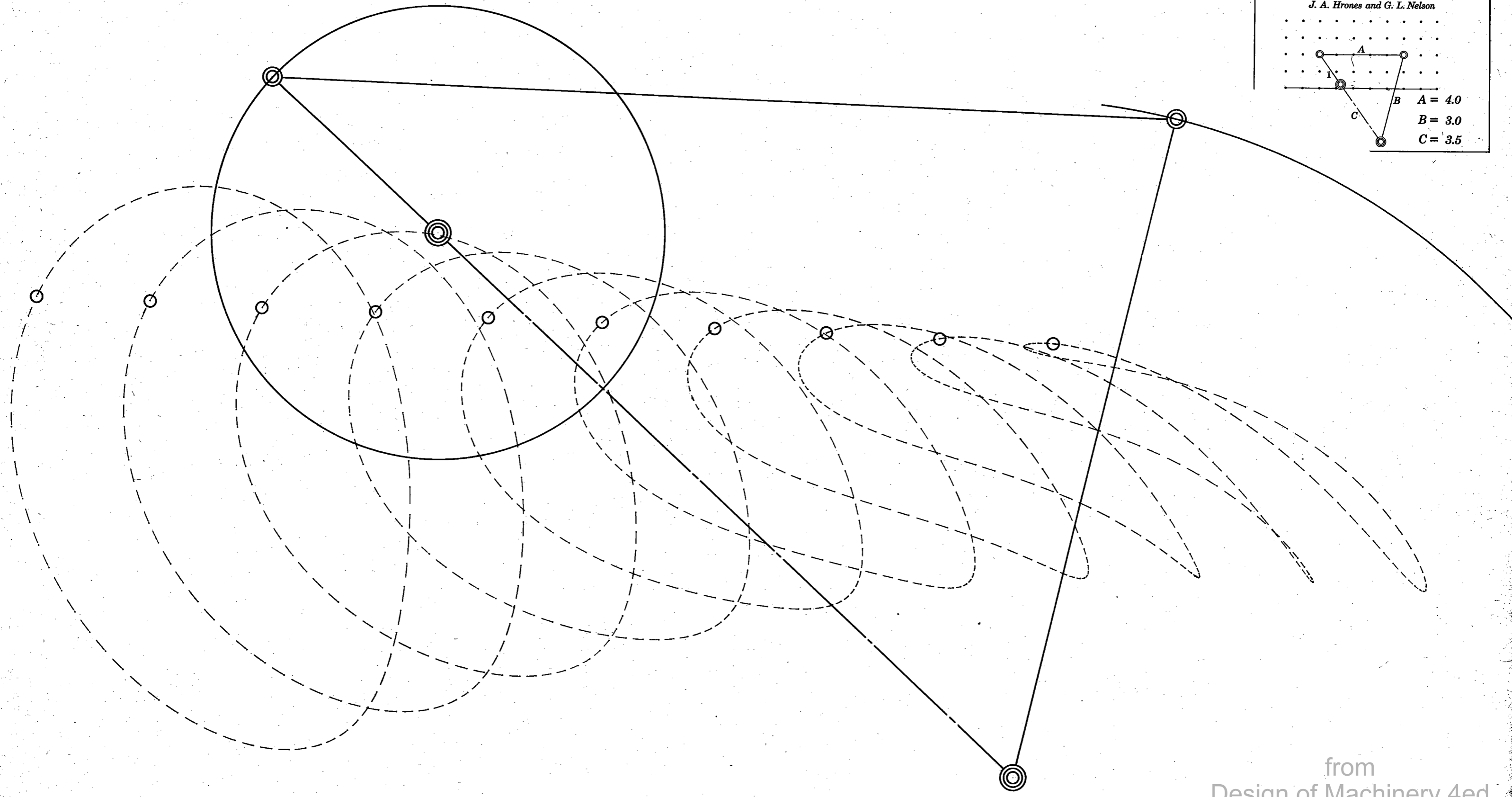

from  
Design of Machinery 4ed  
by Robert L. Norton  
McGraw-Hill  
Copyright 2008

**Analysis of the Four Bar Linkage**

*J. A. Hrones and G. L. Nelson*

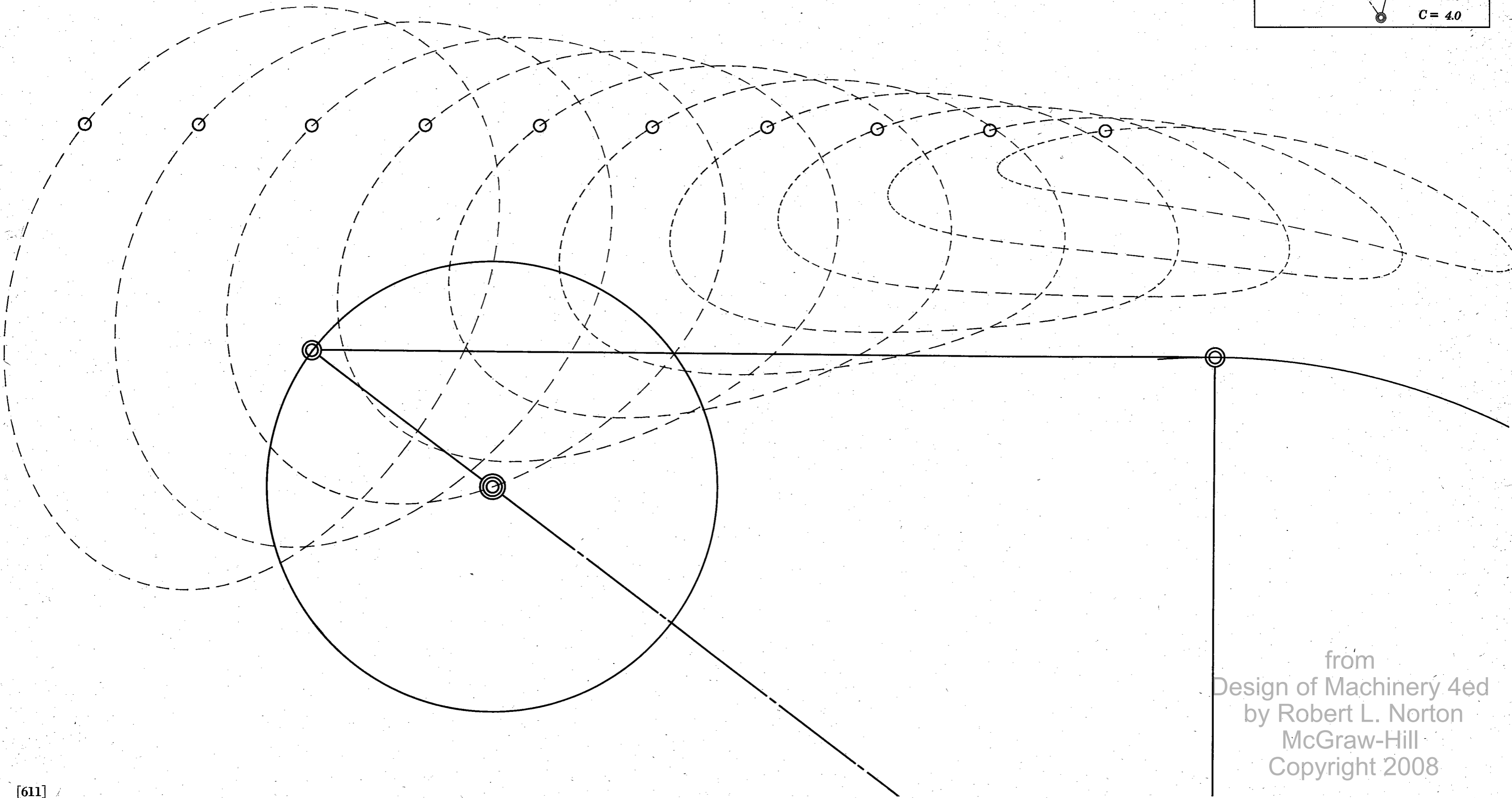
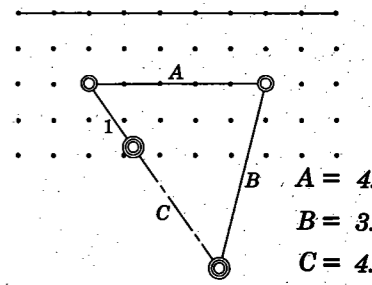

from  
Design of Machinery 4ed  
by Robert L. Norton  
McGraw-Hill  
Copyright 2008



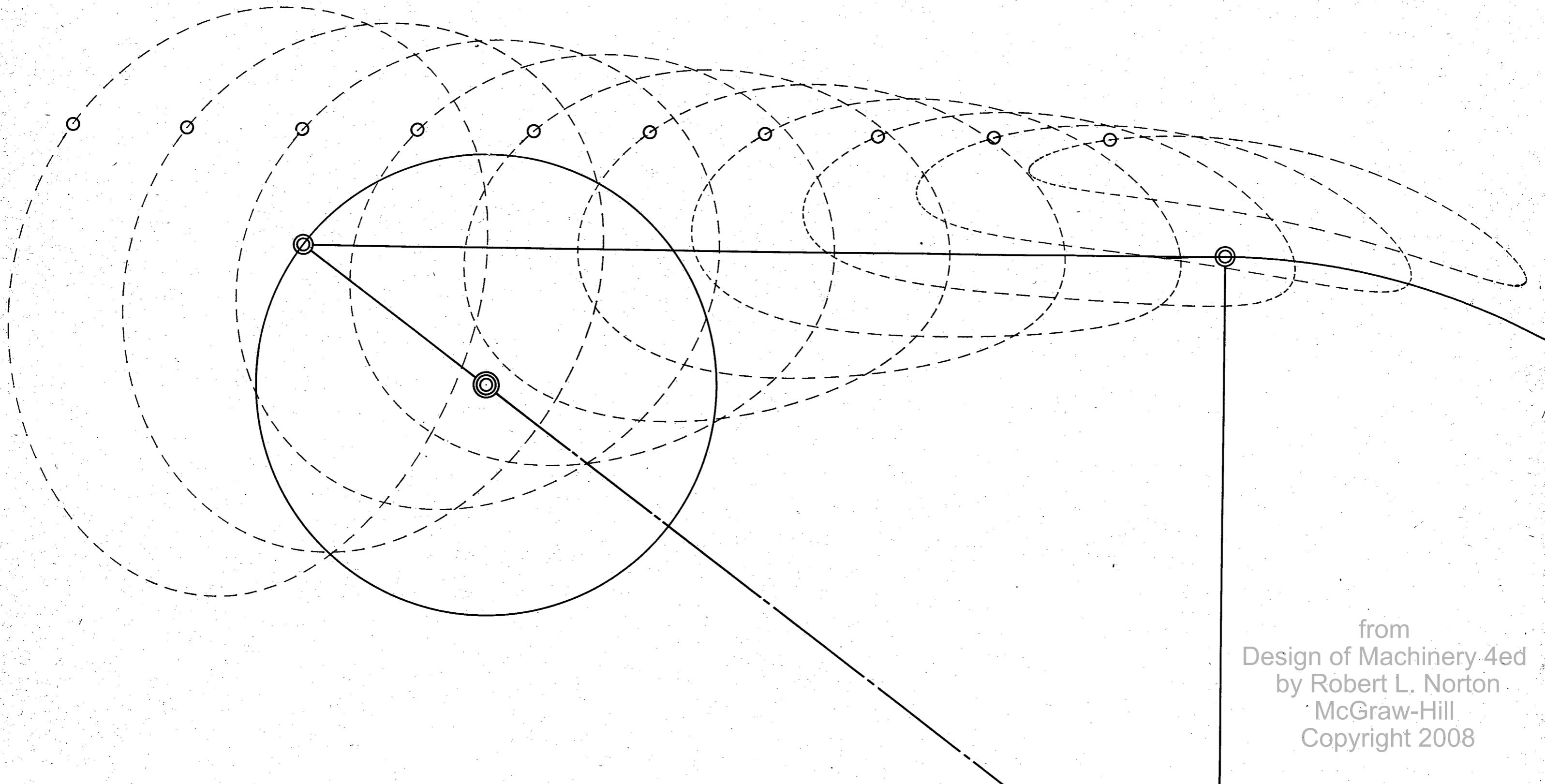
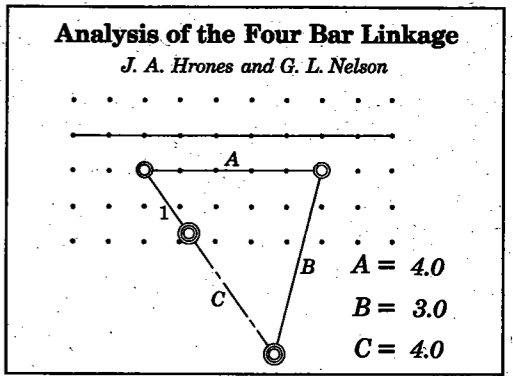

from  
Design of Machinery 4ed  
by Robert L. Norton  
McGraw-Hill  
Copyright 2008

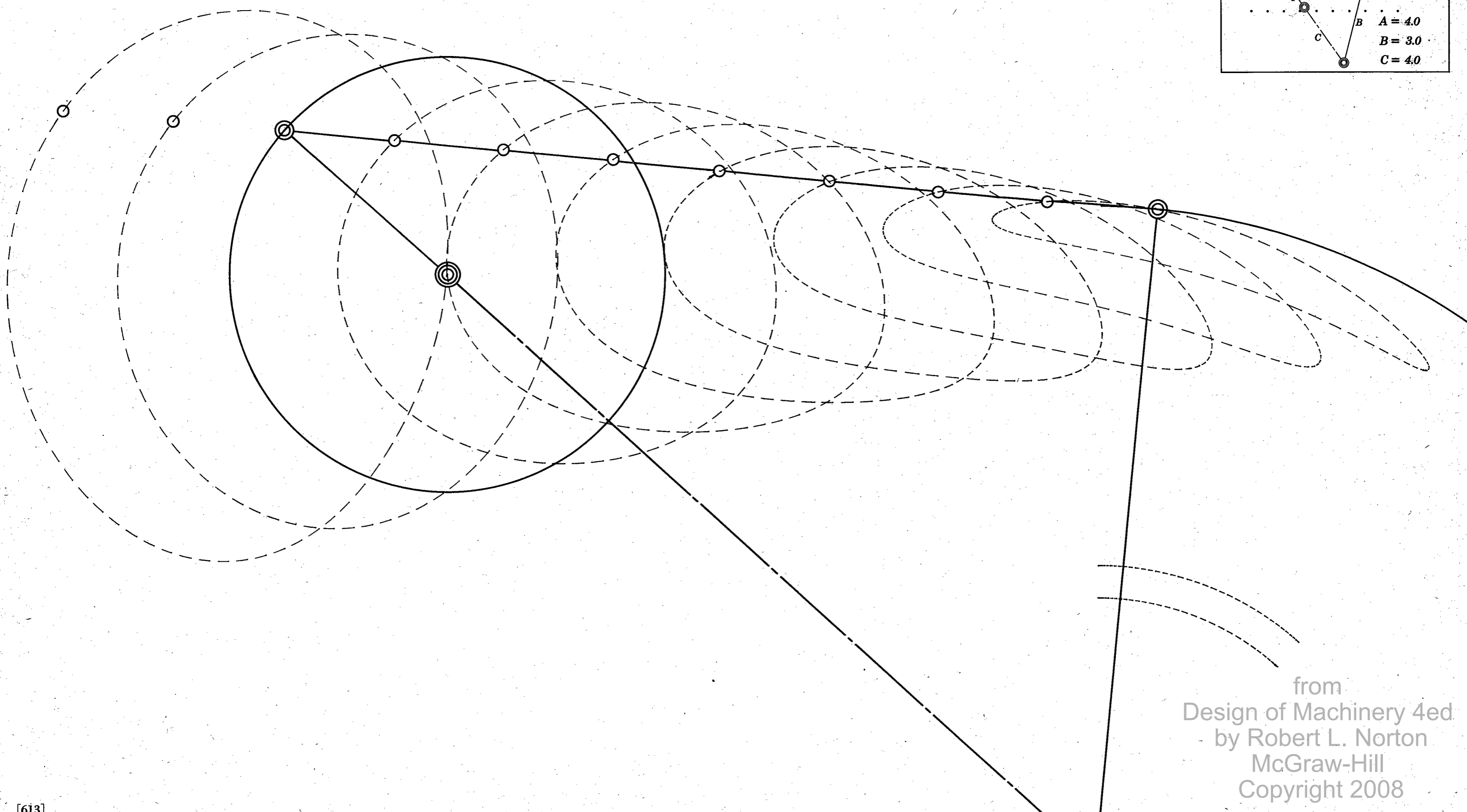
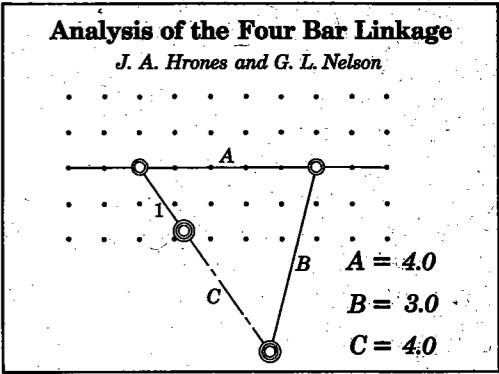

from  
 Design of Machinery 4ed  
 by Robert L. Norton  
 McGraw-Hill  
 Copyright 2008

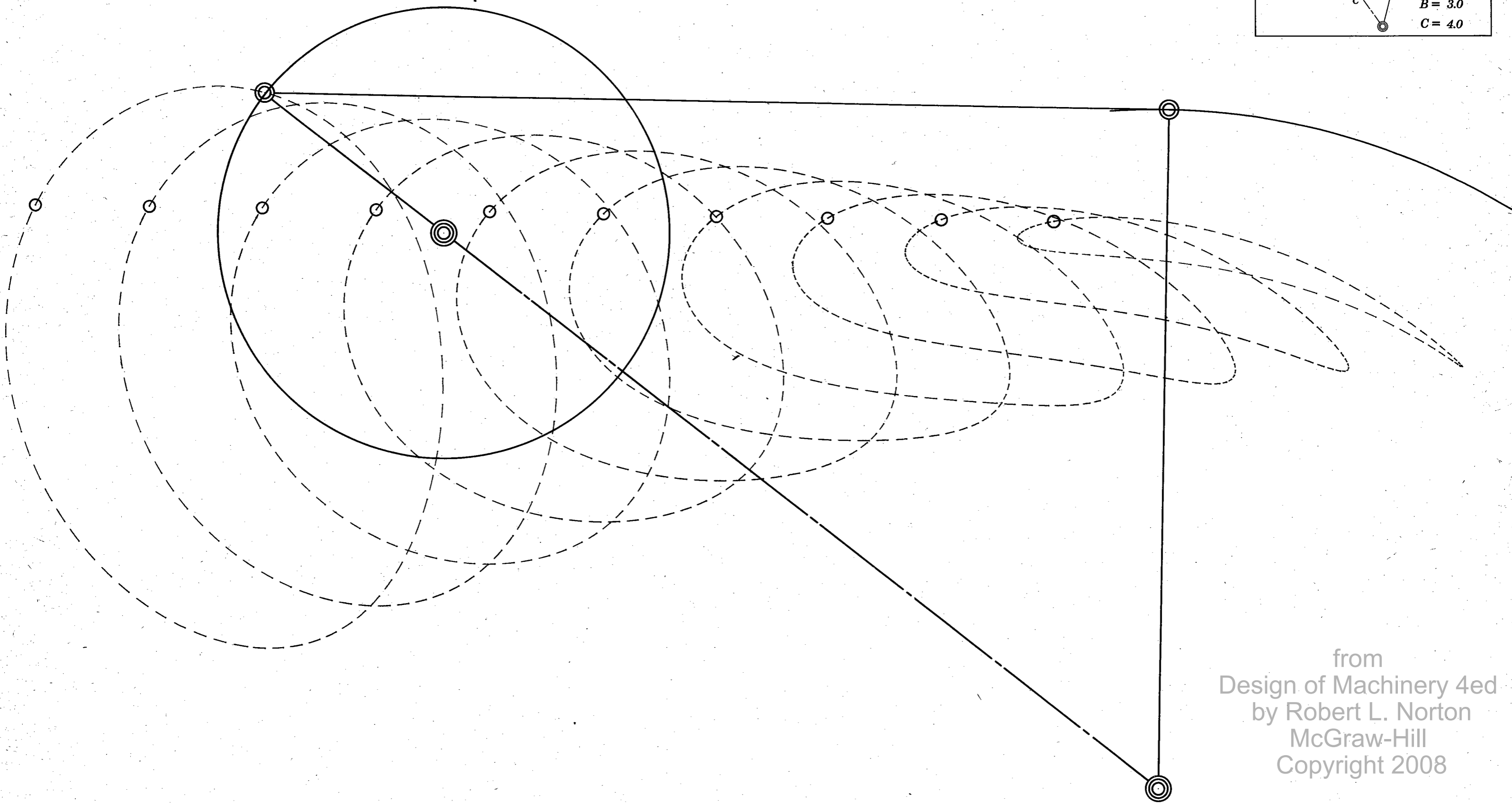
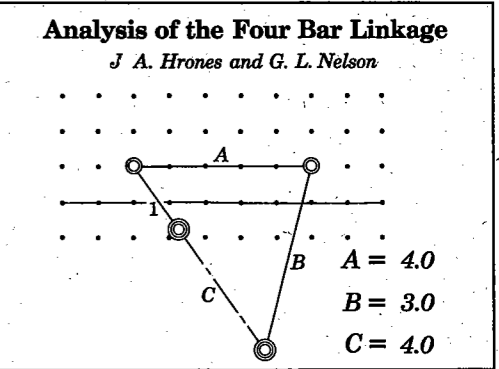

from  
Design of Machinery 4ed  
by Robert L. Norton  
McGraw-Hill  
Copyright 2008

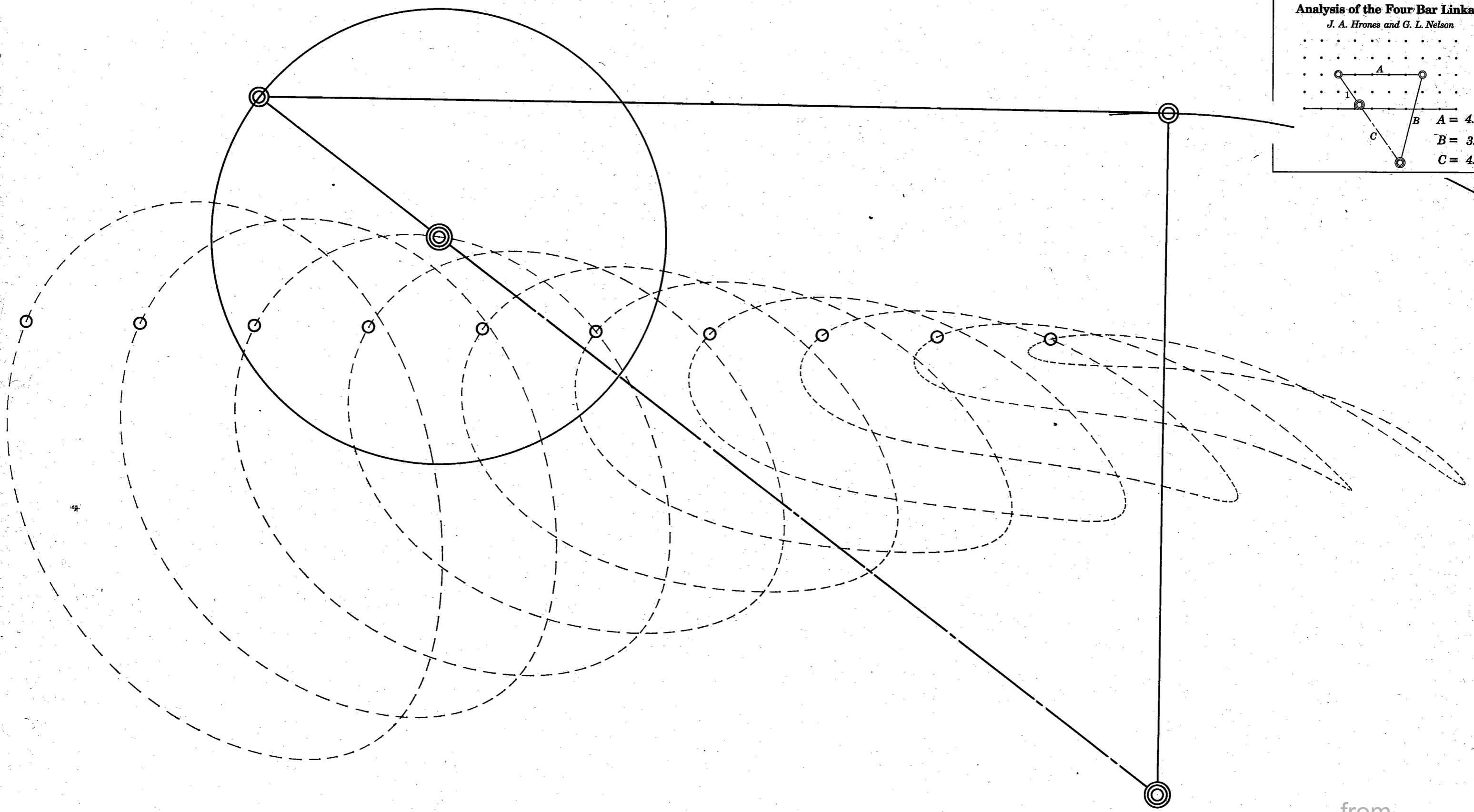
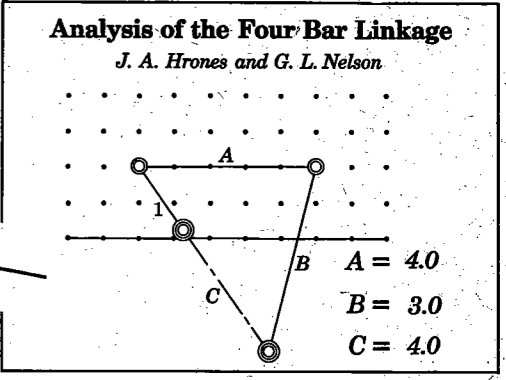

from  
 Design of Machinery 4ed  
 by Robert L. Norton  
 McGraw-Hill  
 Copyright 2008

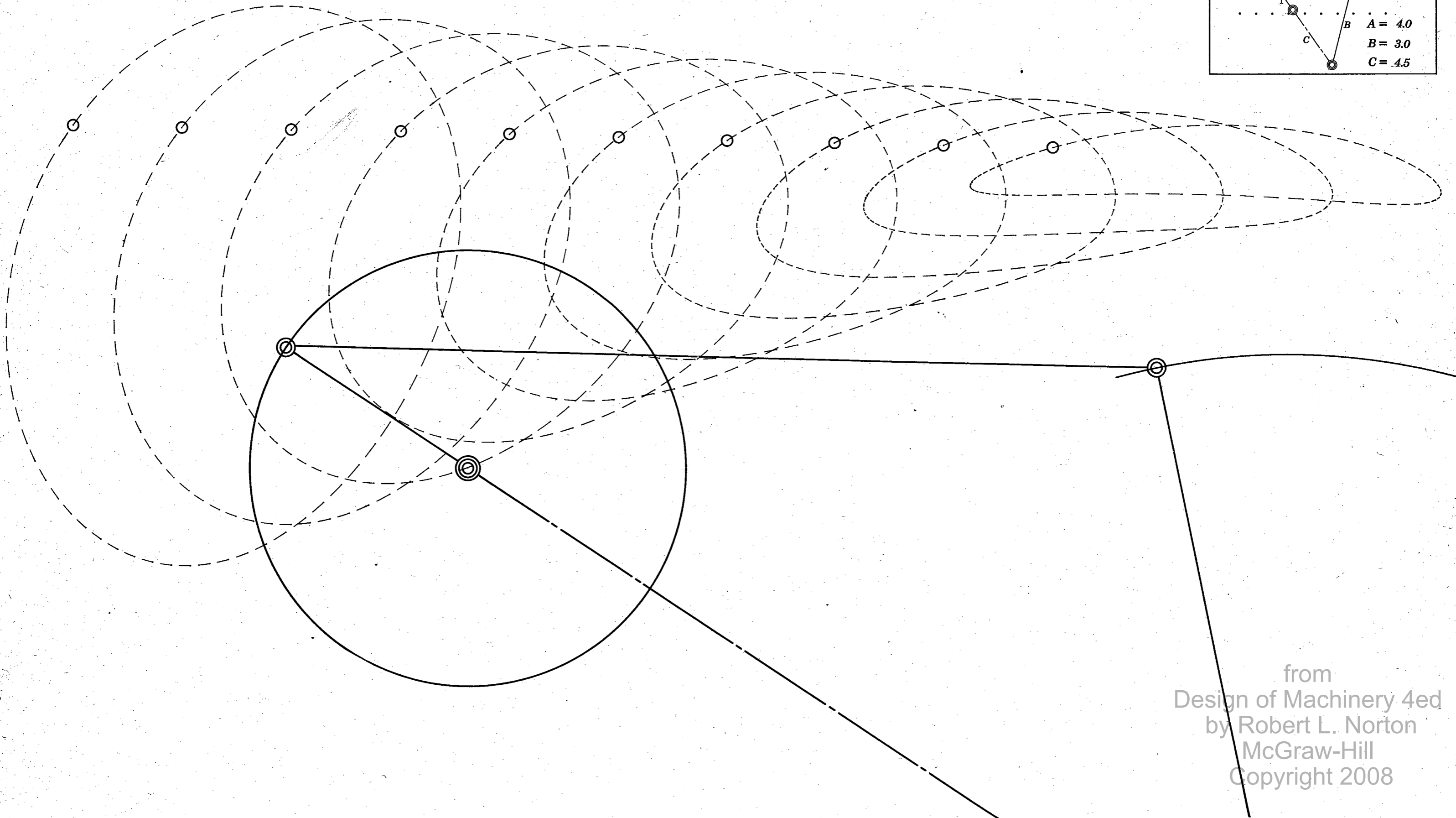
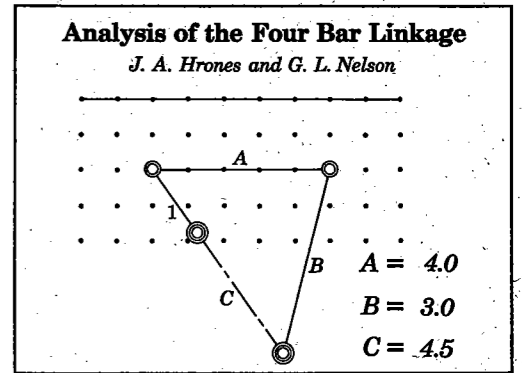

from  
Design of Machinery 4ed  
by Robert L. Norton  
McGraw-Hill  
Copyright 2008

**Analysis of the Four Bar Linkage**  
*J. A. Hrones and G. L. Nelson*

$A = 4.0$   
 $B = 3.0$   
 $C = 4.5$

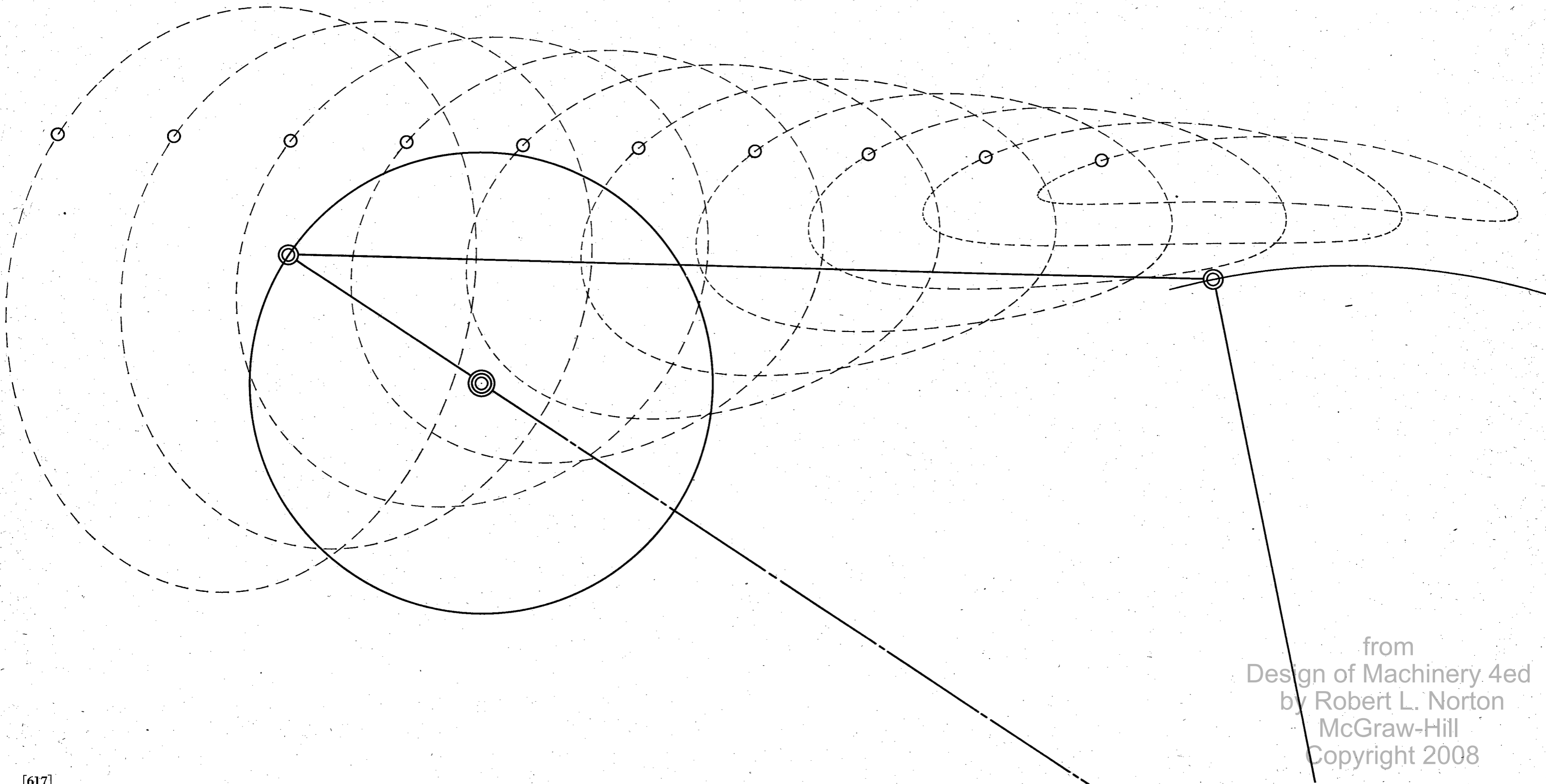

from  
 Design of Machinery 4ed  
 by Robert L. Norton  
 McGraw-Hill  
 Copyright 2008

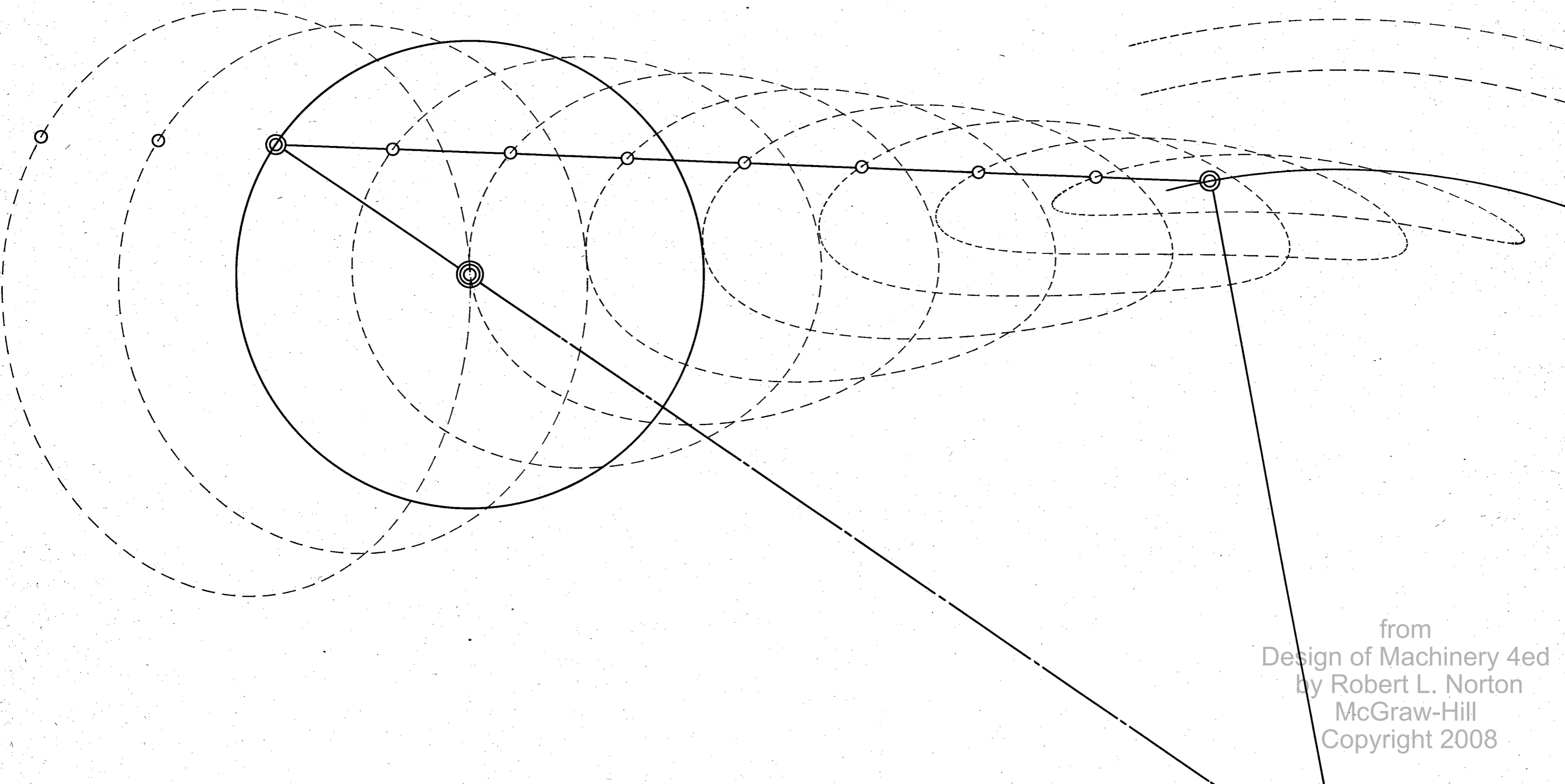
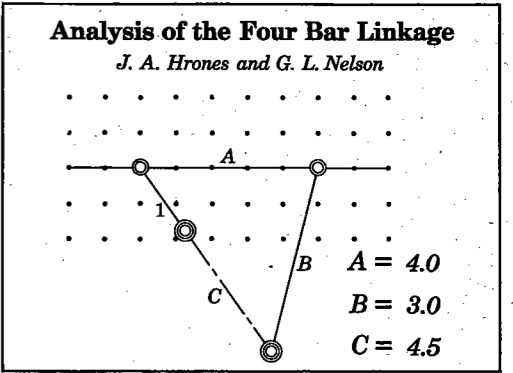

from  
Design of Machinery 4ed  
by Robert L. Norton  
McGraw-Hill  
Copyright 2008

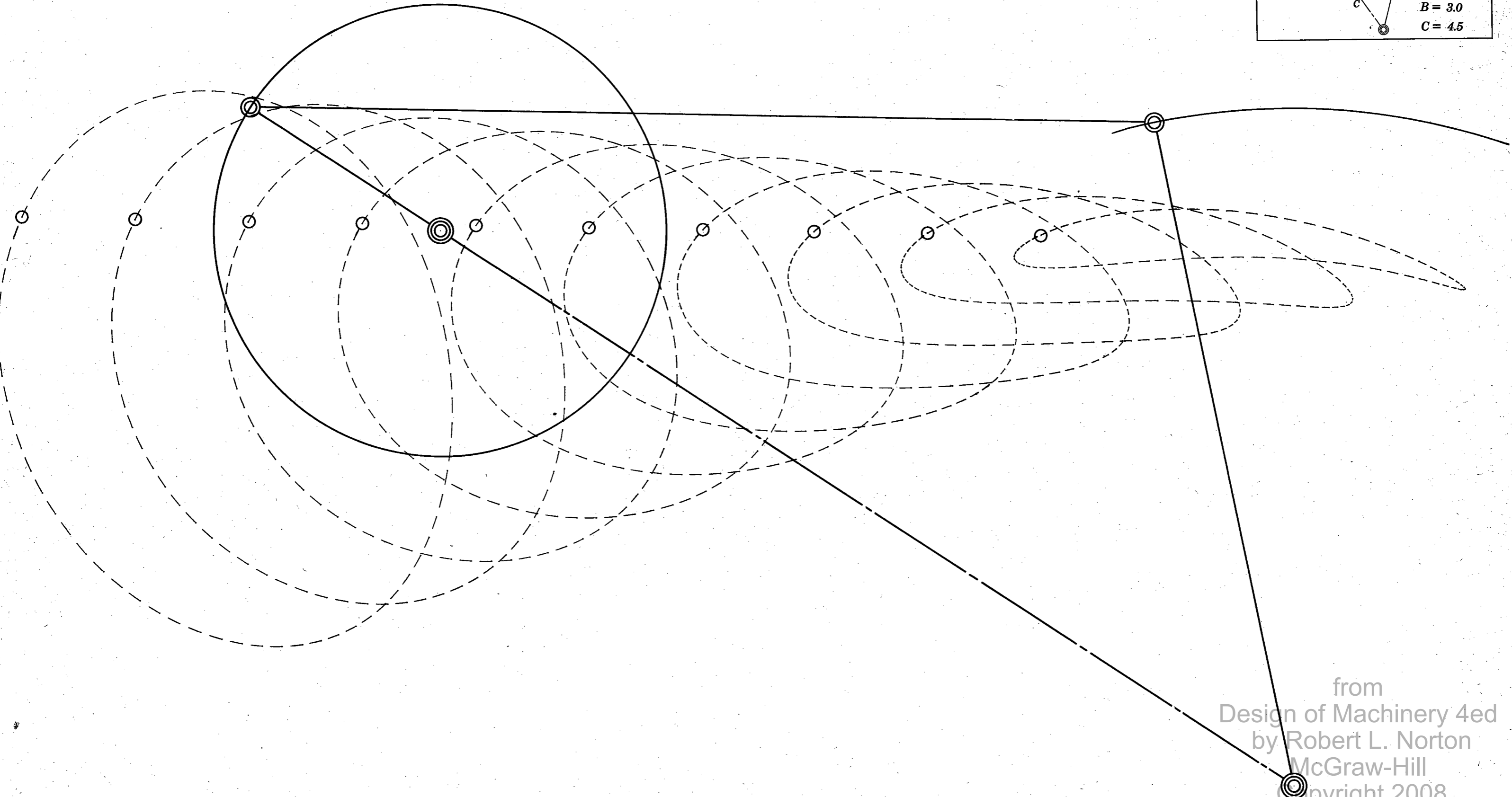
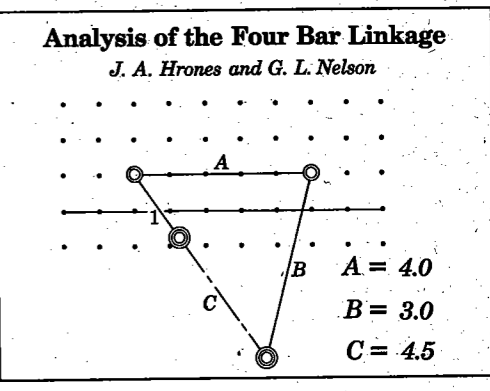

from  
 Design of Machinery 4ed  
 by Robert L. Norton  
 McGraw-Hill  
 Copyright 2008



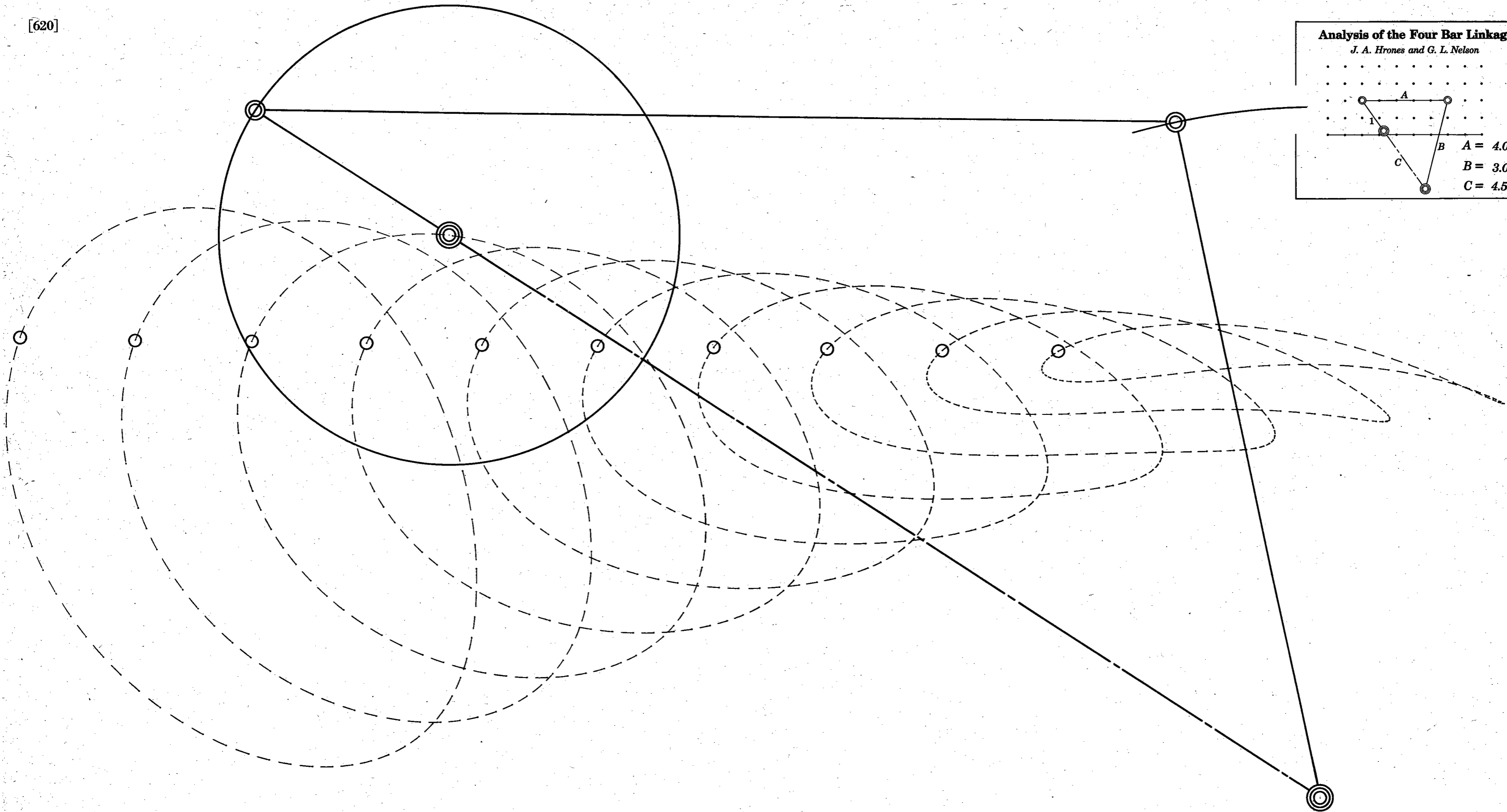
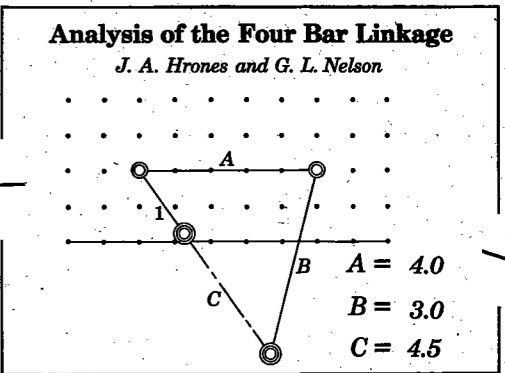

from  
Design of Machinery 4ed  
by Robert L. Norton  
McGraw-Hill  
Copyright 2008

**Analysis of the Four Bar Linkage**  
*J. A. Hrones and G. L. Nelson*

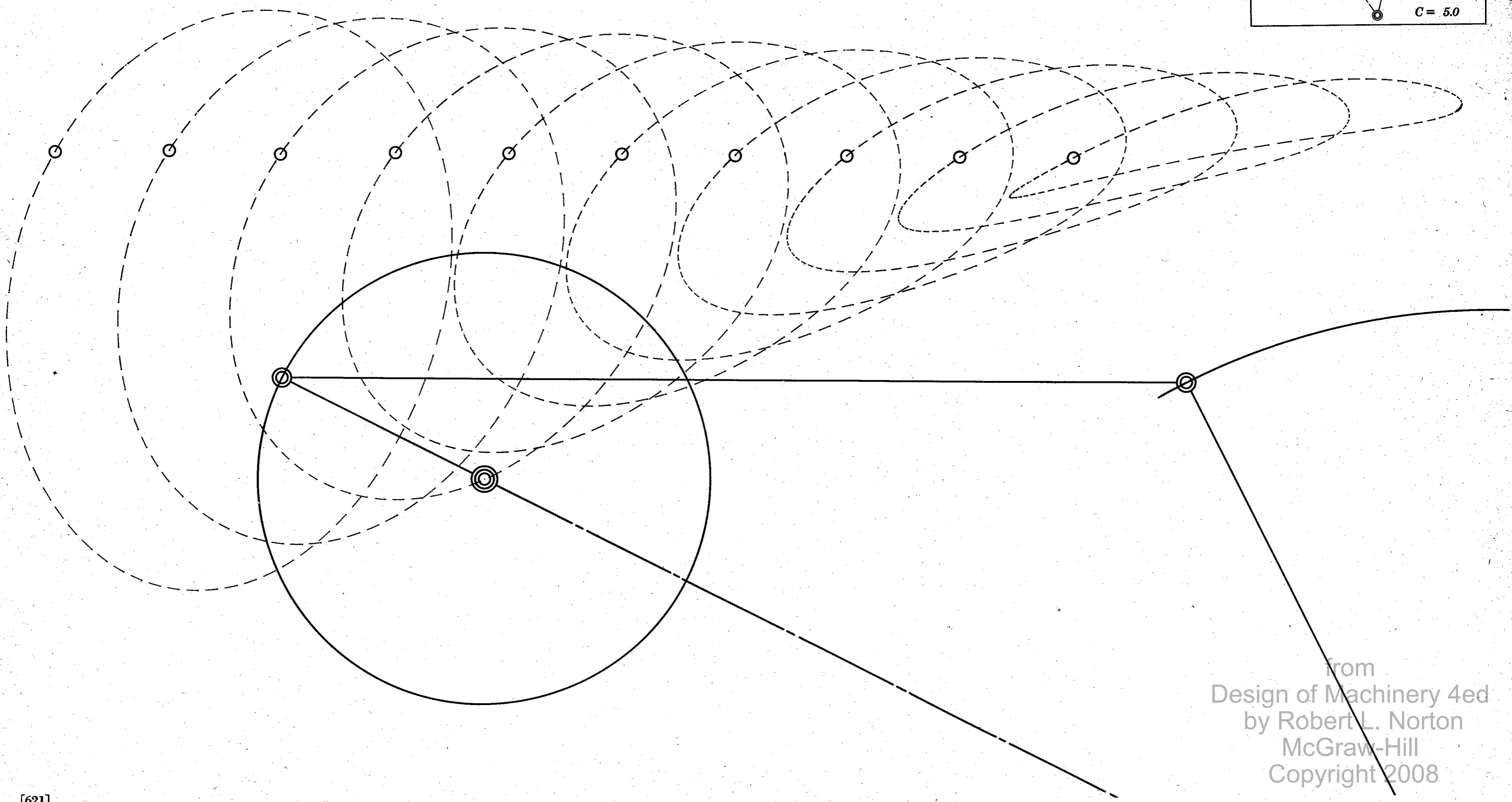
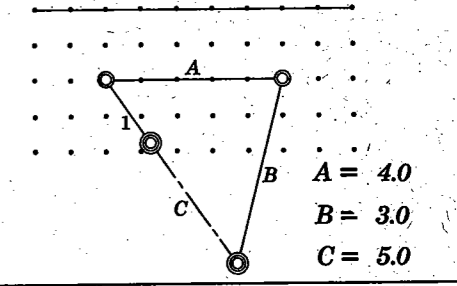

from  
Design of Machinery 4ed  
by Robert L. Norton  
McGraw-Hill  
Copyright 2008

**Analysis of the Four Bar Linkage**  
*J. A. Hrones and G. L. Nelson*

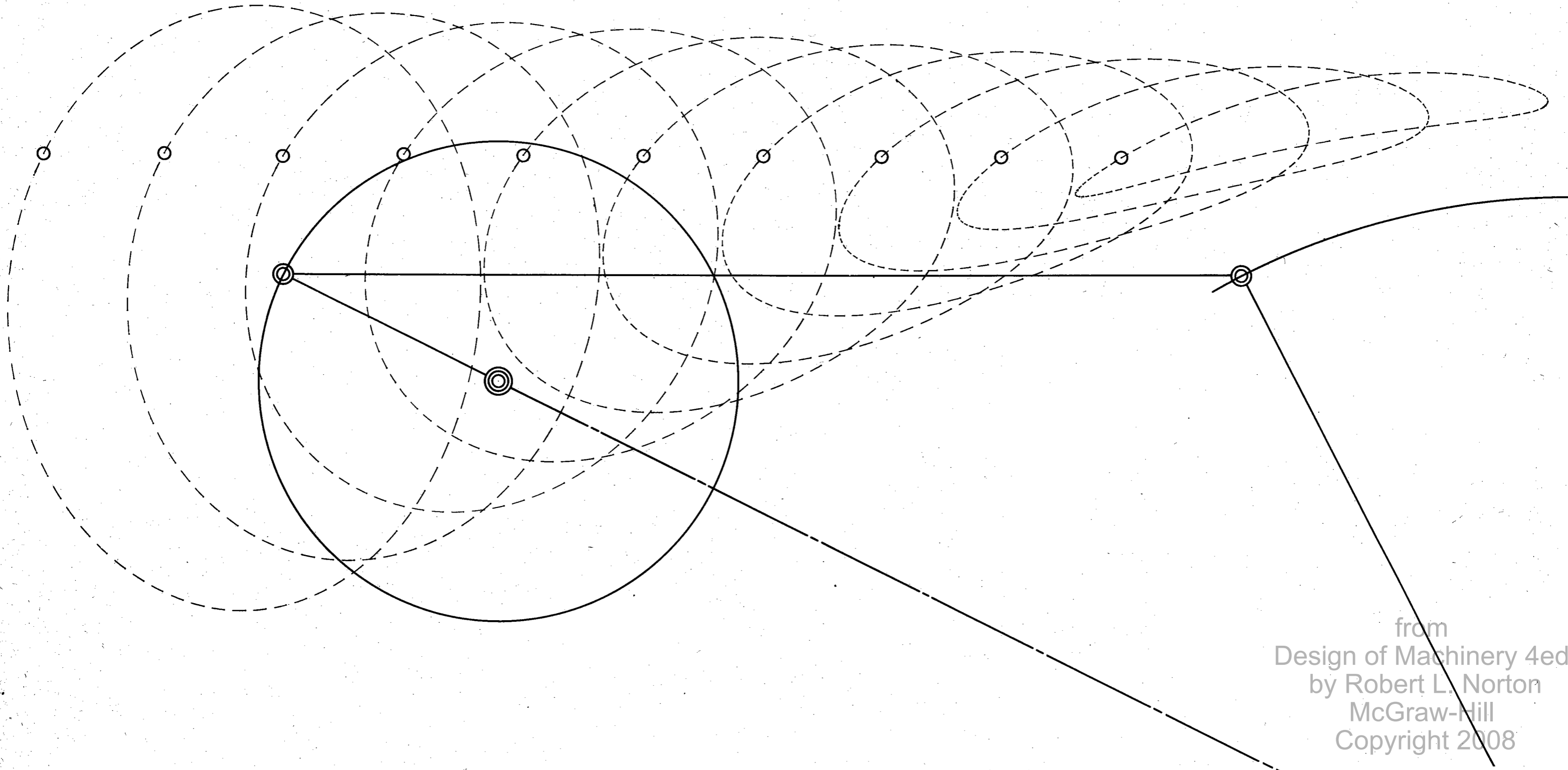
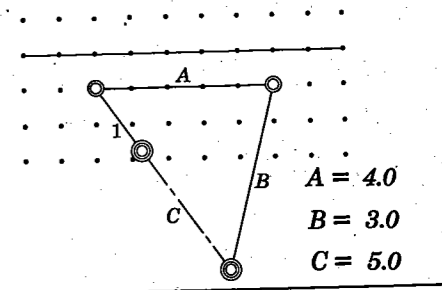

from  
Design of Machinery 4ed  
by Robert L. Norton  
McGraw-Hill  
Copyright 2008

**Analysis of the Four Bar Linkage**

*J. A. Hrones and G. L. Nelson*

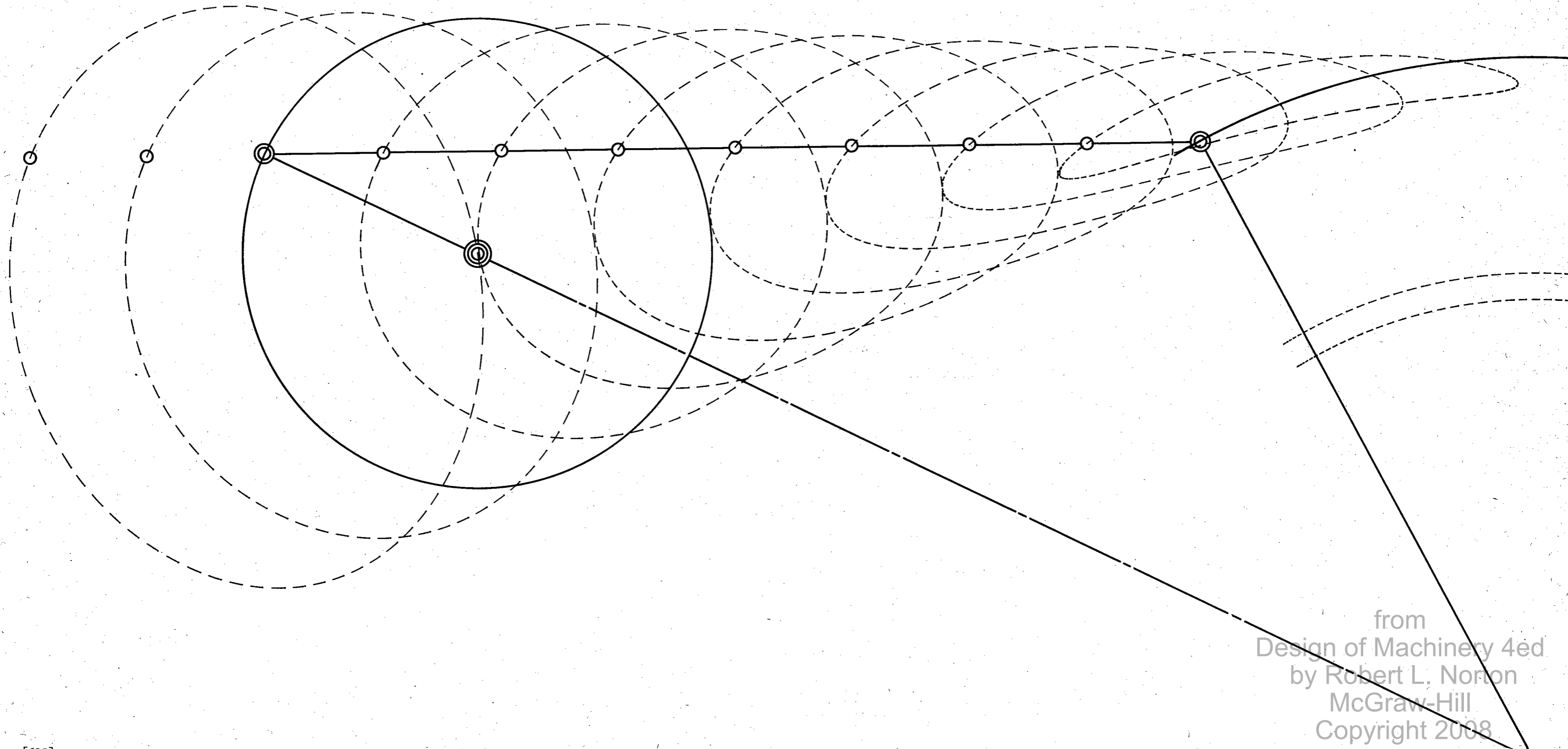
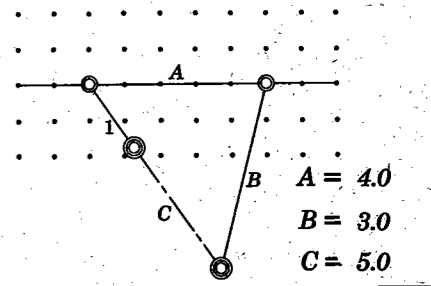

from  
Design of Machinery 4ed  
by Robert L. Norton  
McGraw-Hill  
Copyright 2008

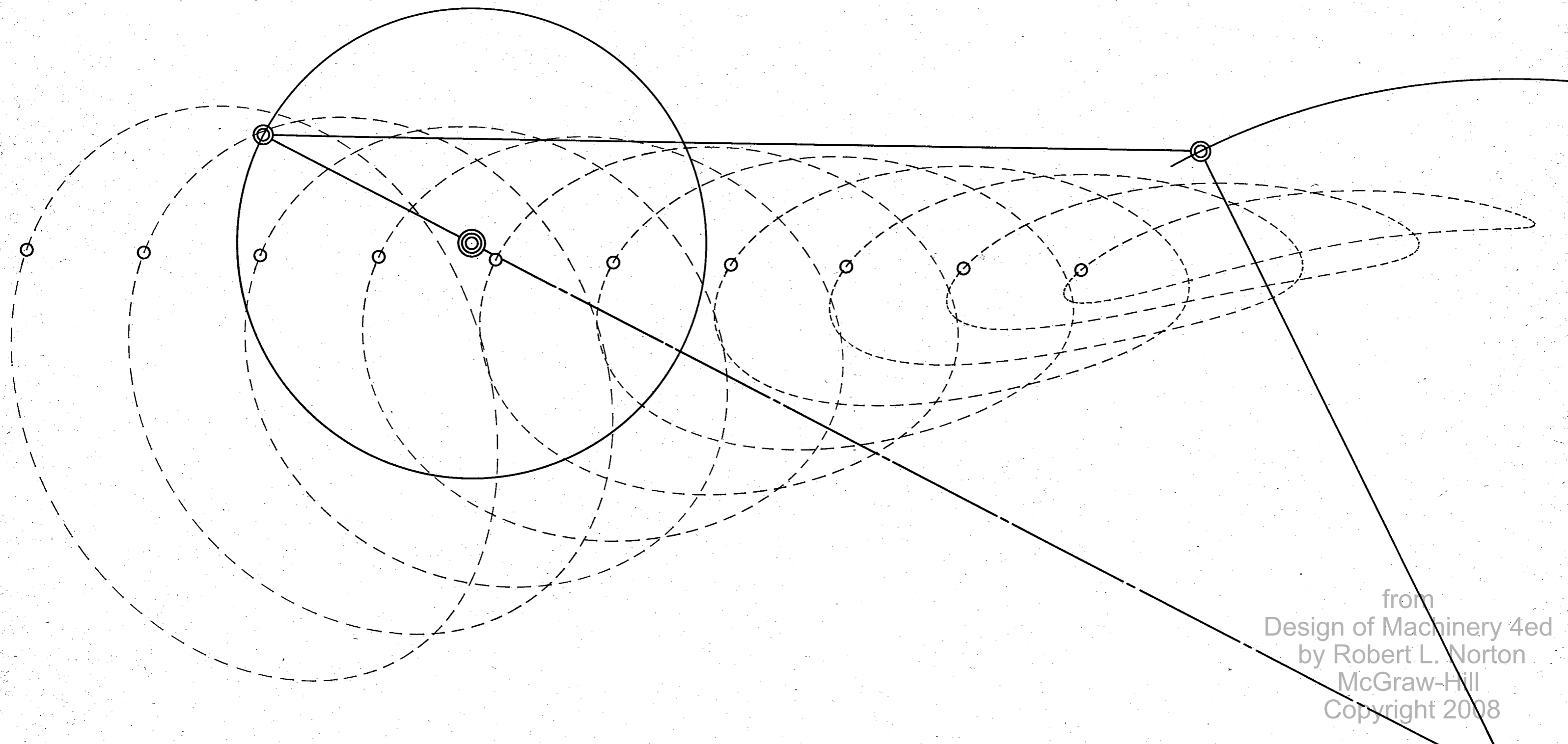
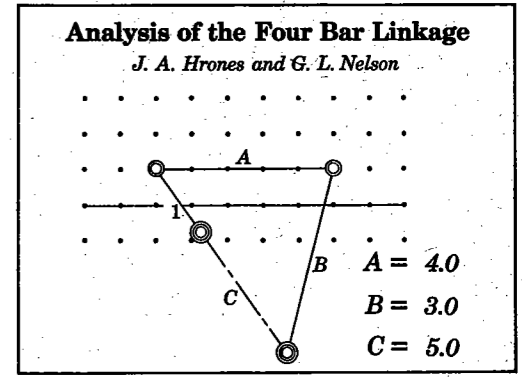

from  
Design of Machinery 4ed  
by Robert L. Norton  
McGraw-Hill  
Copyright 2008

**Analysis of the Four Bar Linkage**

*J. A. Hrones and G. L. Nelson*

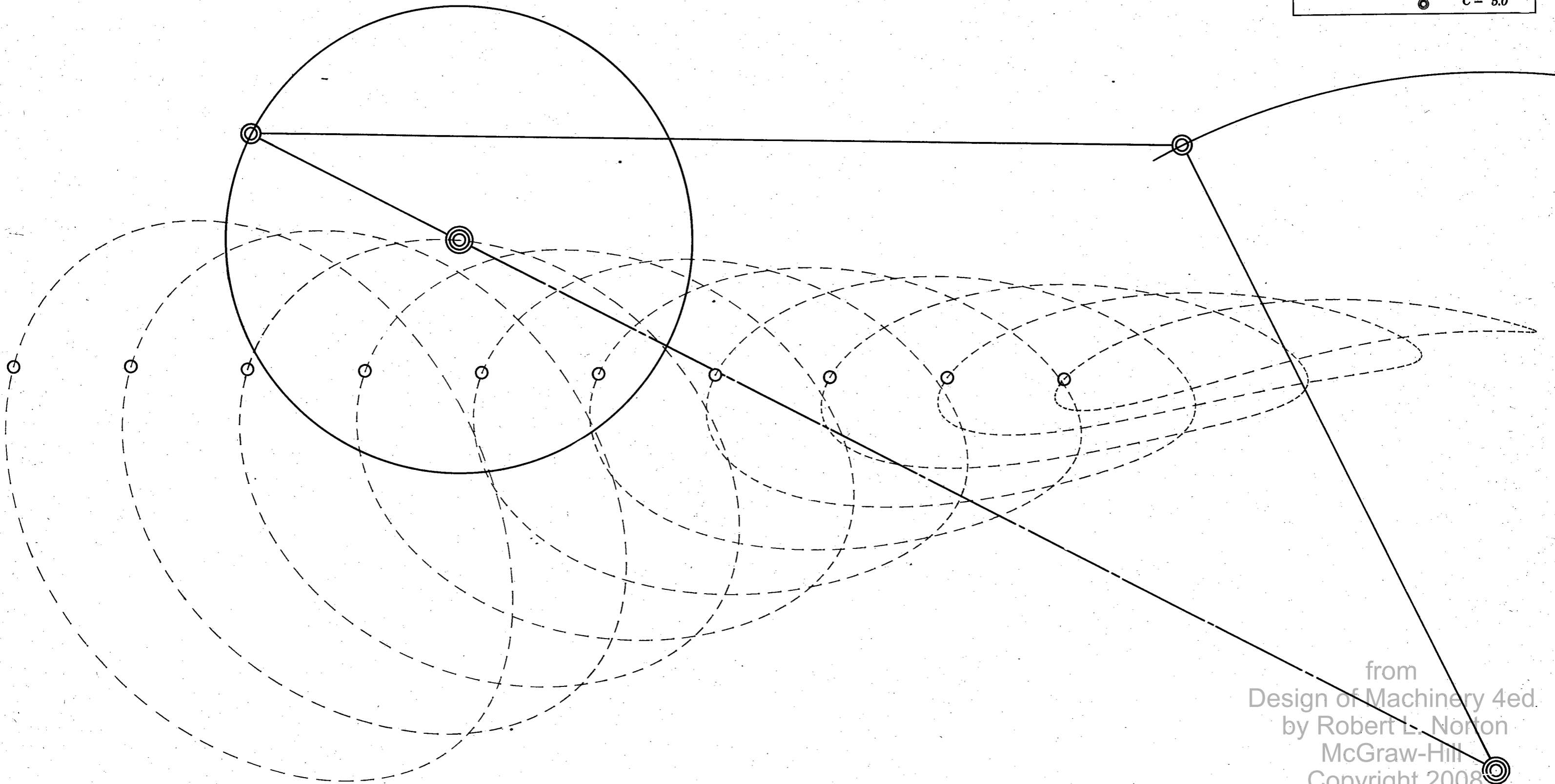
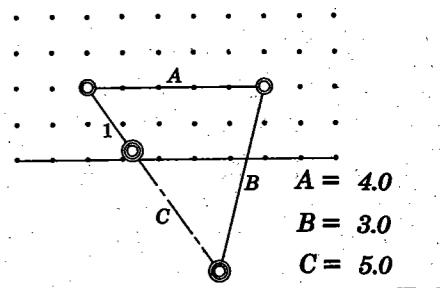

from  
Design of Machinery 4ed.  
by Robert L. Norton  
McGraw-Hill  
Copyright 2008

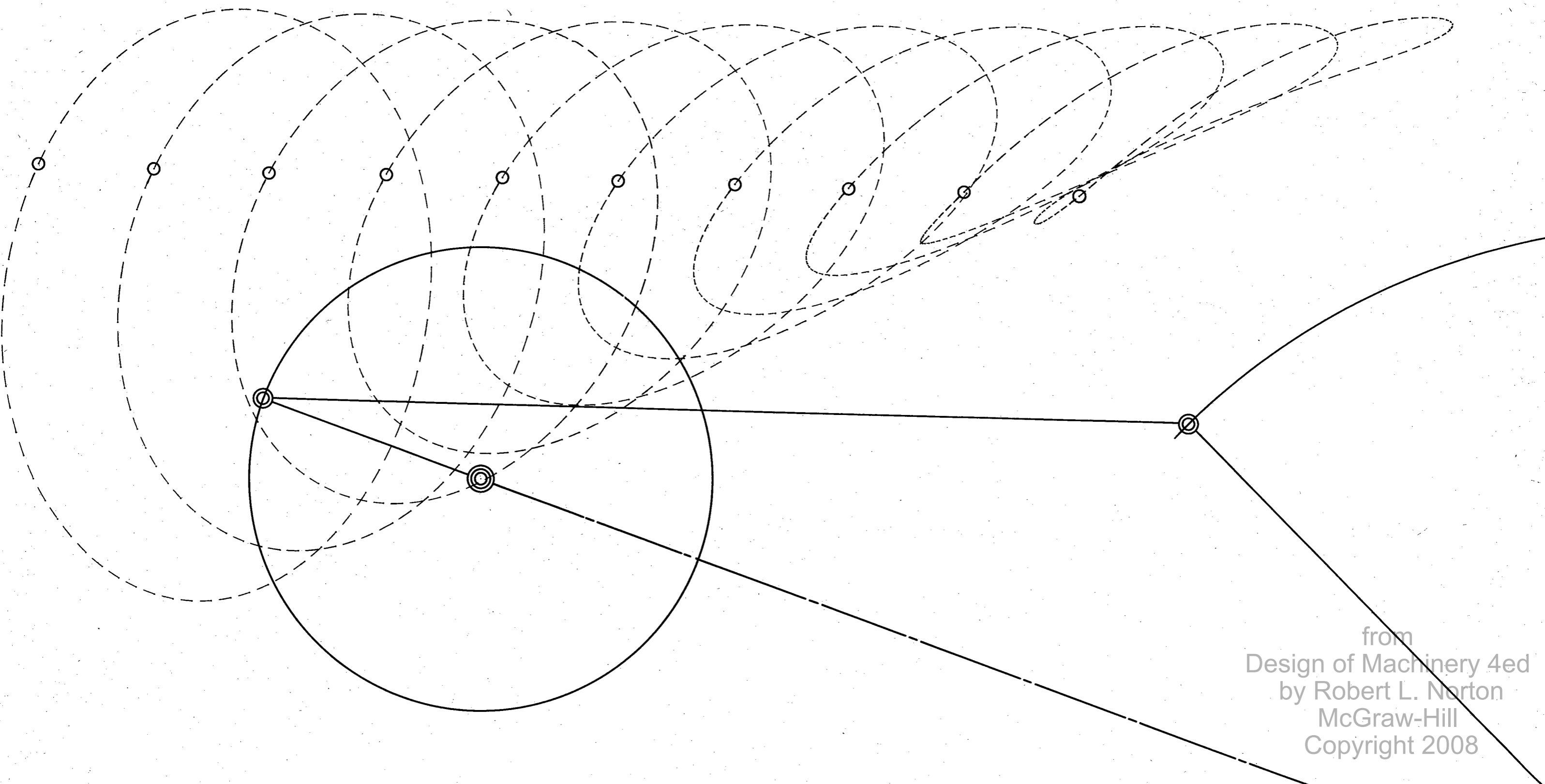
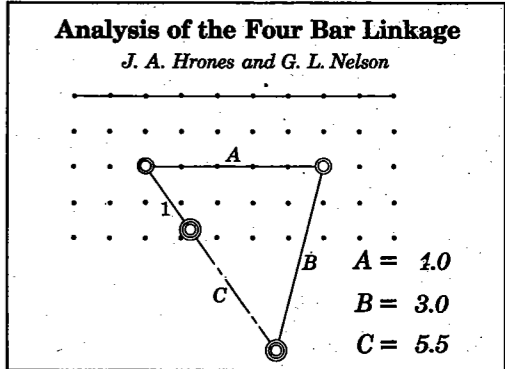

from  
Design of Machinery 4ed  
by Robert L. Norton  
McGraw-Hill  
Copyright 2008

**Analysis of the Four Bar Linkage**

*J. A. Hrones and G. L. Nelson*

.....

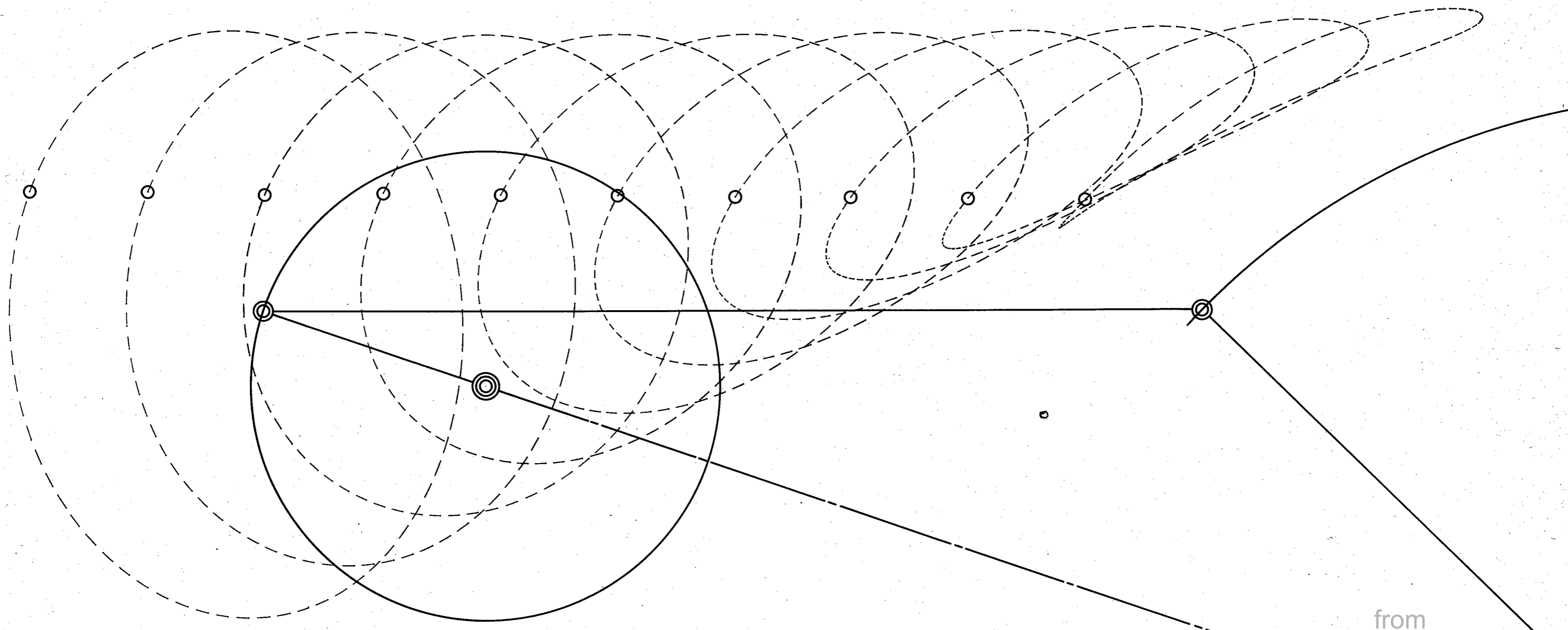
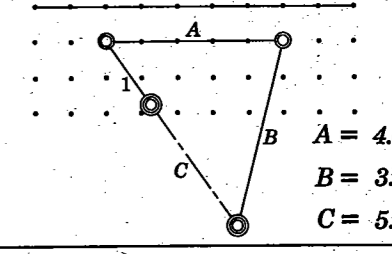

from  
Design of Machinery 4ed  
by Robert L. Norton  
McGraw Hill  
Copyright 2008



**Analysis of the Four Bar Linkage**  
*J. A. Hrones and G. L. Nelson*

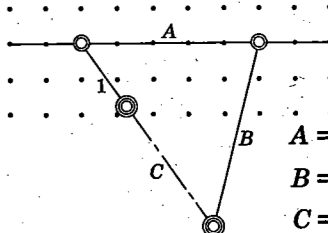

$A = 4.0$   
 $B = 3.0$   
 $C = 5.5$

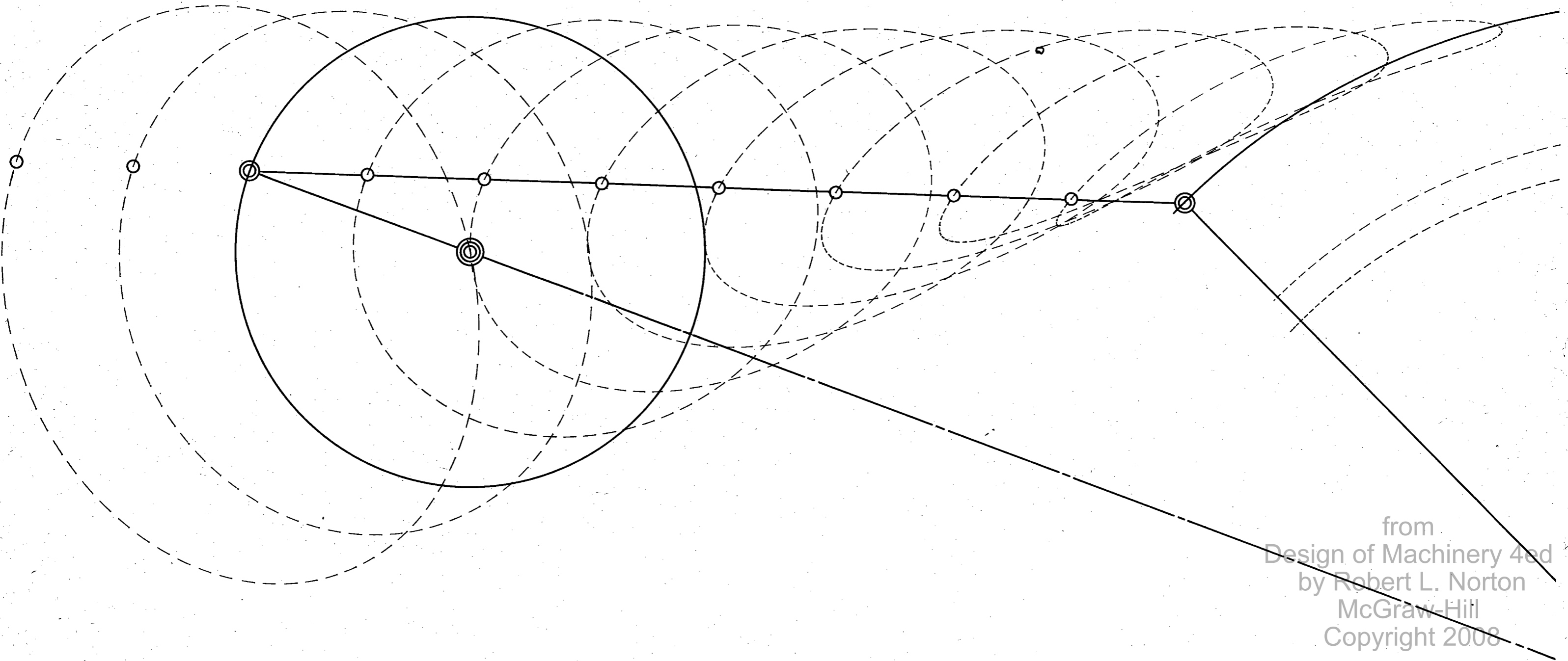

from  
Design of Machinery 4ed  
by Robert L. Norton  
McGraw-Hill  
Copyright 2008

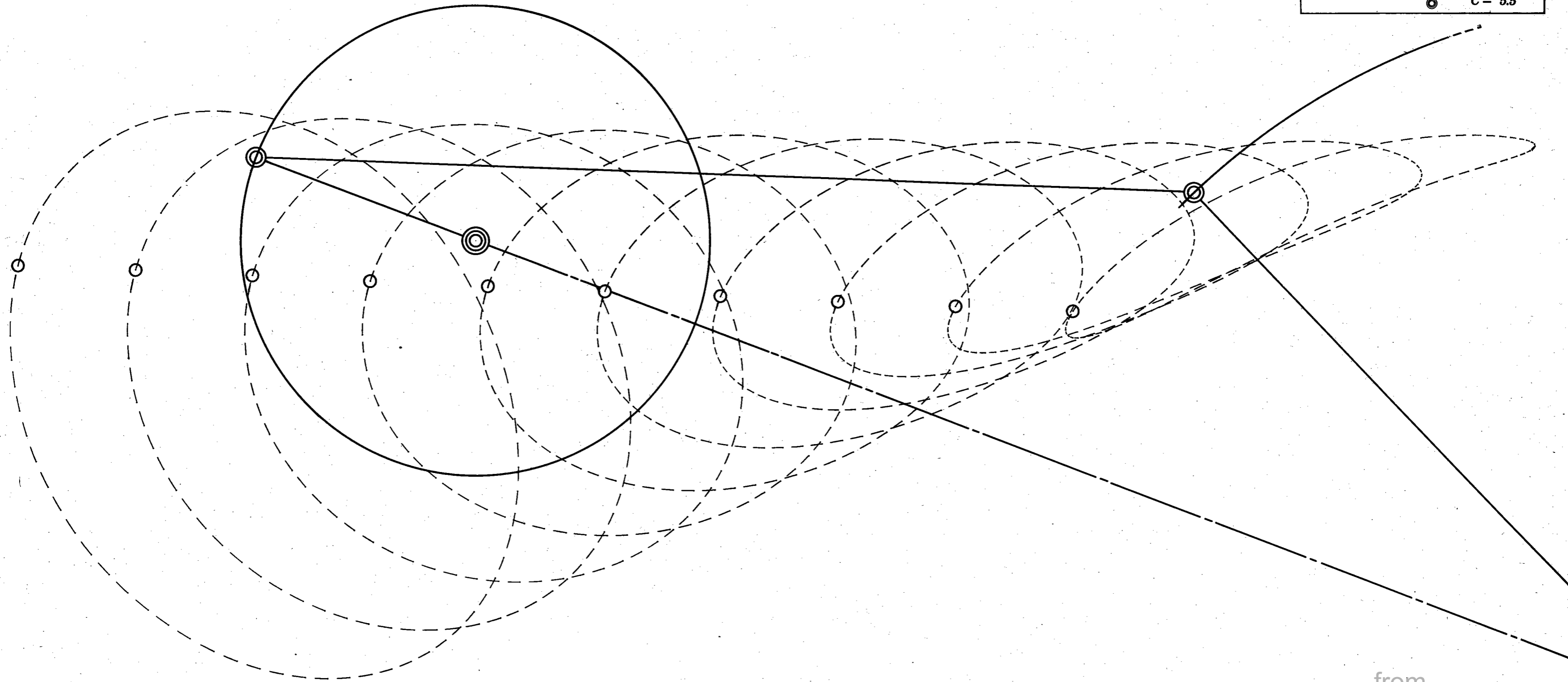
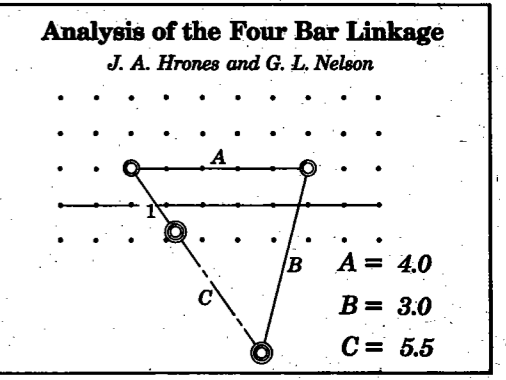

from  
 Design of Machinery 4ed  
 by Robert L. Norton  
 McGraw-Hill  
 Copyright 2008

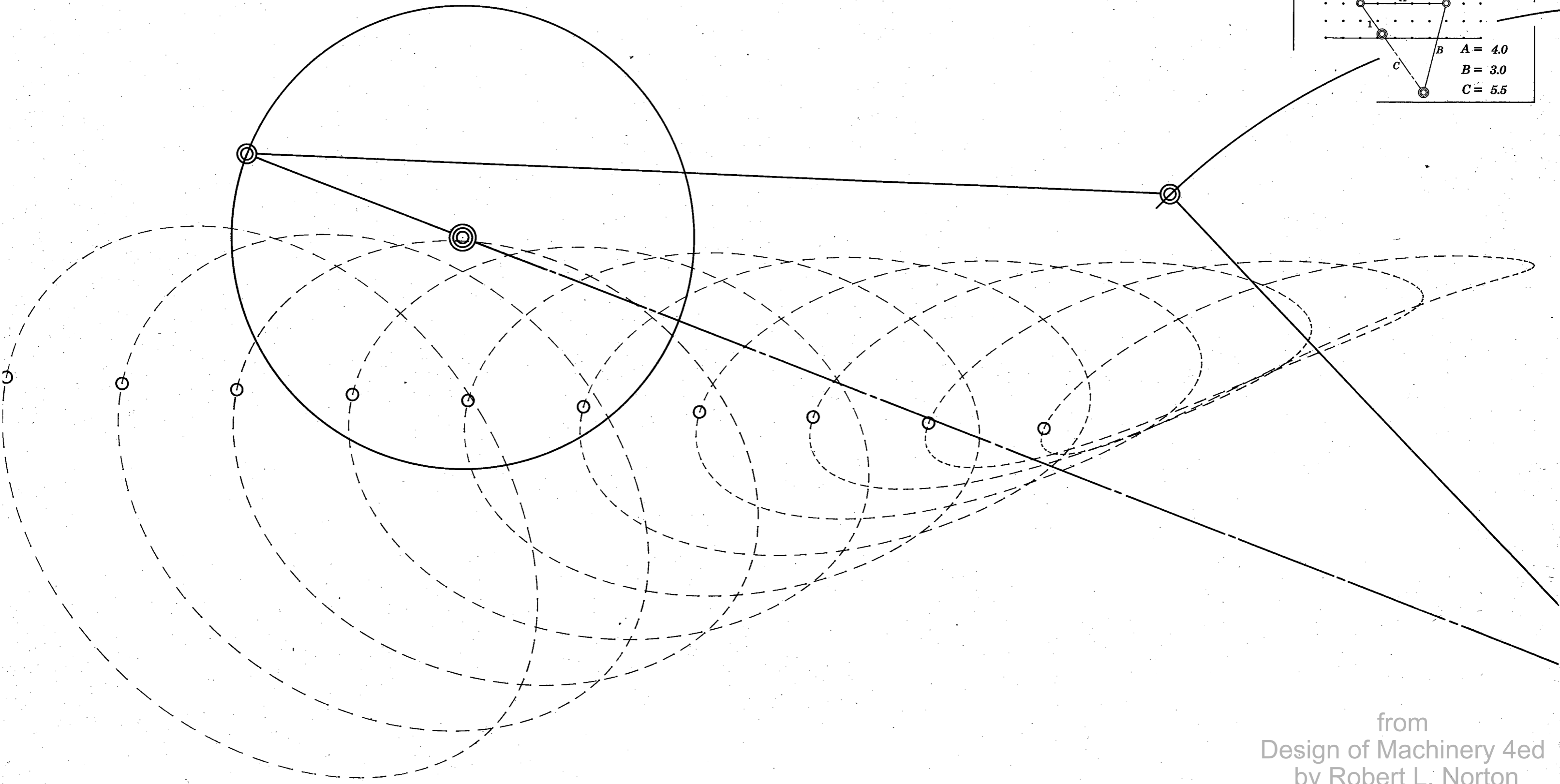
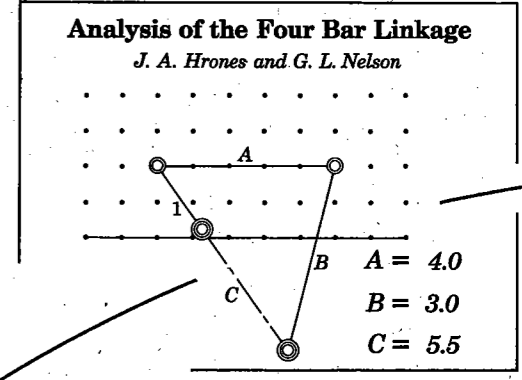

from  
Design of Machinery 4ed  
by Robert L. Norton  
McGraw-Hill  
Copyright 2008

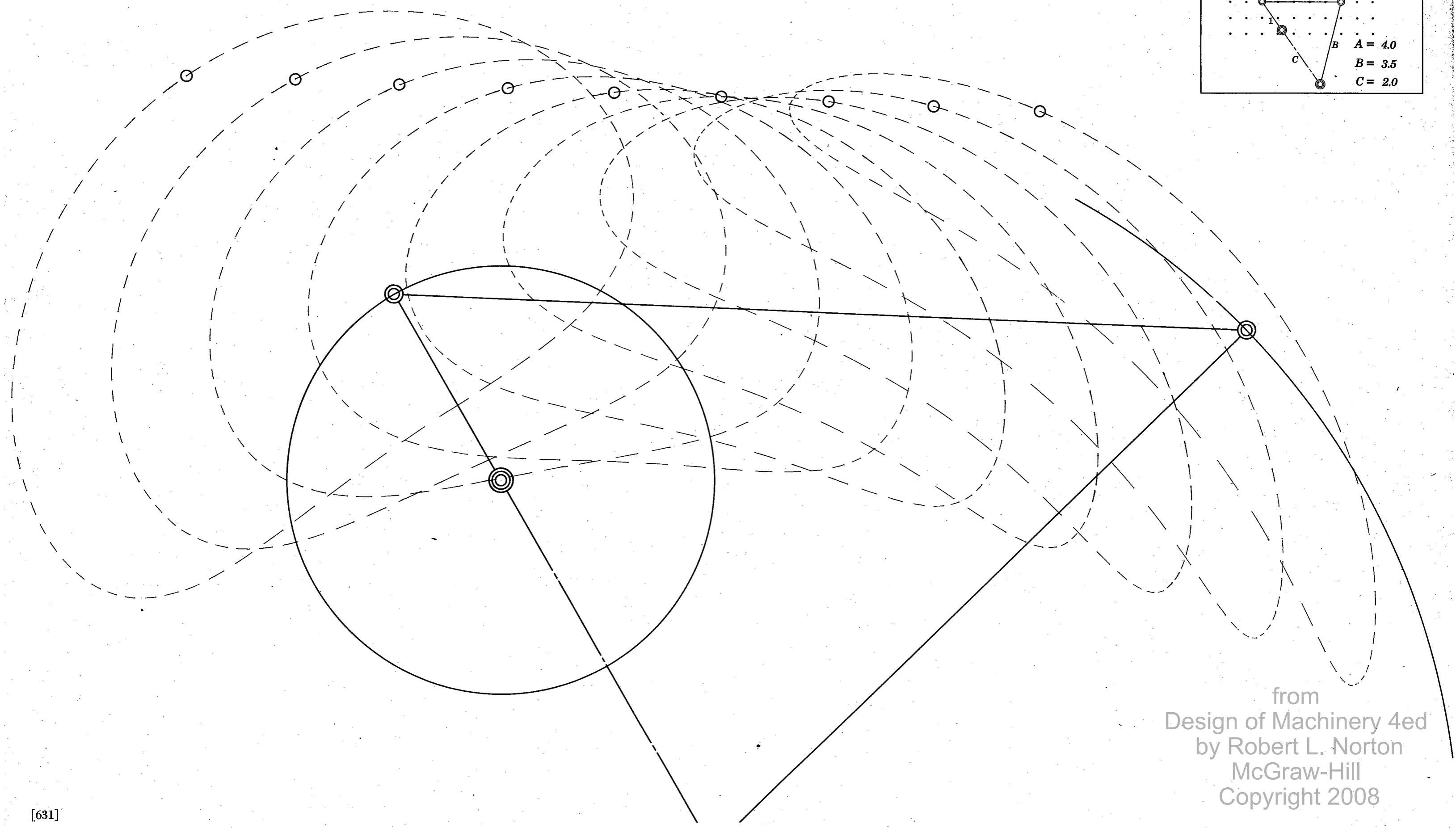
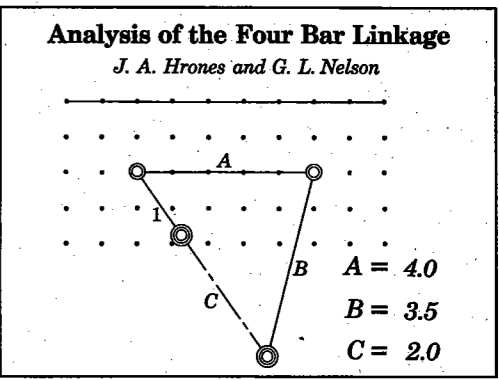

from  
 Design of Machinery 4ed  
 by Robert L. Norton  
 McGraw-Hill  
 Copyright 2008

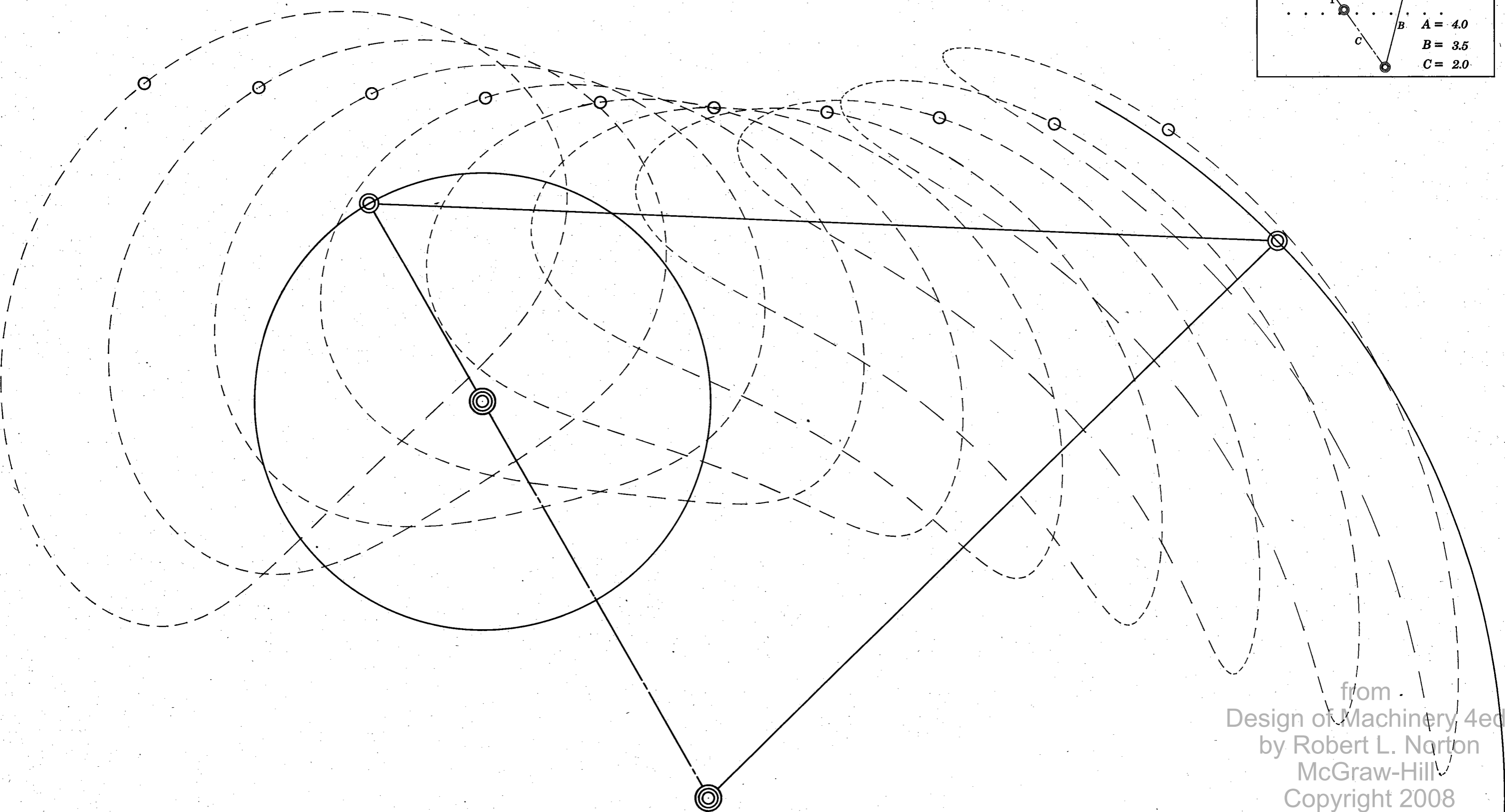
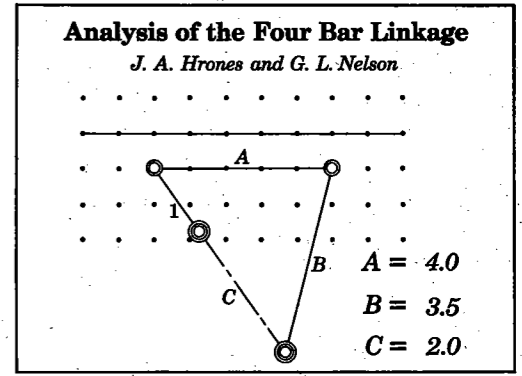

from  
Design of Machinery, 4ed  
by Robert L. Norton  
McGraw-Hill  
Copyright 2008

**Analysis of the Four Bar Linkage**

*J. A. Hrones and G. L. Nelson*

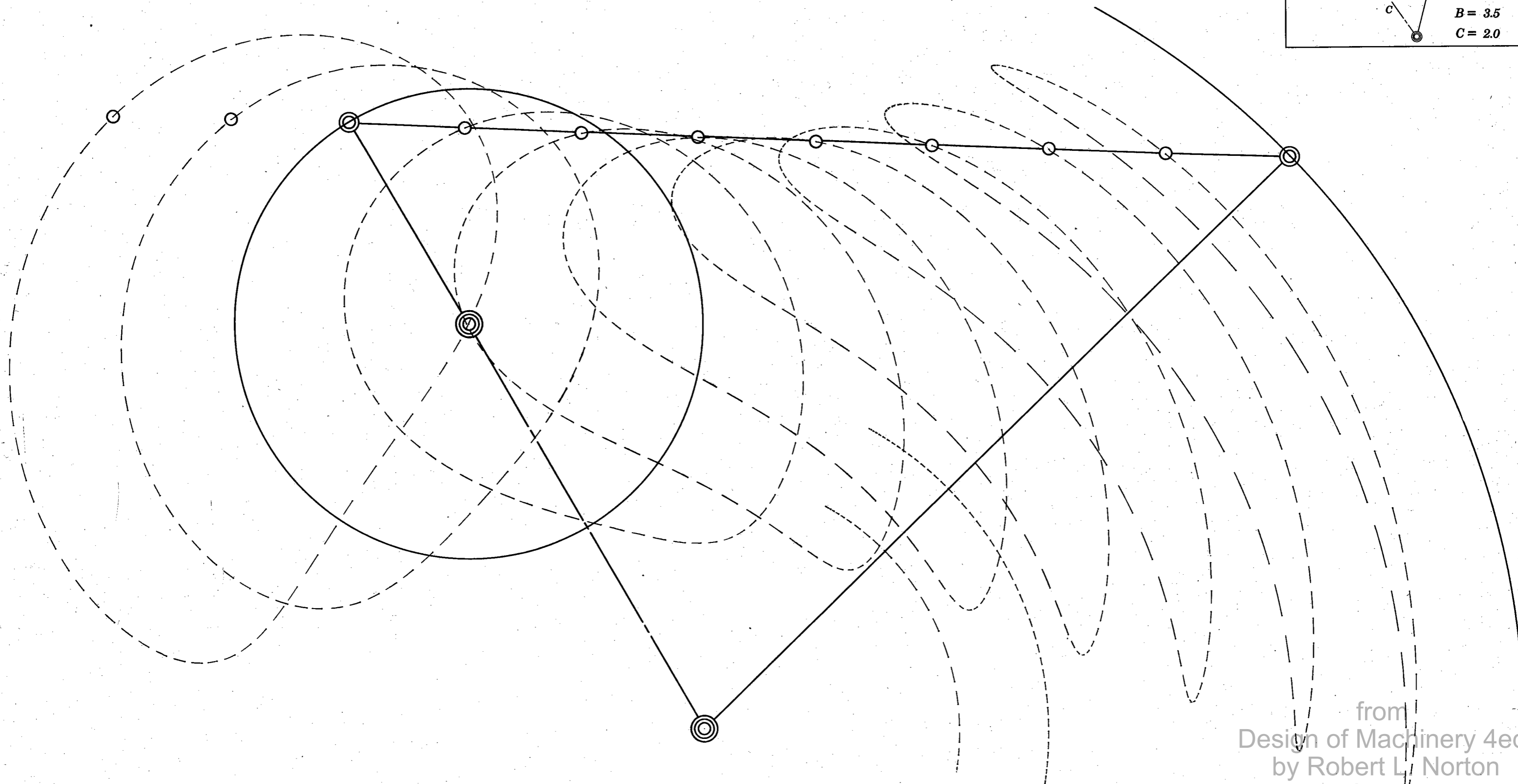
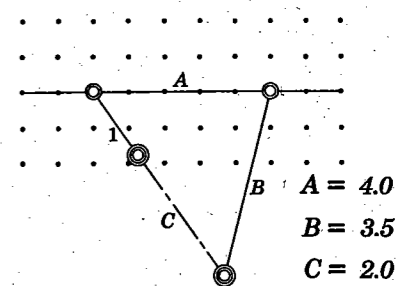

from  
Design of Machinery 4ed  
by Robert L. Norton  
McGraw-Hill  
Copyright 2008

**Analysis of the Four Bar Linkage**  
*J. A. Hrones and G. L. Nelson*

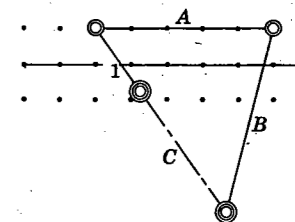

$A = 4.0$   
 $B = 3.5$   
 $C = 2.0$

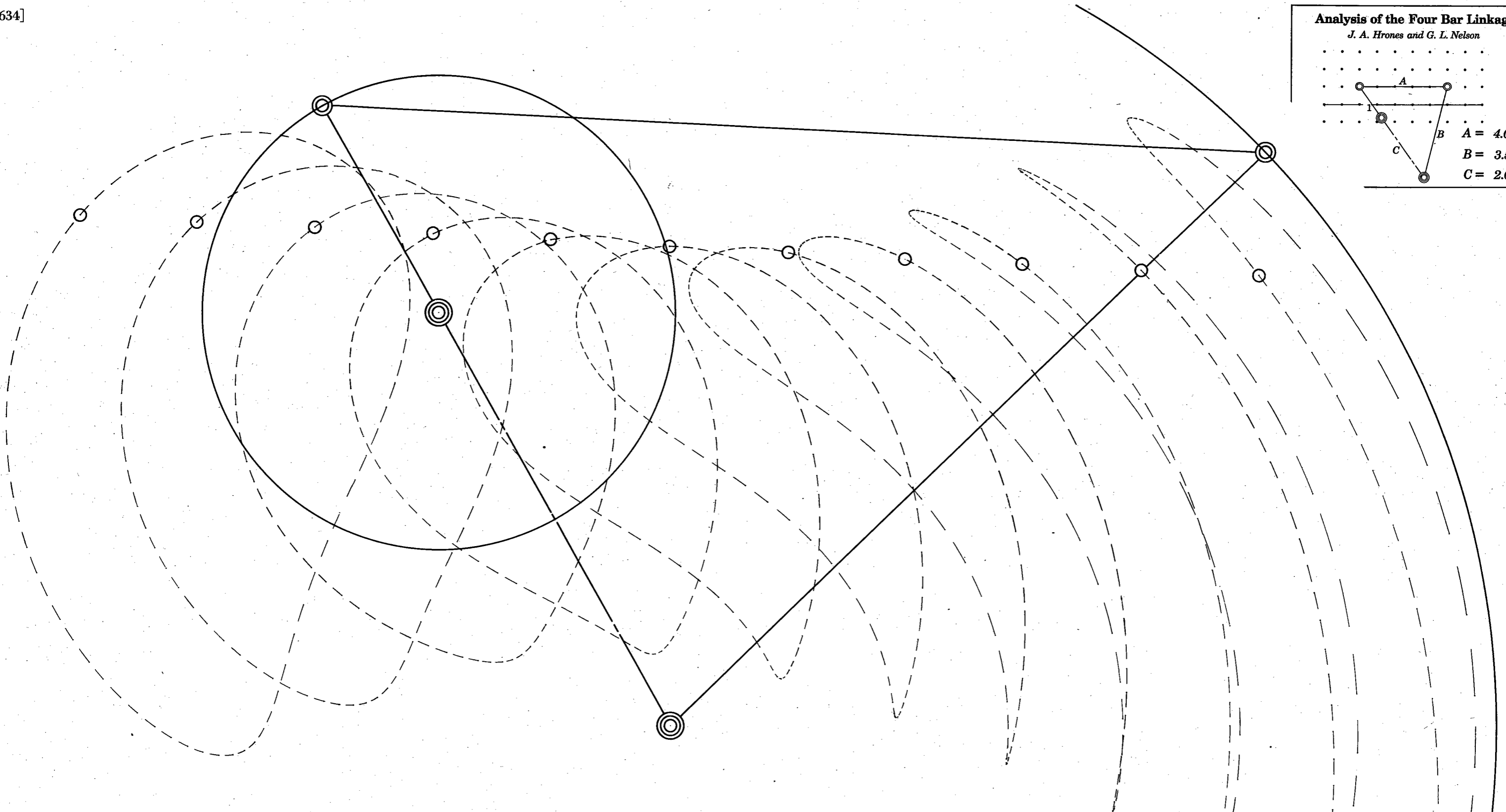

from  
Design of Machinery 4ed  
by Robert L. Norton  
McGraw-Hill  
Copyright 2008

**Analysis of the Four Bar Linkage**  
*J. A. Hrones and G. L. Nelson*

A = 4.0  
 B = 3.5  
 C = 2.0

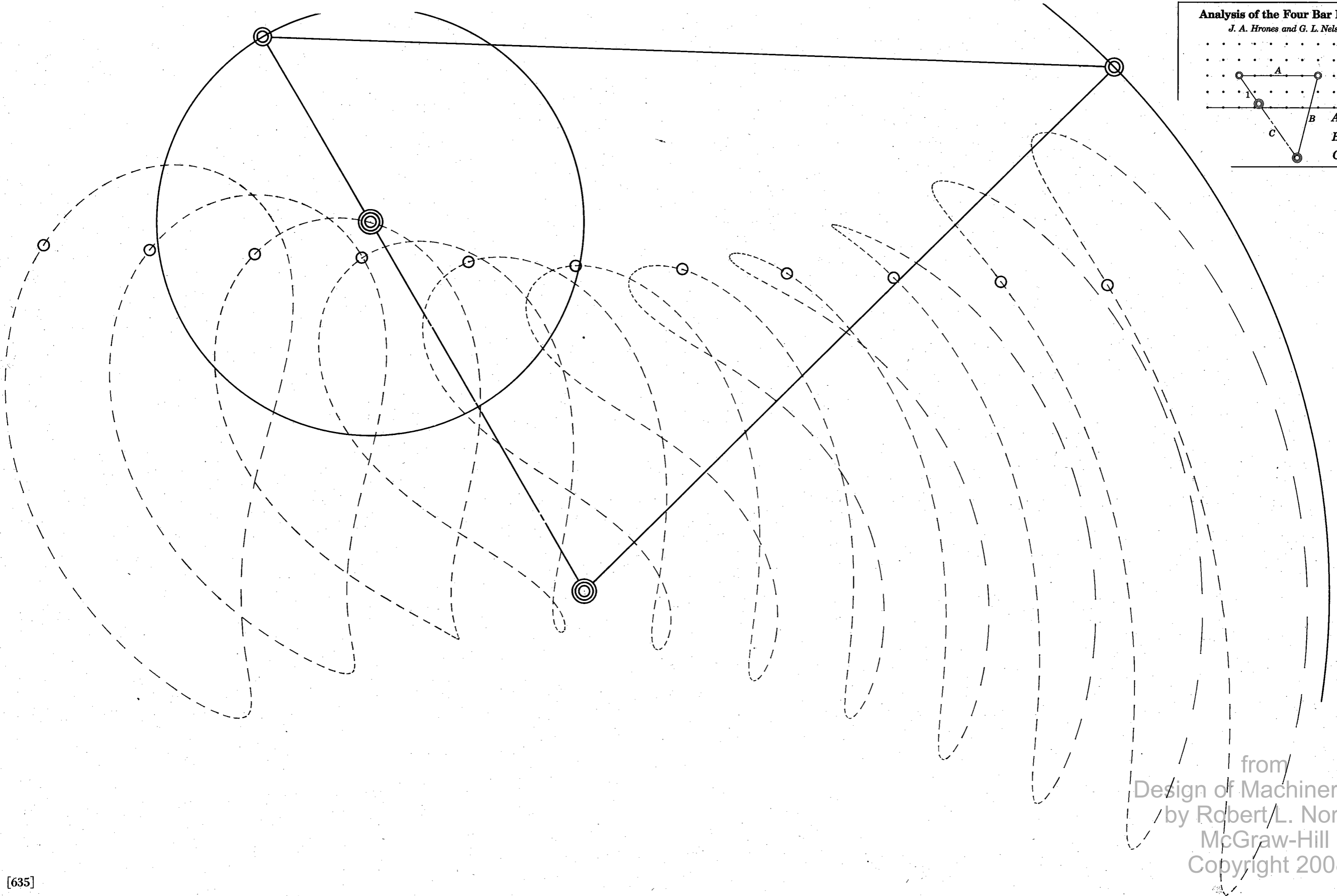

from  
 Design of Machinery 4ed  
 by Robert L. Norton  
 McGraw-Hill  
 Copyright 2008



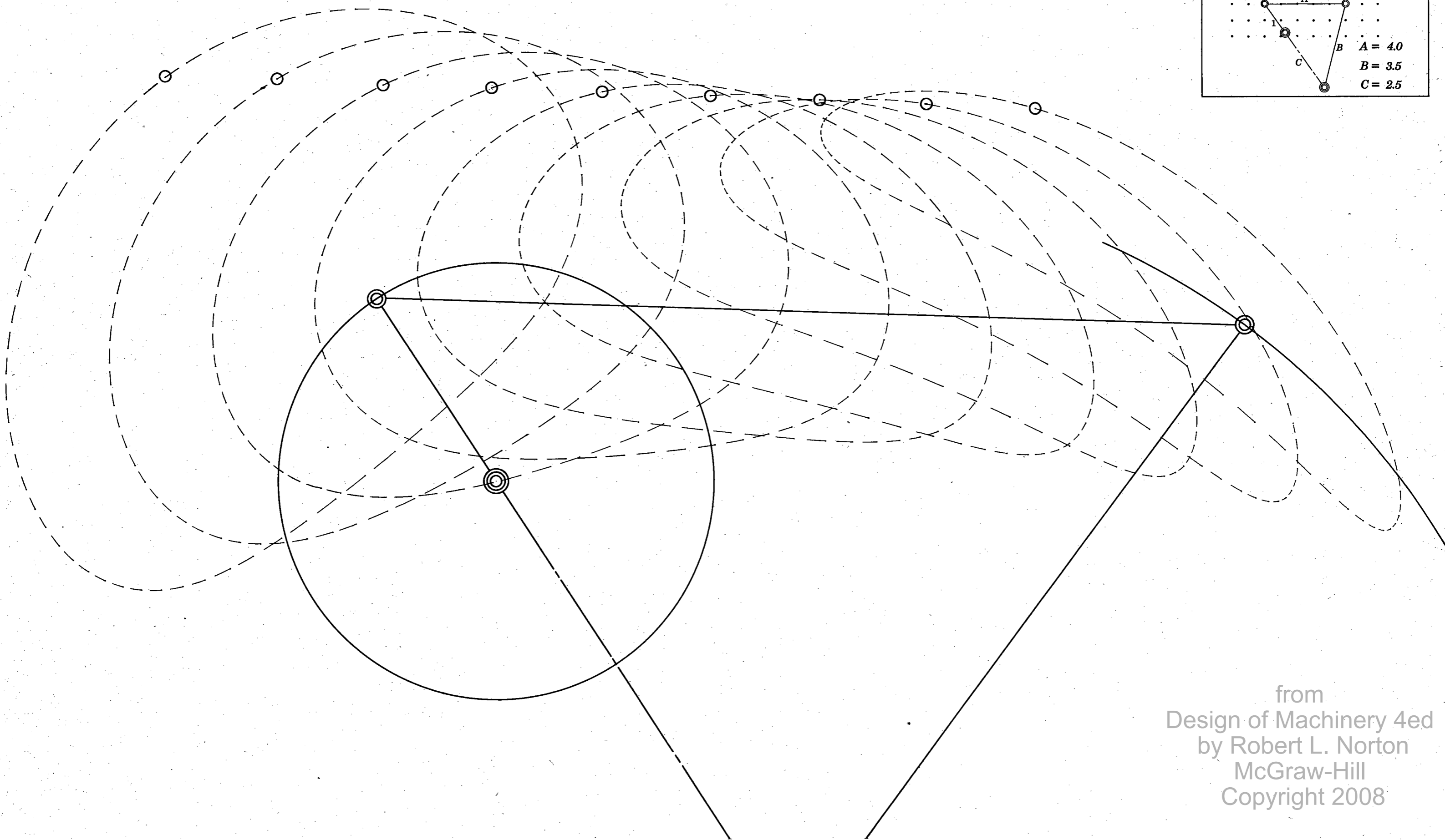
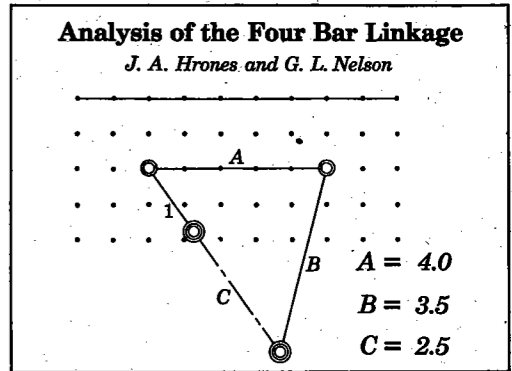

from  
Design of Machinery 4ed  
by Robert L. Norton  
McGraw-Hill  
Copyright 2008

**Analysis of the Four Bar Linkage**  
*J. A. Hrones and G. L. Nelson*

$A = 4.0$   
 $B = 3.5$   
 $C = 2.5$

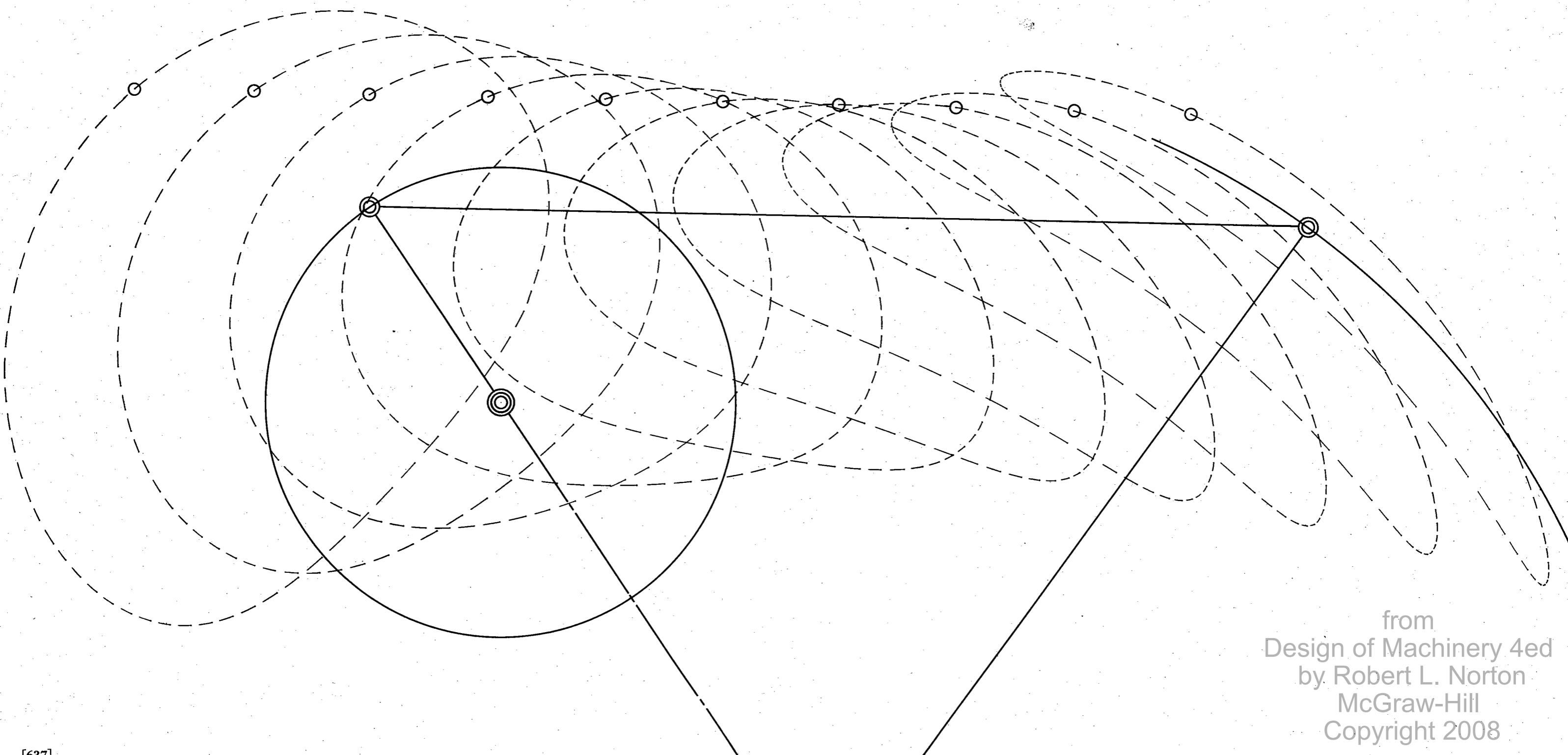

from  
 Design of Machinery 4ed  
 by Robert L. Norton  
 McGraw-Hill  
 Copyright 2008

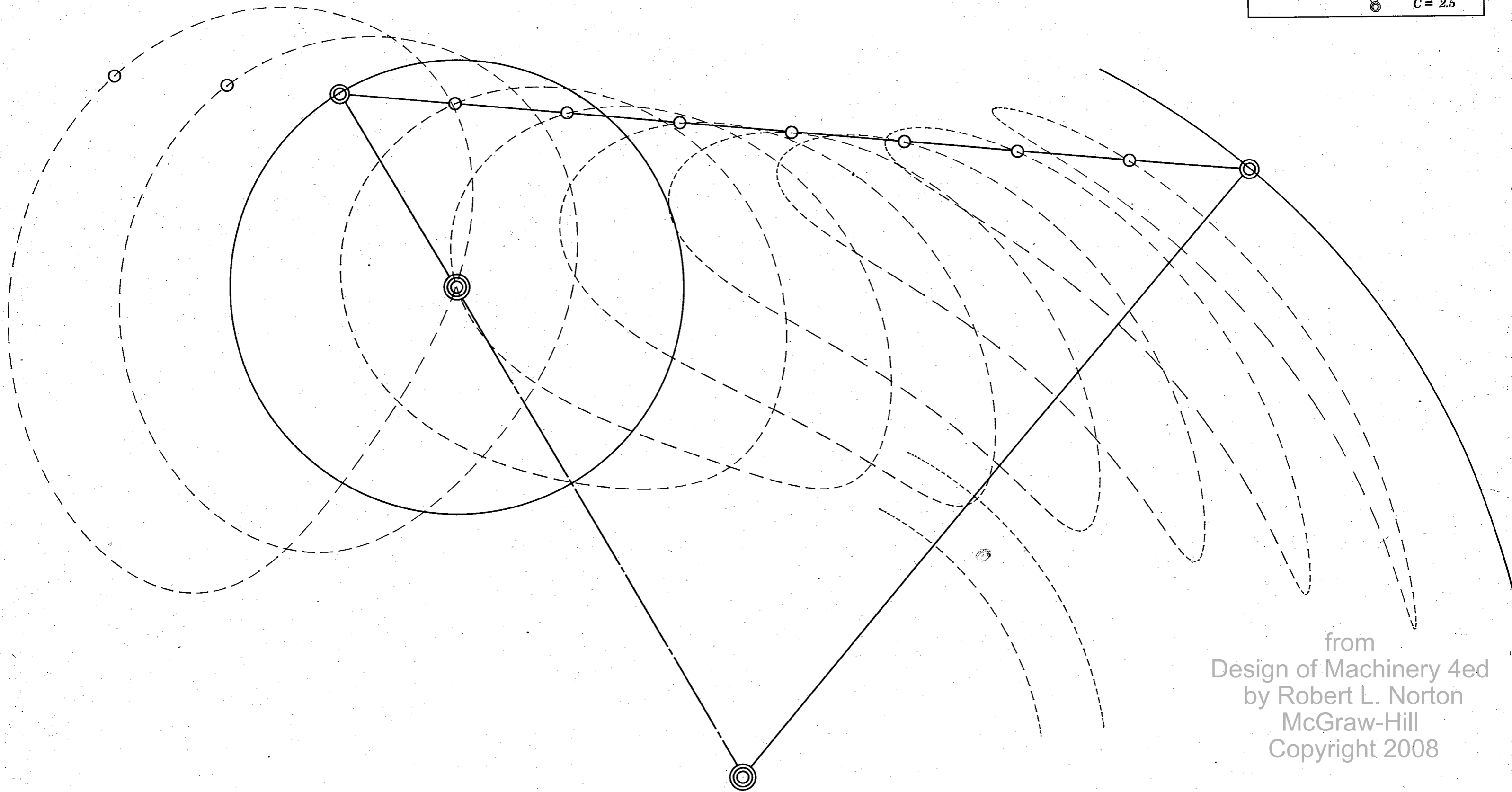
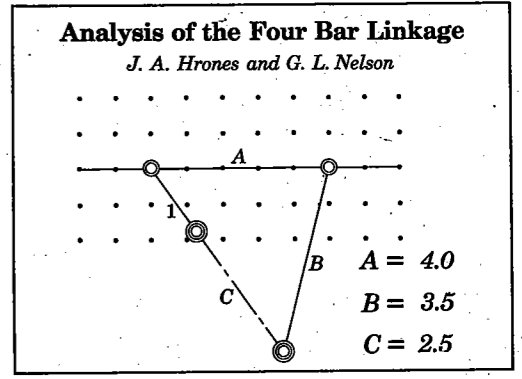

from  
Design of Machinery 4ed  
by Robert L. Norton  
McGraw-Hill  
Copyright 2008

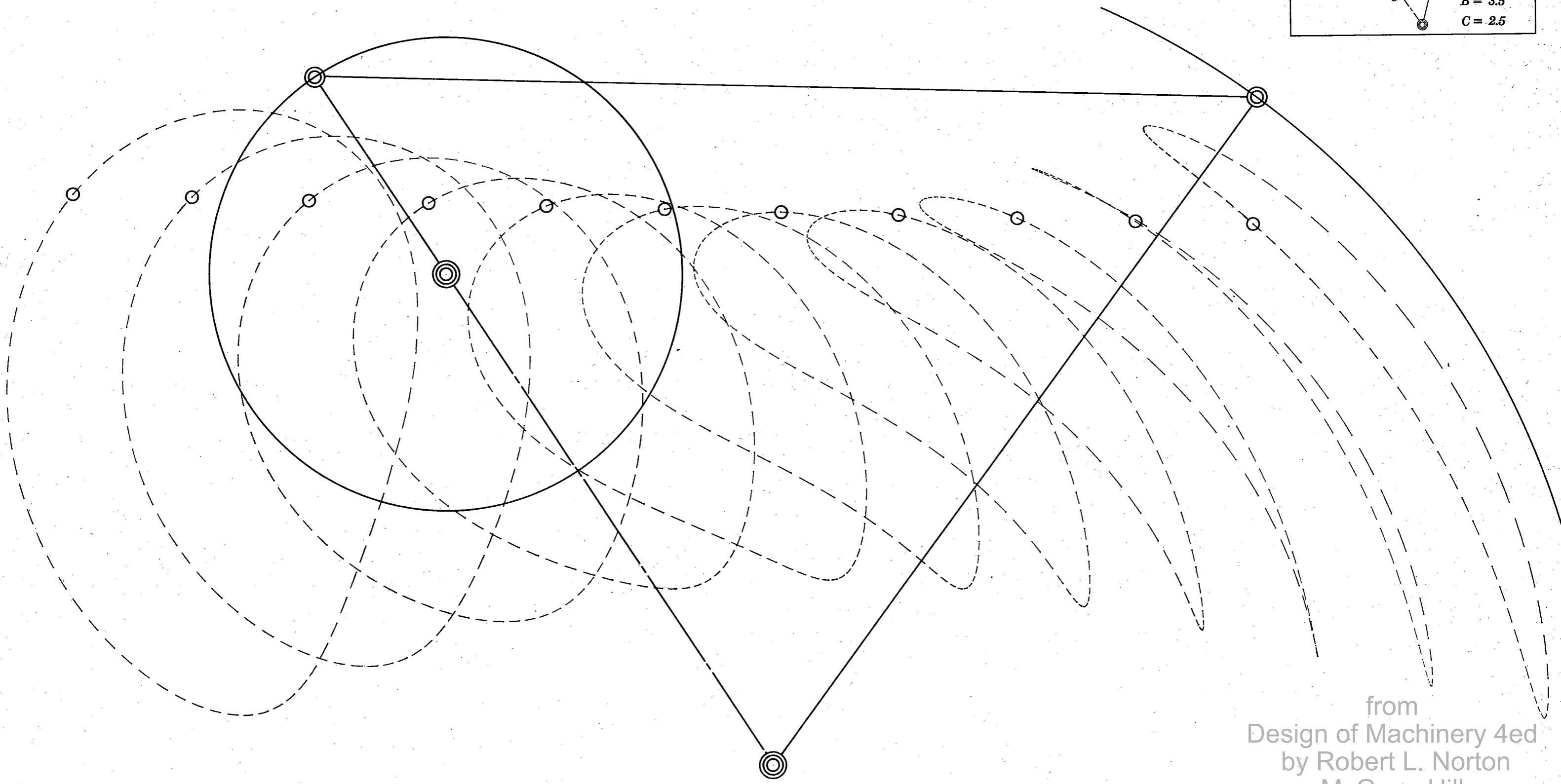
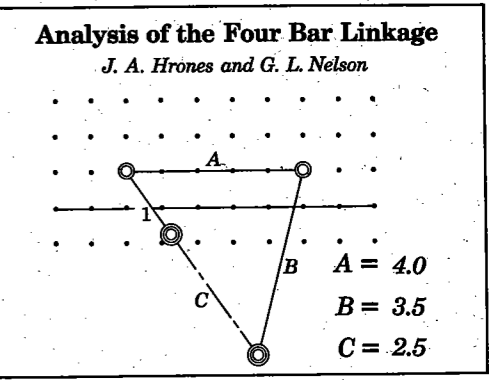

from  
 Design of Machinery 4ed  
 by Robert L. Norton  
 McGraw-Hill  
 Copyright 2008

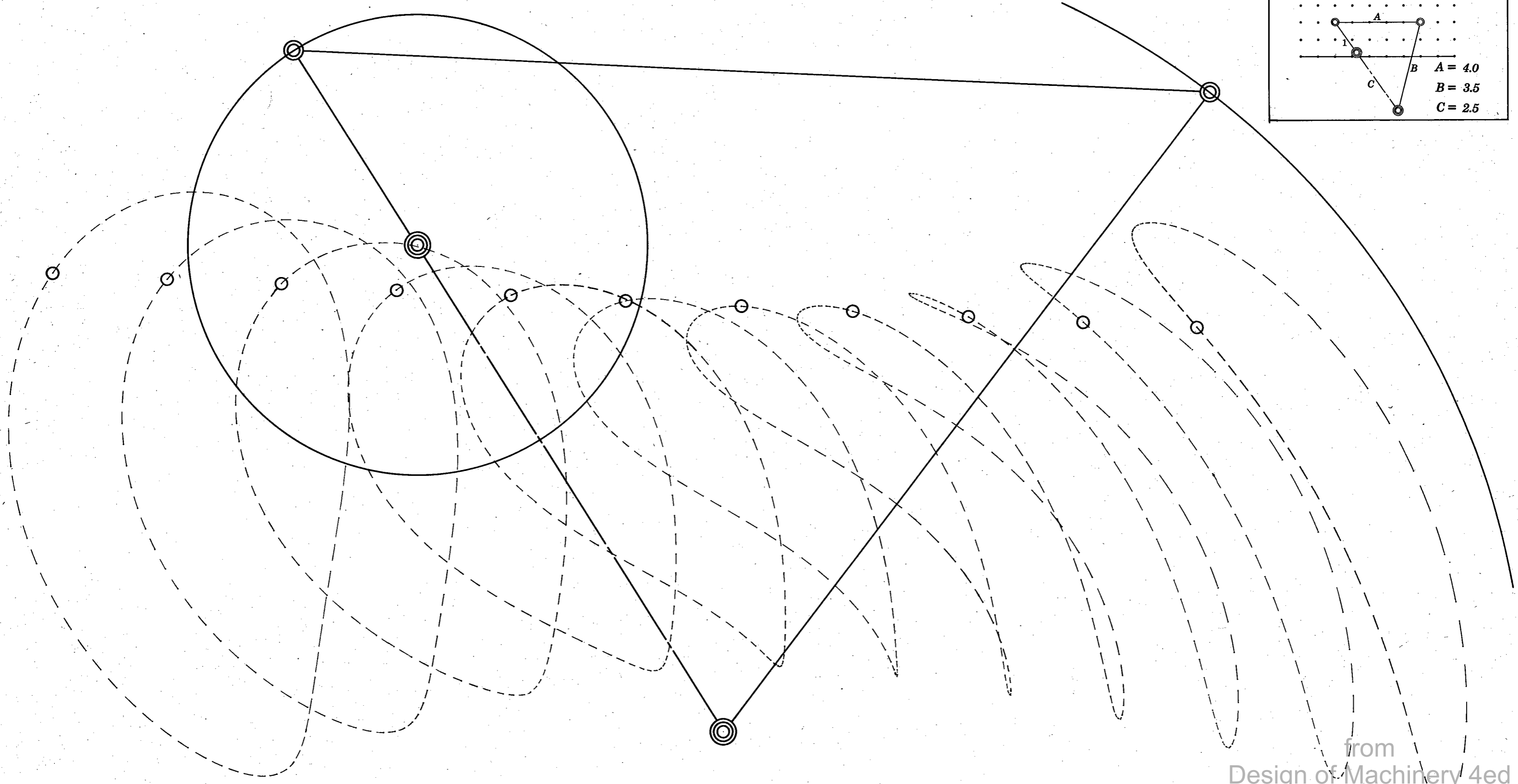
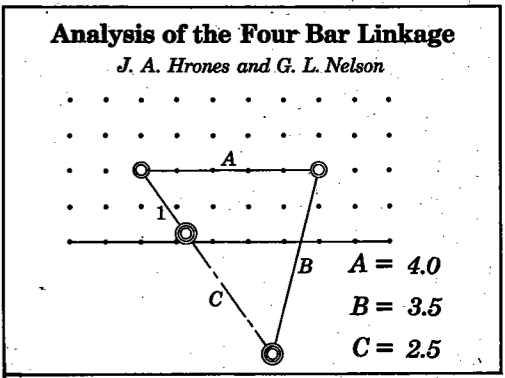

from  
Design of Machinery 4ed  
by Robert L. Norton  
McGraw-Hill  
Copyright 2008

Analysis of the Four Bar Linkage

J. A. Hrones and G. L. Nelson

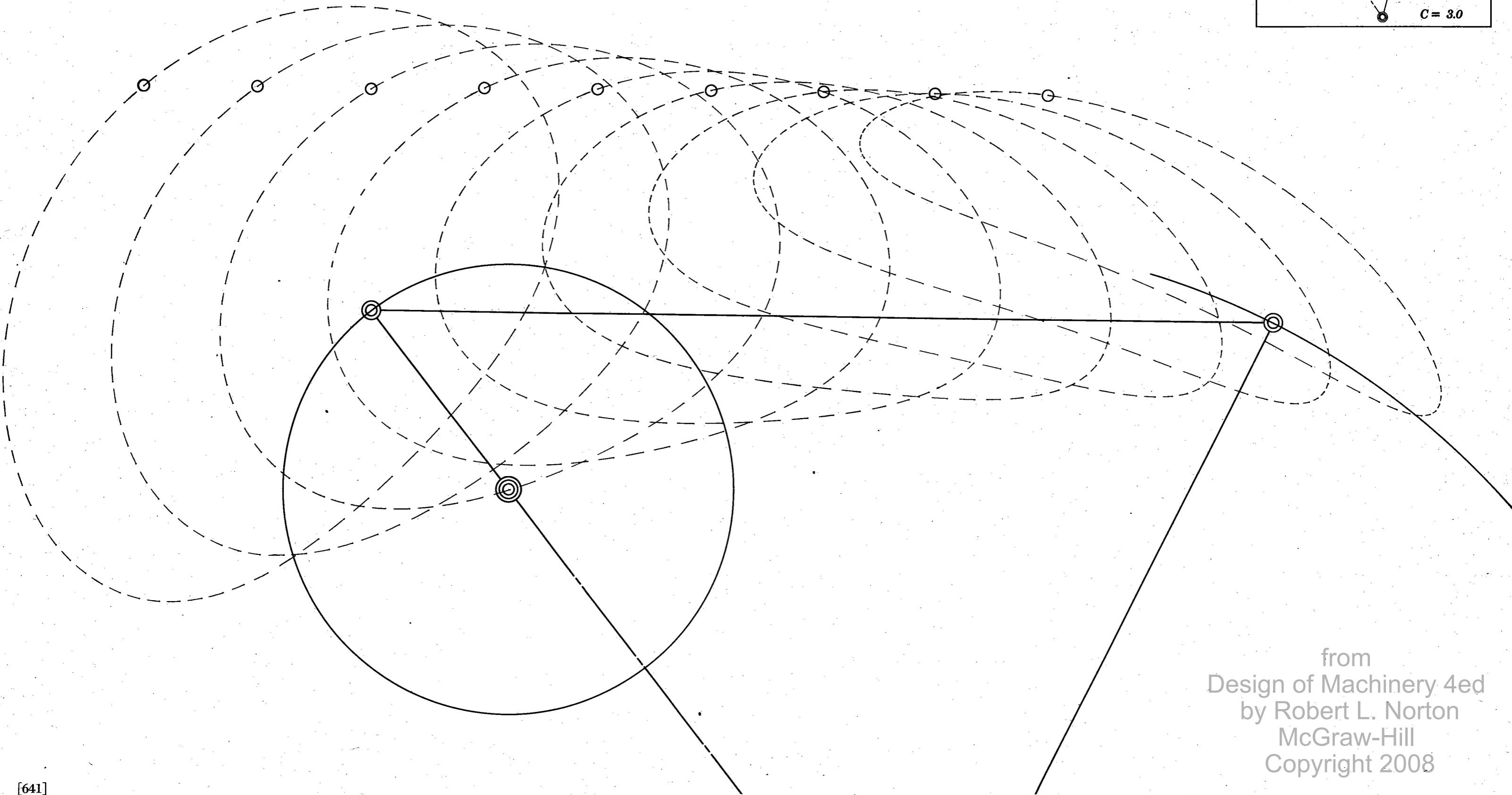
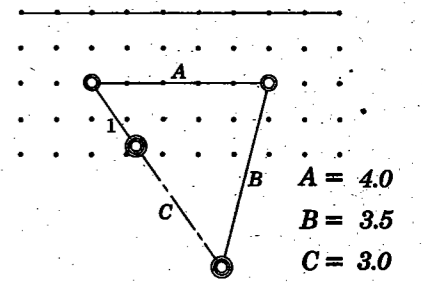

from  
Design of Machinery 4ed  
by Robert L. Norton  
McGraw-Hill  
Copyright 2008

**Analysis of the Four Bar Linkage**

*J. A. Hrones and G. L. Nelson*

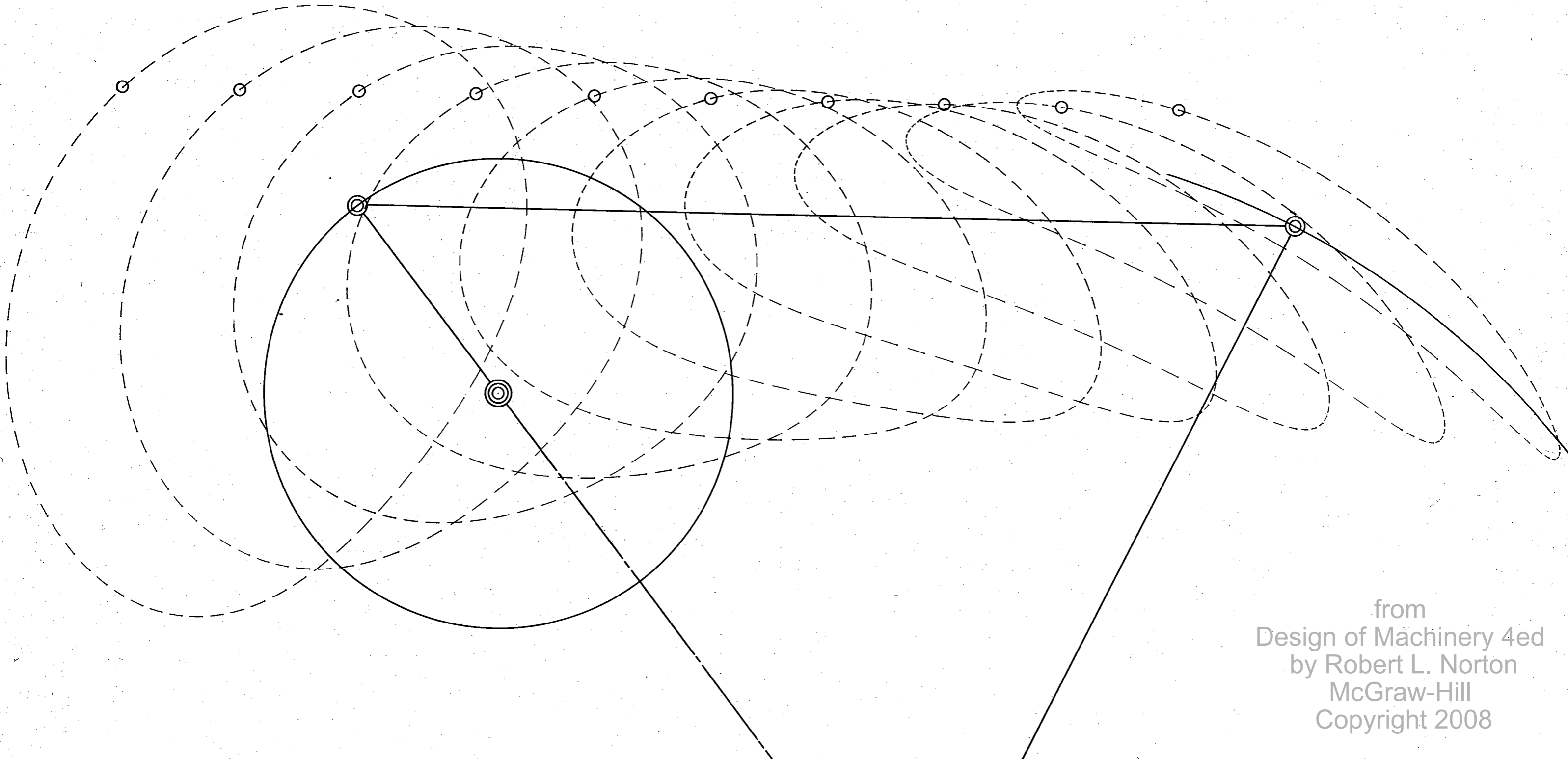
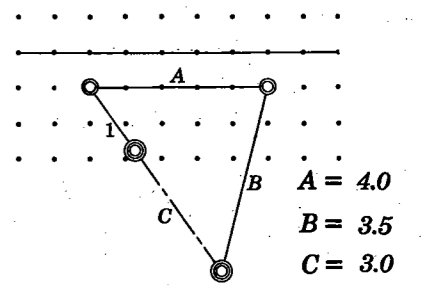

from  
Design of Machinery 4ed  
by Robert L. Norton  
McGraw-Hill  
Copyright 2008

**Analysis of the Four Bar Linkage**

*J. A. Hrones and G. L. Nelson*

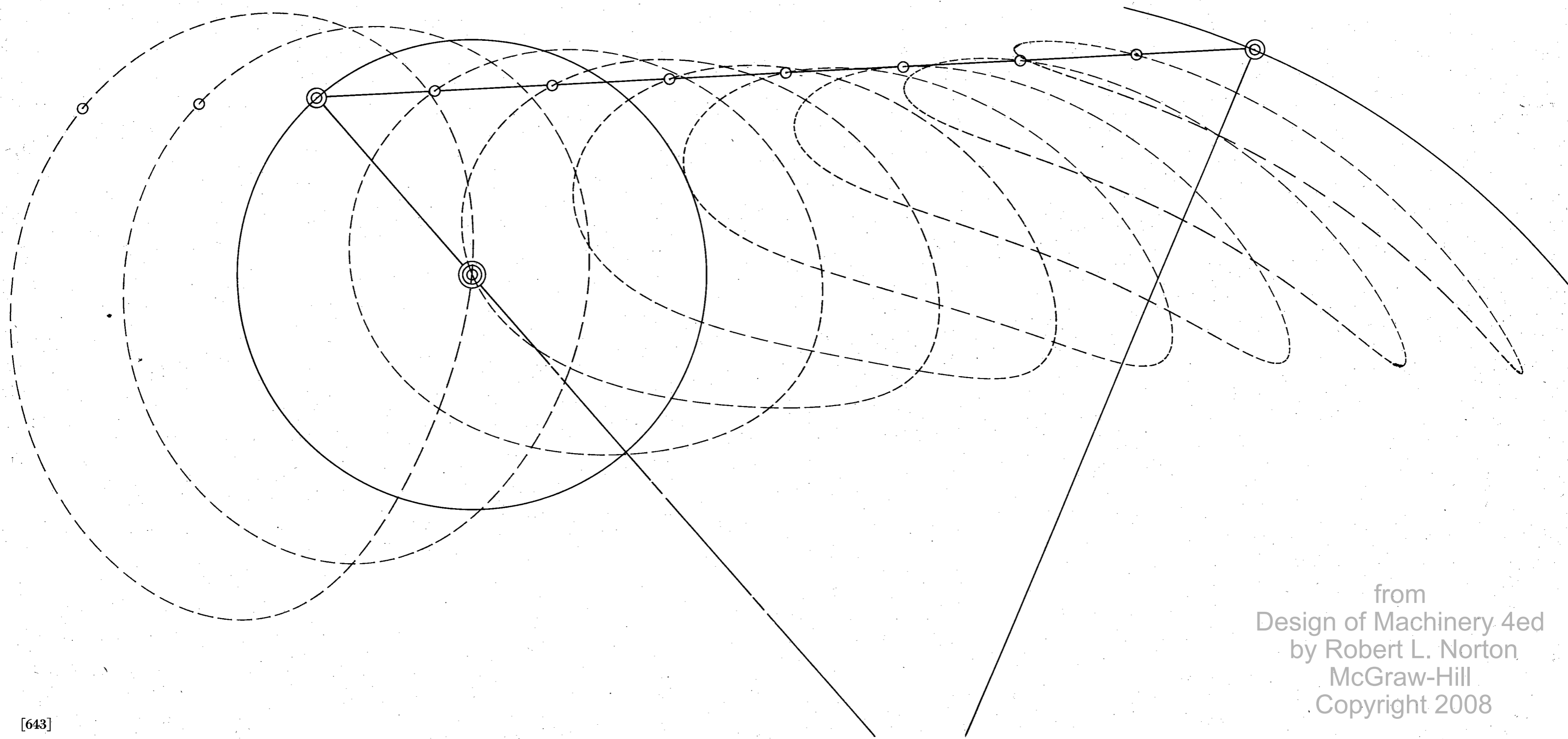
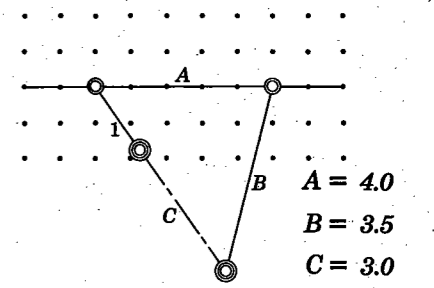

from  
Design of Machinery 4ed  
by Robert L. Norton  
McGraw-Hill  
Copyright 2008



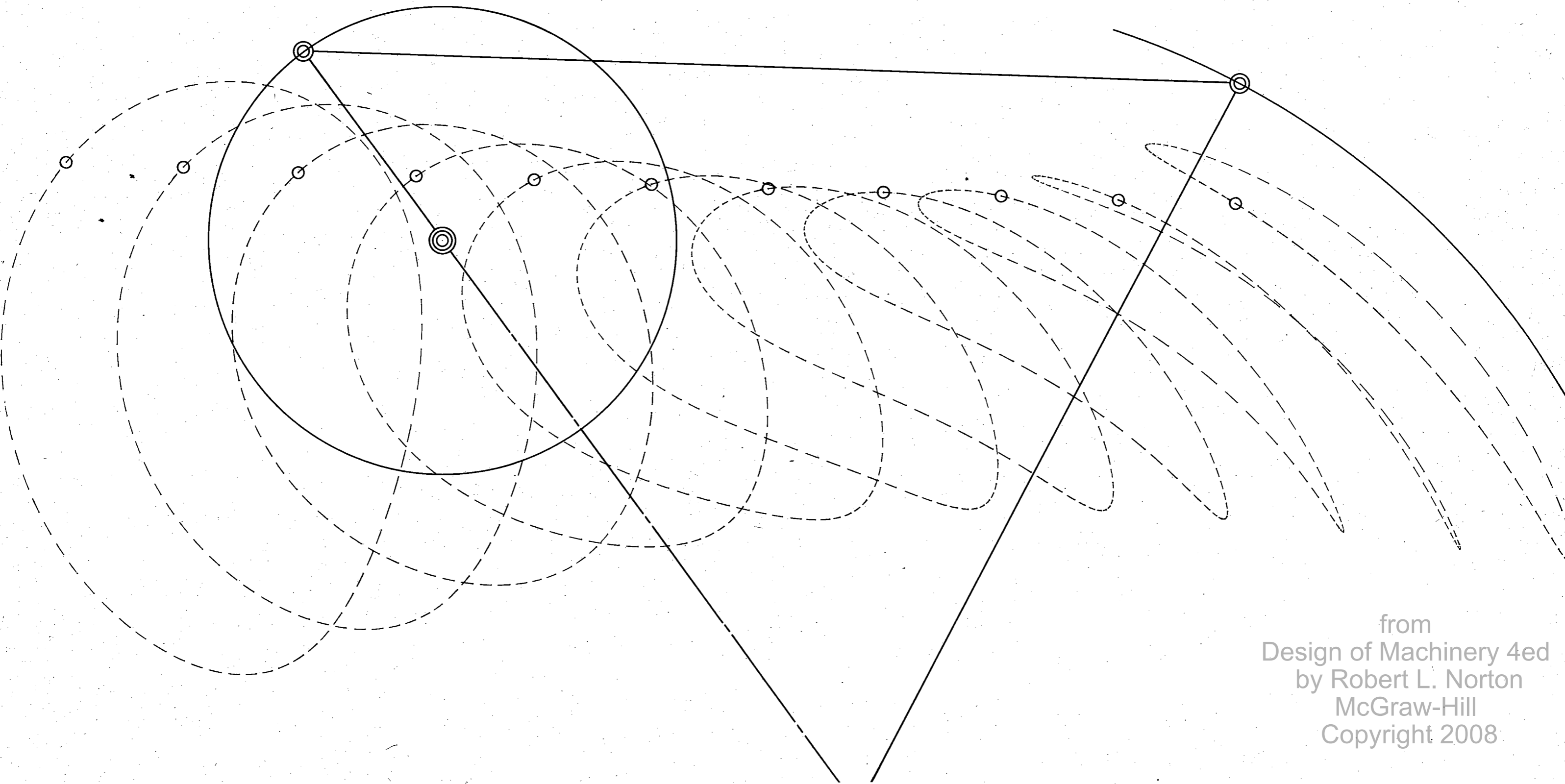
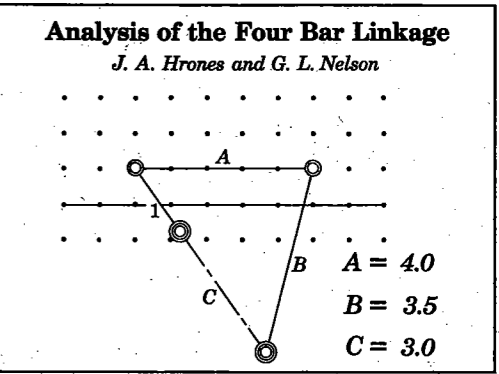

from  
Design of Machinery 4ed  
by Robert L. Norton  
McGraw-Hill  
Copyright 2008

**Analysis of the Four Bar Linkage**

*J. A. Hrones and G. L. Nelson*

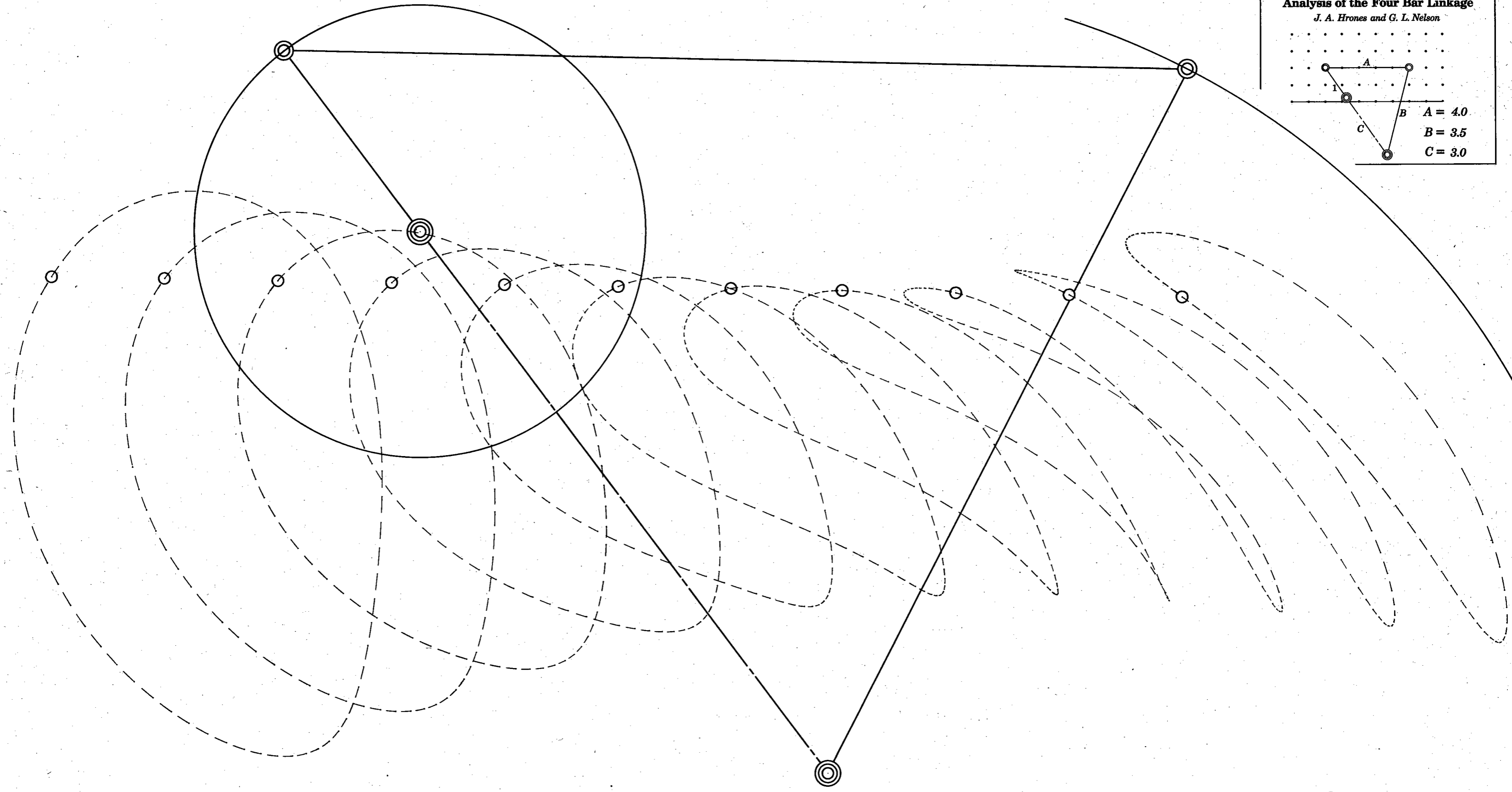
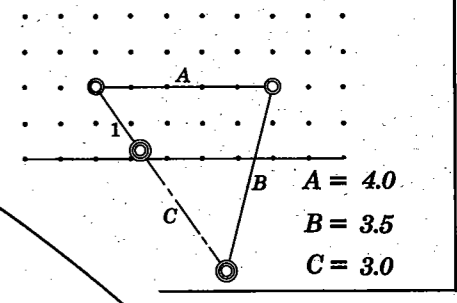

from  
Design of Machinery 4ed  
by Robert L. Norton  
McGraw-Hill  
Copyright 2008

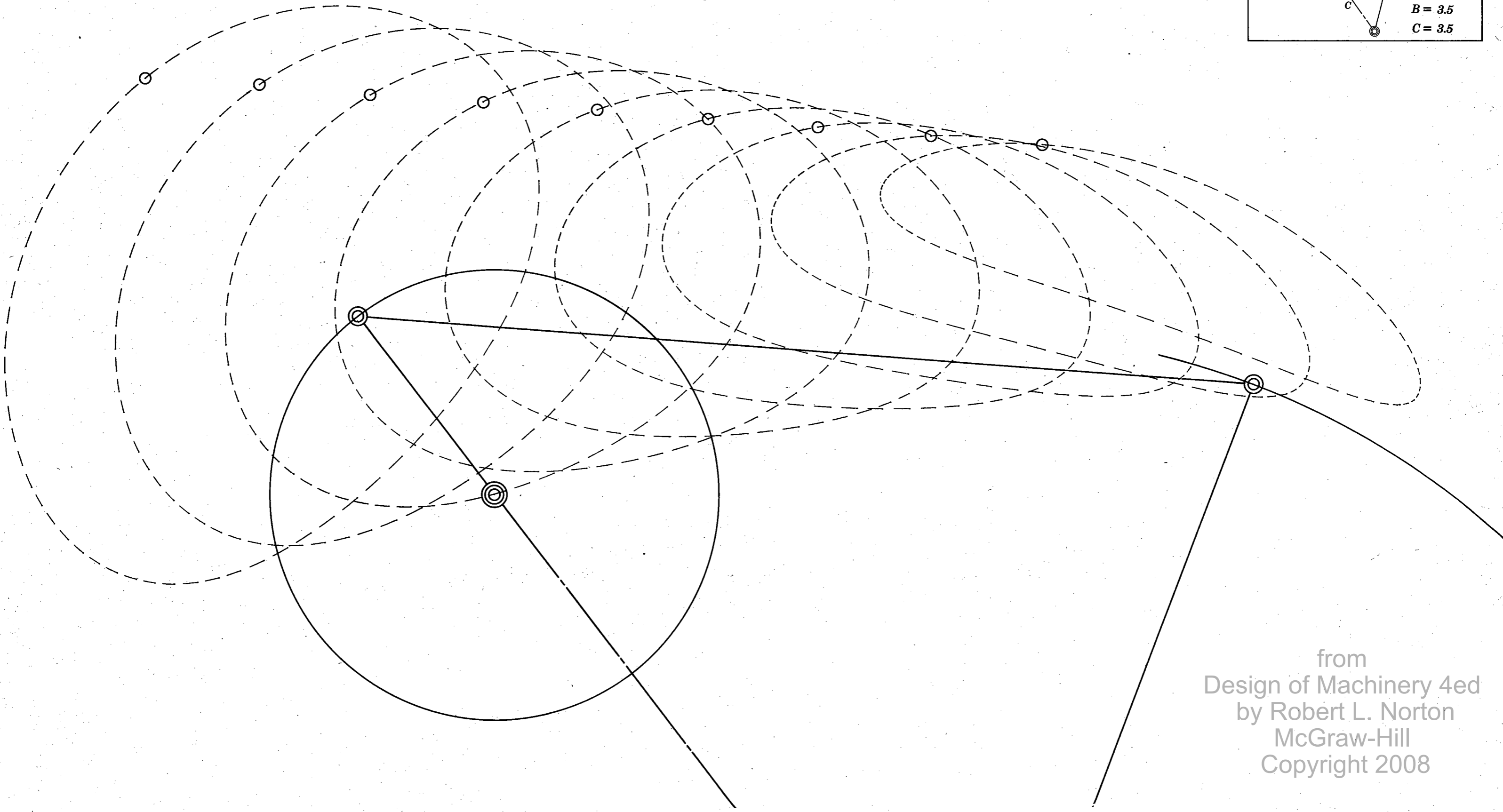
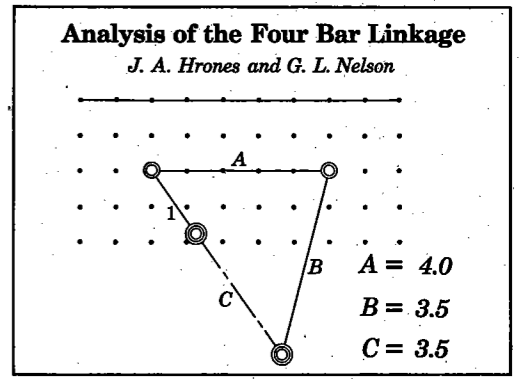

from  
Design of Machinery 4ed  
by Robert L. Norton  
McGraw-Hill  
Copyright 2008

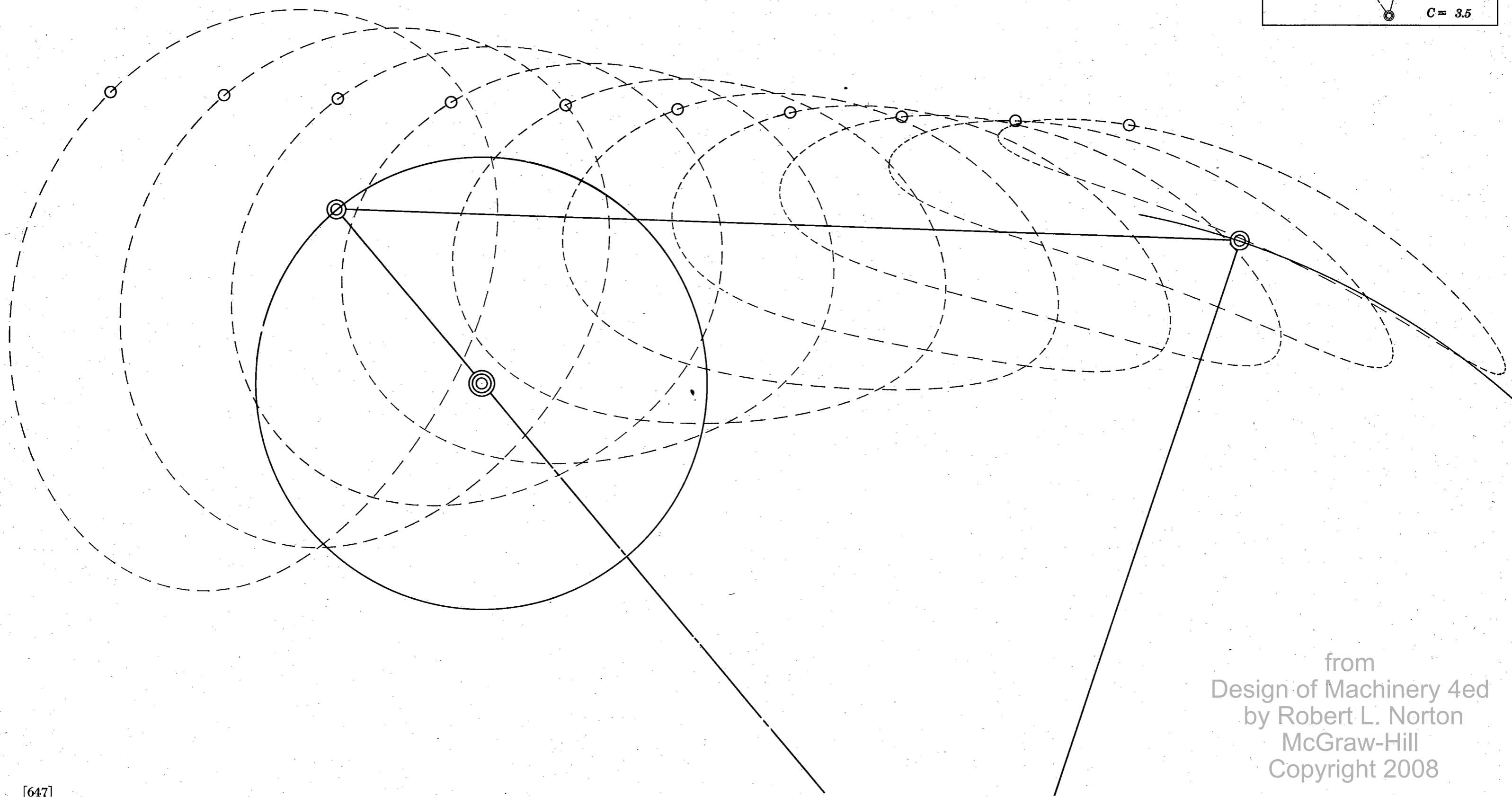
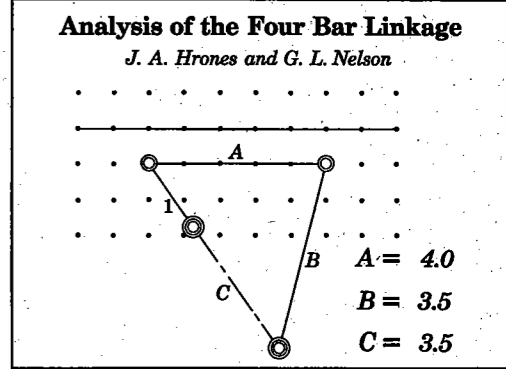

from  
 Design of Machinery 4ed  
 by Robert L. Norton  
 McGraw-Hill  
 Copyright 2008

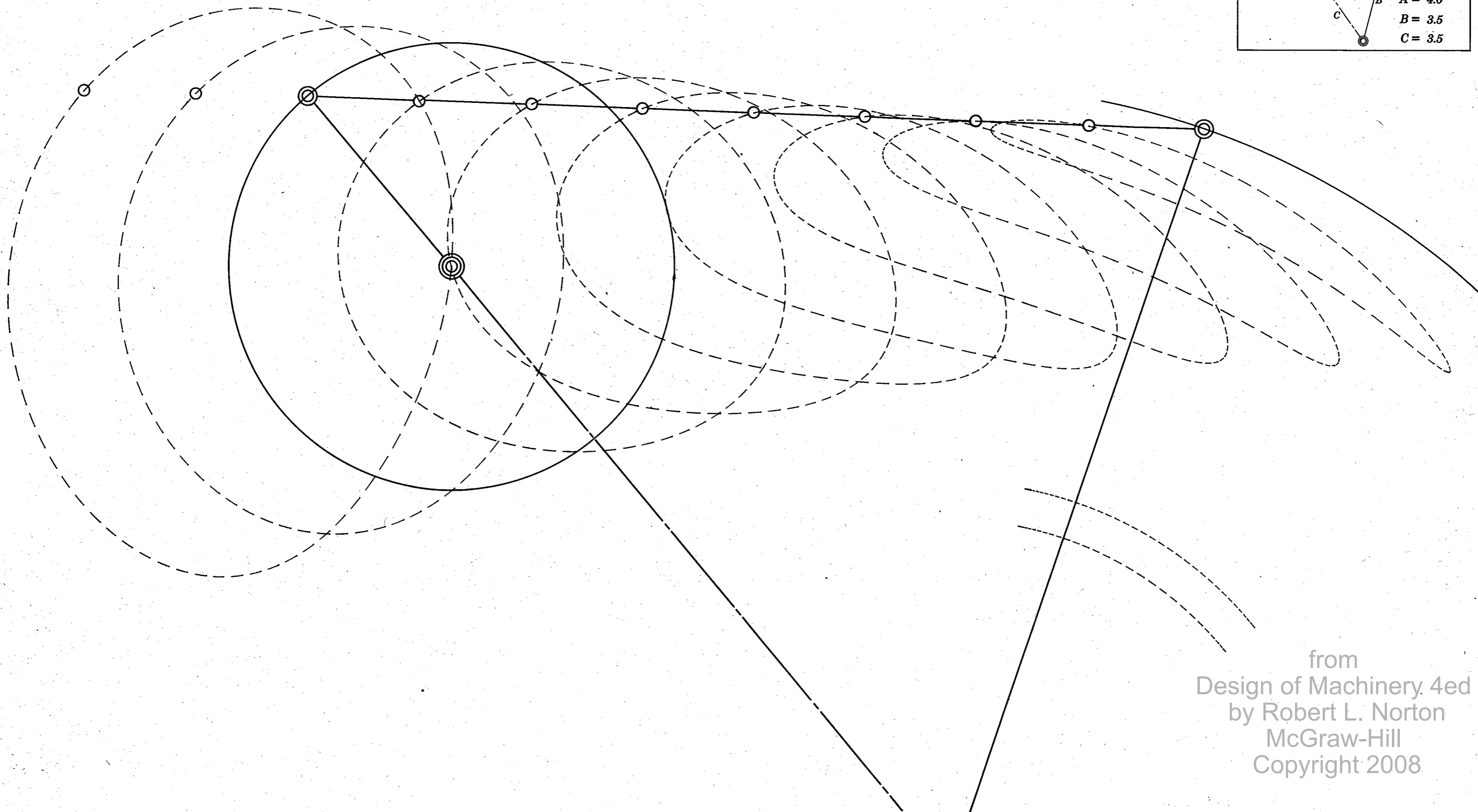
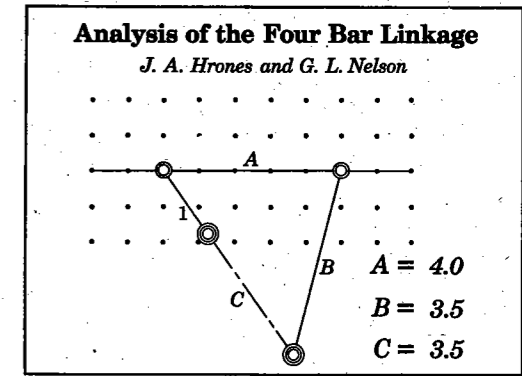

from  
 Design of Machinery, 4ed  
 by Robert L. Norton  
 McGraw-Hill  
 Copyright 2008.

**Analysis of the Four Bar Linkage**  
*J. A. Hrones and G. L. Nelson*

$A = 4.0$   
 $B = 3.5$   
 $C = 3.5$

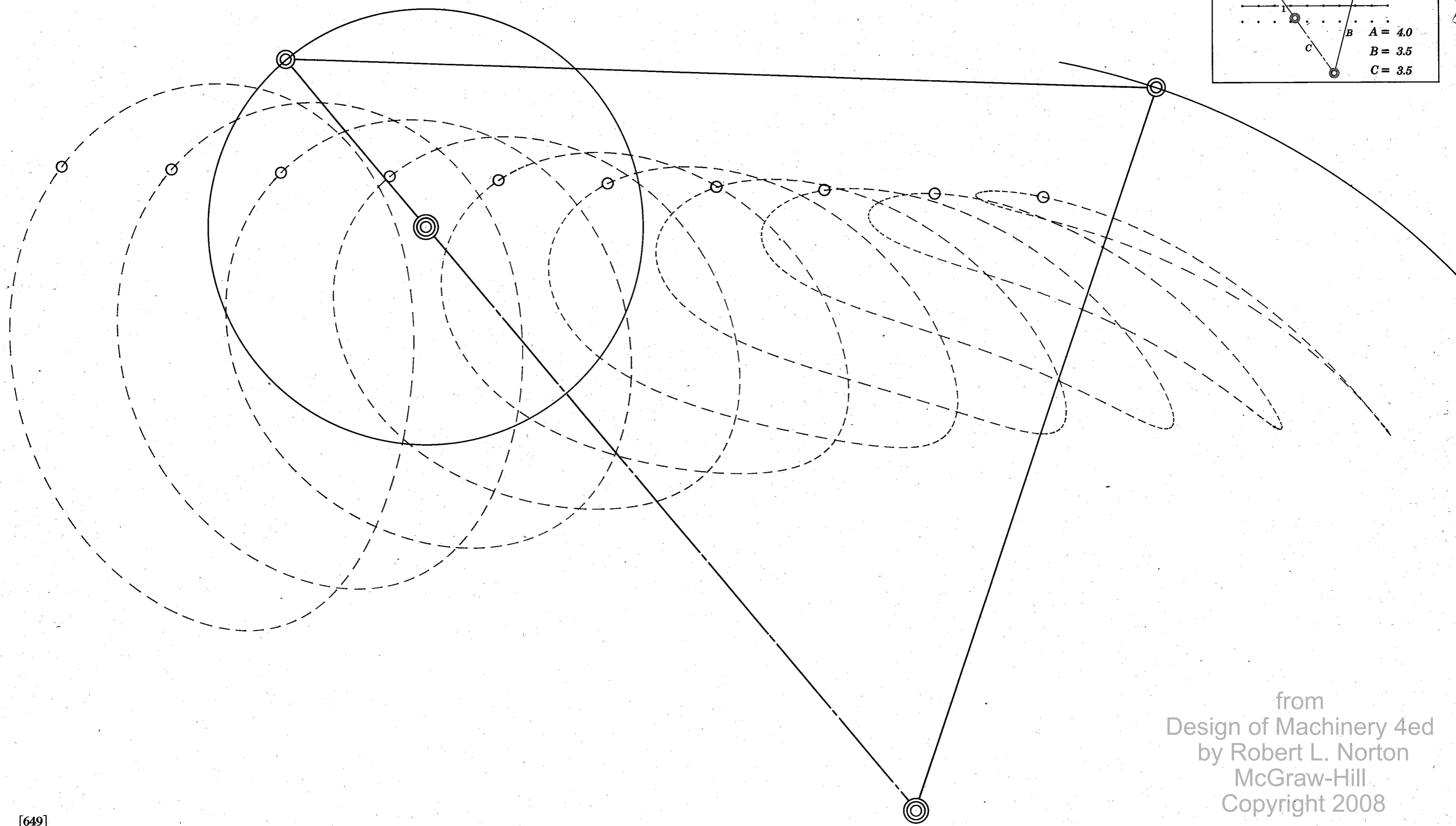

from  
 Design of Machinery 4ed  
 by Robert L. Norton  
 McGraw-Hill  
 Copyright 2008

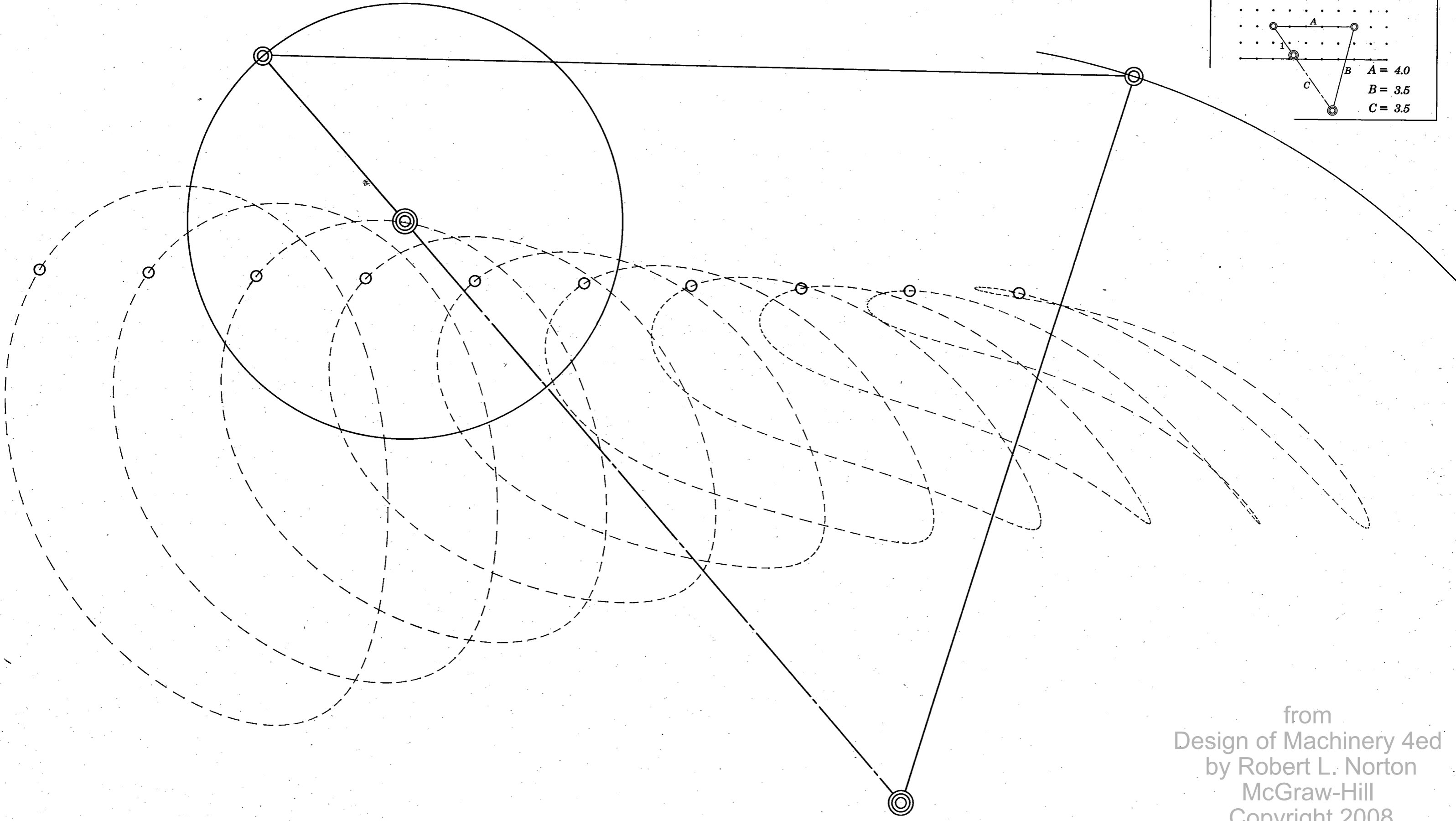
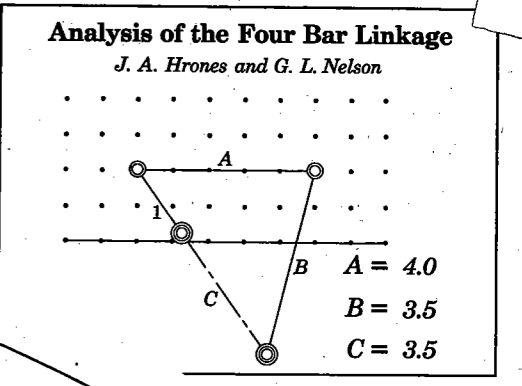

from  
Design of Machinery 4ed  
by Robert L. Norton  
McGraw-Hill  
Copyright 2008

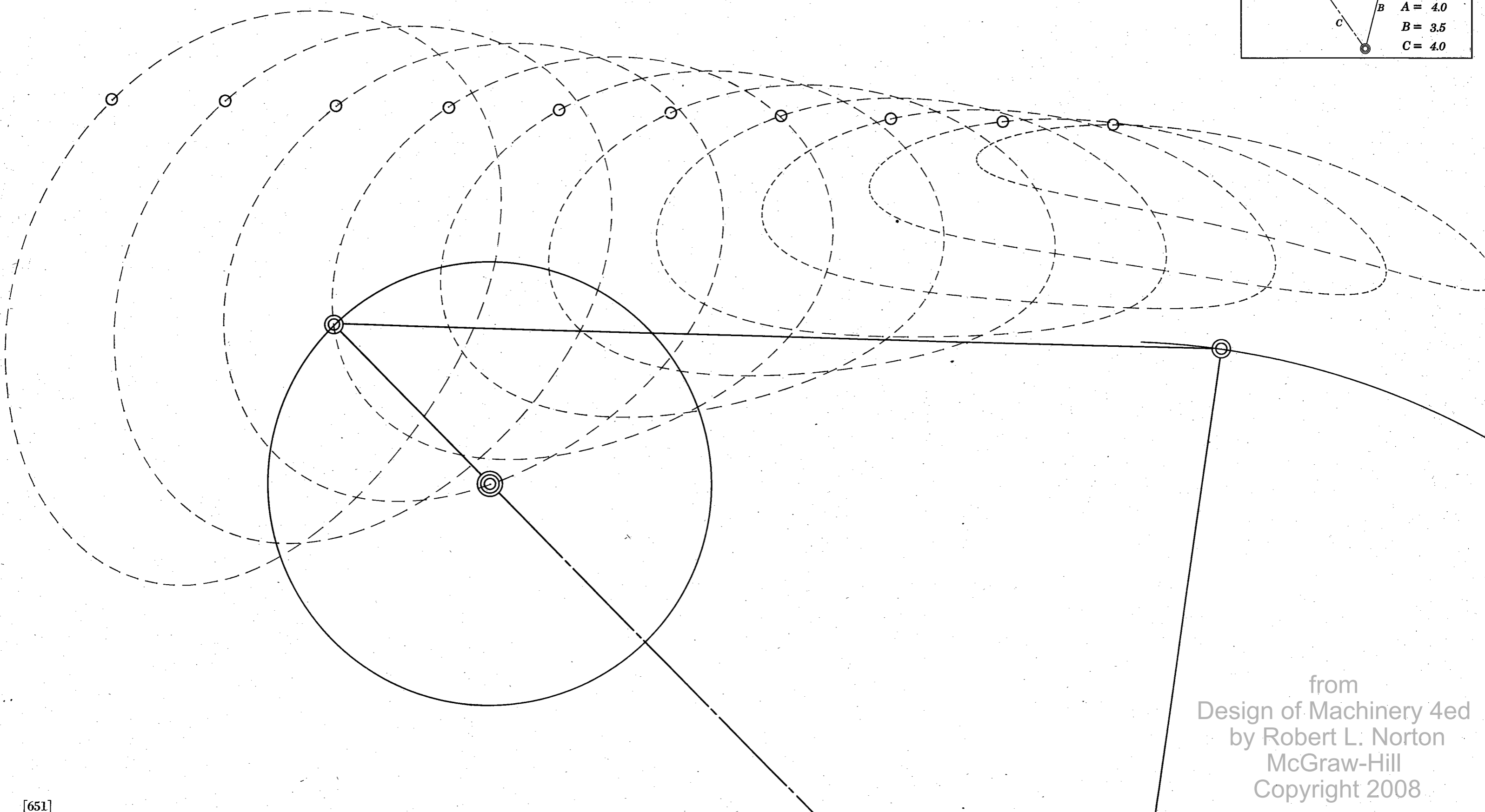
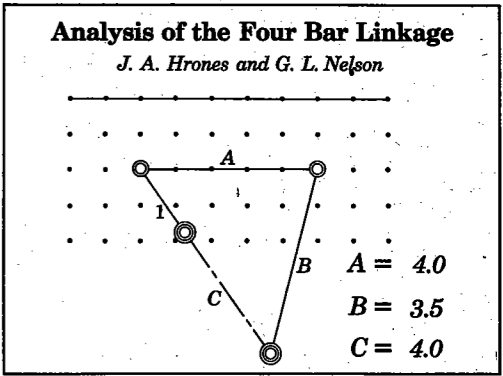

from  
 Design of Machinery 4ed  
 by Robert L. Norton  
 McGraw-Hill  
 Copyright 2008



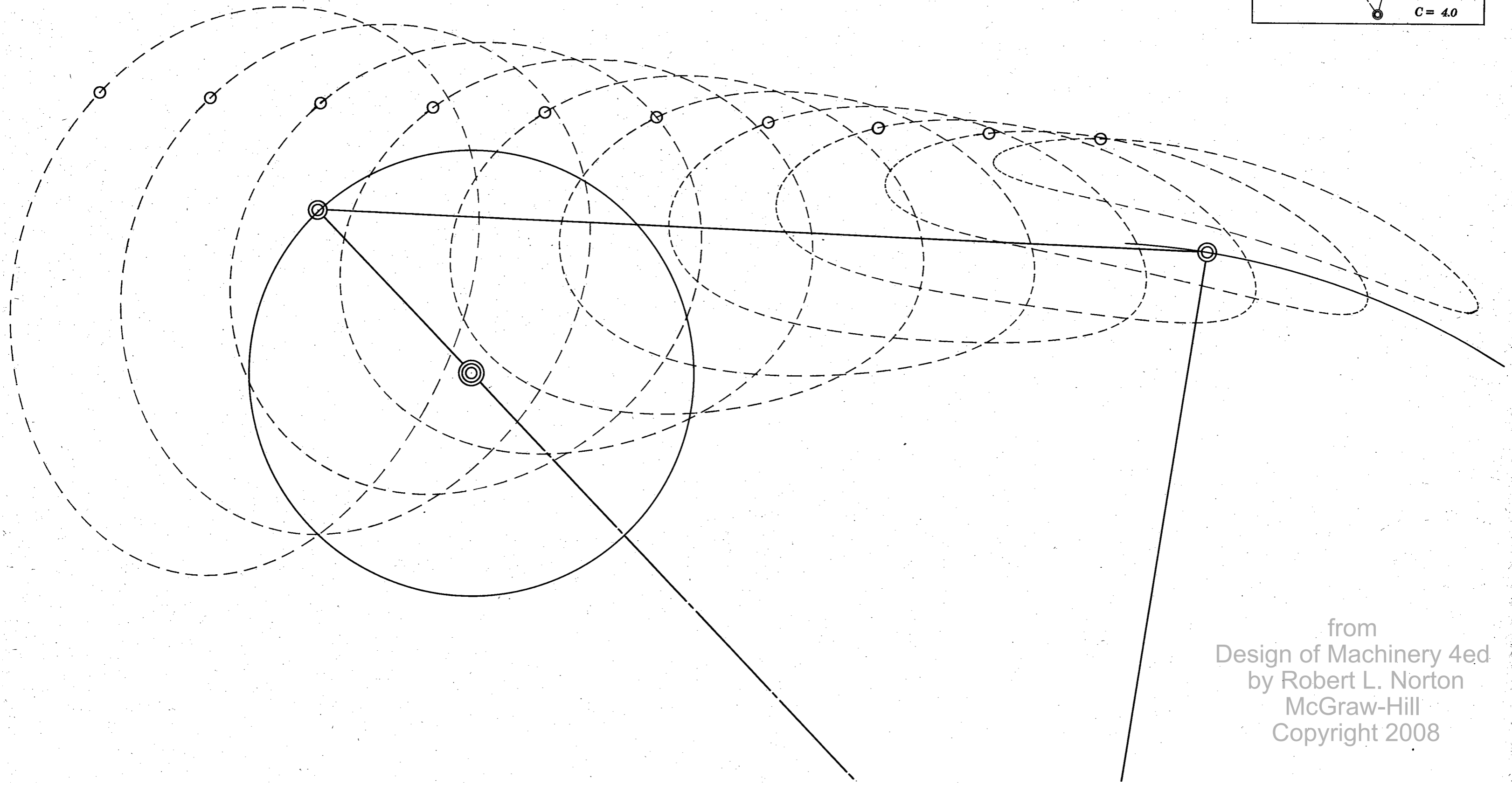
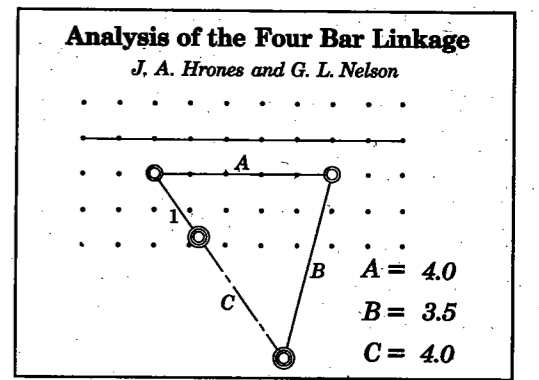

from  
Design of Machinery 4ed  
by Robert L. Norton  
McGraw-Hill  
Copyright 2008

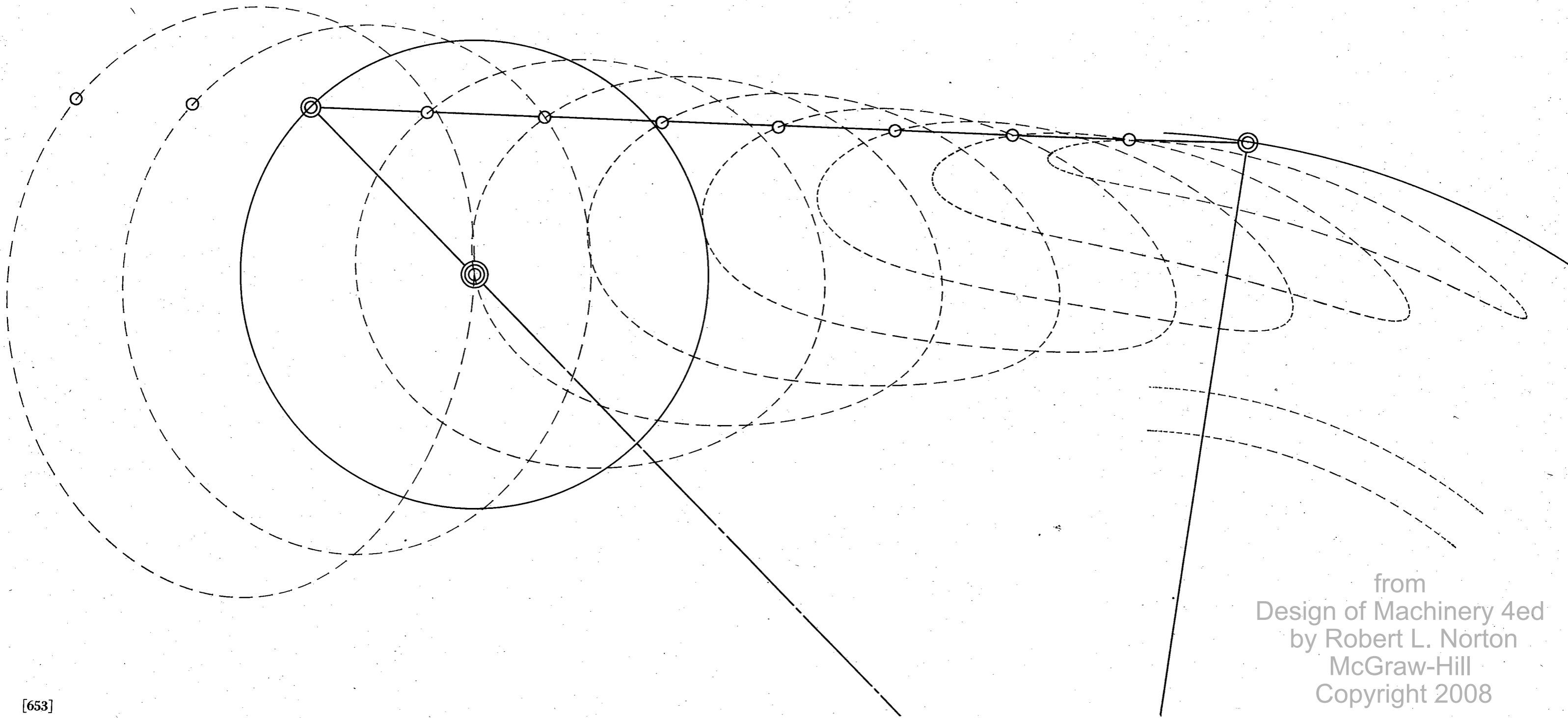
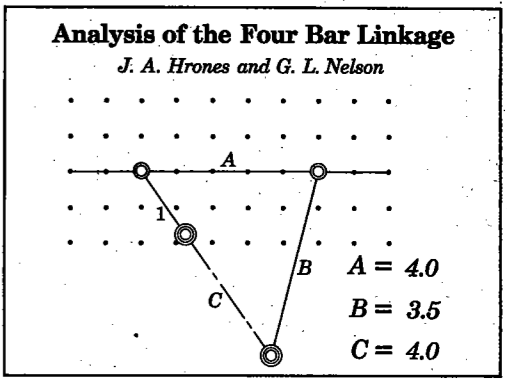

from  
 Design of Machinery 4ed  
 by Robert L. Norton  
 McGraw-Hill  
 Copyright 2008

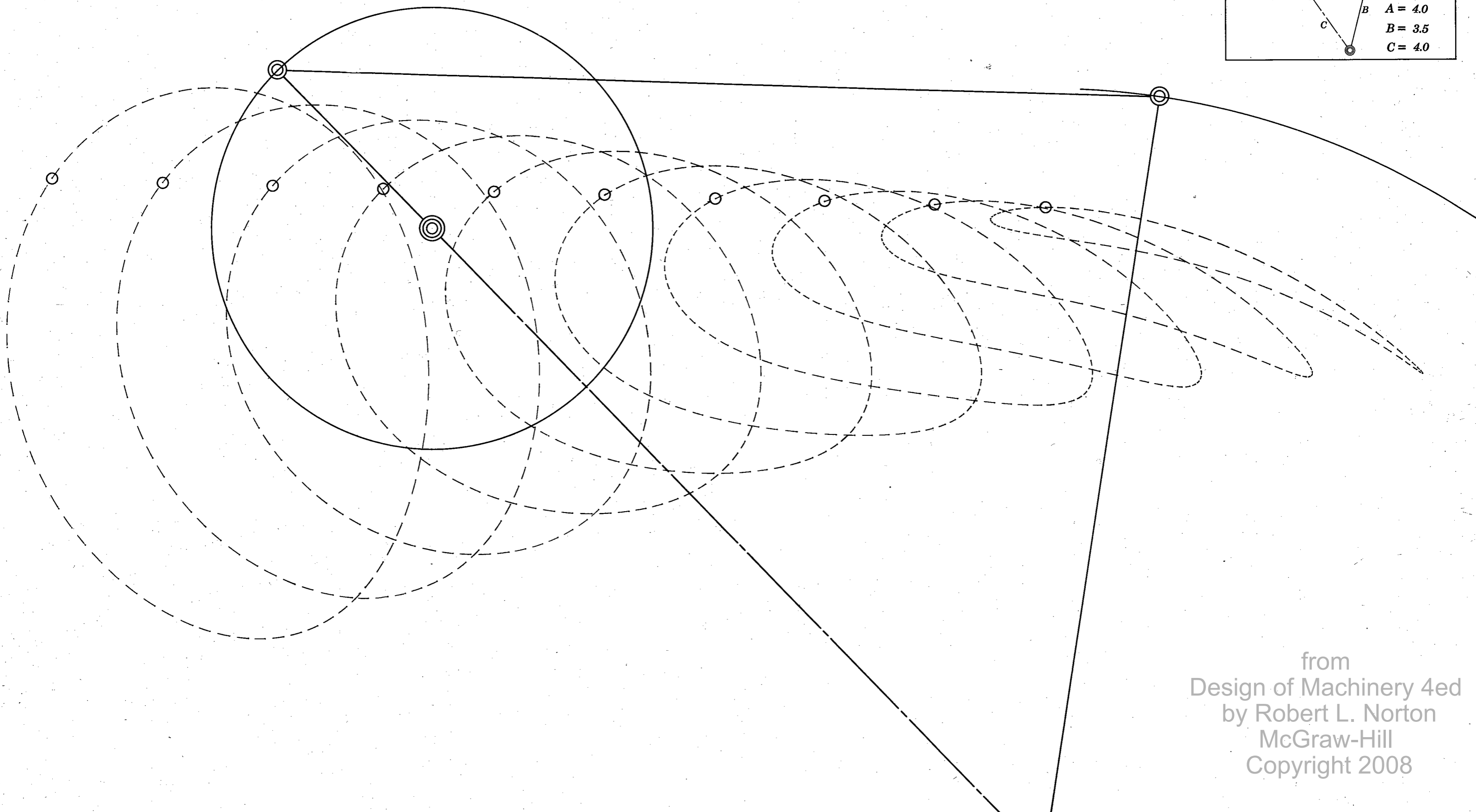
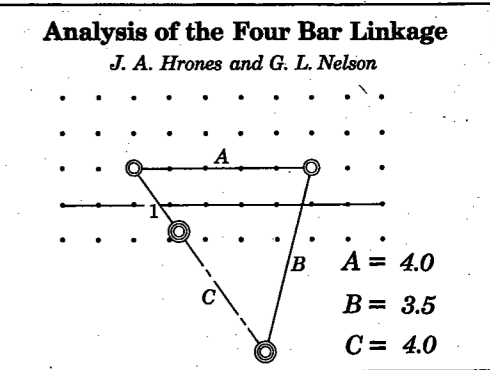

from  
Design of Machinery 4ed  
by Robert L. Norton  
McGraw-Hill  
Copyright 2008

**Analysis of the Four Bar Linkage**

*J. A. Hrones and G. L. Nelson*

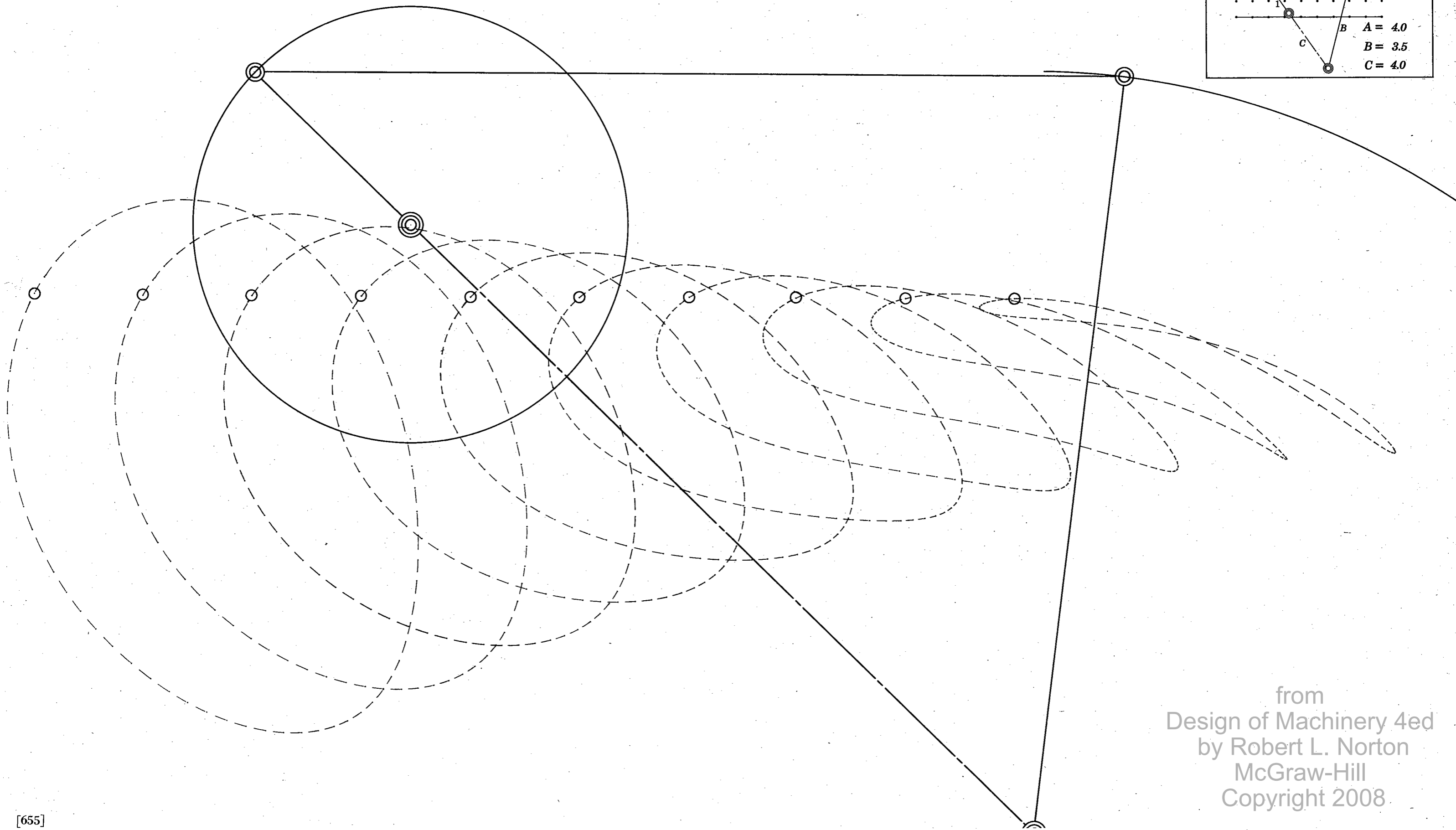
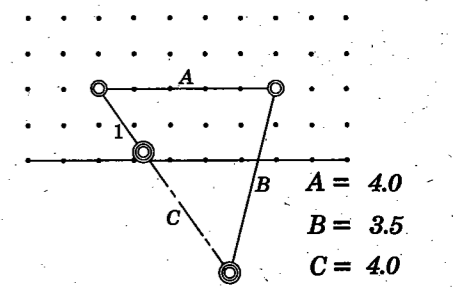

from  
Design of Machinery 4ed  
by Robert L. Norton  
McGraw-Hill  
Copyright 2008

**Analysis of the Four Bar Linkage**  
*J. A. Hrones and G. L. Nelson*

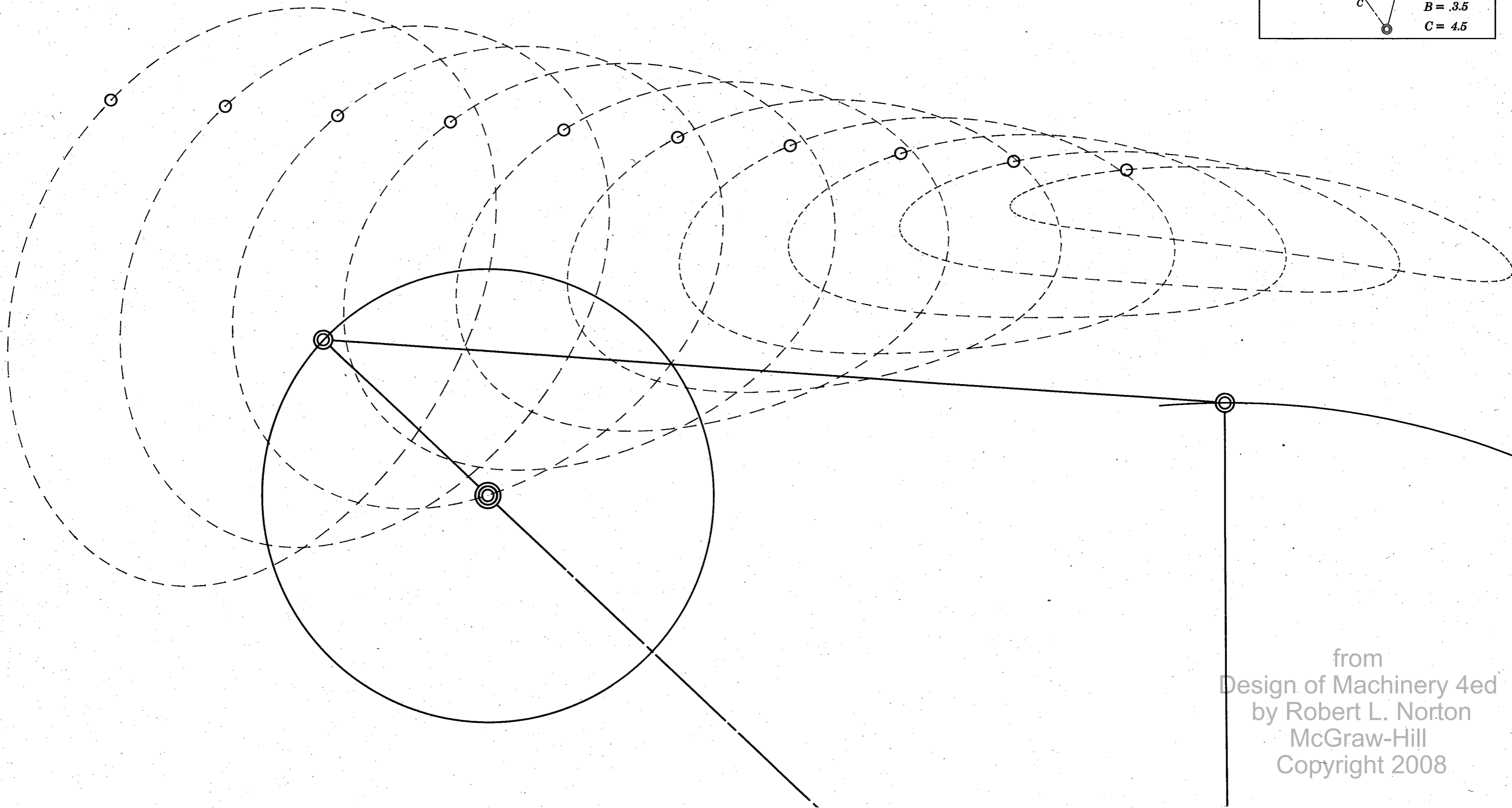
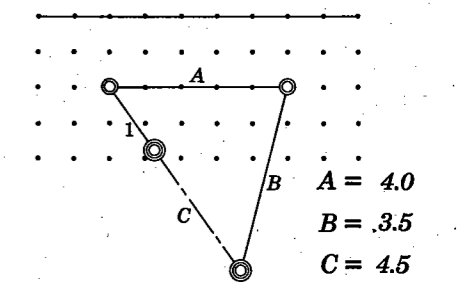

from  
Design of Machinery 4ed  
by Robert L. Norton  
McGraw-Hill  
Copyright 2008

**Analysis of the Four Bar Linkage**  
*J. A. Hrones and G. L. Nelson*

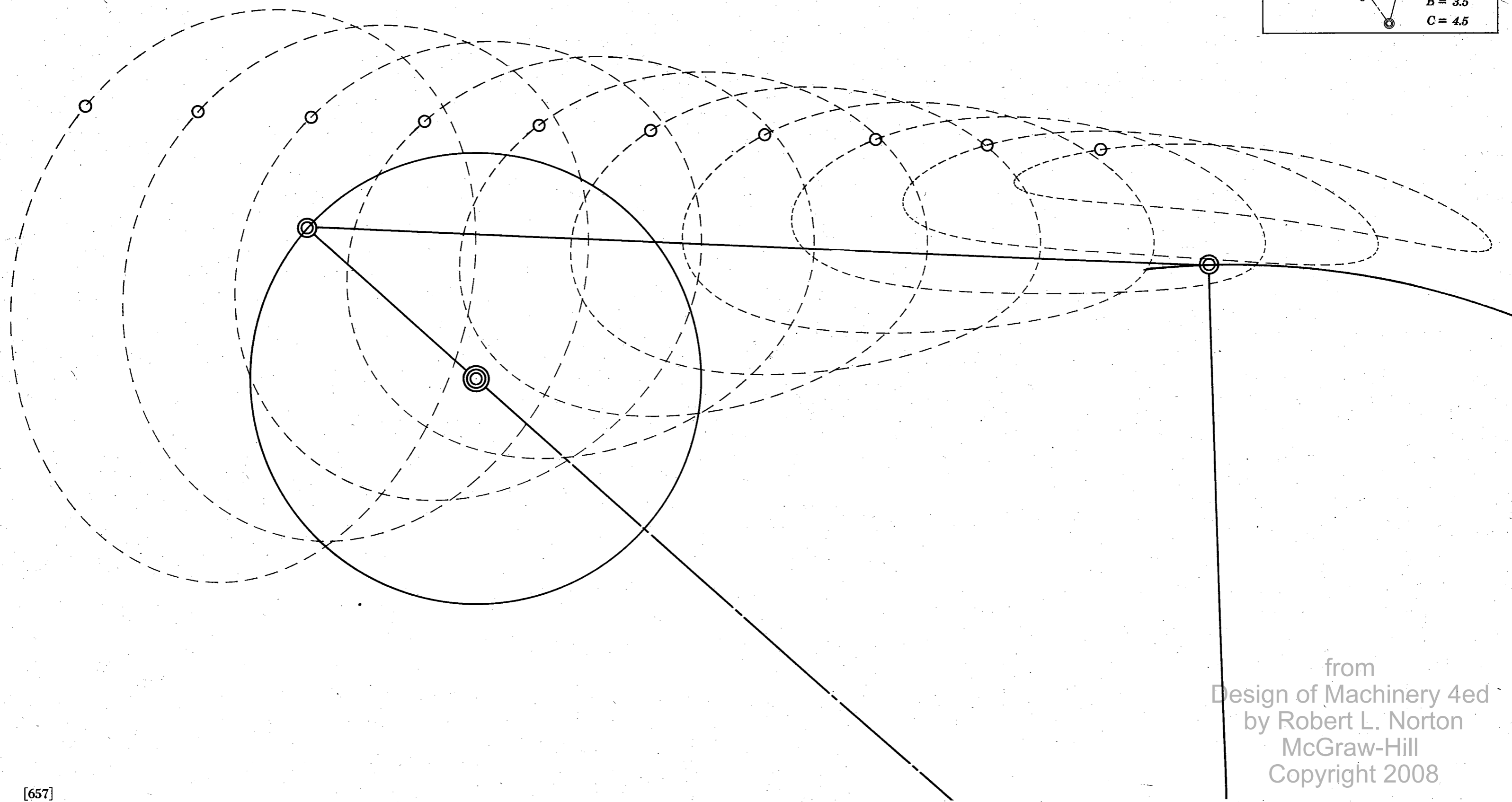
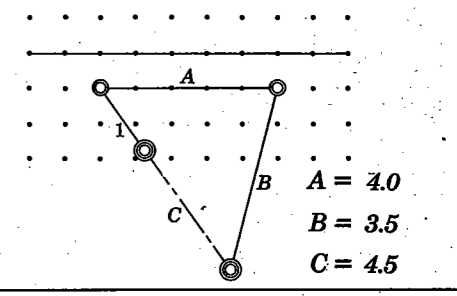

from  
Design of Machinery 4ed  
by Robert L. Norton  
McGraw-Hill  
Copyright 2008

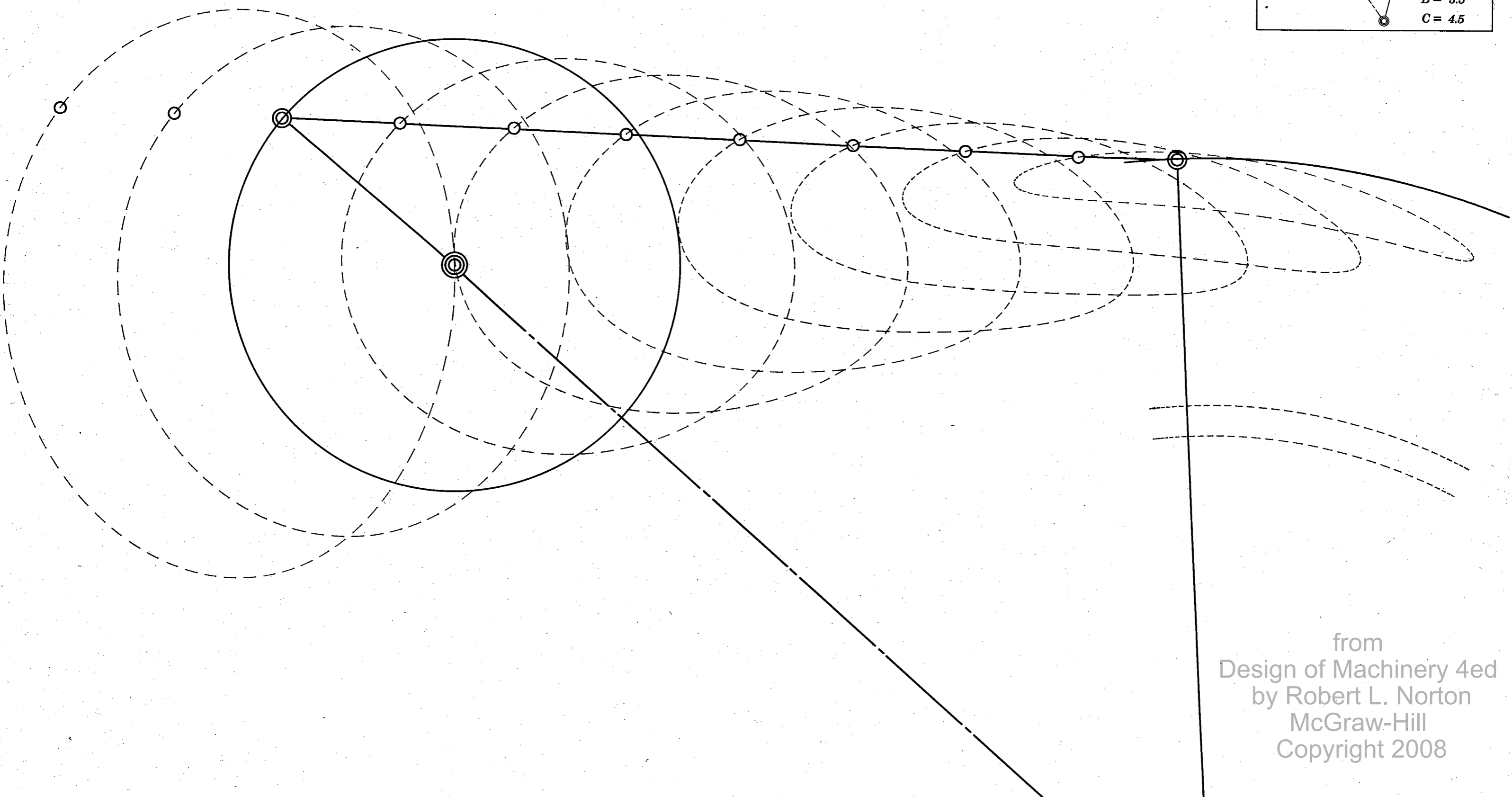
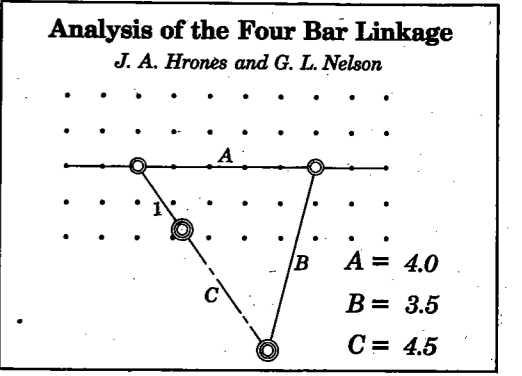

from  
Design of Machinery 4ed  
by Robert L. Norton  
McGraw-Hill  
Copyright 2008

**Analysis of the Four Bar Linkage**

*J. A. Hrones and G. L. Nelson*

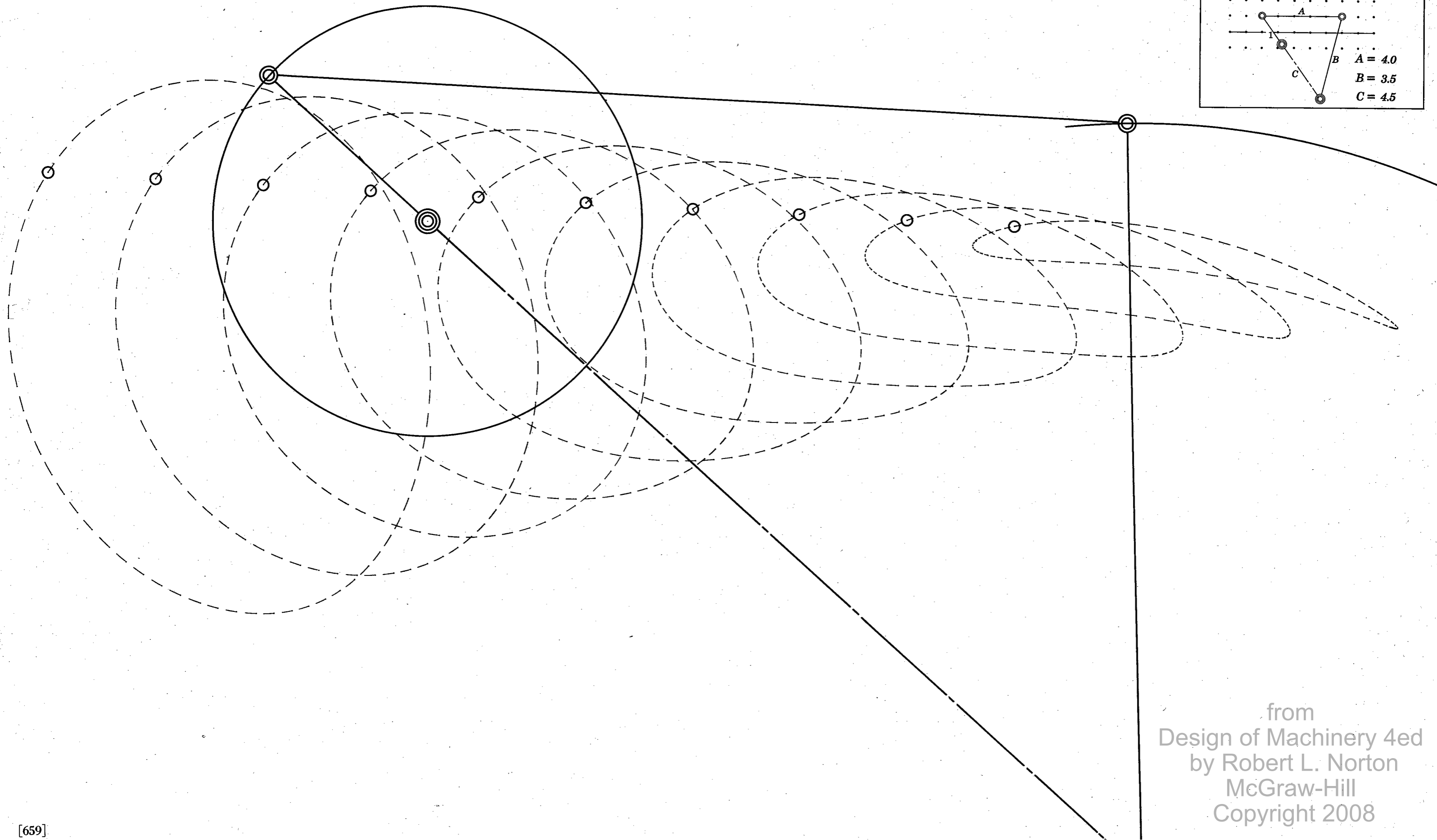
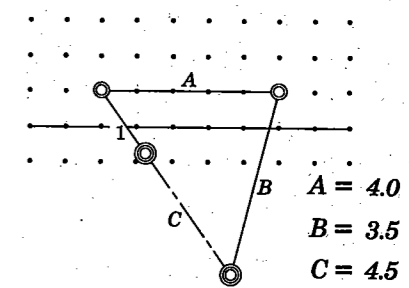

from  
Design of Machinery 4ed  
by Robert L. Norton  
McGraw-Hill  
Copyright 2008



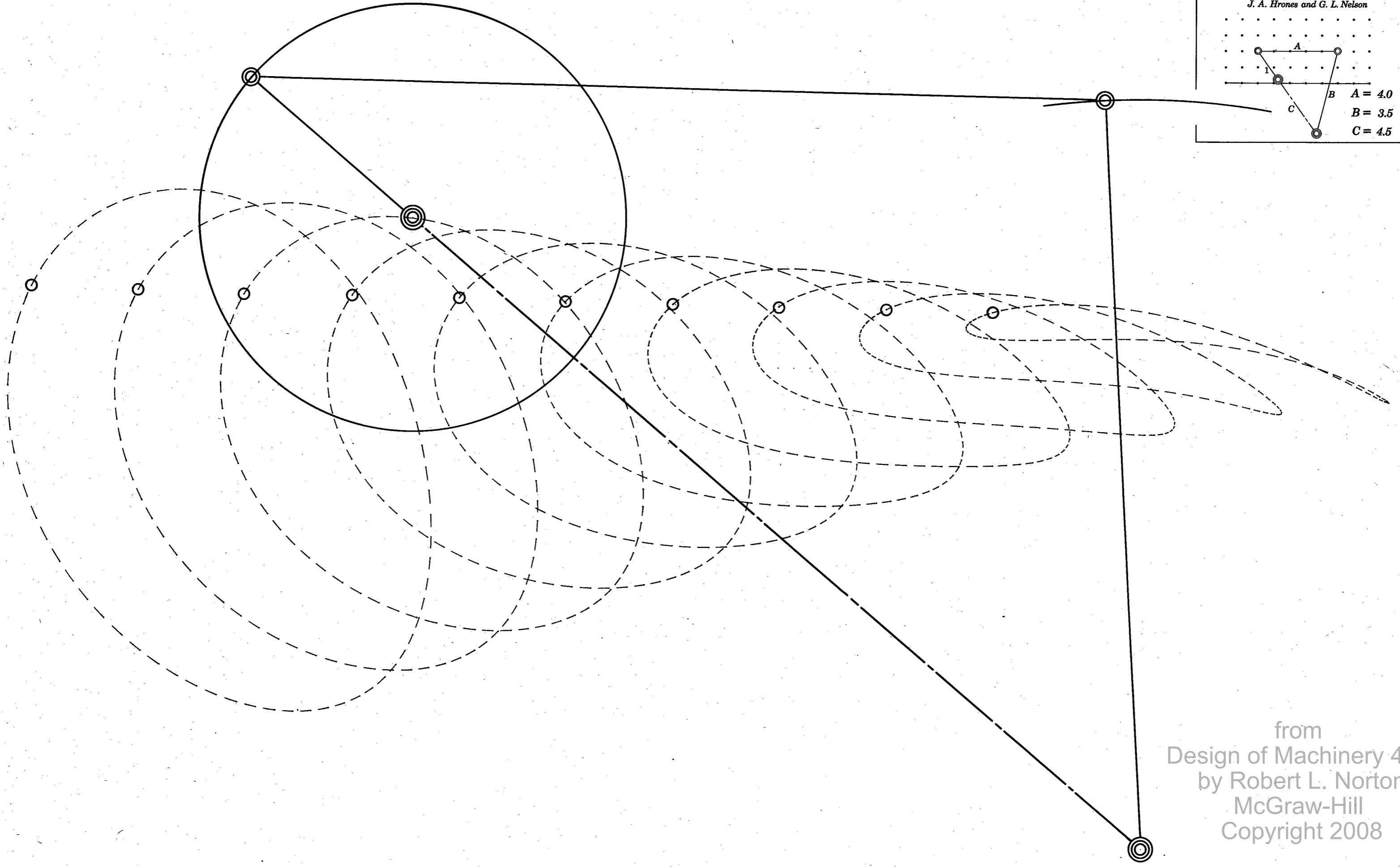
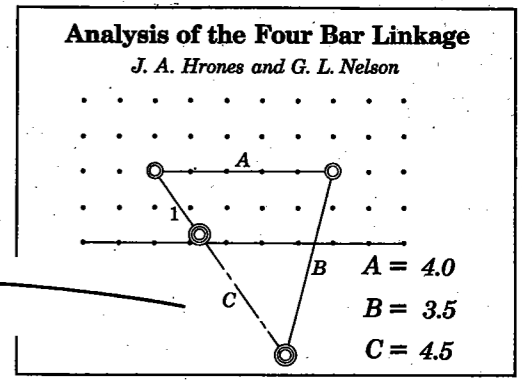

from  
Design of Machinery 4ed  
by Robert L. Norton  
McGraw-Hill  
Copyright 2008

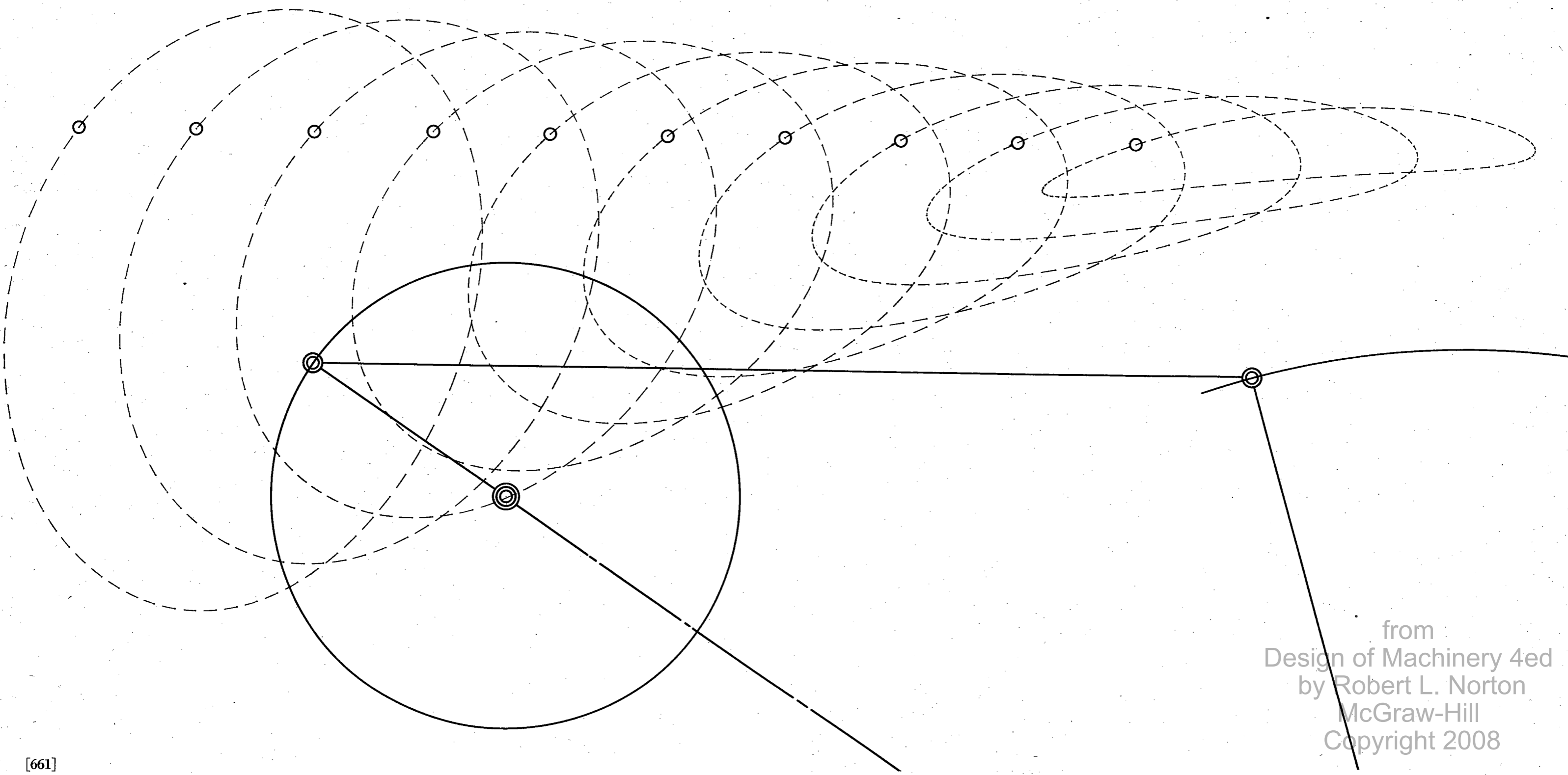
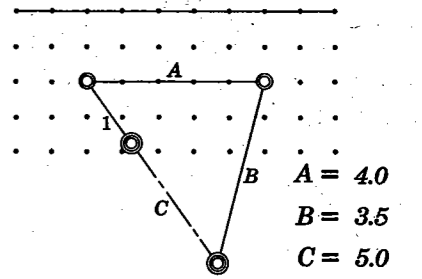

from  
 Design of Machinery 4ed  
 by Robert L. Norton  
 McGraw-Hill  
 Copyright 2008

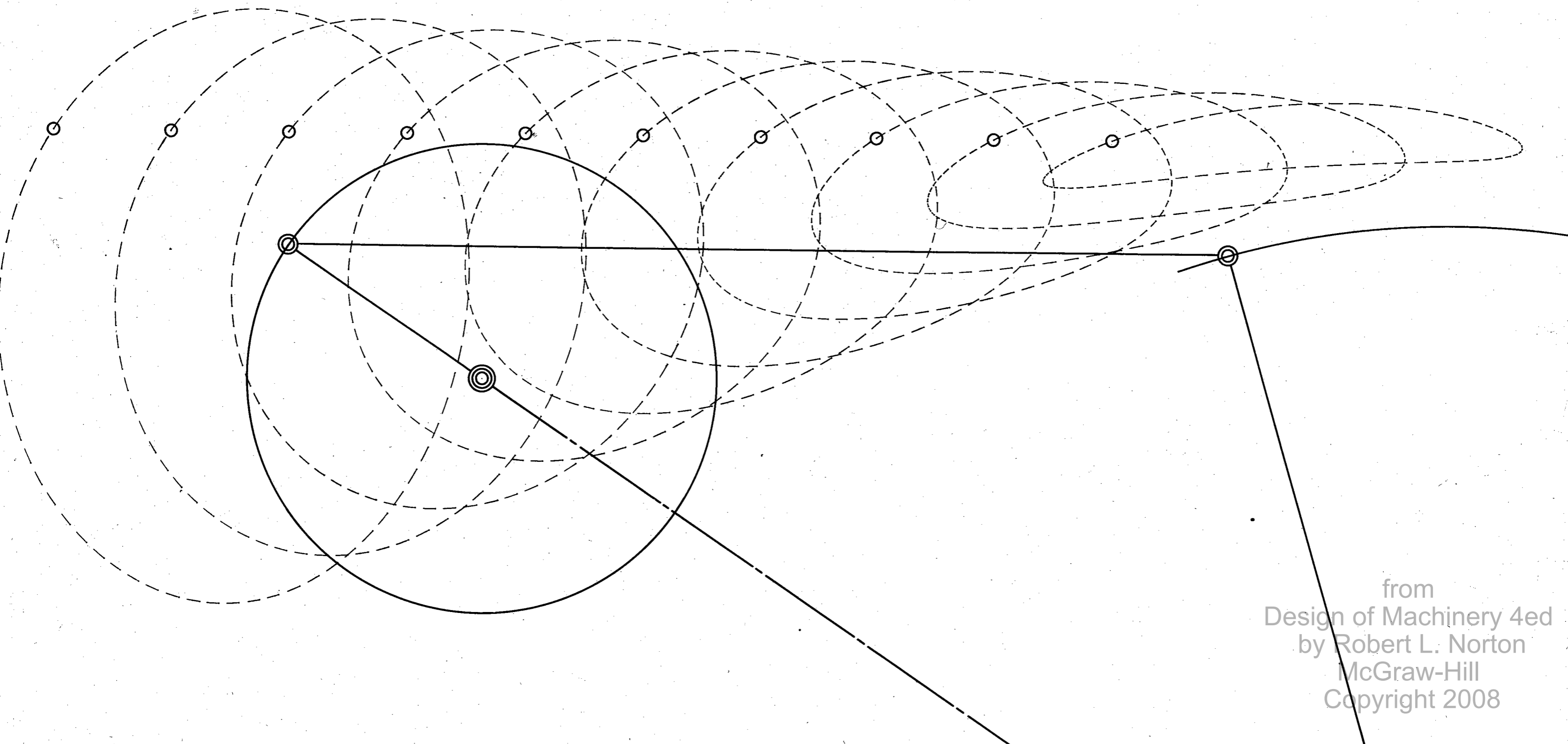
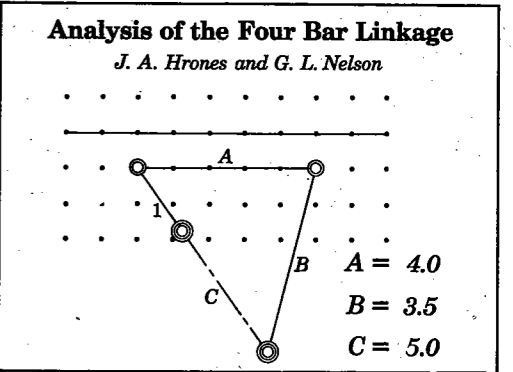

from  
Design of Machinery 4ed  
by Robert L. Norton  
McGraw-Hill  
Copyright 2008

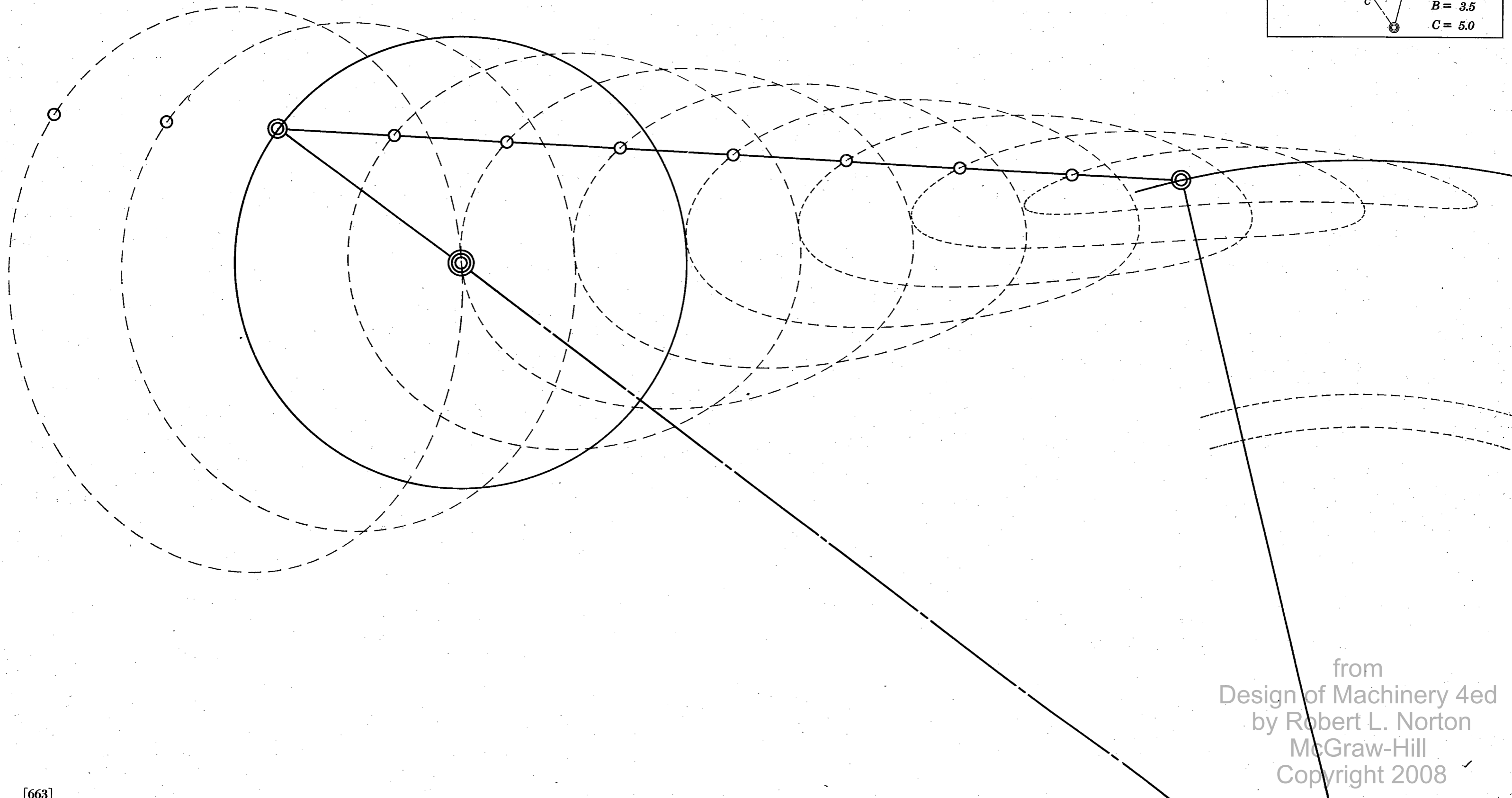
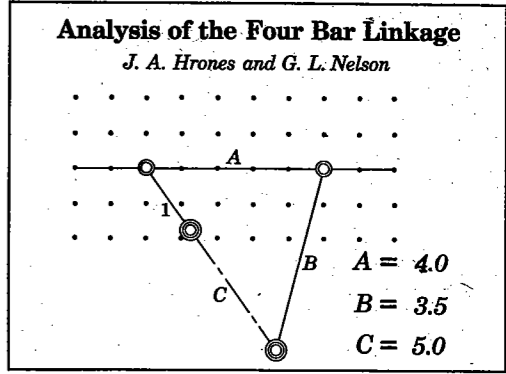

from  
 Design of Machinery 4ed  
 by Robert L. Norton  
 McGraw-Hill  
 Copyright 2008

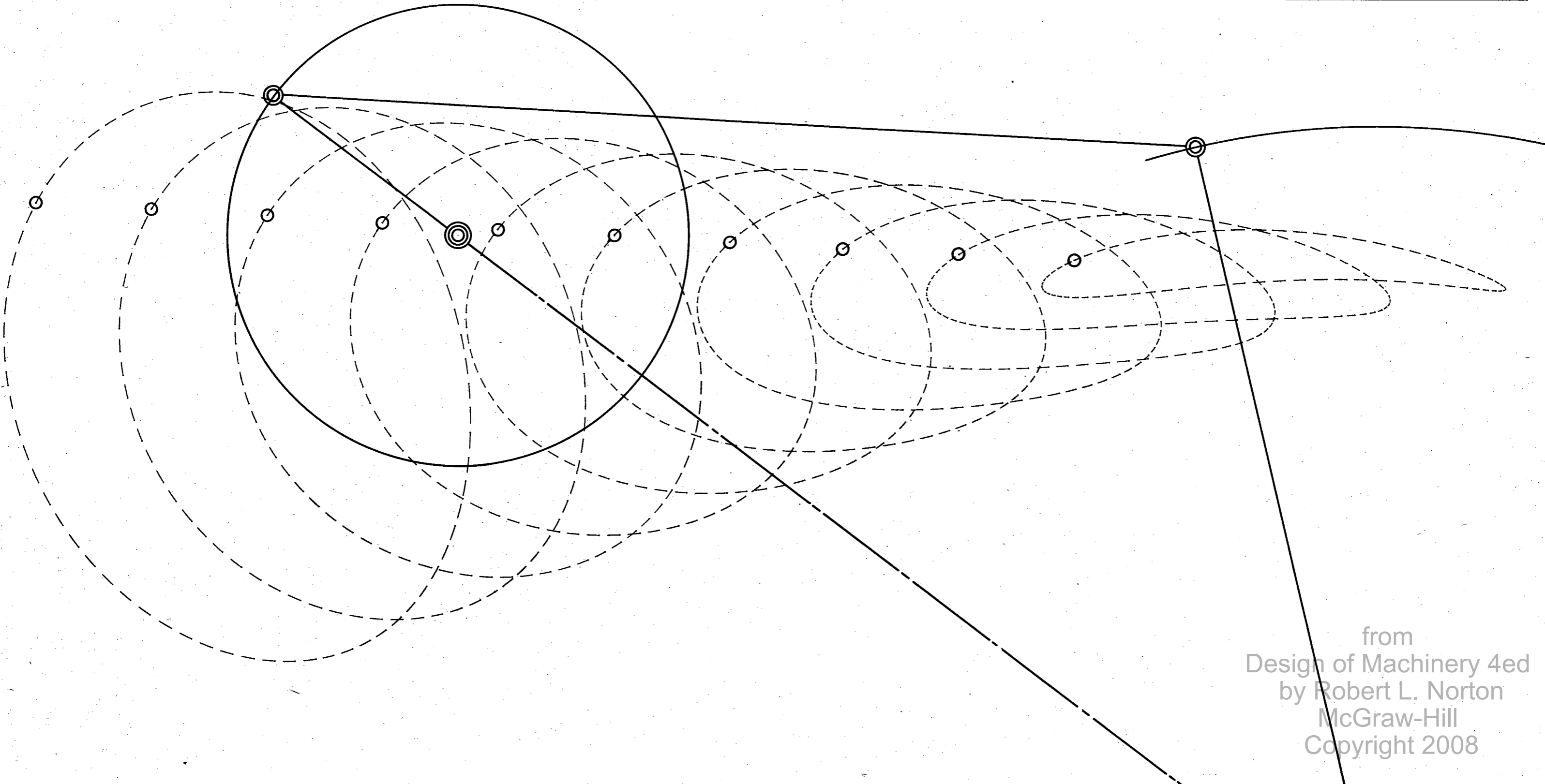
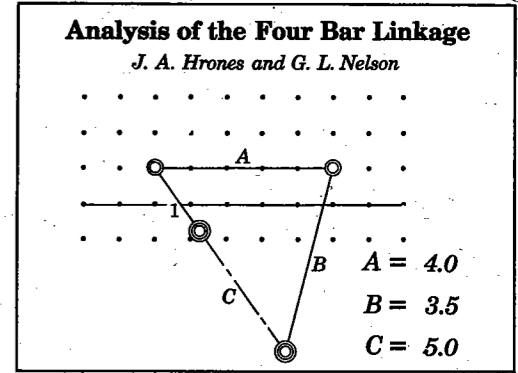

from  
Design of Machinery 4ed  
by Robert L. Norton  
McGraw-Hill  
Copyright 2008

**Analysis of the Four Bar Linkage**  
*J. A. Hrones and G. L. Nelson*

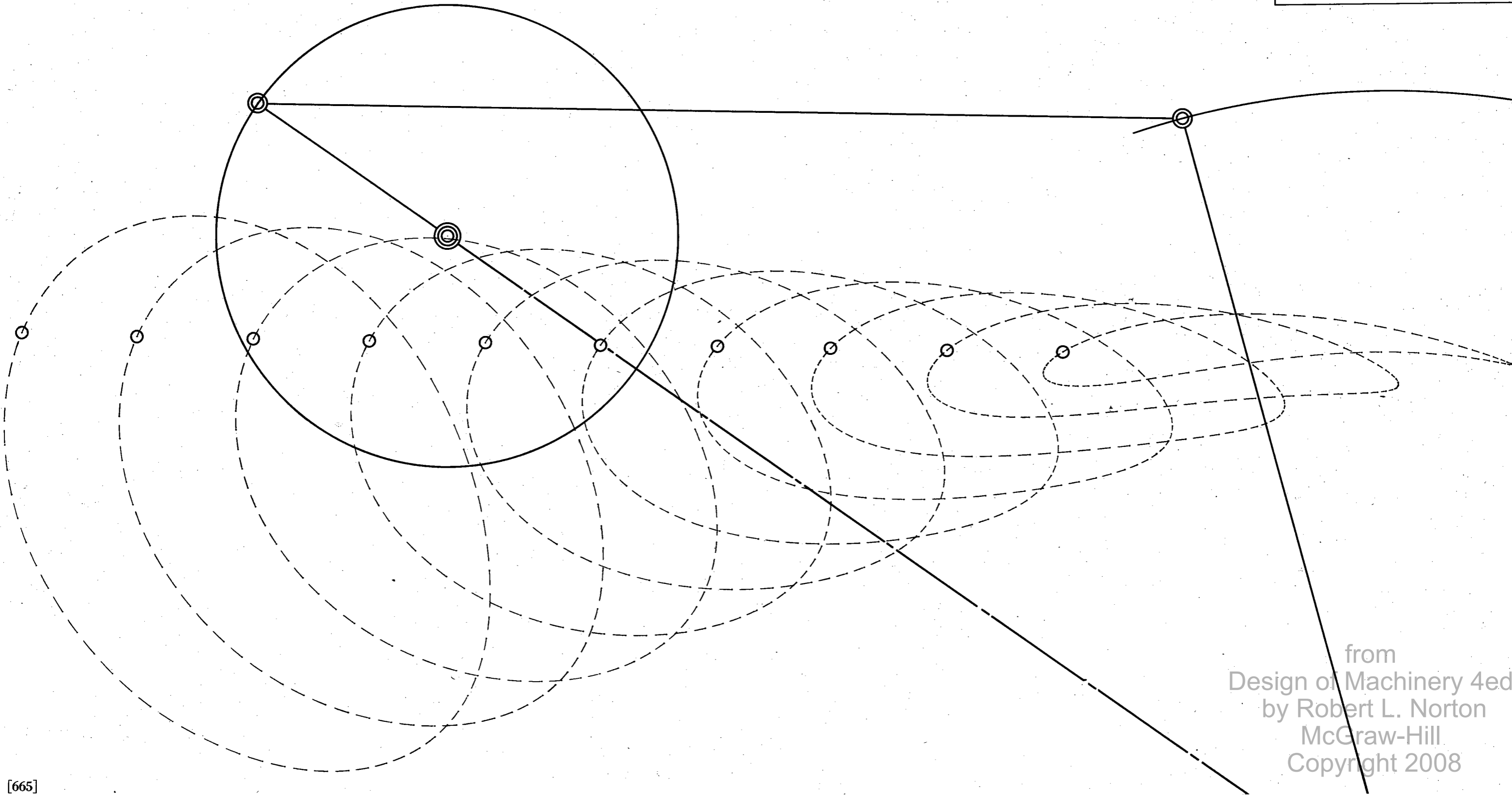
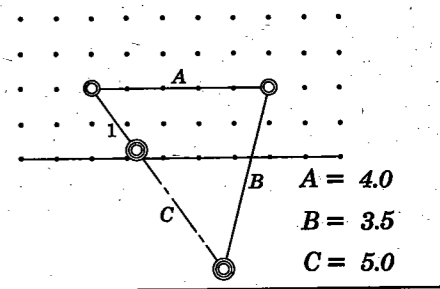

from  
Design of Machinery 4ed  
by Robert L. Norton  
McGraw-Hill  
Copyright 2008

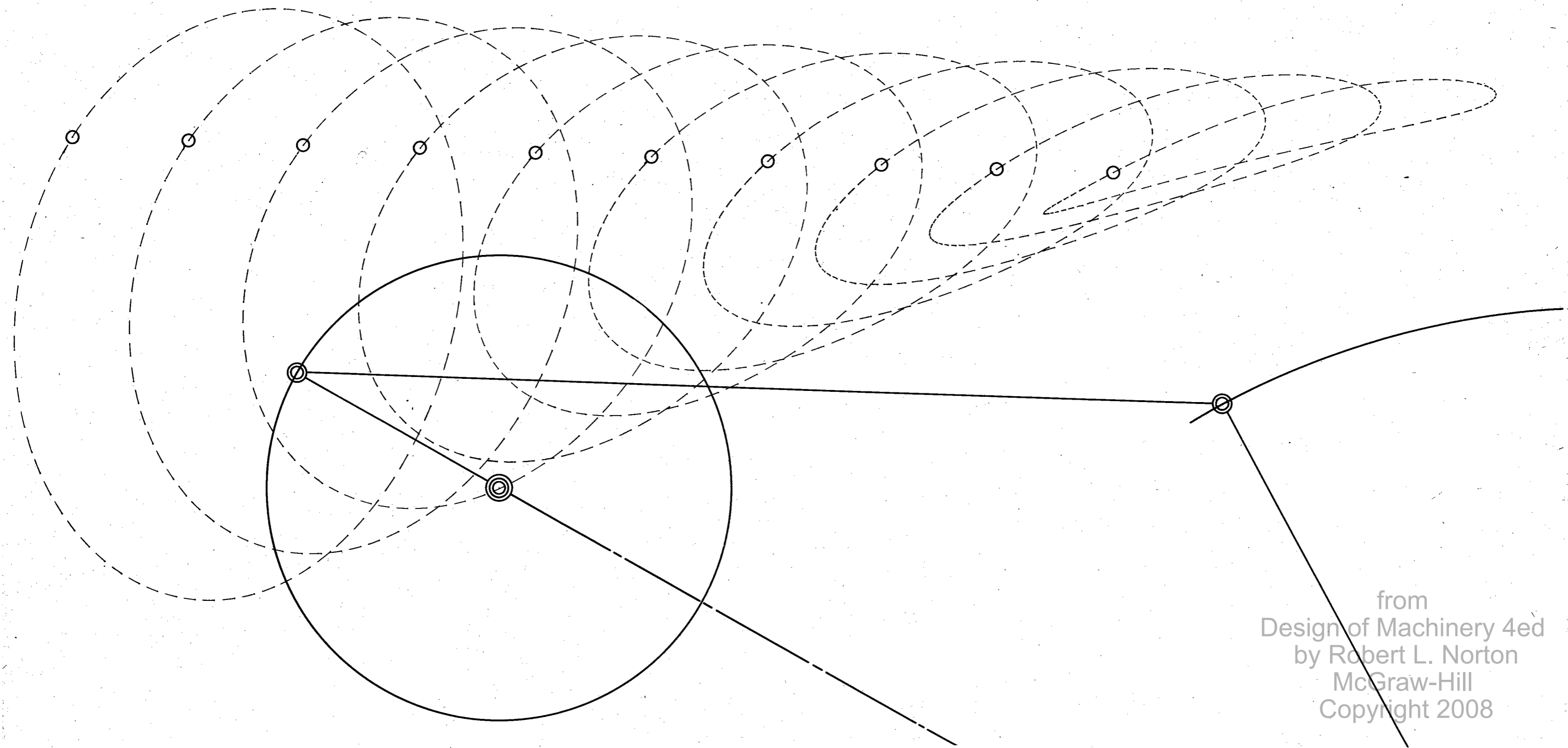
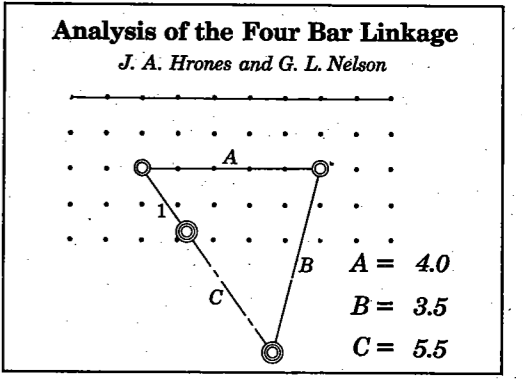

from  
Design of Machinery 4ed  
by Robert L. Norton  
McGraw-Hill  
Copyright 2008

**Analysis of the Four Bar Linkage**

*J. A. Hrones and G. L. Nelson*

.....

-----

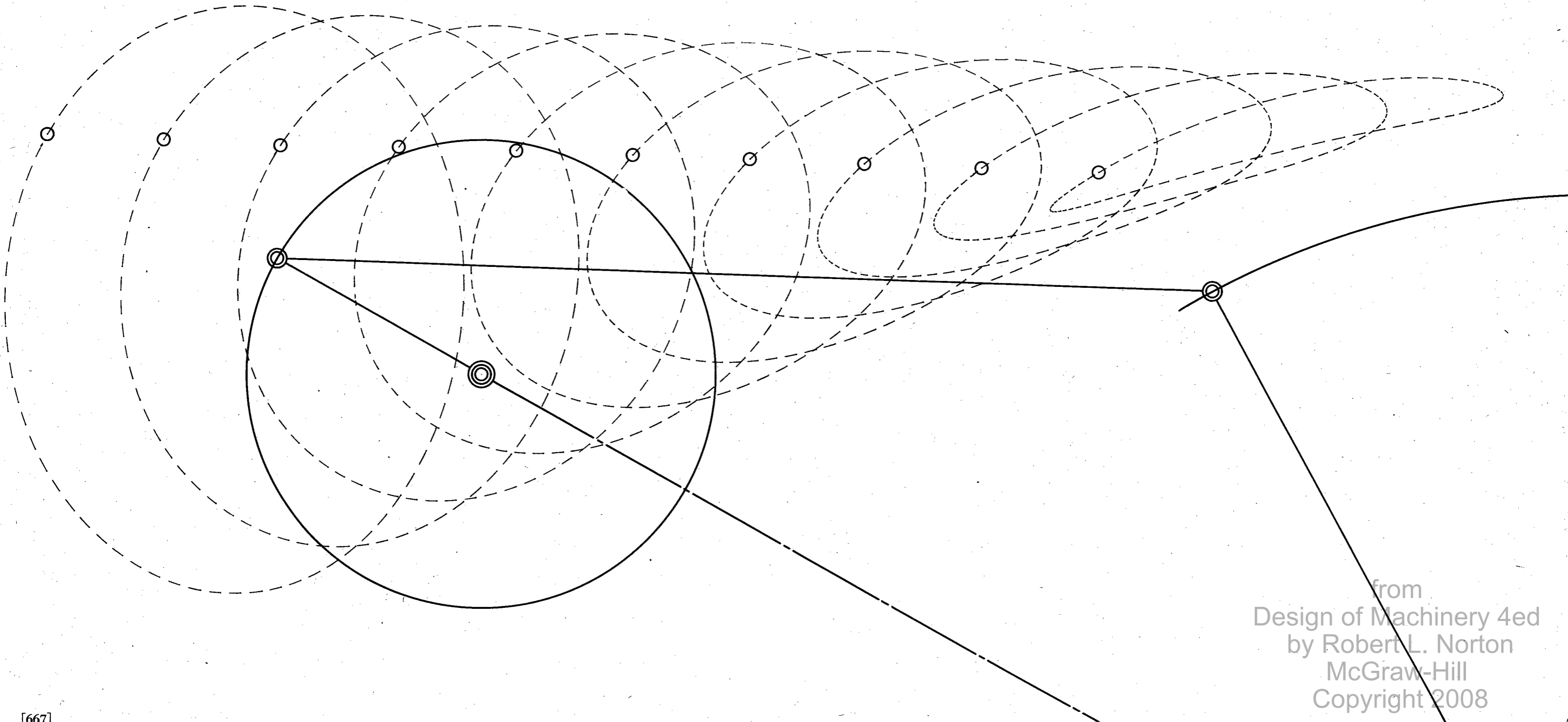
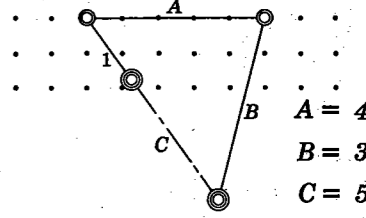

from  
Design of Machinery 4ed  
by Robert L. Norton  
McGraw-Hill  
Copyright 2008



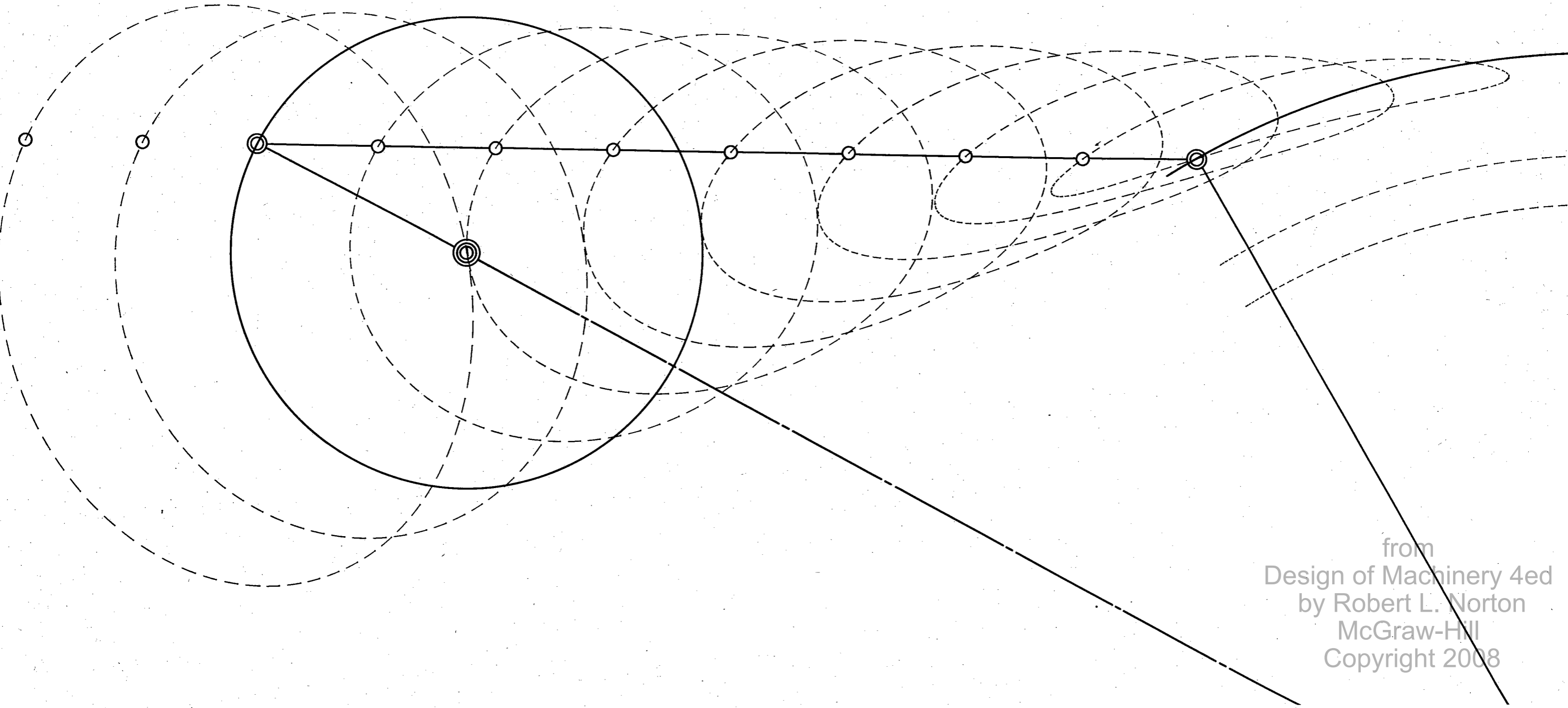
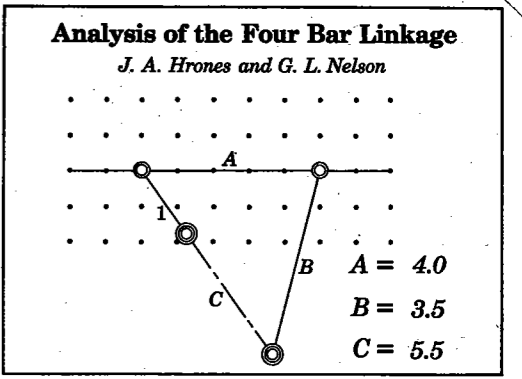

from  
Design of Machinery 4ed  
by Robert L. Norton  
McGraw-Hill  
Copyright 2008

**Analysis of the Four Bar Linkage**

*J. A. Hrones and G. L. Nelson*

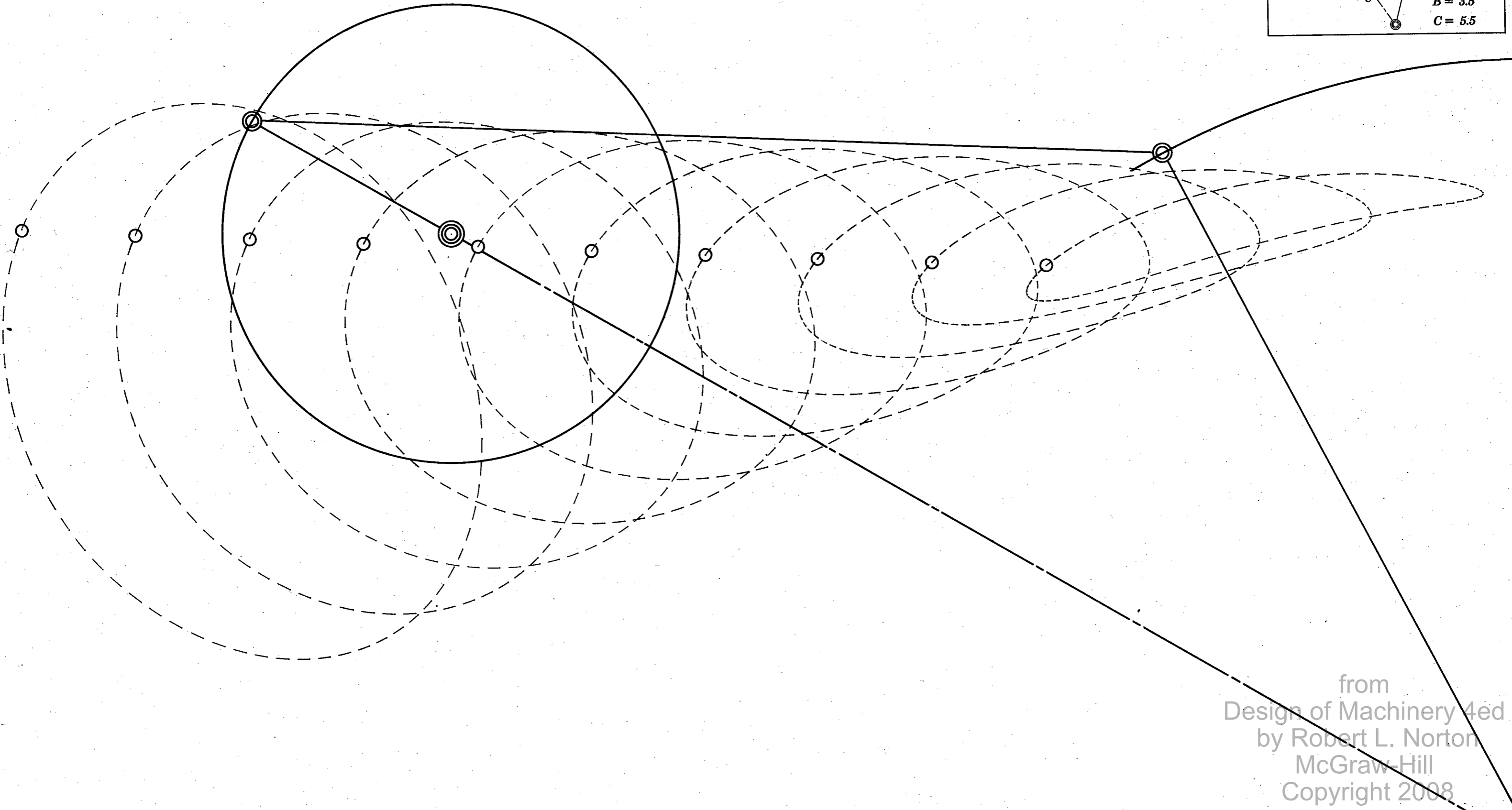
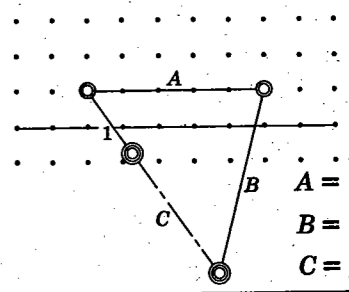

from  
Design of Machinery 4ed  
by Robert L. Norton  
McGraw-Hill  
Copyright 2008

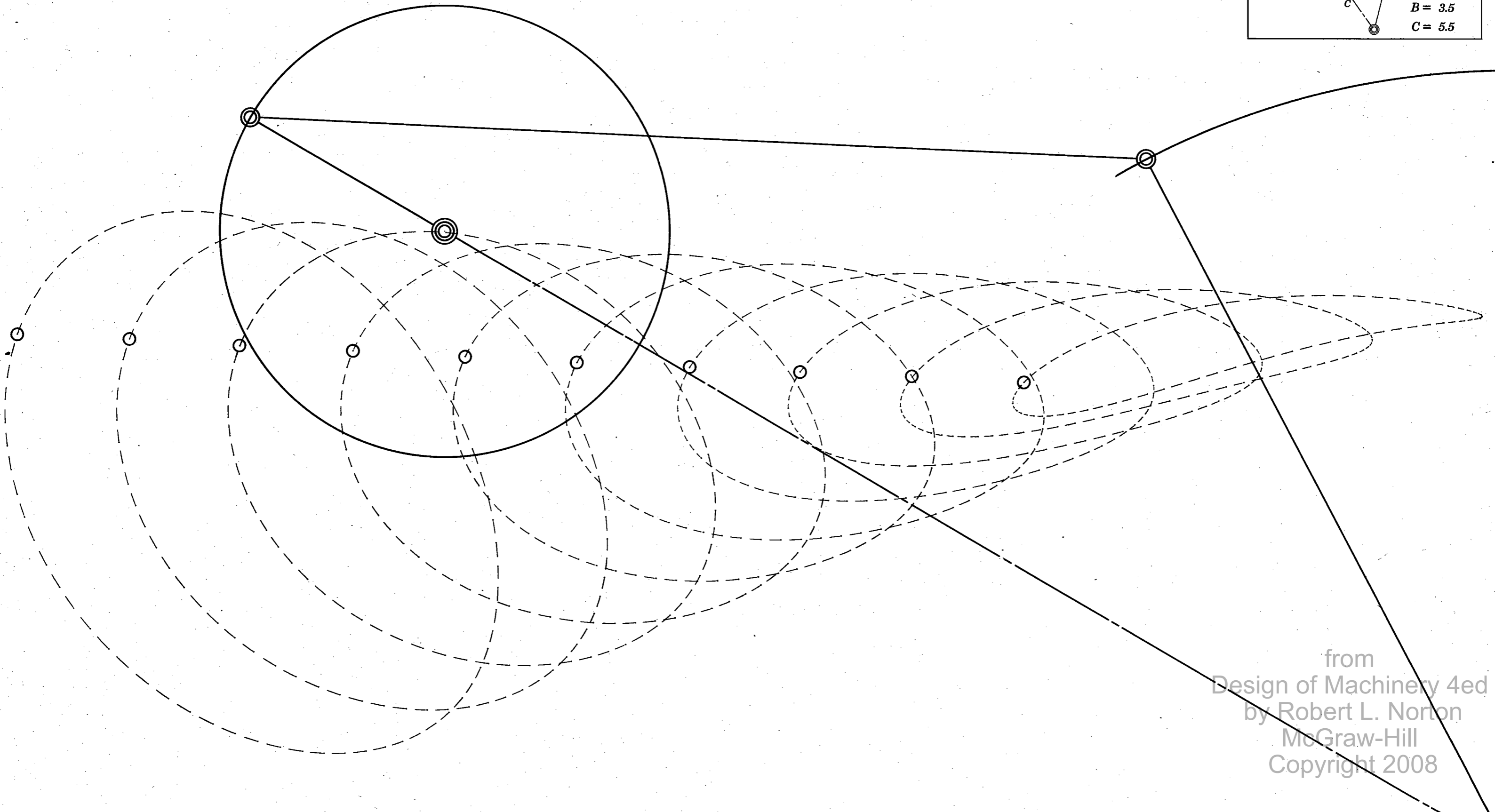
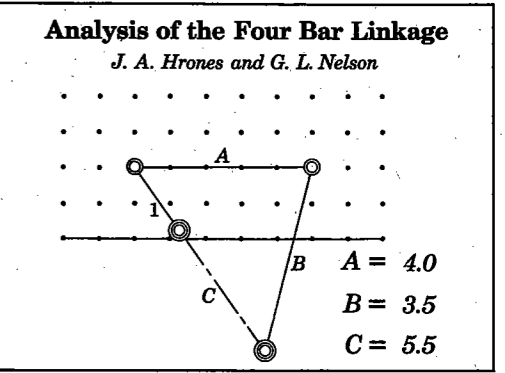

from  
Design of Machinery 4ed  
by Robert L. Norton  
McGraw-Hill  
Copyright 2008

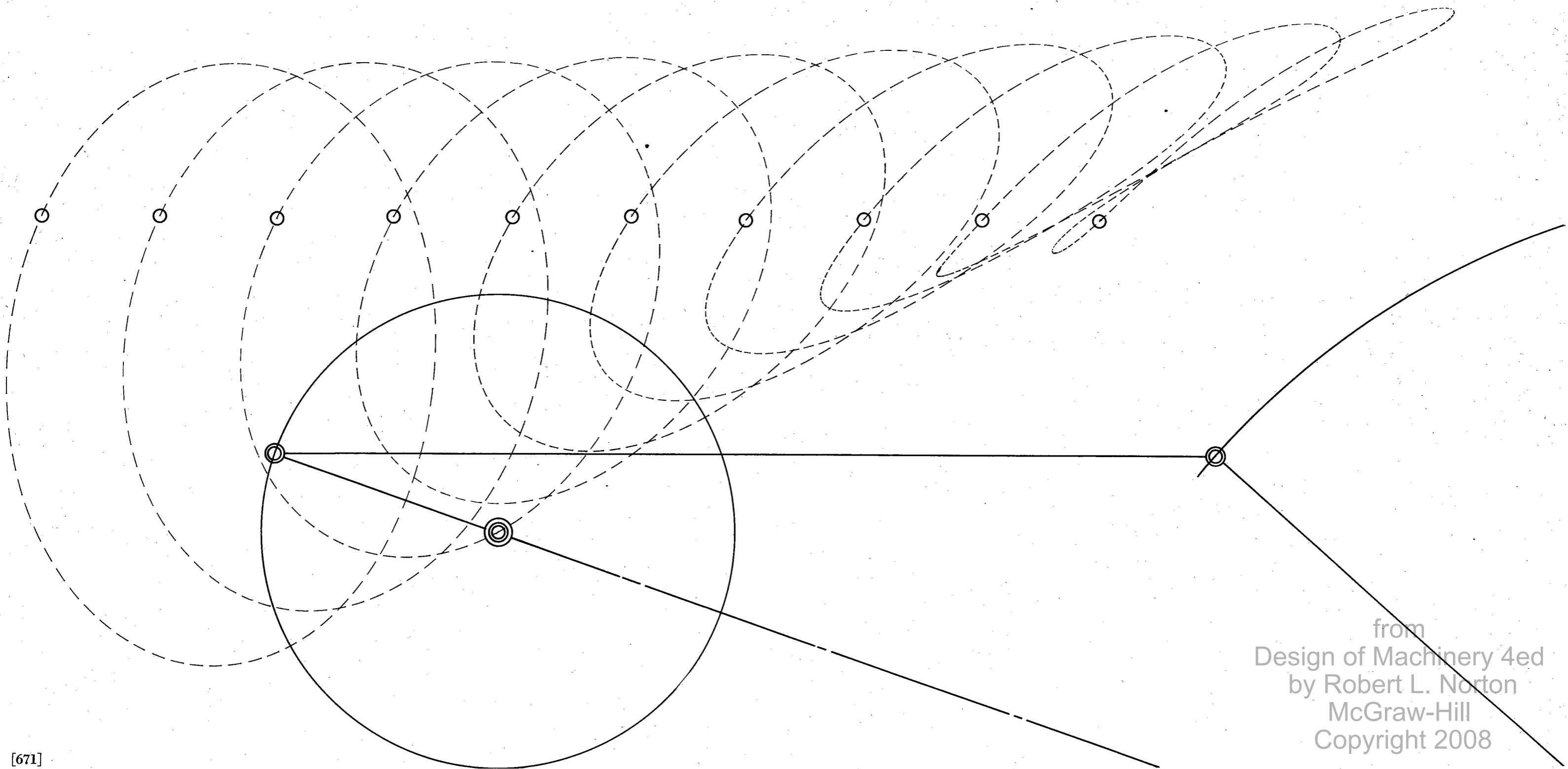
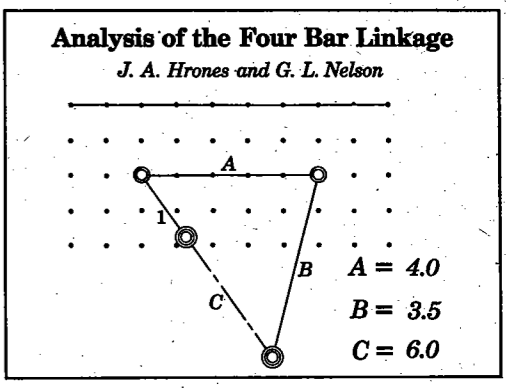

from  
 Design of Machinery 4ed  
 by Robert L. Norton  
 McGraw-Hill  
 Copyright 2008

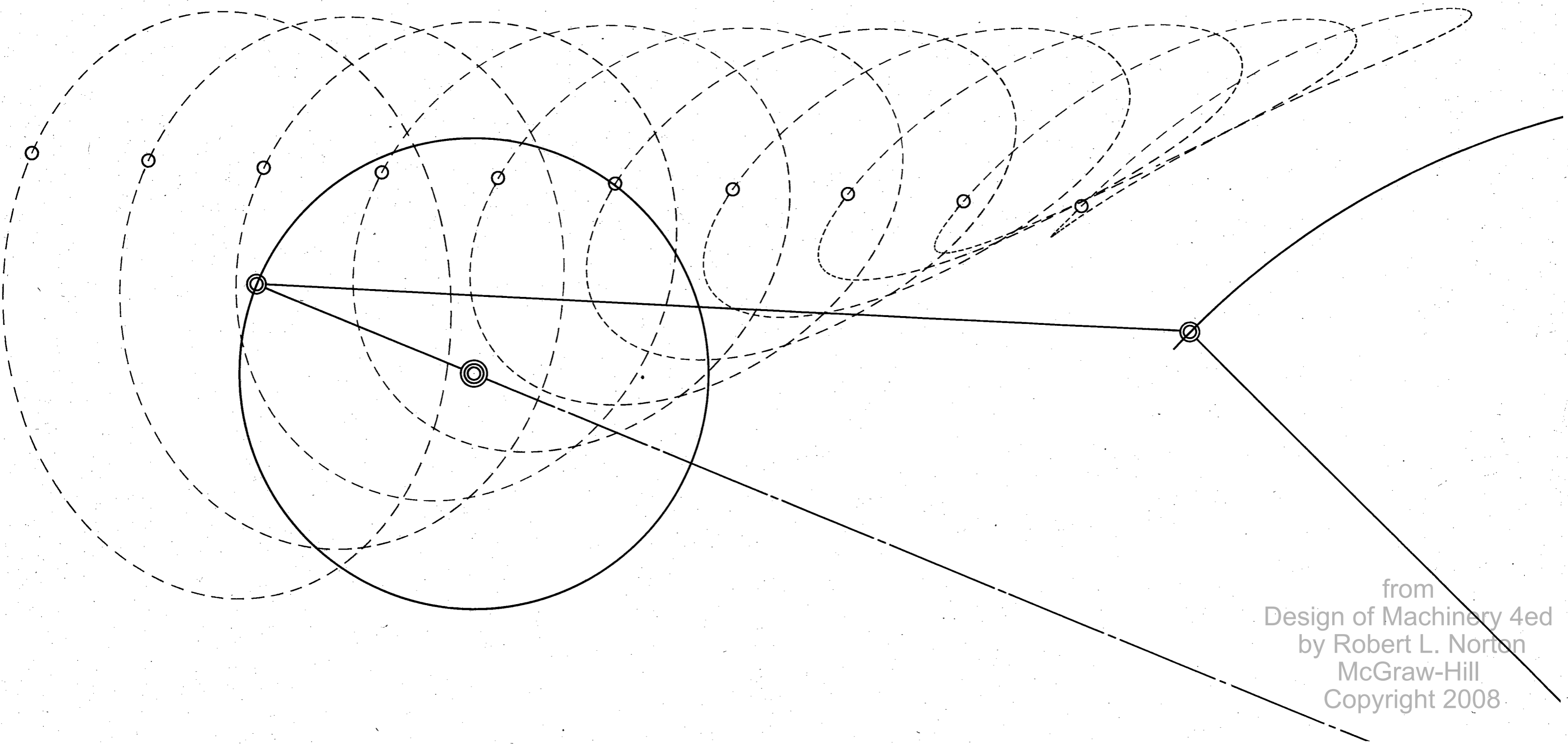
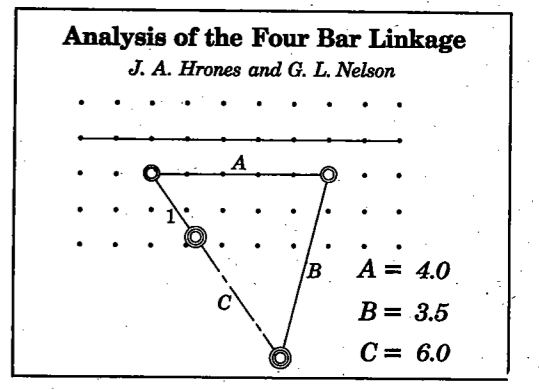

from  
Design of Machinery 4ed  
by Robert L. Norton  
McGraw-Hill  
Copyright 2008

**Analysis of the Four Bar Linkage**

*J. A. Hrones and G. L. Nelson*

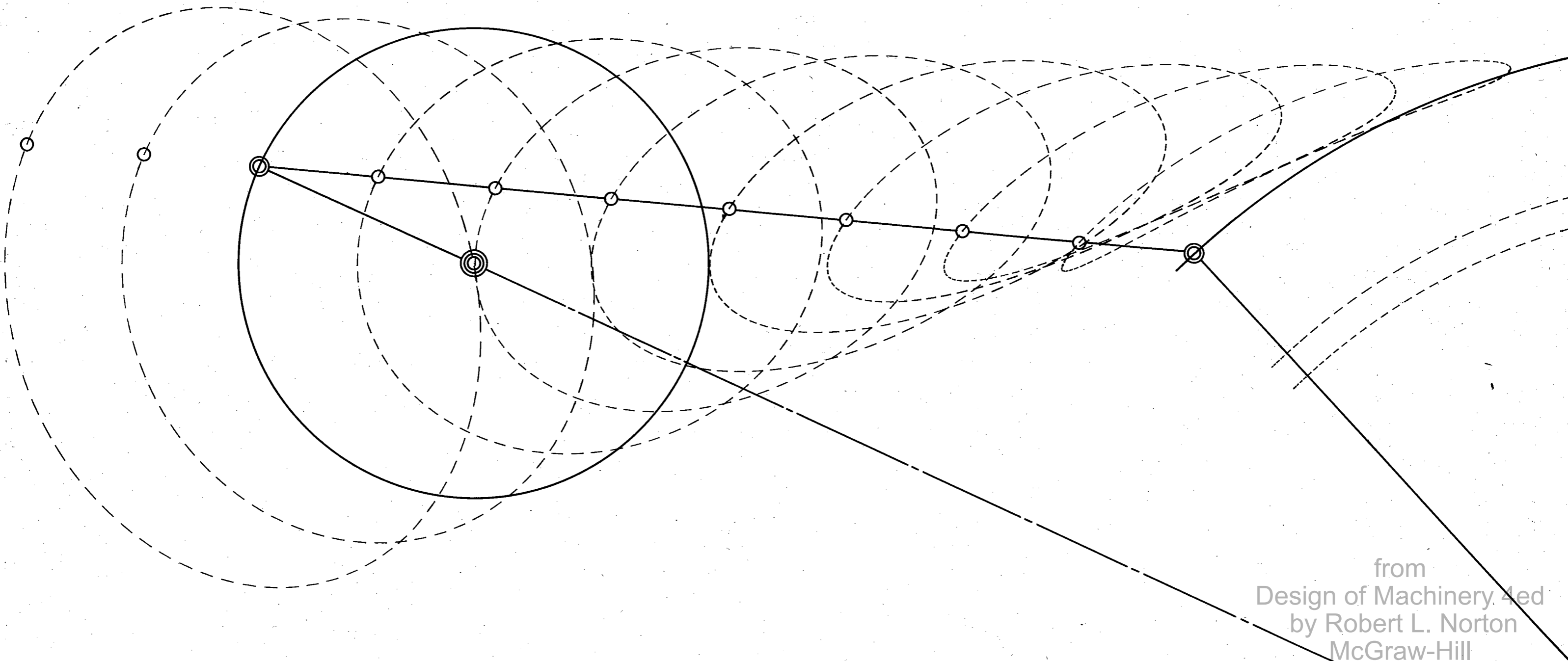
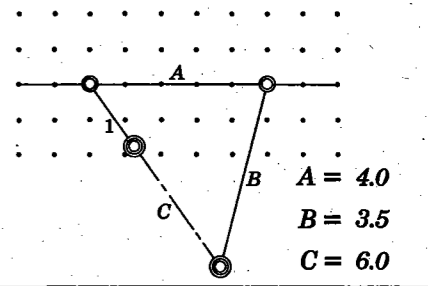

from  
Design of Machinery 4ed  
by Robert L. Norton  
McGraw-Hill  
Copyright 2008

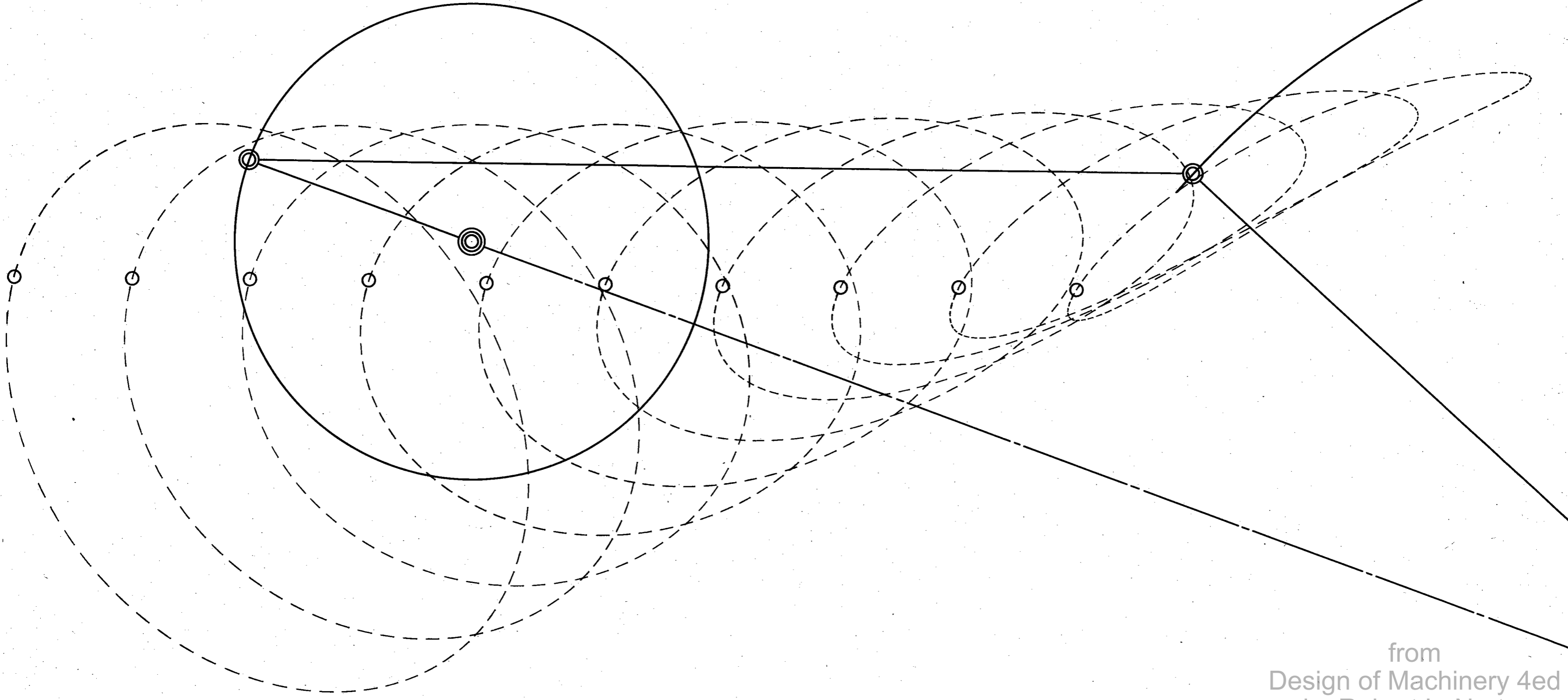
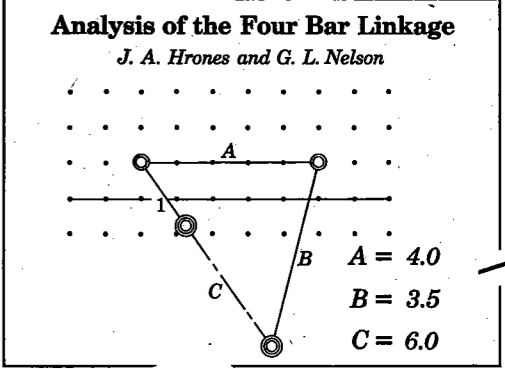

from  
Design of Machinery 4ed  
by Robert L. Norton  
McGraw-Hill  
Copyright 2008

**Analysis of the Four Bar Linkage**

*J. A. Hrones and G. L. Nelson*

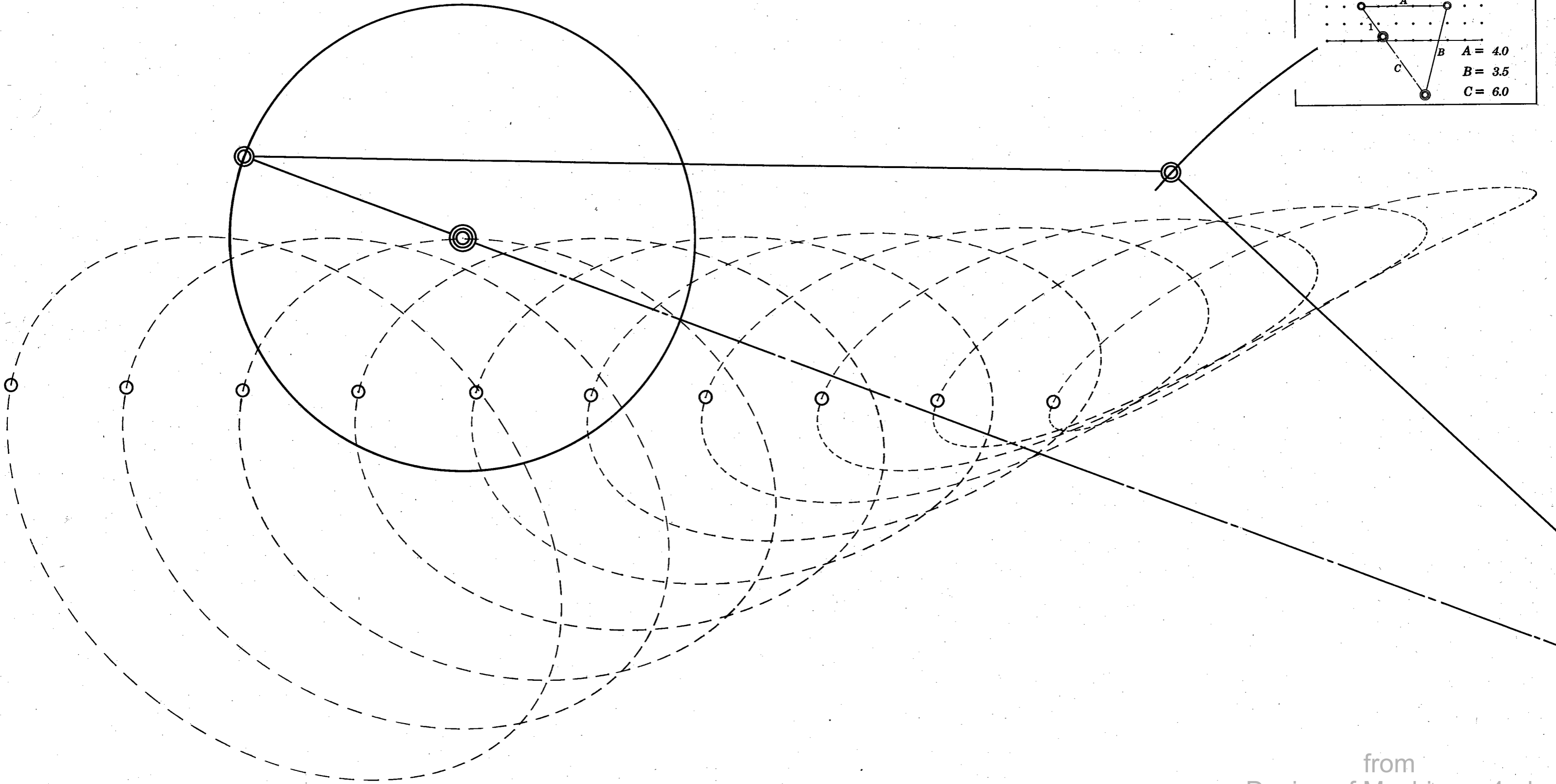
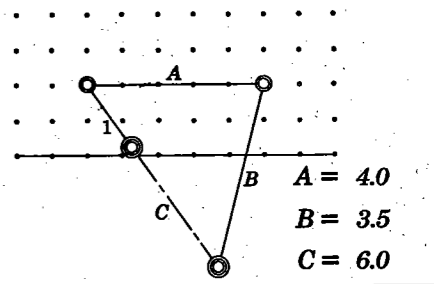

from  
Design of Machinery 4ed  
by Robert L. Norton  
McGraw-Hill  
Copyright 2008



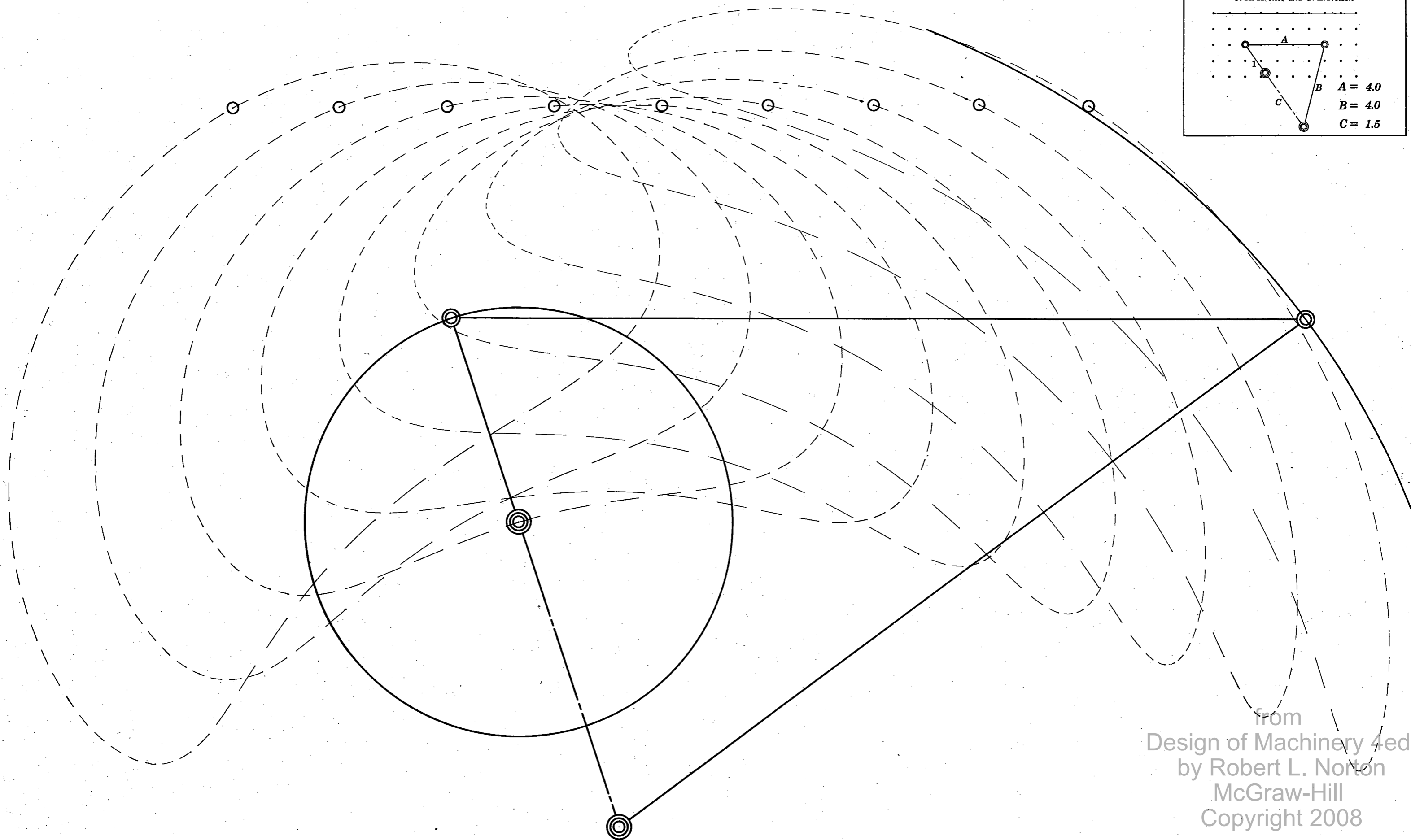
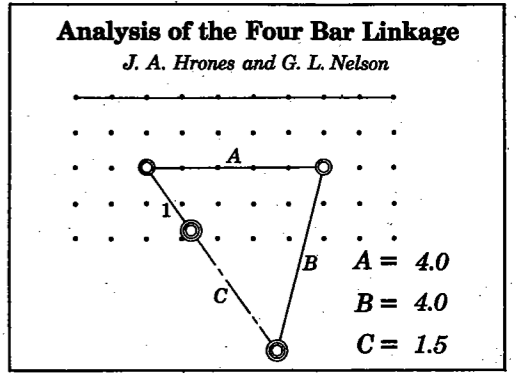

from  
Design of Machinery 4ed  
by Robert L. Norton  
McGraw-Hill  
Copyright 2008

**Analysis of the Four Bar Linkage**

*J. A. Hrones and G. L. Nelson*

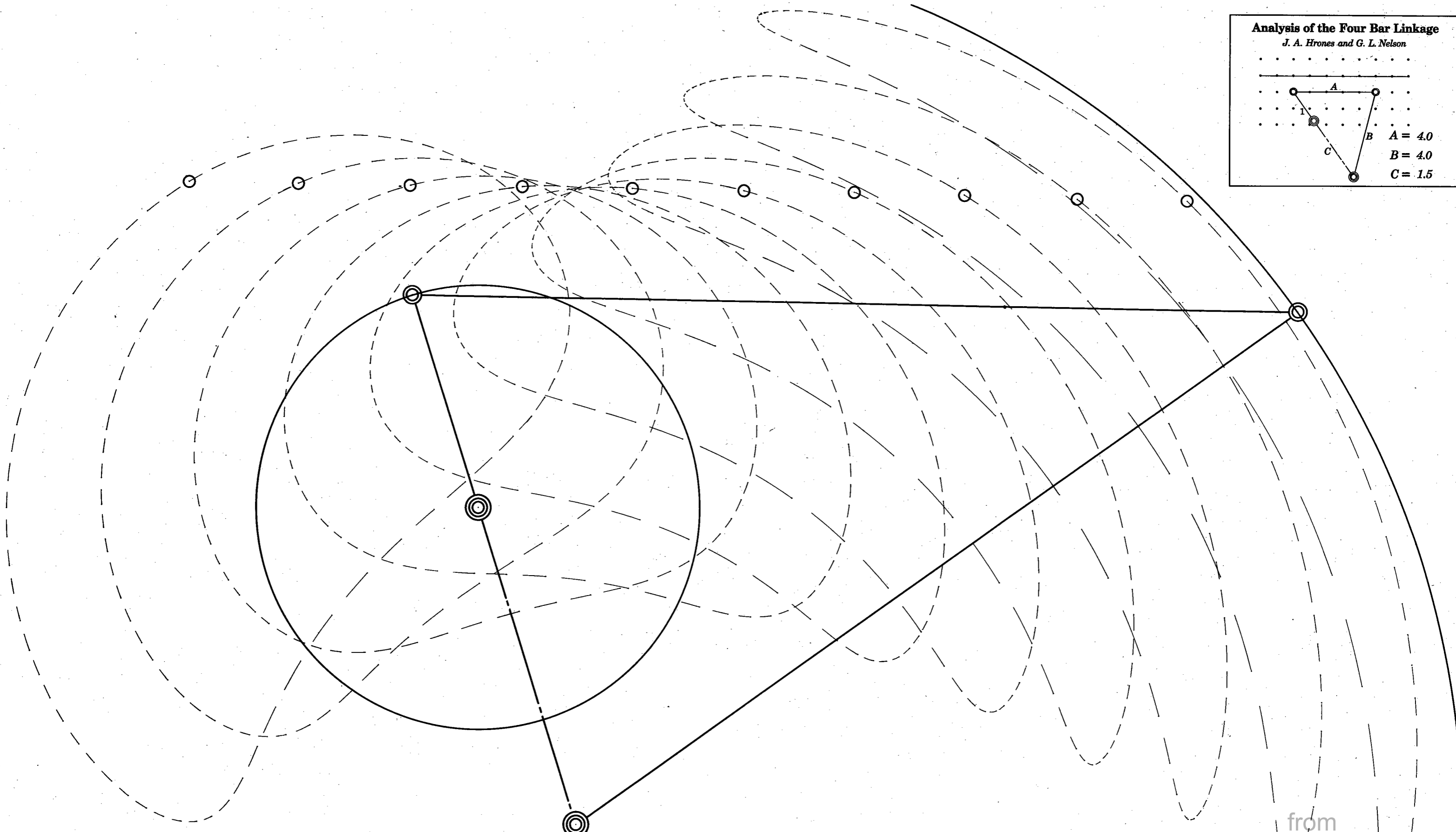
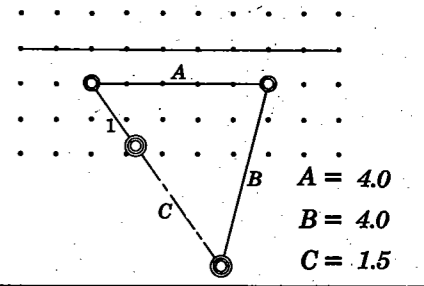

from  
Design of Machinery 4ed  
by Robert L. Norton  
McGraw-Hill  
Copyright 2008

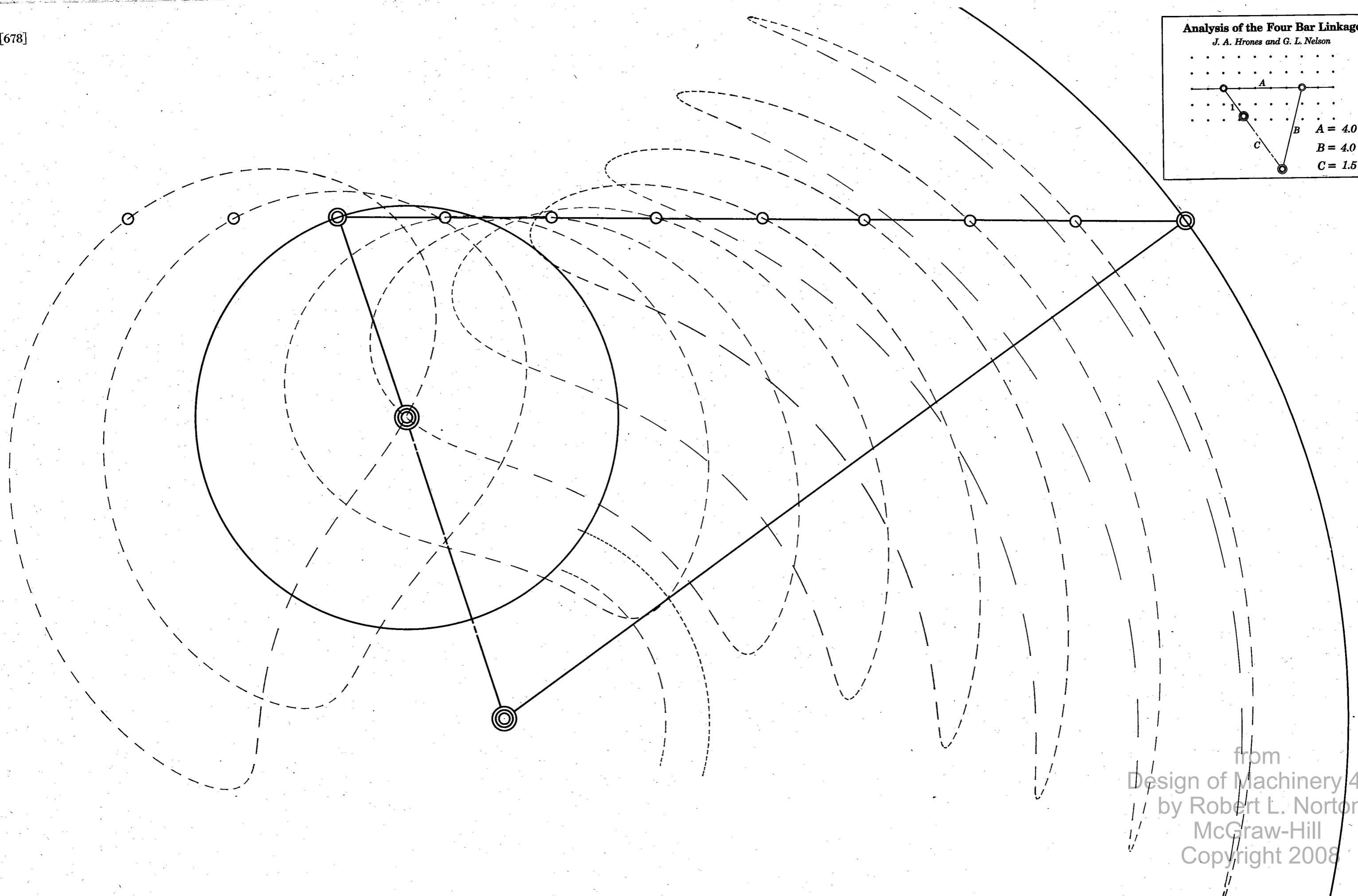
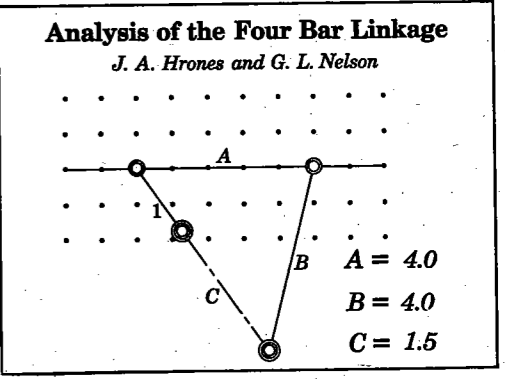

from  
Design of Machinery 4ed  
by Robert L. Norton  
McGraw-Hill  
Copyright 2008

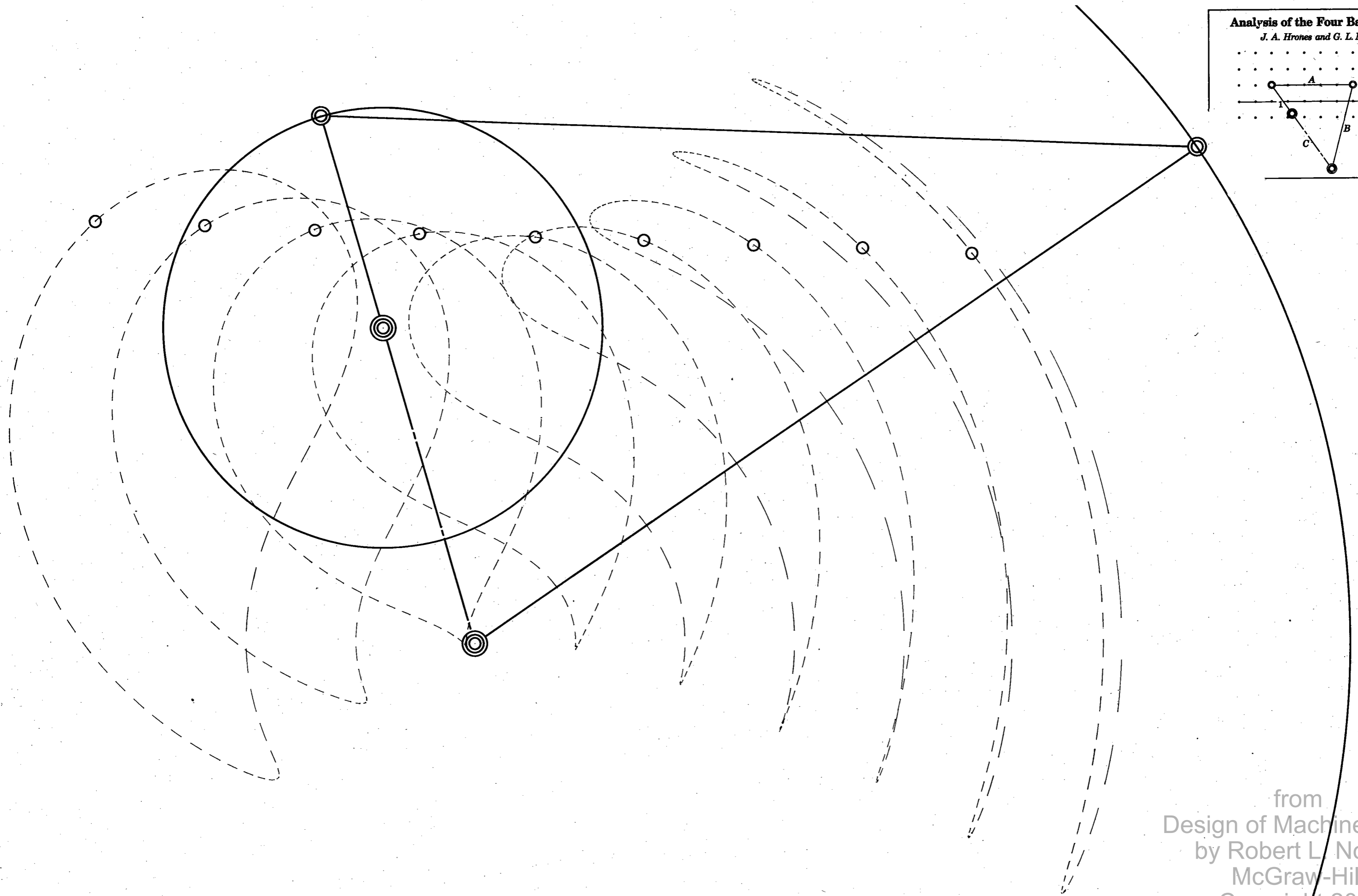
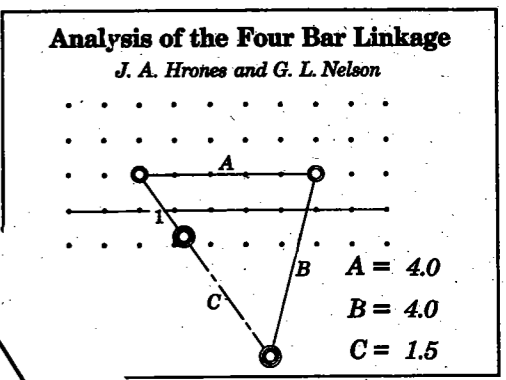

from  
Design of Machinery 4ed  
by Robert L. Norton  
McGraw-Hill  
Copyright 2008

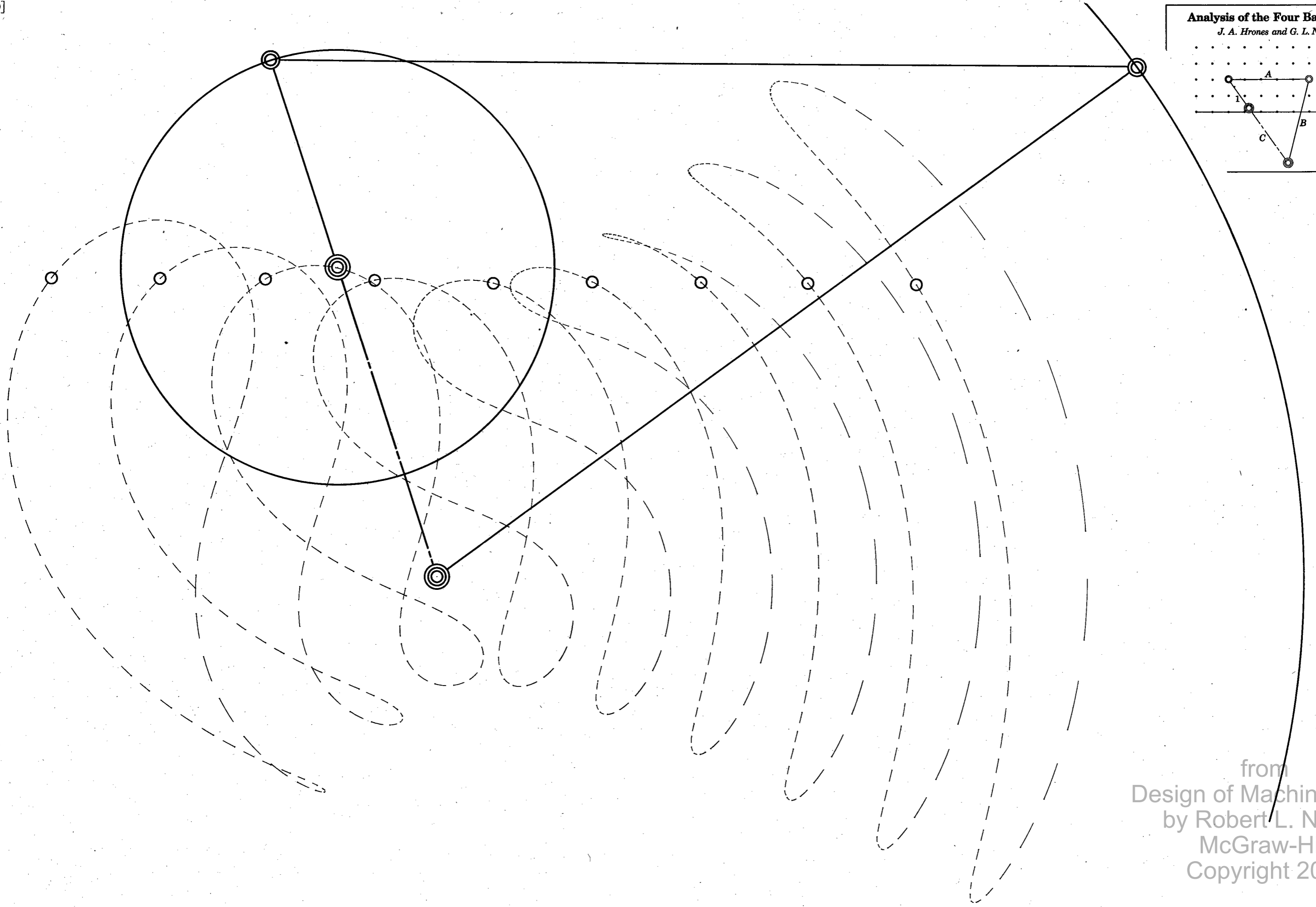
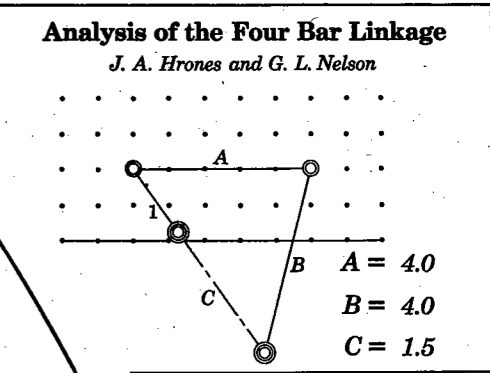

from  
Design of Machinery 4ed  
by Robert L. Norton  
McGraw-Hill  
Copyright 2008

**Analysis of the Four Bar Linkage**  
*J. A. Hrones and G. L. Nelson*

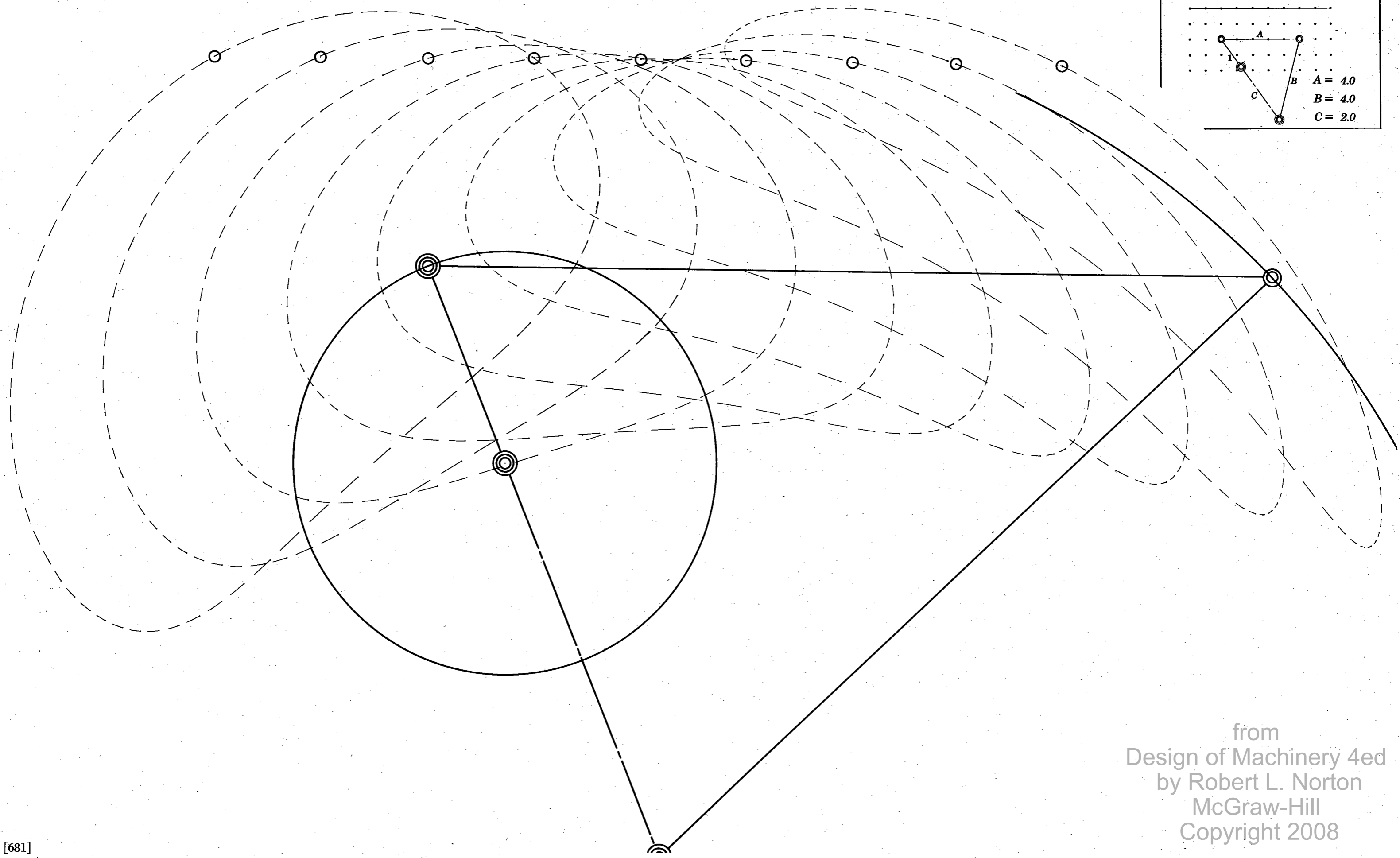
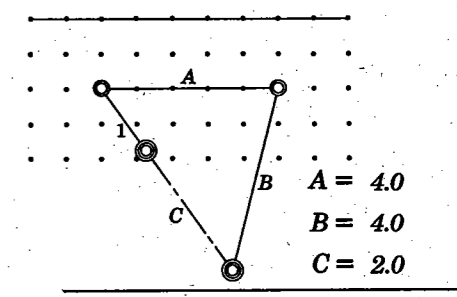

from  
 Design of Machinery 4ed  
 by Robert L. Norton  
 McGraw-Hill  
 Copyright 2008

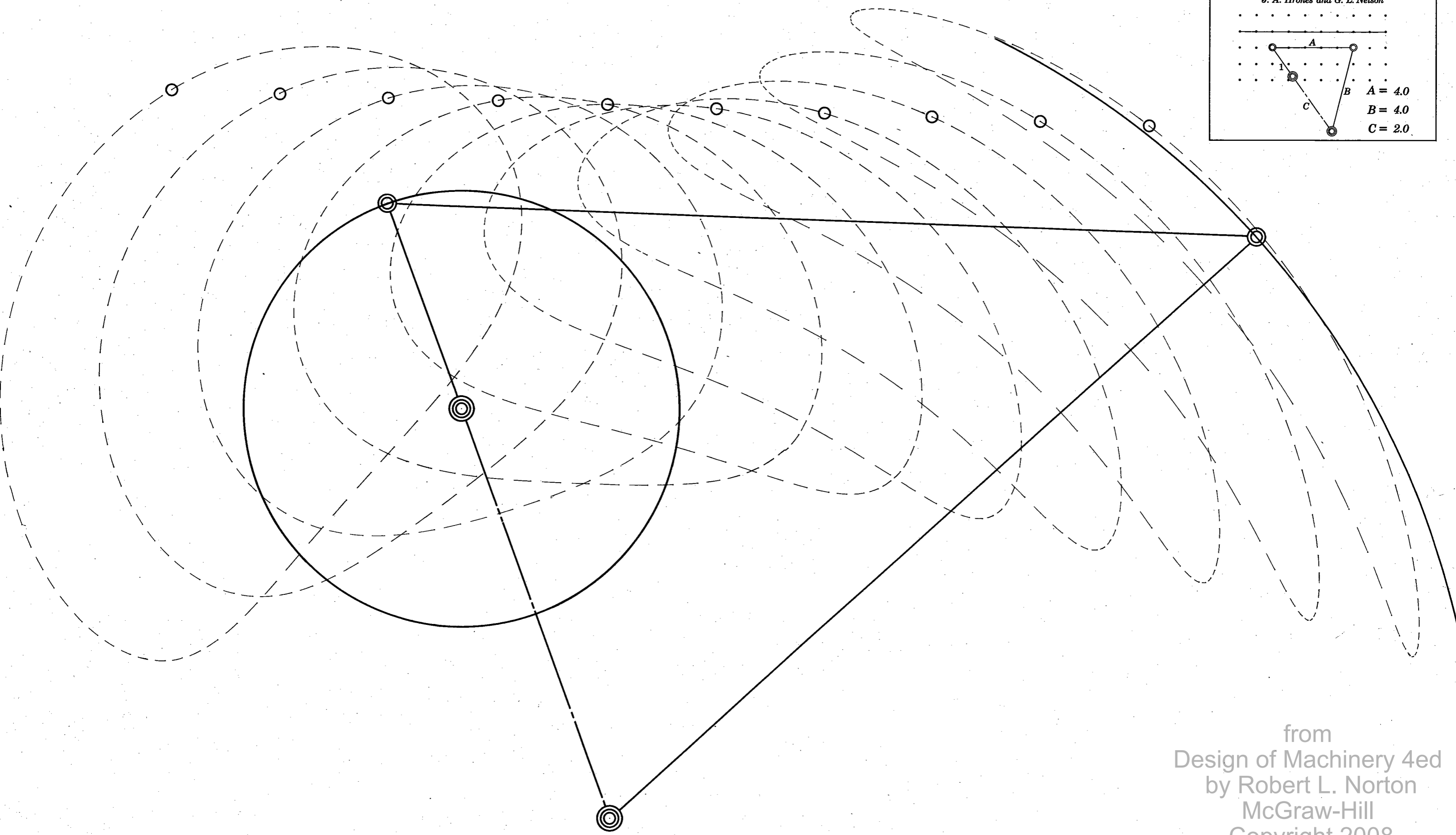
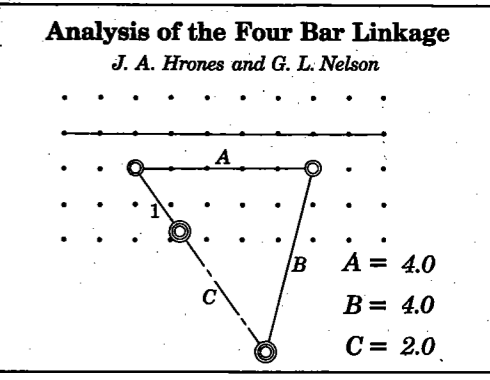

from  
Design of Machinery 4ed  
by Robert L. Norton  
McGraw-Hill  
Copyright 2008

**Analysis of the Four Bar Linkage**

*J. A. Hrones and G. L. Nelson*

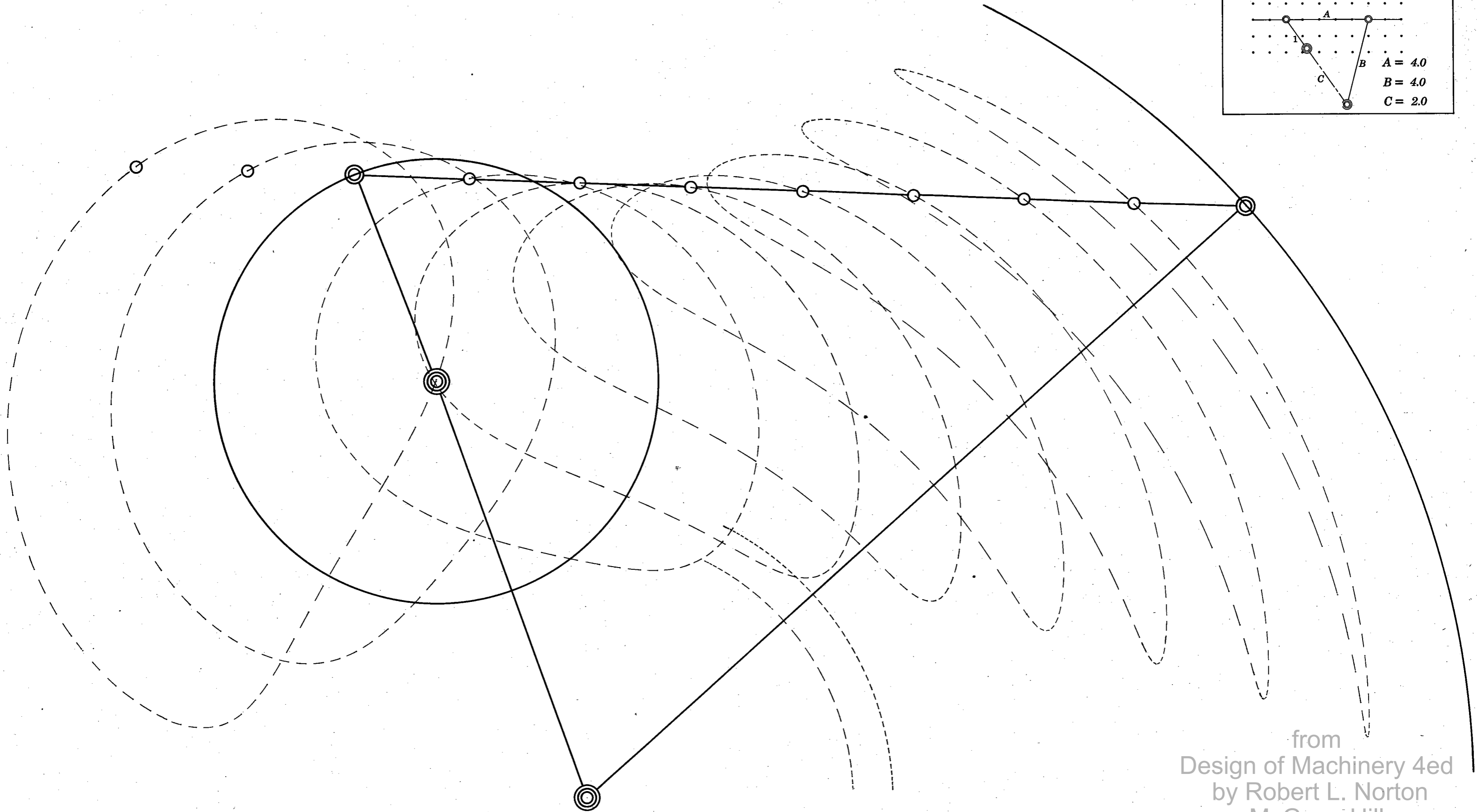
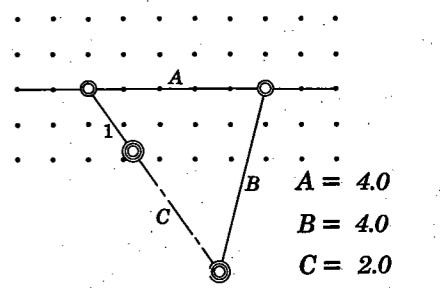

from  
Design of Machinery 4ed  
by Robert L. Norton  
McGraw-Hill  
Copyright 2008



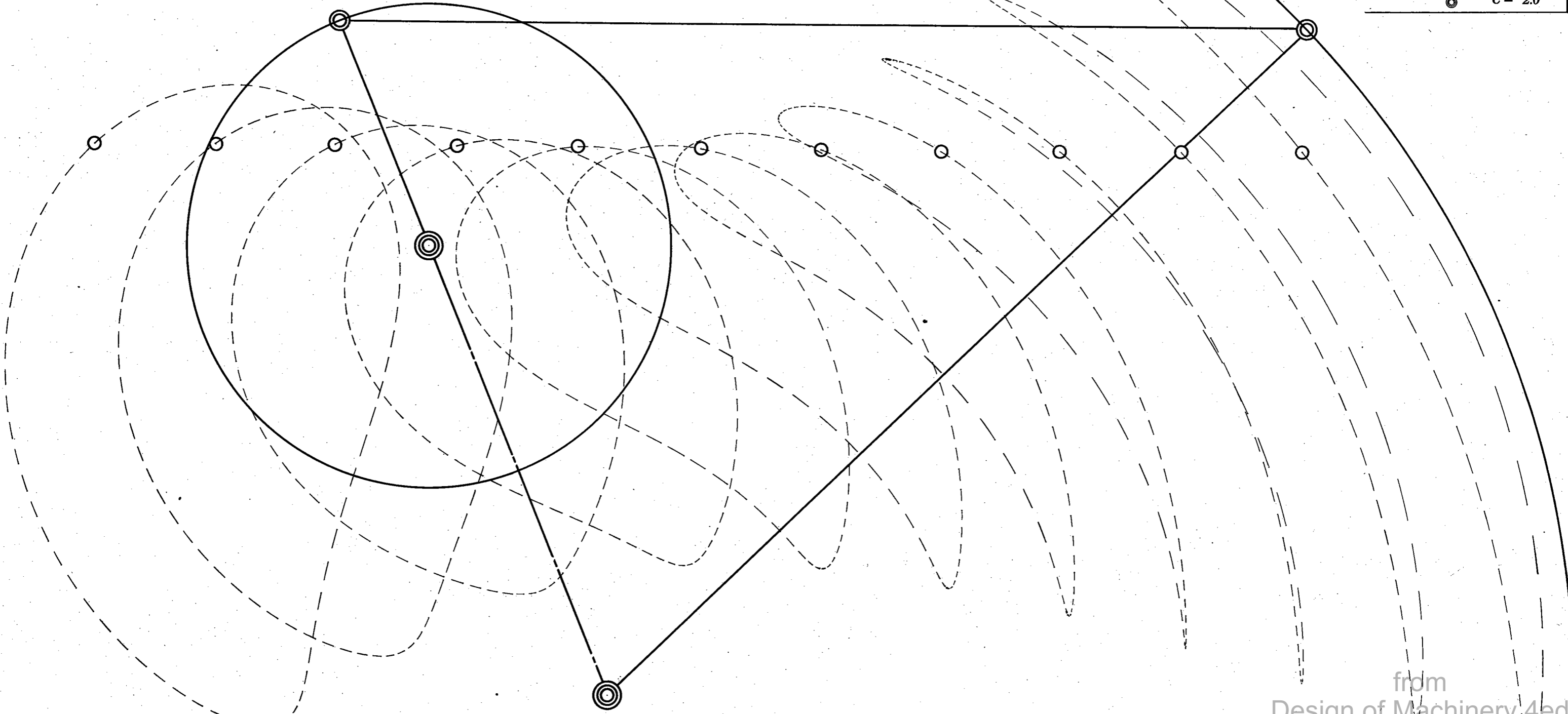
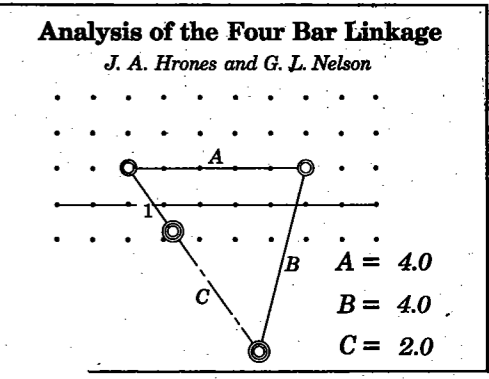

from  
Design of Machinery, 4ed  
by Robert L. Norton  
McGraw-Hill  
Copyright 2008

**Analysis of the Four Bar Linkage**

*J. A. Hrones and G. L. Nelson*

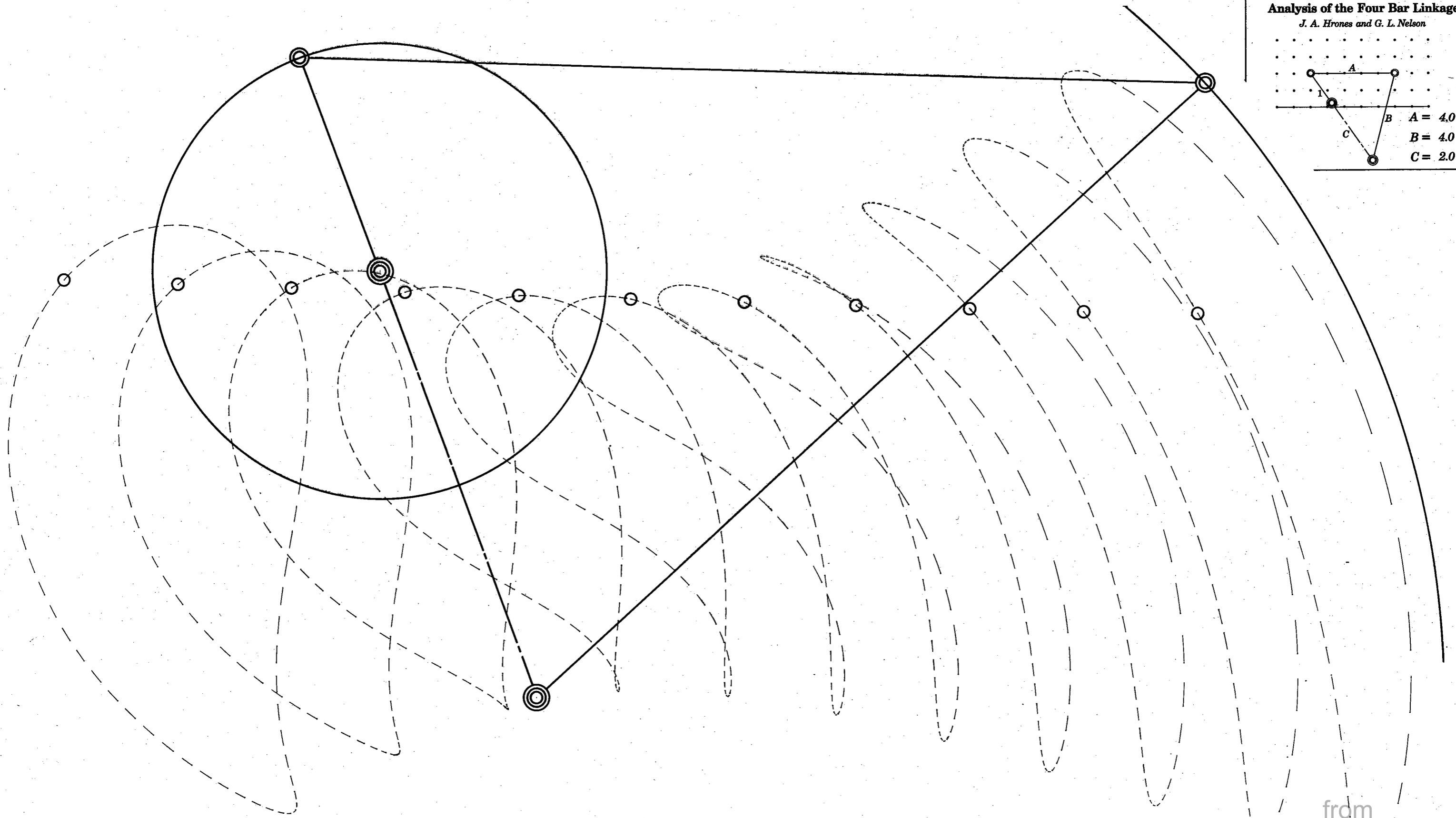
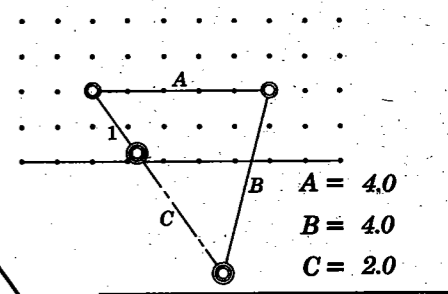

from  
Design of Machinery 4ed  
by Robert L. Norton  
McGraw-Hill  
Copyright 2008

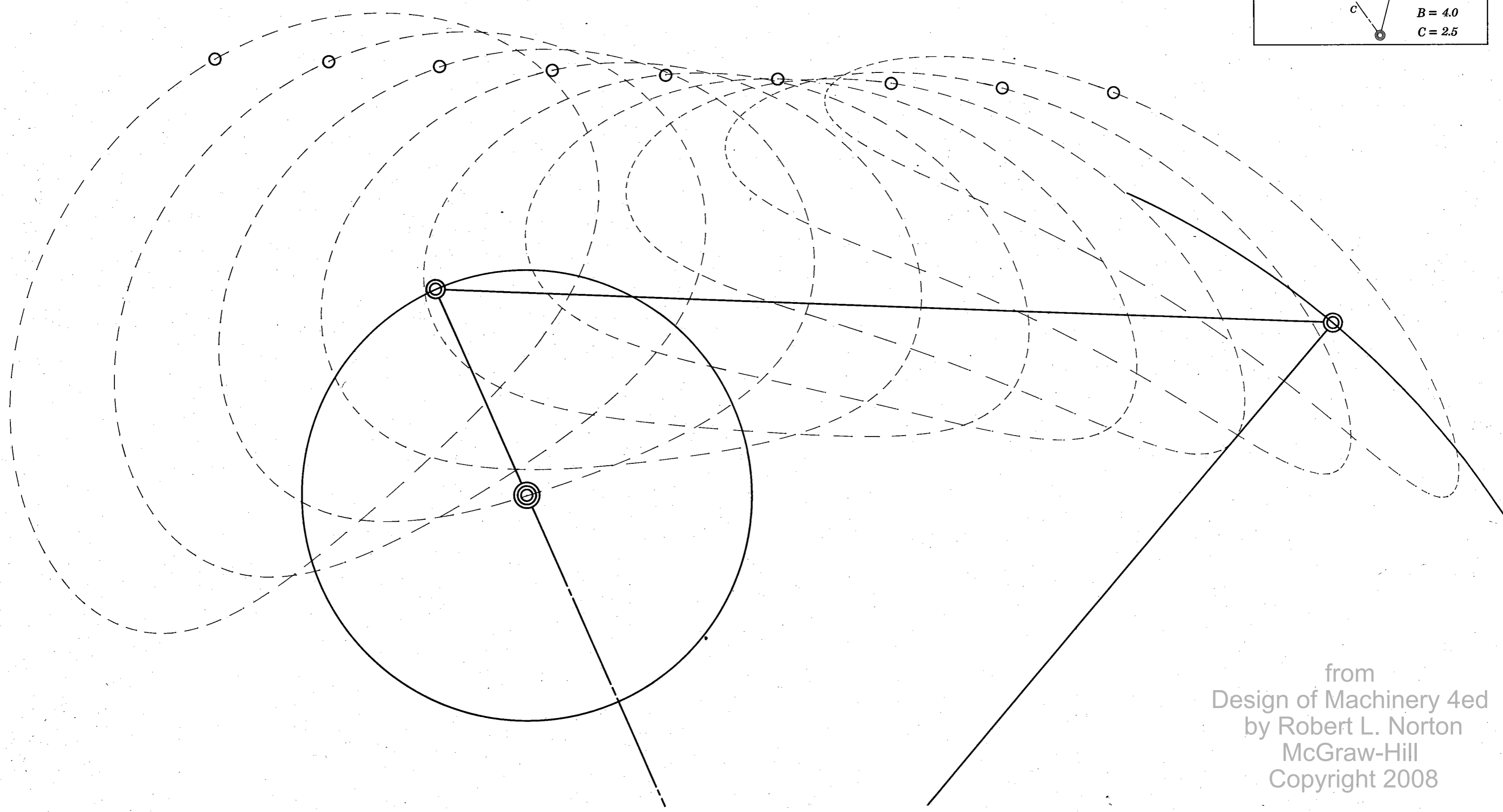
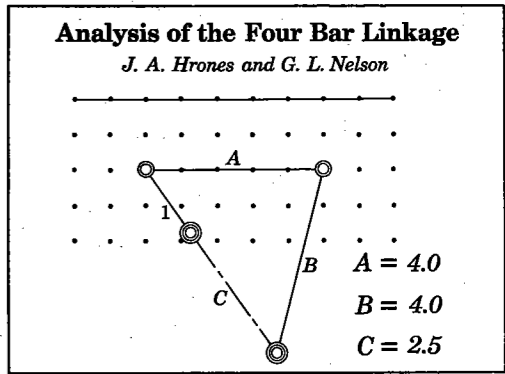

from  
Design of Machinery 4ed  
by Robert L. Norton  
McGraw-Hill  
Copyright 2008

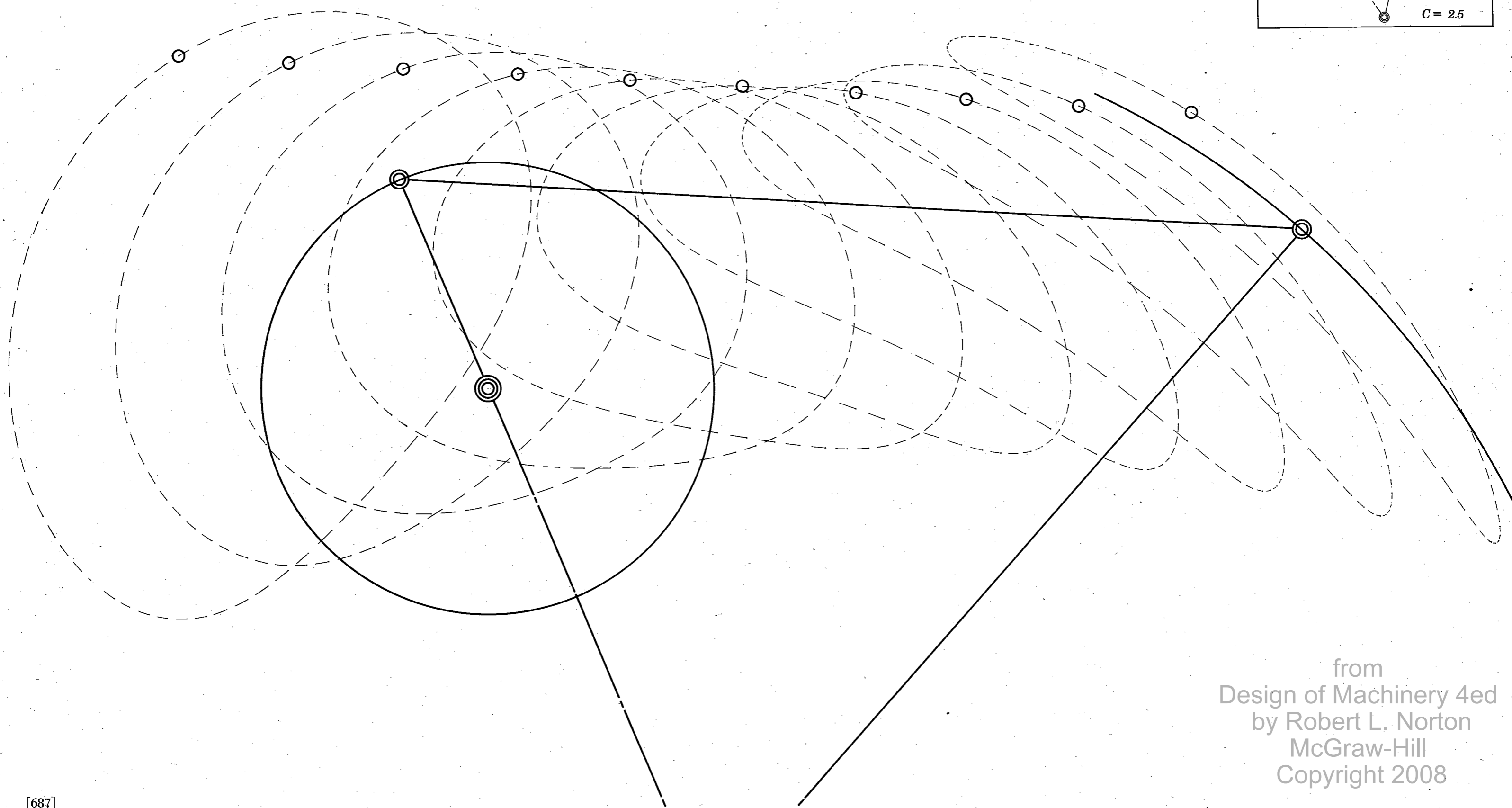
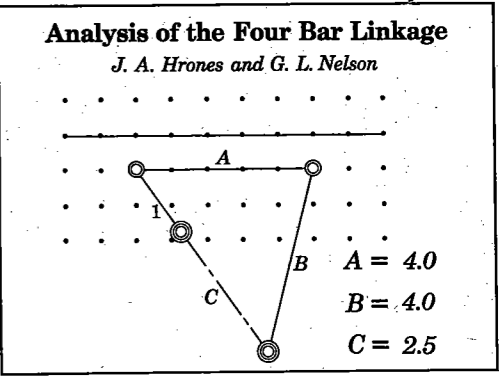

from  
 Design of Machinery 4ed  
 by Robert L. Norton  
 McGraw-Hill  
 Copyright 2008

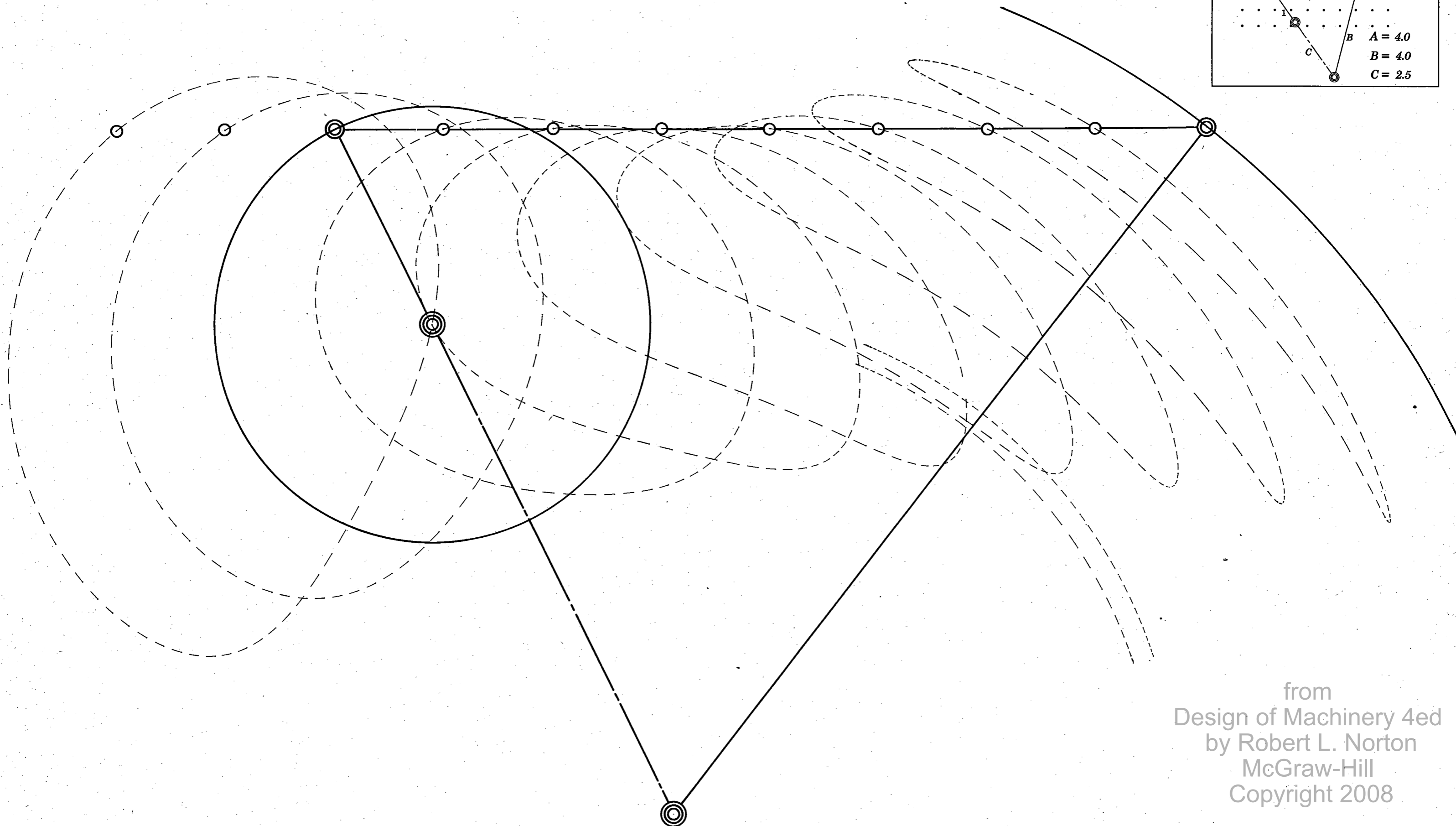
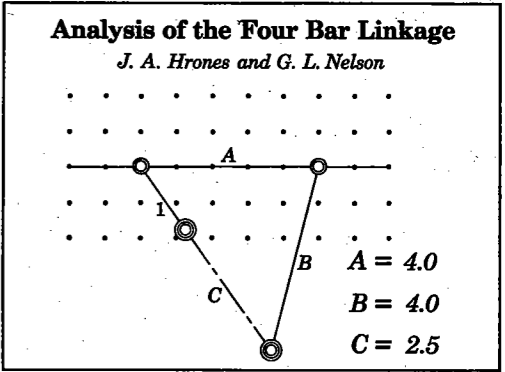

from  
Design of Machinery 4ed  
by Robert L. Norton  
McGraw-Hill  
Copyright 2008

**Analysis of the Four Bar Linkage**

*J. A. Hrones and G. L. Nelson*

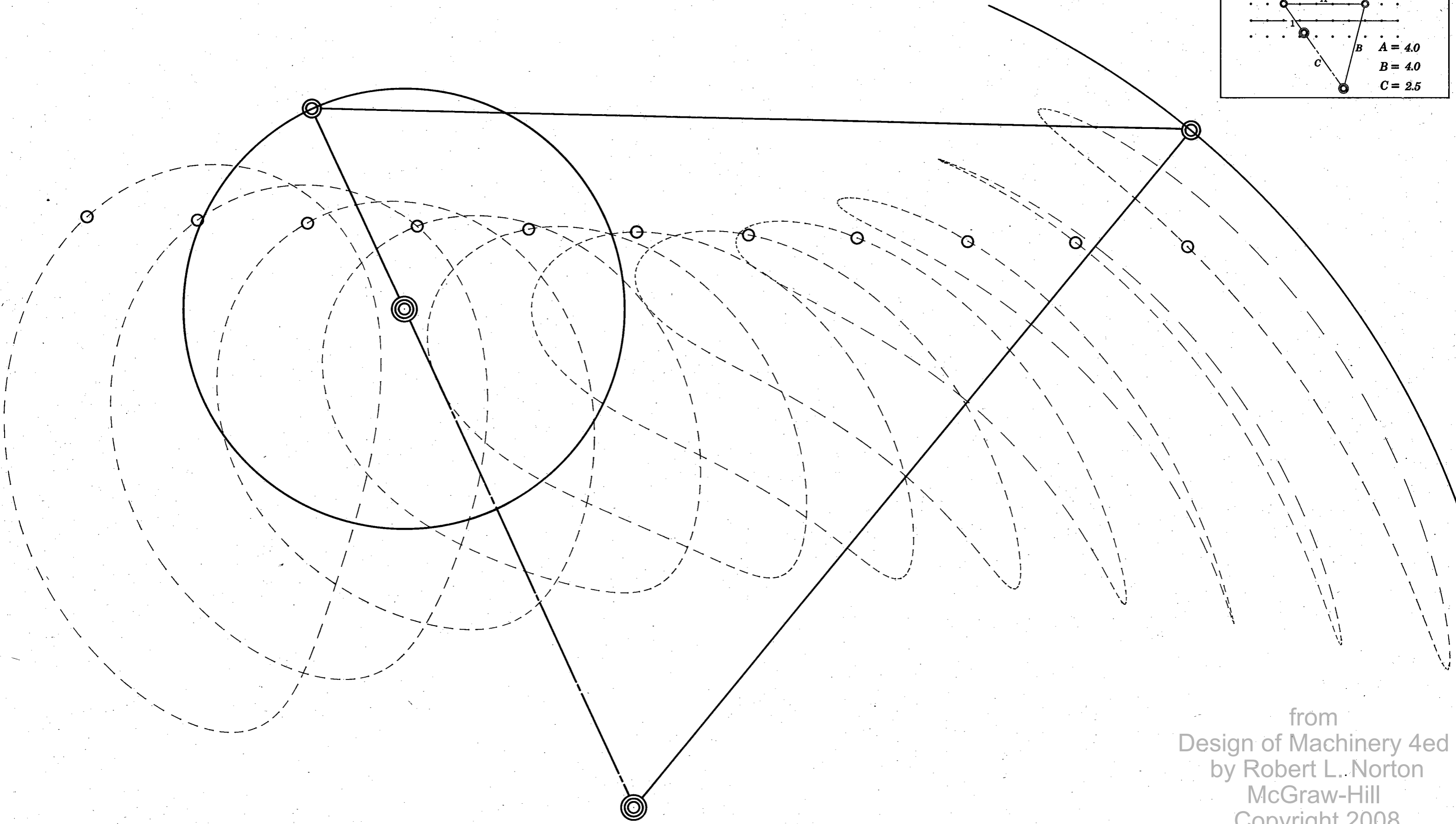
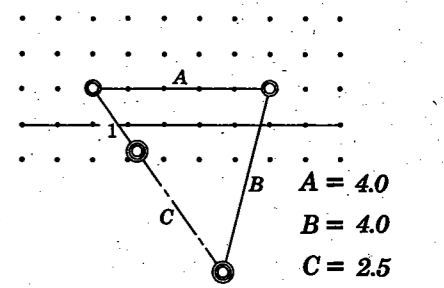

from  
Design of Machinery 4ed  
by Robert L. Norton  
McGraw-Hill  
Copyright 2008

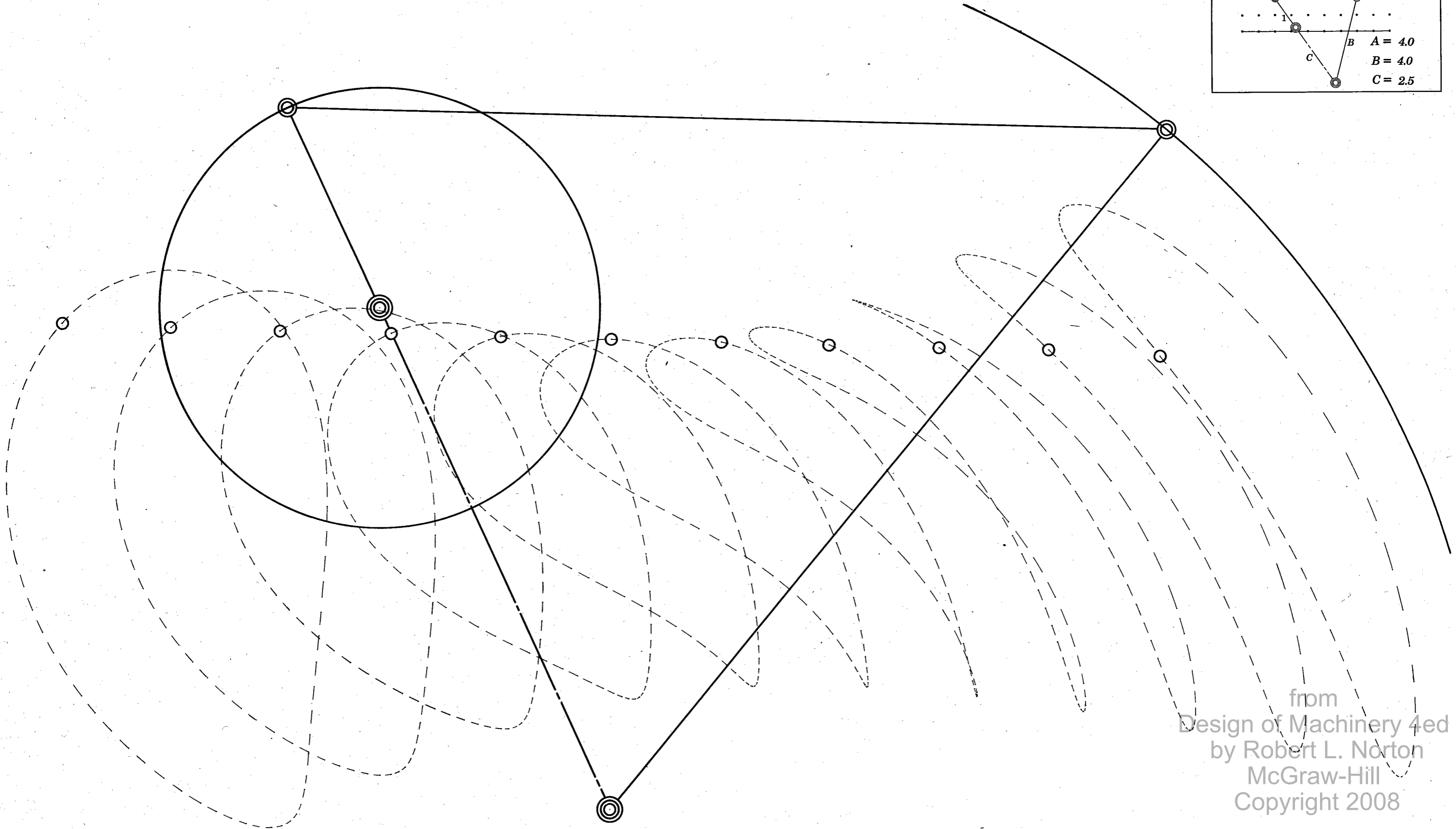
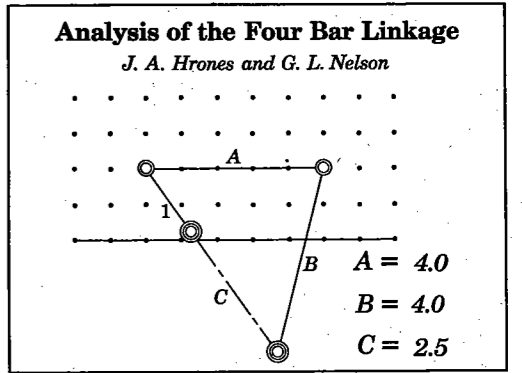

from  
Design of Machinery 4ed  
by Robert L. Norton  
McGraw-Hill  
Copyright 2008

**Analysis of the Four Bar Linkage**

*J. A. Hrones and G. L. Nelson*

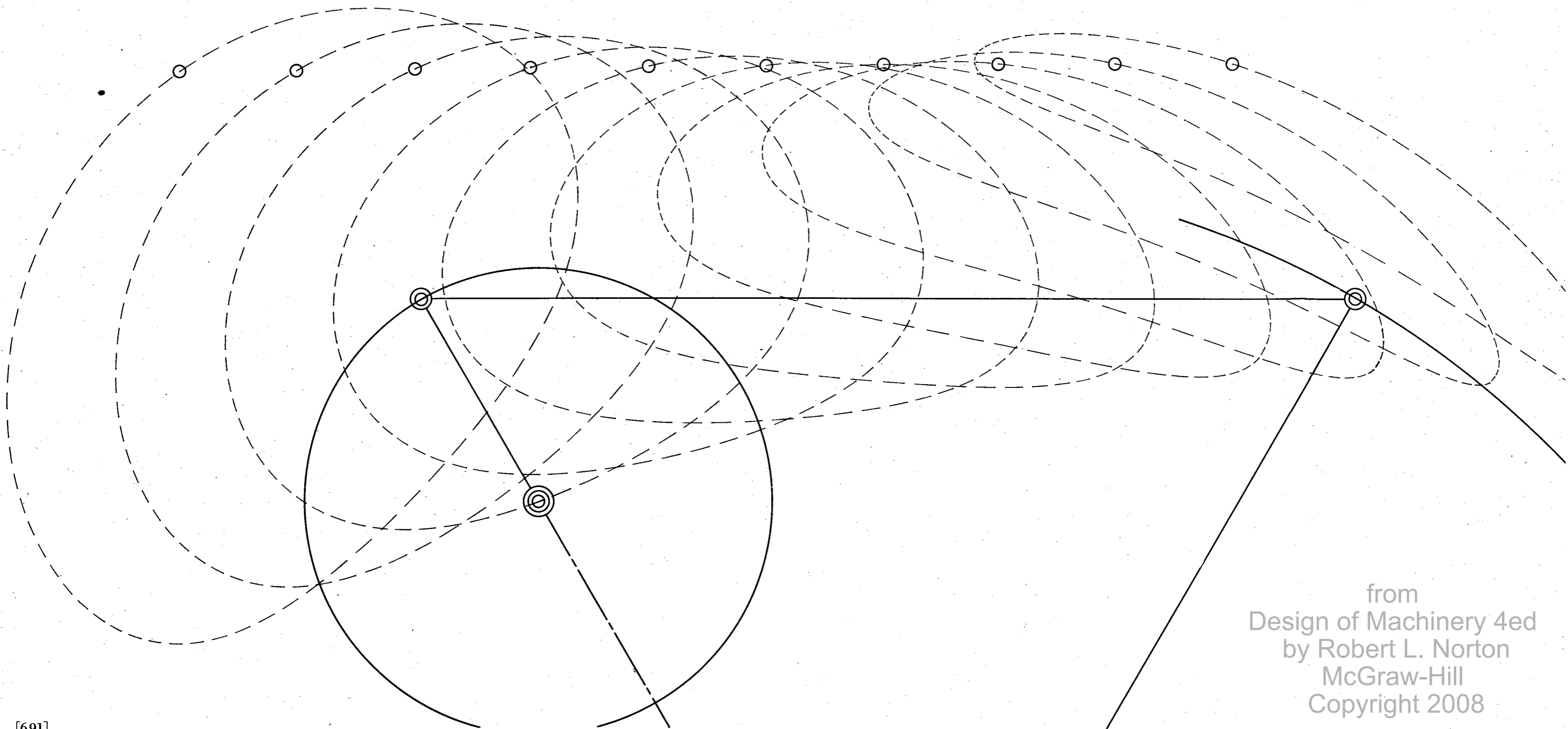
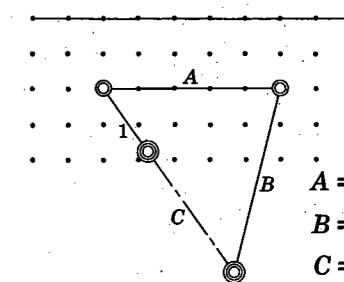

from  
Design of Machinery 4ed  
by Robert L. Norton  
McGraw-Hill  
Copyright 2008



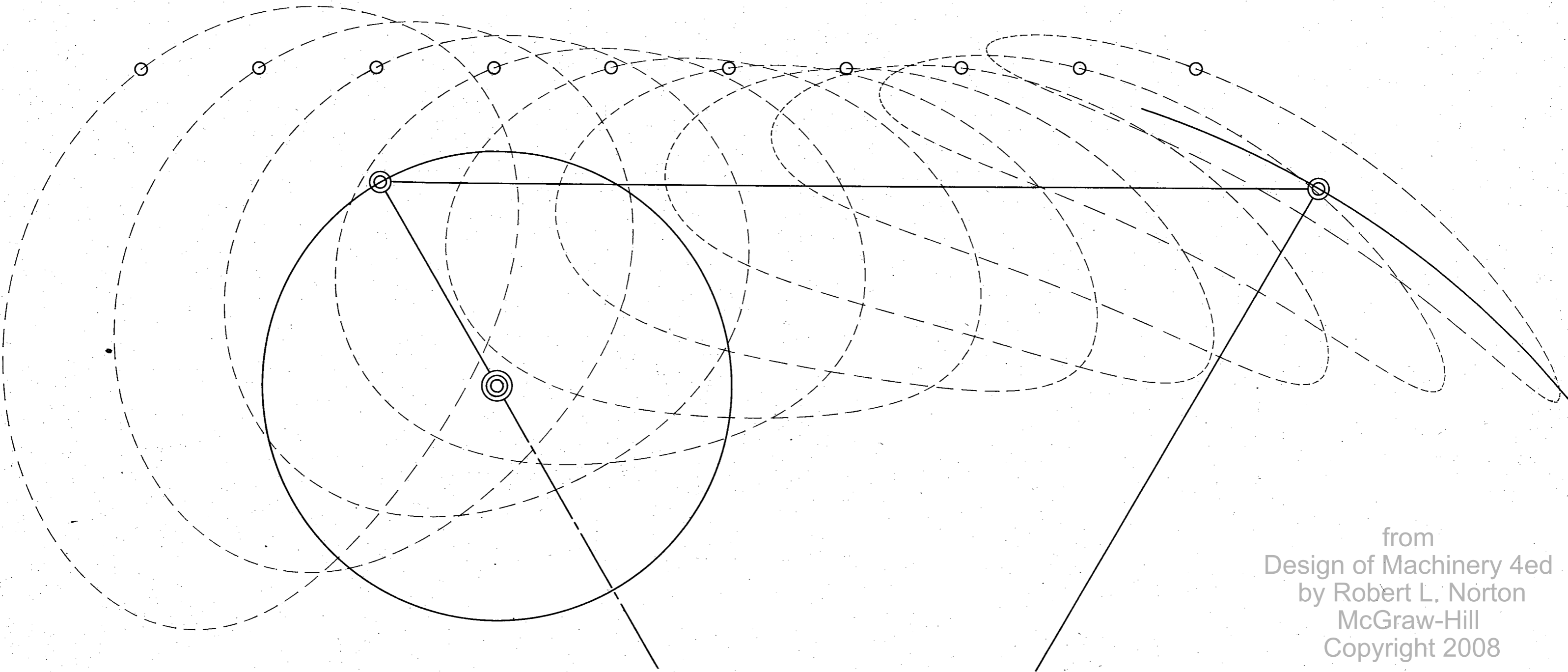
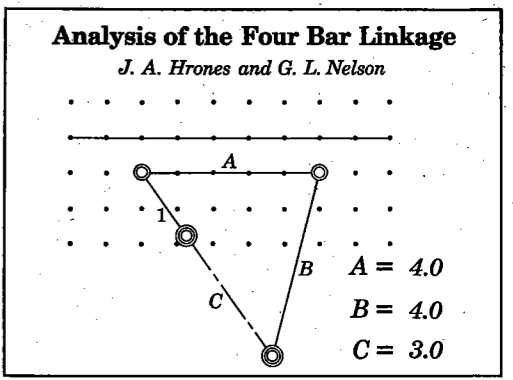

from  
Design of Machinery 4ed  
by Robert L. Norton  
McGraw-Hill  
Copyright 2008

**Analysis of the Four Bar Linkage**  
*J. A. Hrones and G. L. Nelson*

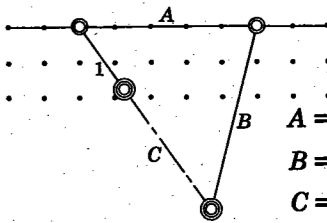

$A = 4.0$   
 $B = 4.0$   
 $C = 3.0$

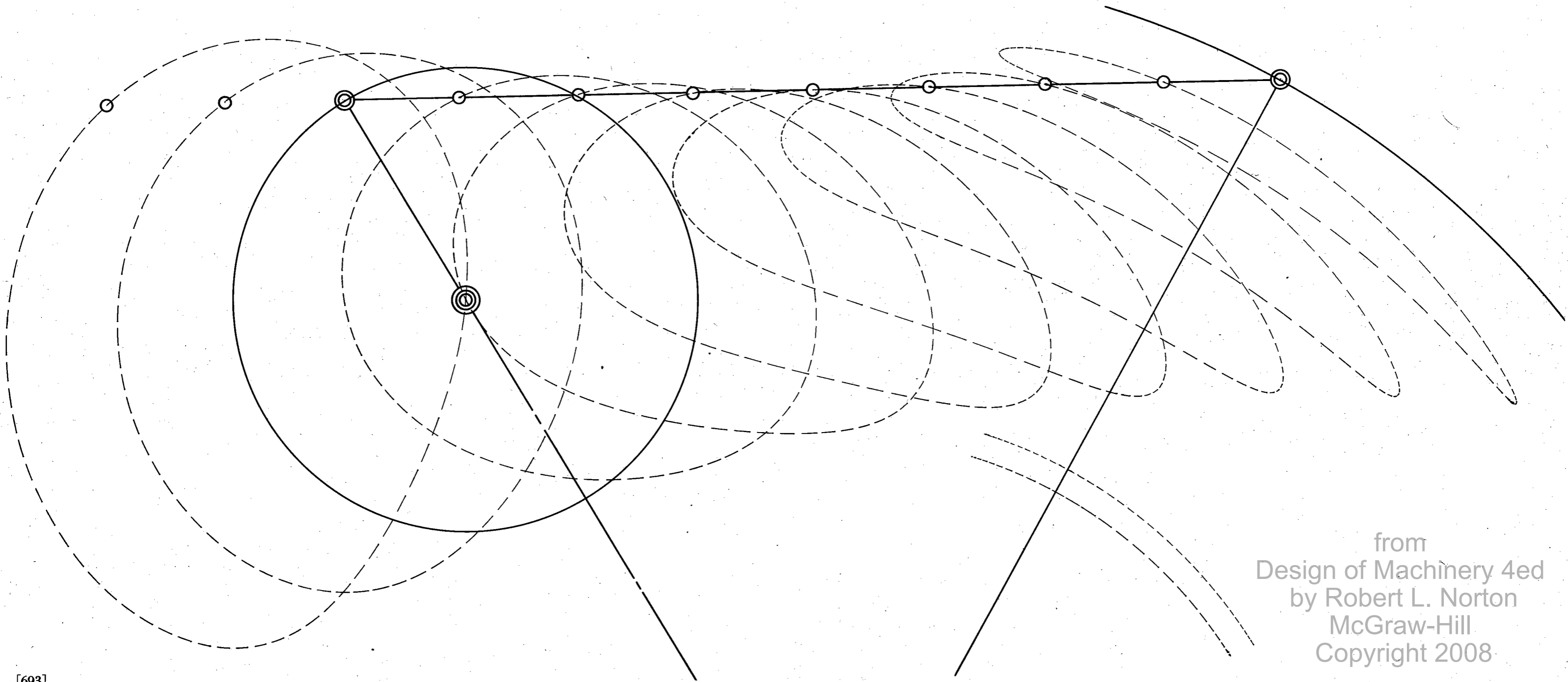

from  
 Design of Machinery 4ed  
 by Robert L. Norton  
 McGraw-Hill  
 Copyright 2008

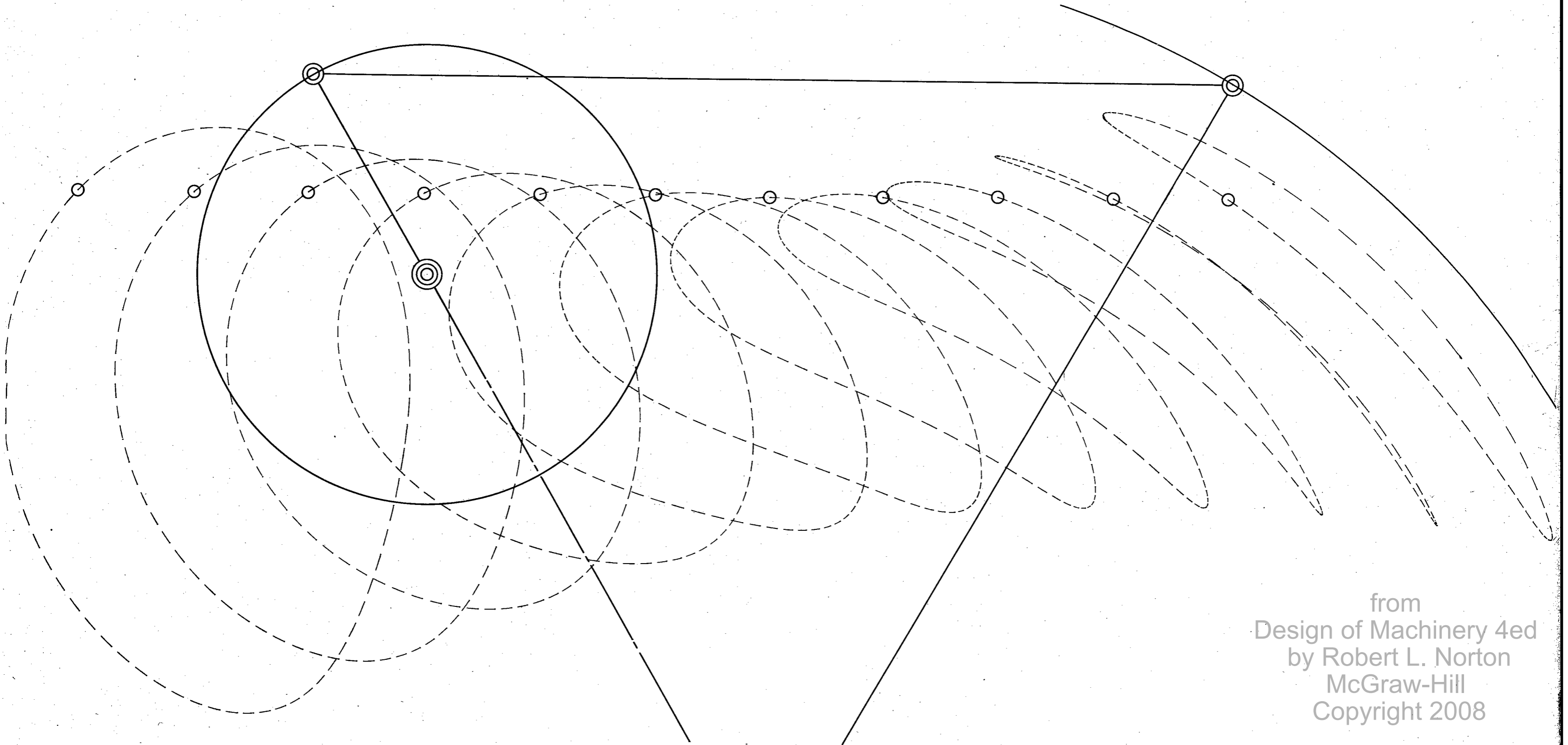
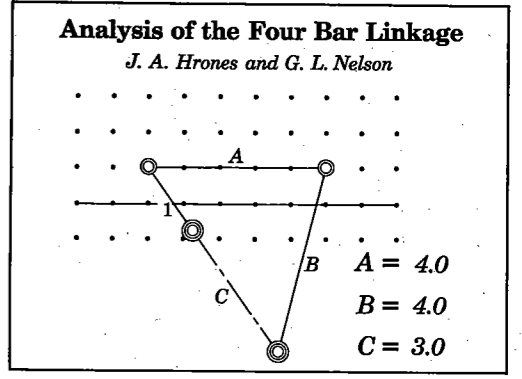

from  
Design of Machinery 4ed  
by Robert L. Norton  
McGraw-Hill  
Copyright 2008

**Analysis of the Four Bar Linkage**

*J. A. Hrones and G. L. Nelson*

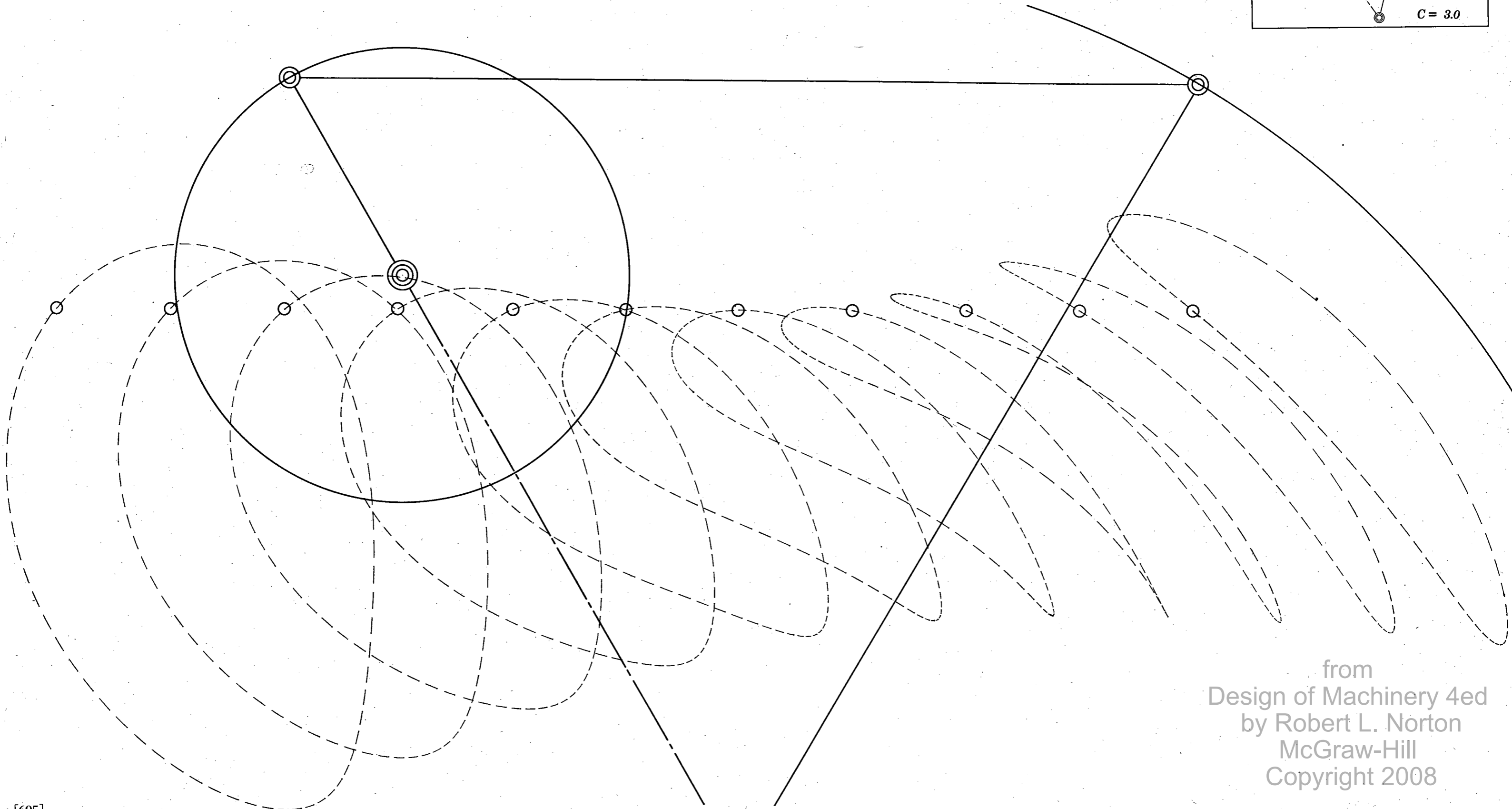
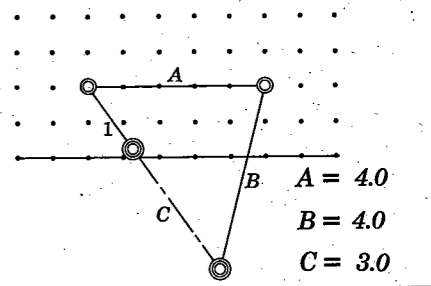

from  
Design of Machinery 4ed  
by Robert L. Norton  
McGraw-Hill  
Copyright 2008

**Analysis of the Four Bar Linkage**

*J. A. Hrones and G. L. Nelson*

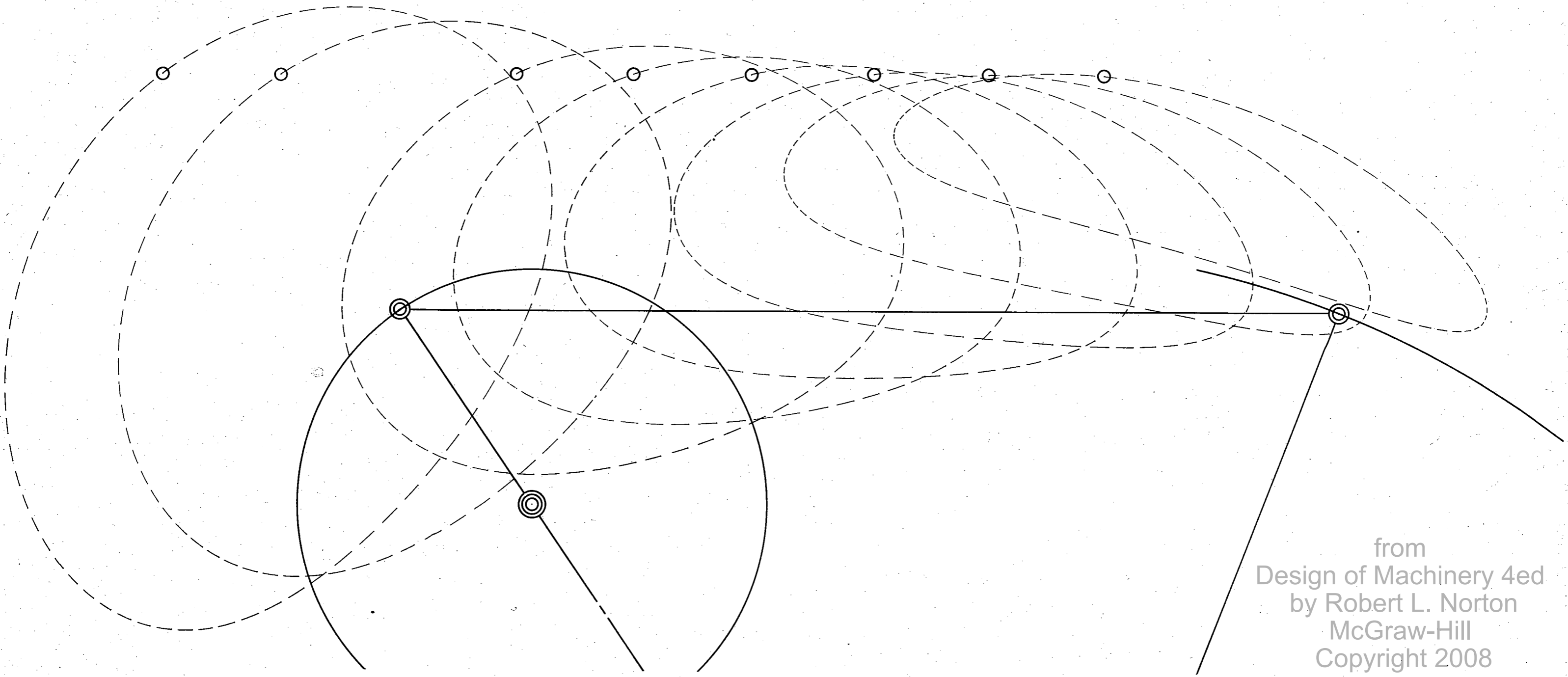
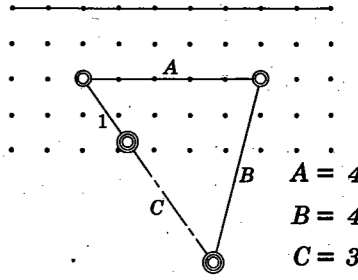

from  
Design of Machinery 4ed  
by Robert L. Norton  
McGraw-Hill  
Copyright 2008

**Analysis of the Four Bar Linkage**

*J. A. Hrones and G. L. Nelson*

.....

.....

.....

.....

.....

.....

.....

.....

.....

.....

.....

.....

.....

.....

.....

.....

.....

.....

.....

.....

.....

.....

.....

.....

.....

.....

.....

.....

.....

.....

.....

.....

.....

.....

.....

.....

.....

.....

.....

.....

.....

.....

.....

.....

.....

.....

.....

A

B

C

A = 4.0

B = 4.0

C = 3.5

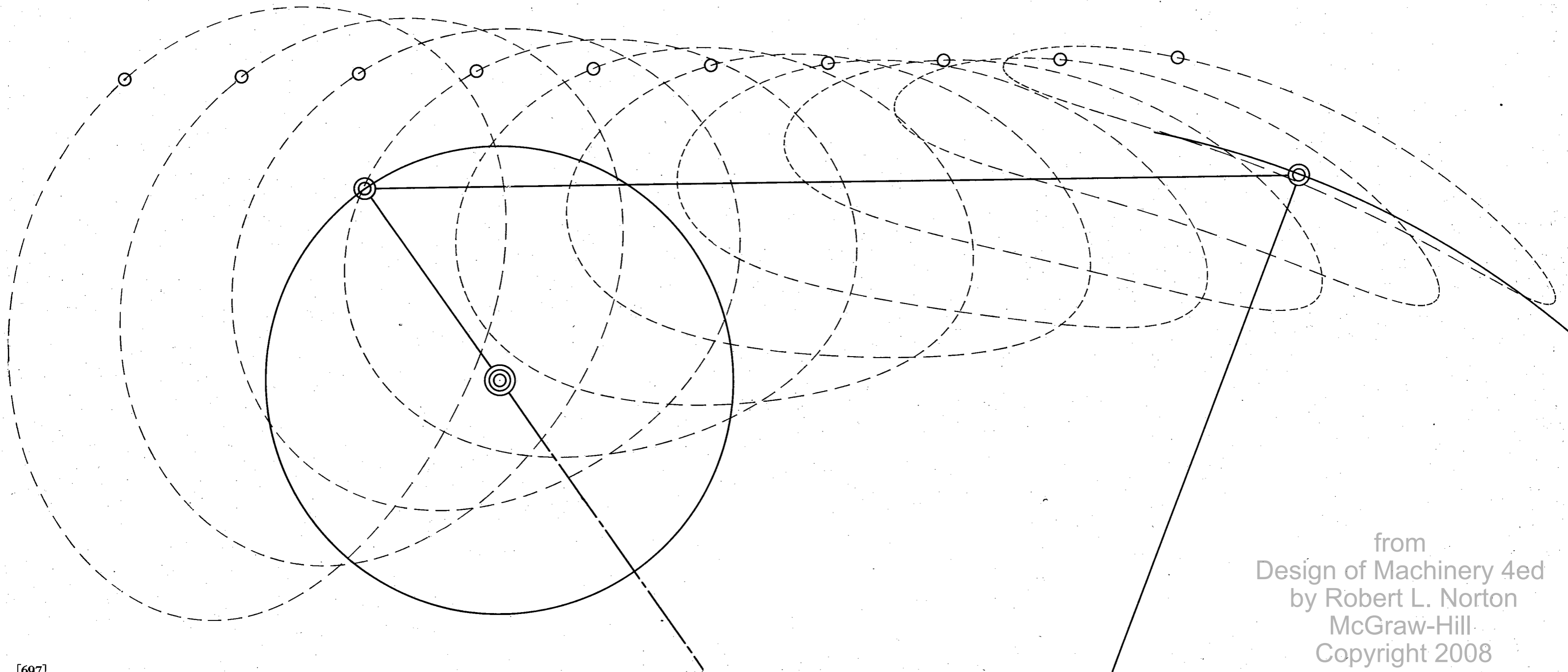

from  
Design of Machinery 4ed  
by Robert L. Norton  
McGraw-Hill  
Copyright 2008

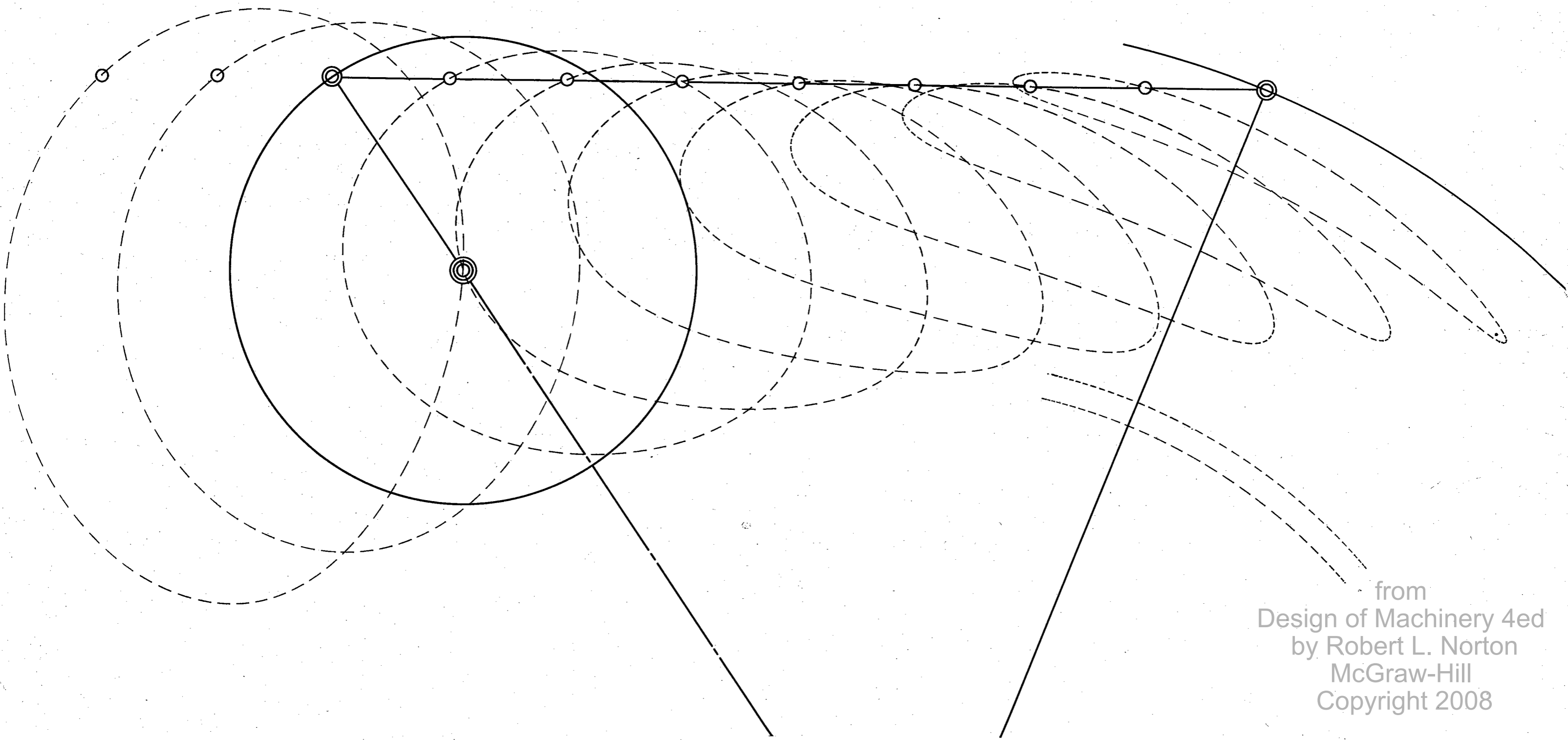
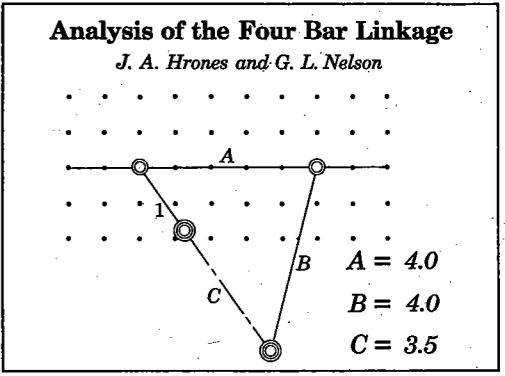

from  
Design of Machinery 4ed  
by Robert L. Norton  
McGraw-Hill  
Copyright 2008

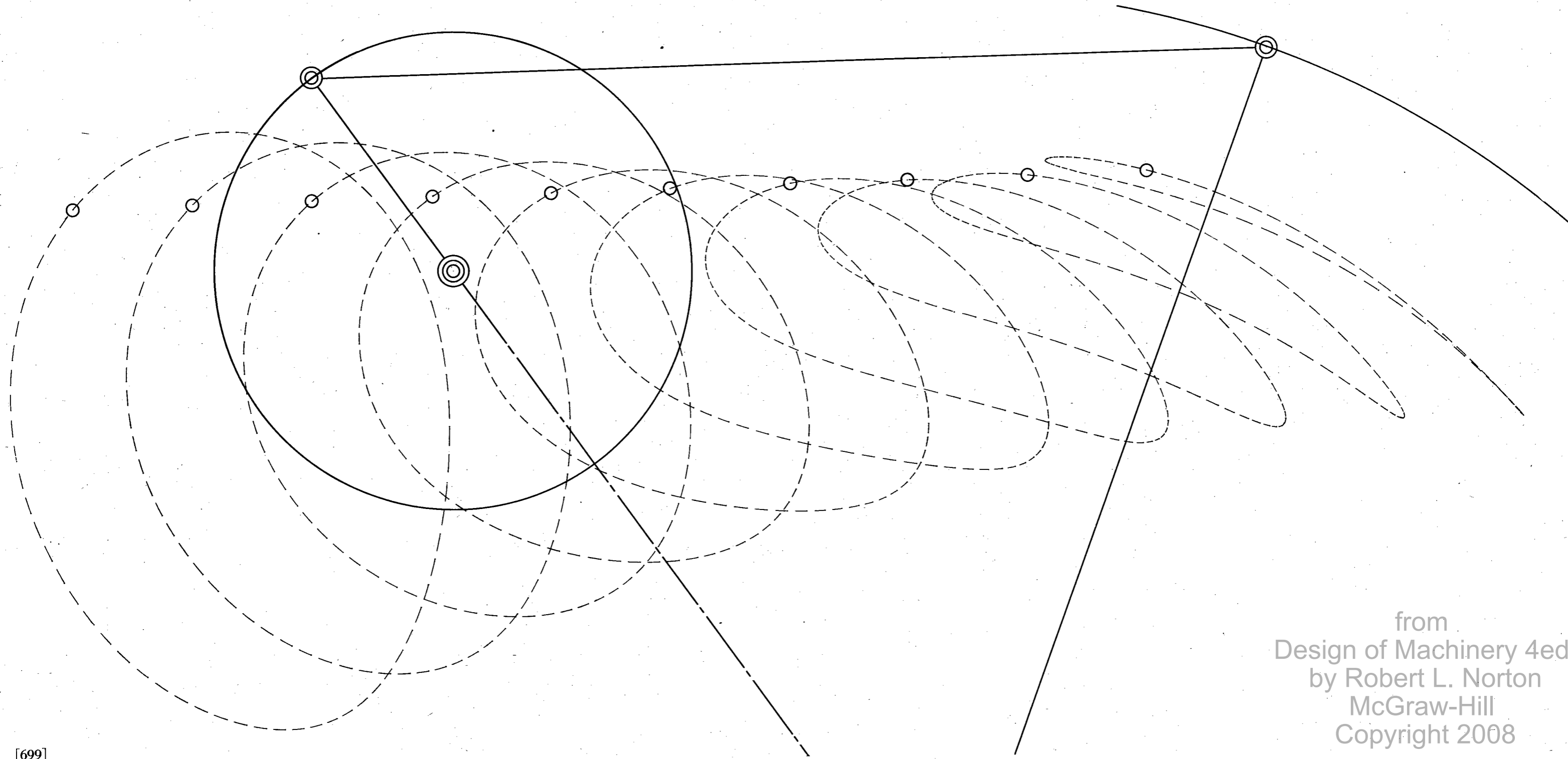
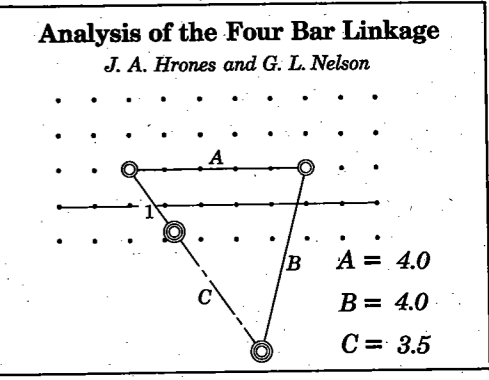

from  
 Design of Machinery 4ed  
 by Robert L. Norton  
 McGraw-Hill  
 Copyright 2008



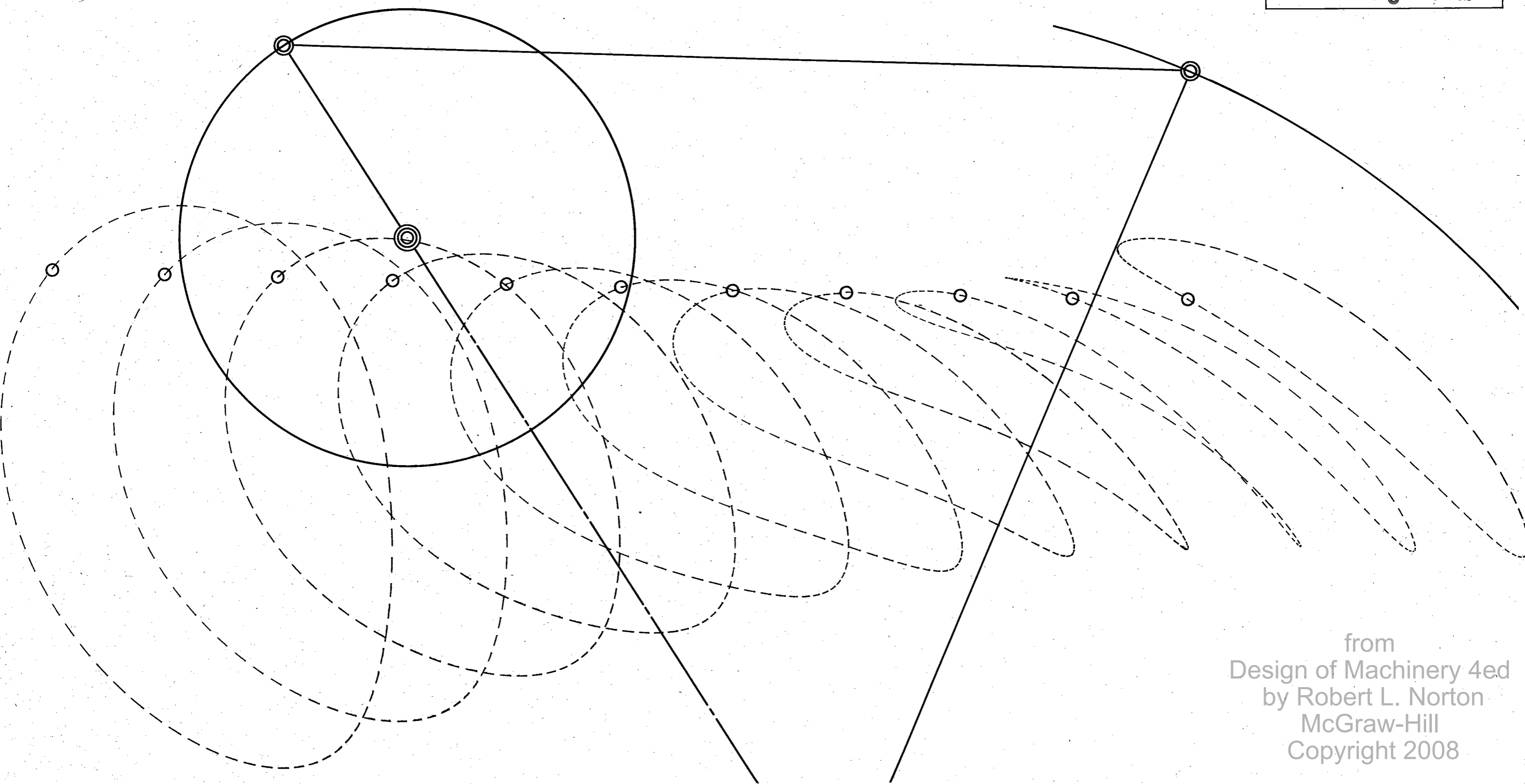
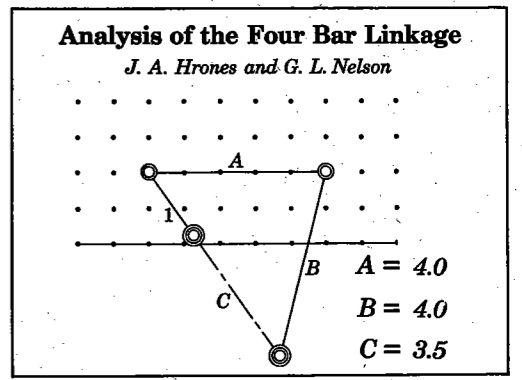

from  
Design of Machinery 4ed  
by Robert L. Norton  
McGraw-Hill  
Copyright 2008

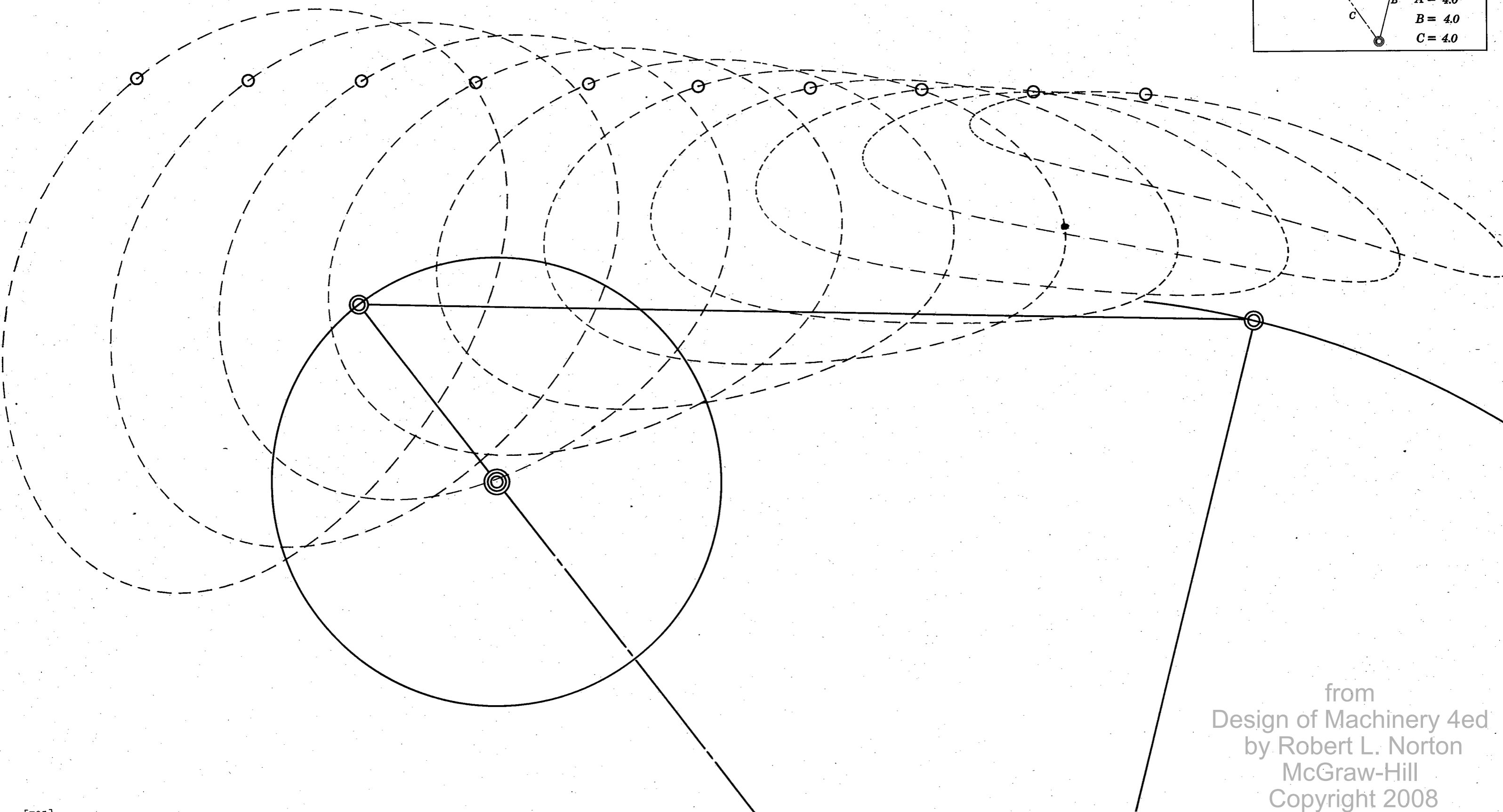
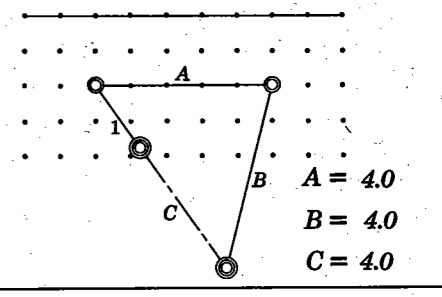

from  
Design of Machinery 4ed  
by Robert L. Norton  
McGraw-Hill  
Copyright 2008

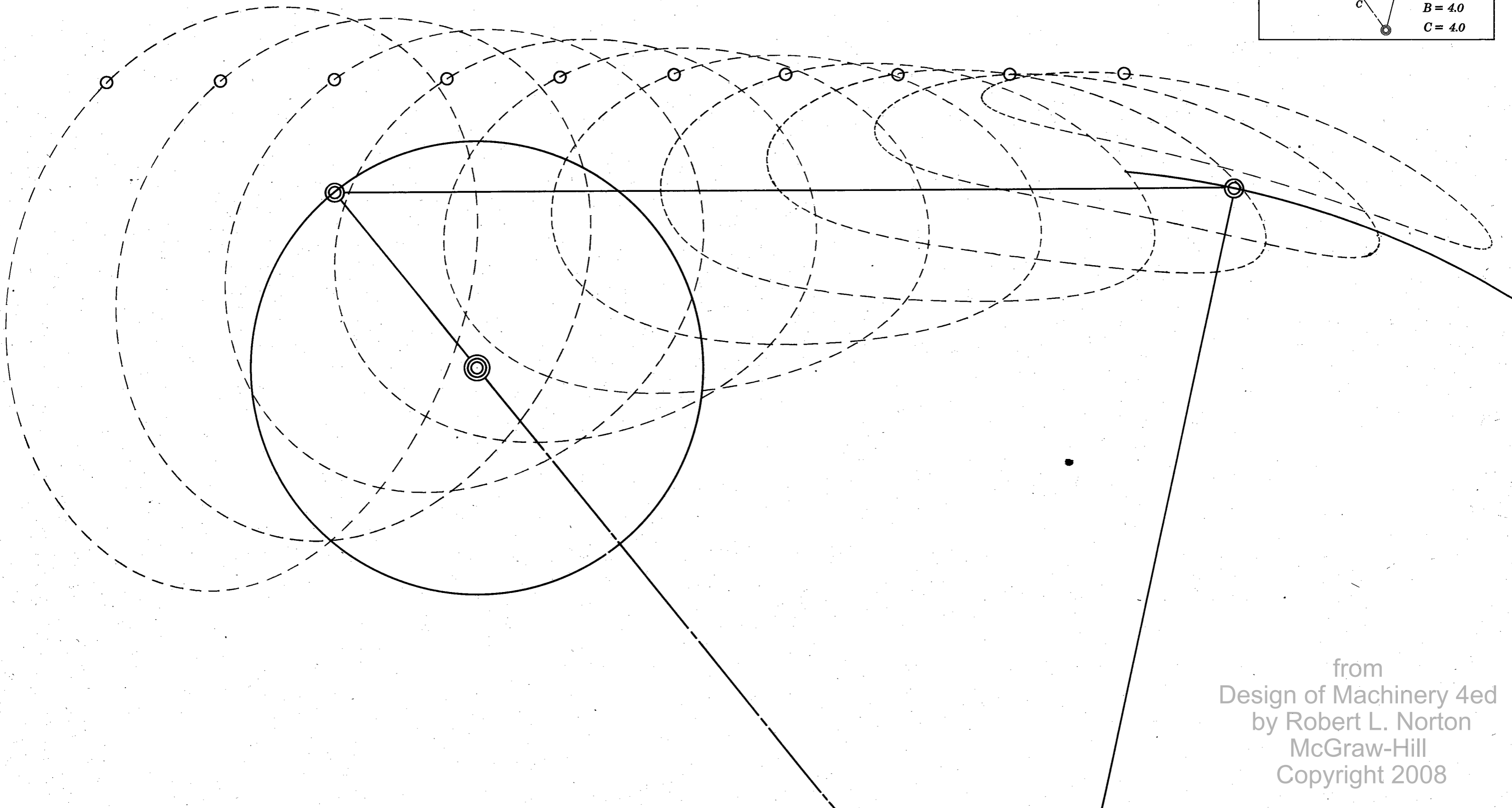
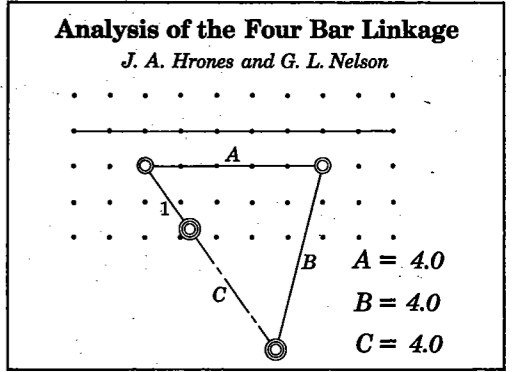

from  
Design of Machinery 4ed  
by Robert L. Norton  
McGraw-Hill  
Copyright 2008

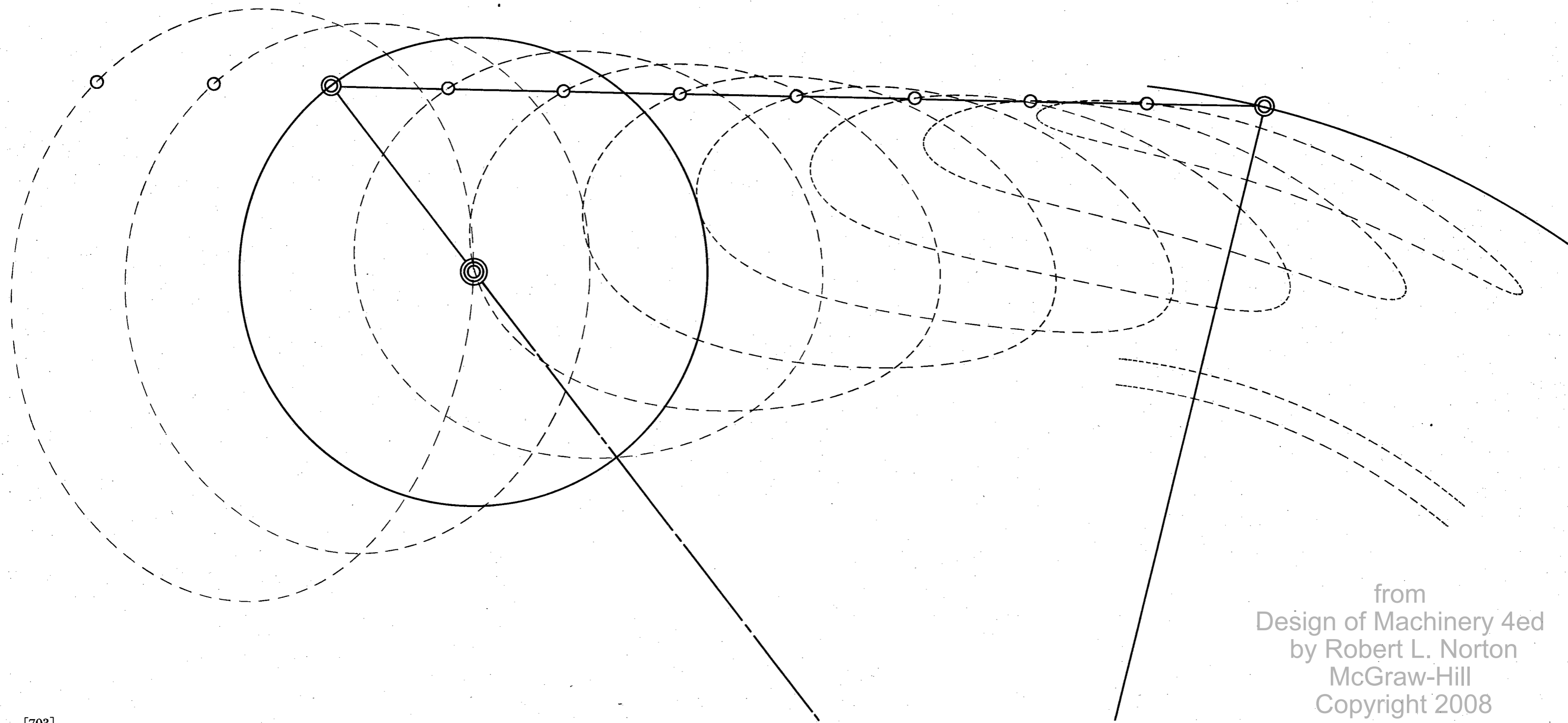
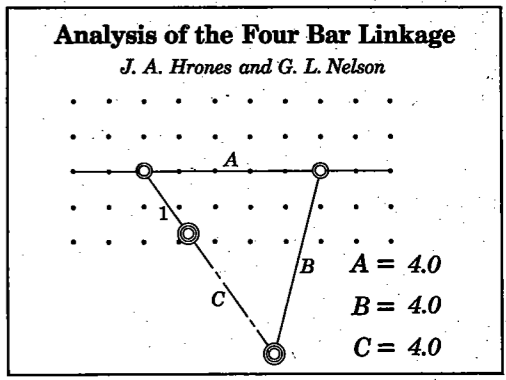

from  
 Design of Machinery 4ed  
 by Robert L. Norton  
 McGraw-Hill  
 Copyright 2008

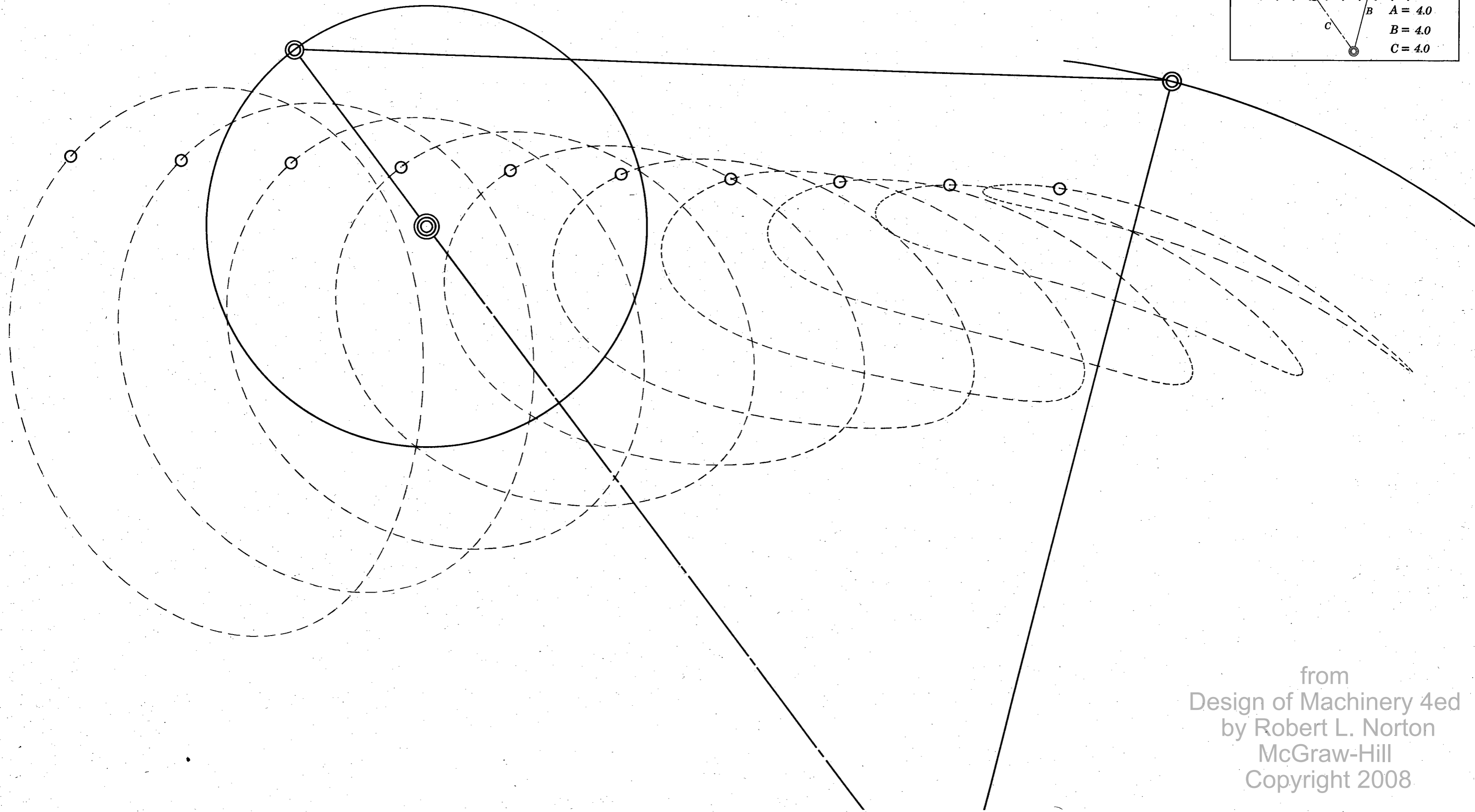
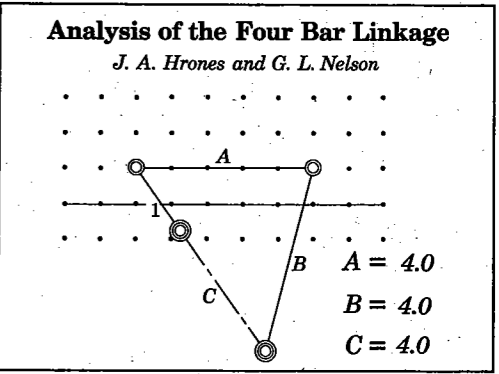

from  
Design of Machinery 4ed  
by Robert L. Norton  
McGraw-Hill  
Copyright 2008

**Analysis of the Four Bar Linkage**

*J. A. Hrones and G. L. Nelson*

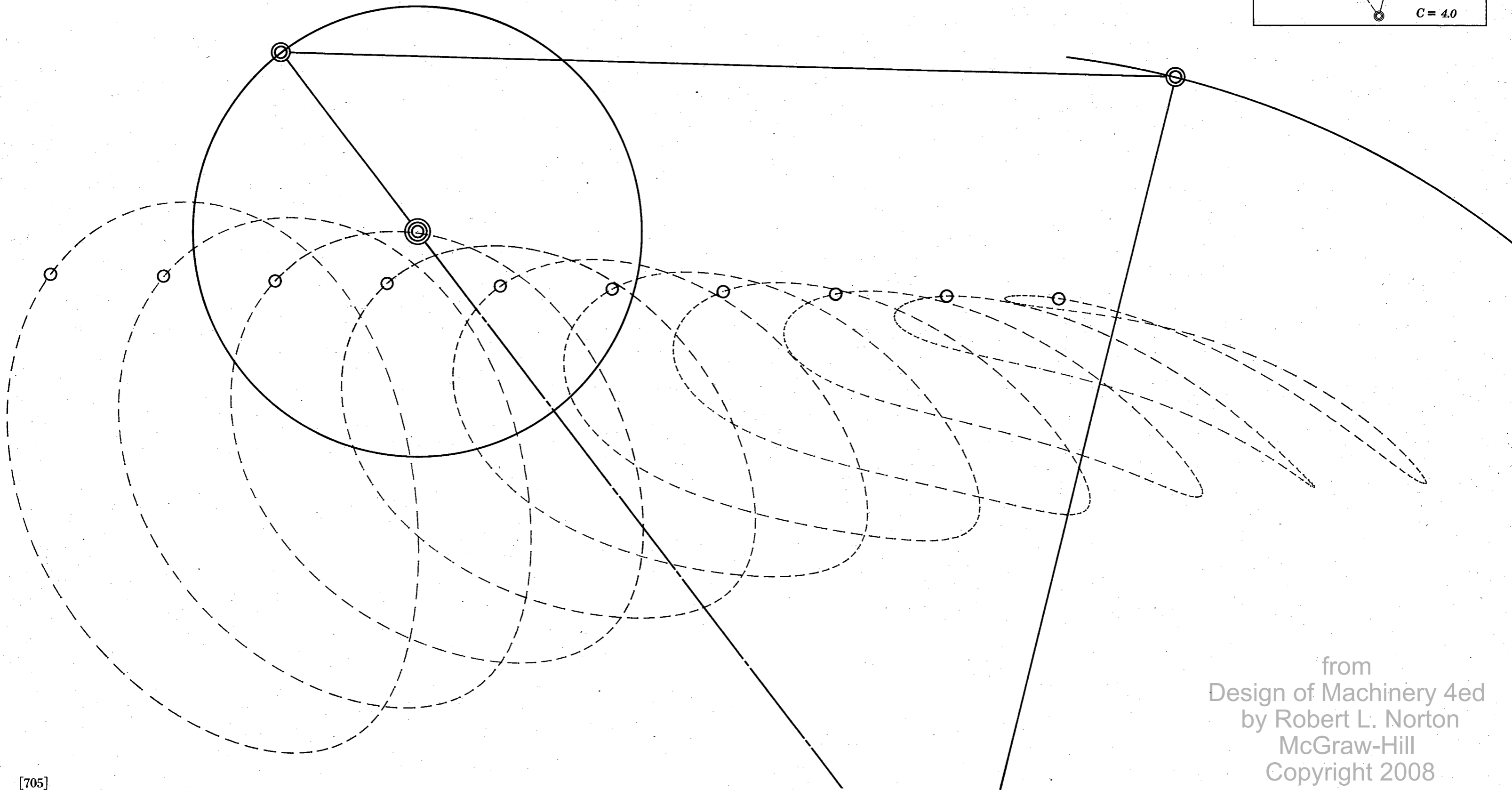
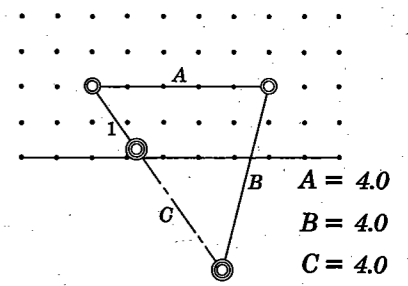

from  
Design of Machinery 4ed  
by Robert L. Norton  
McGraw-Hill  
Copyright 2008

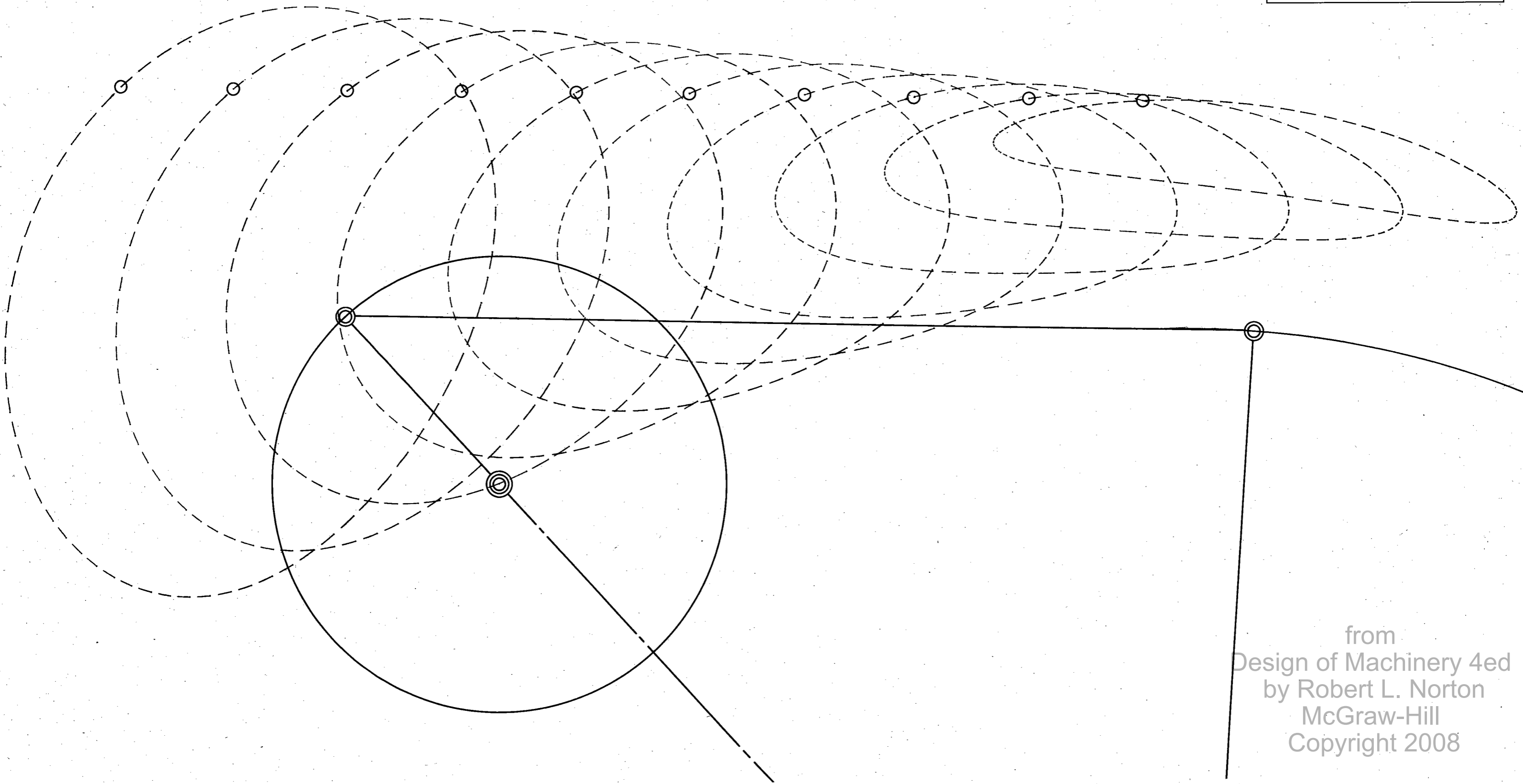
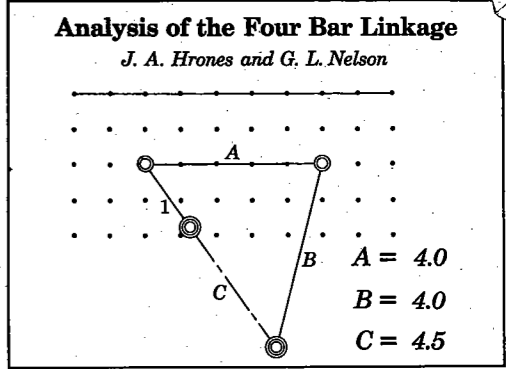

from  
Design of Machinery 4ed  
by Robert L. Norton  
McGraw-Hill  
Copyright 2008

**Analysis of the Four Bar Linkage**

*J. A. Hrones and G. L. Nelson*

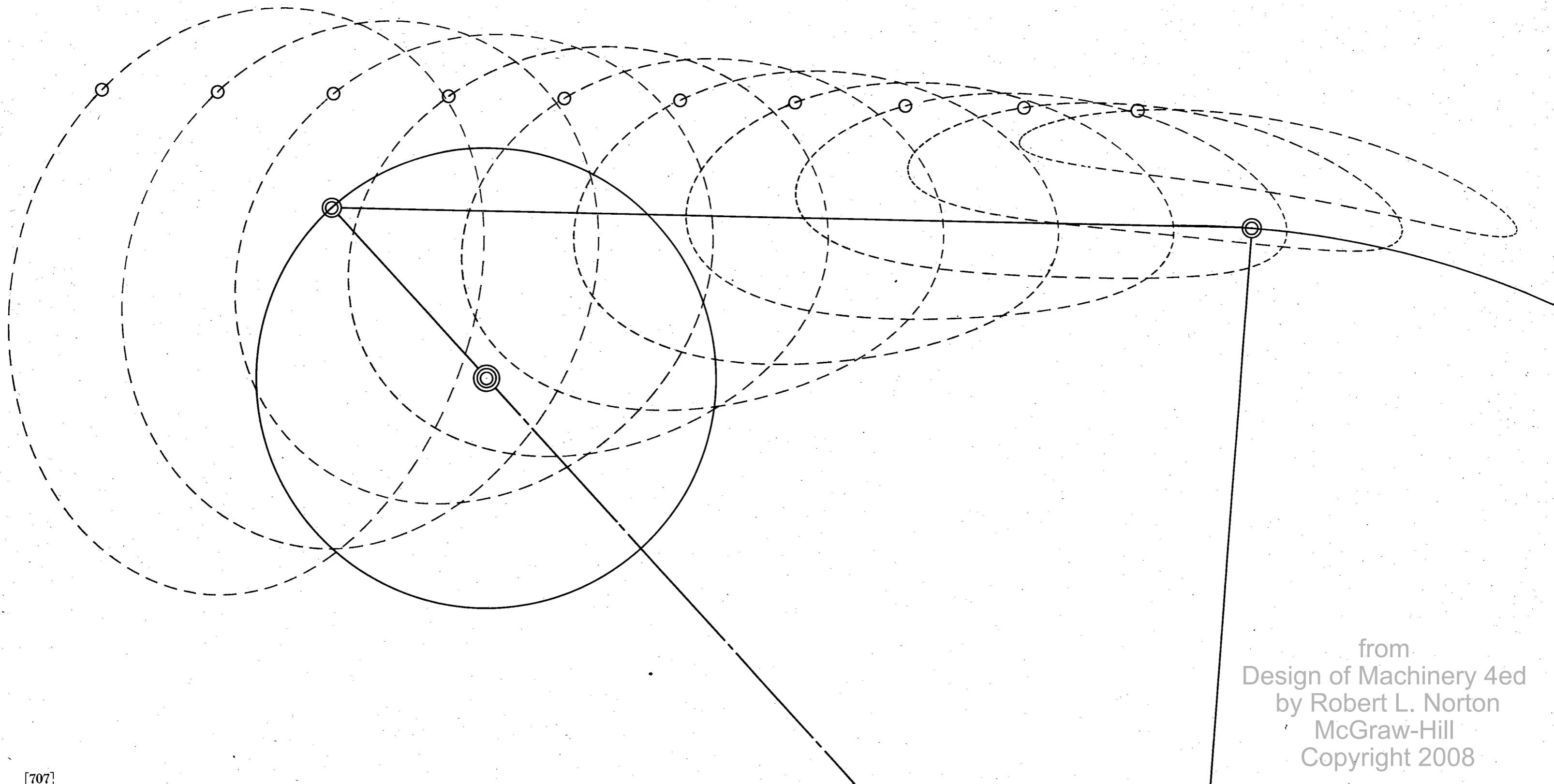
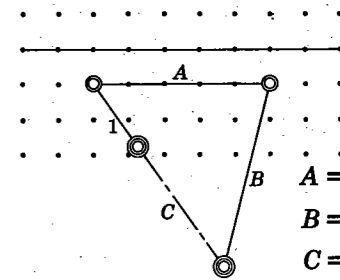

from  
Design of Machinery 4ed  
by Robert L. Norton  
McGraw-Hill  
Copyright 2008



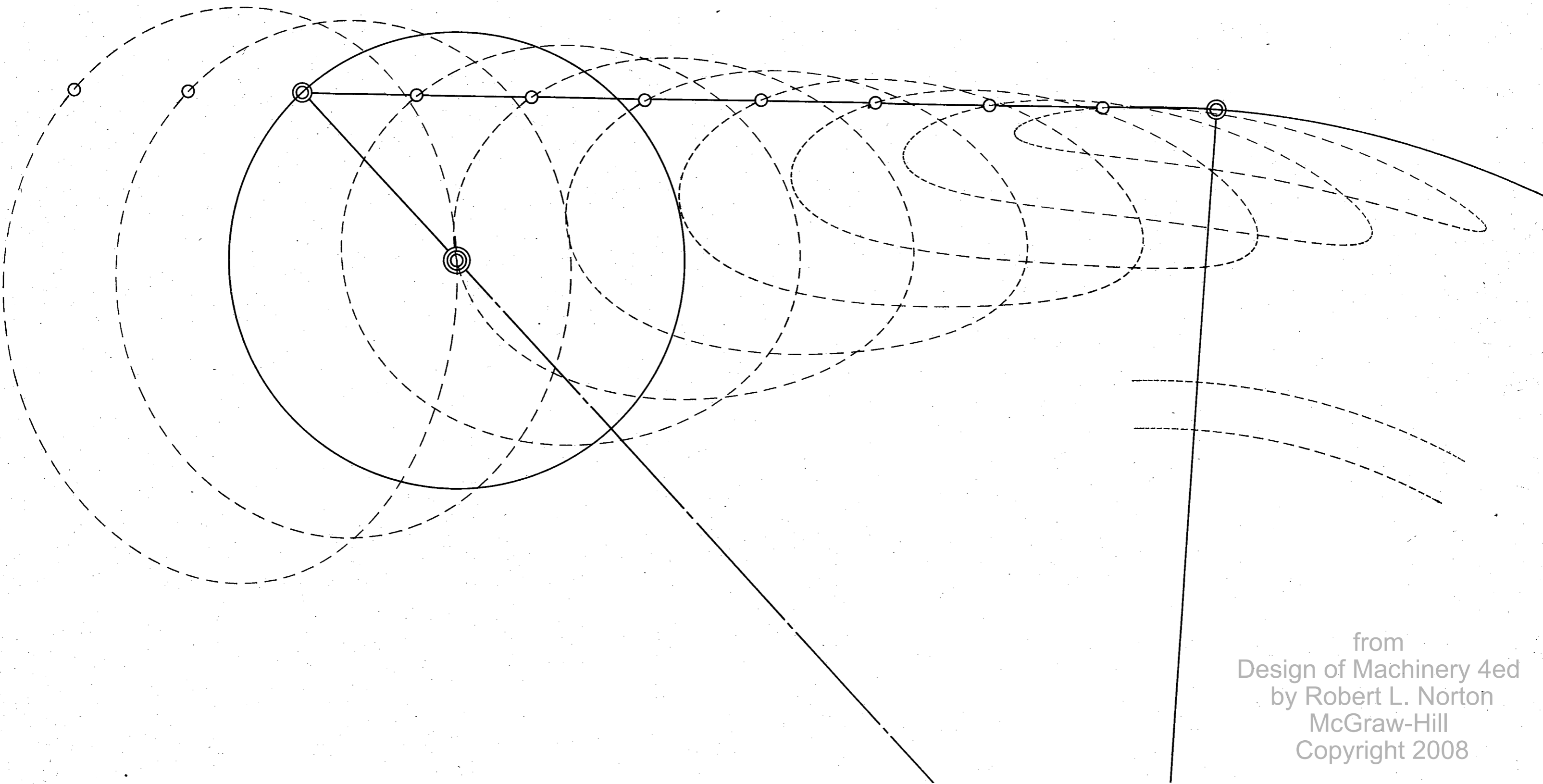
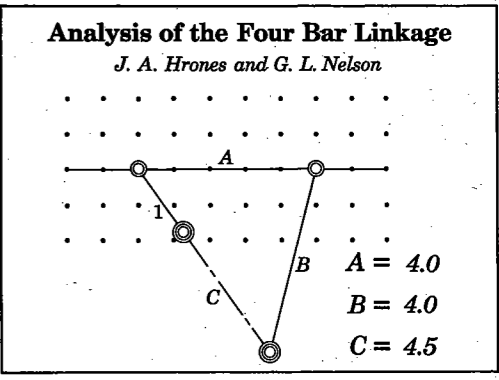

from  
Design of Machinery 4ed  
by Robert L. Norton  
McGraw-Hill  
Copyright 2008

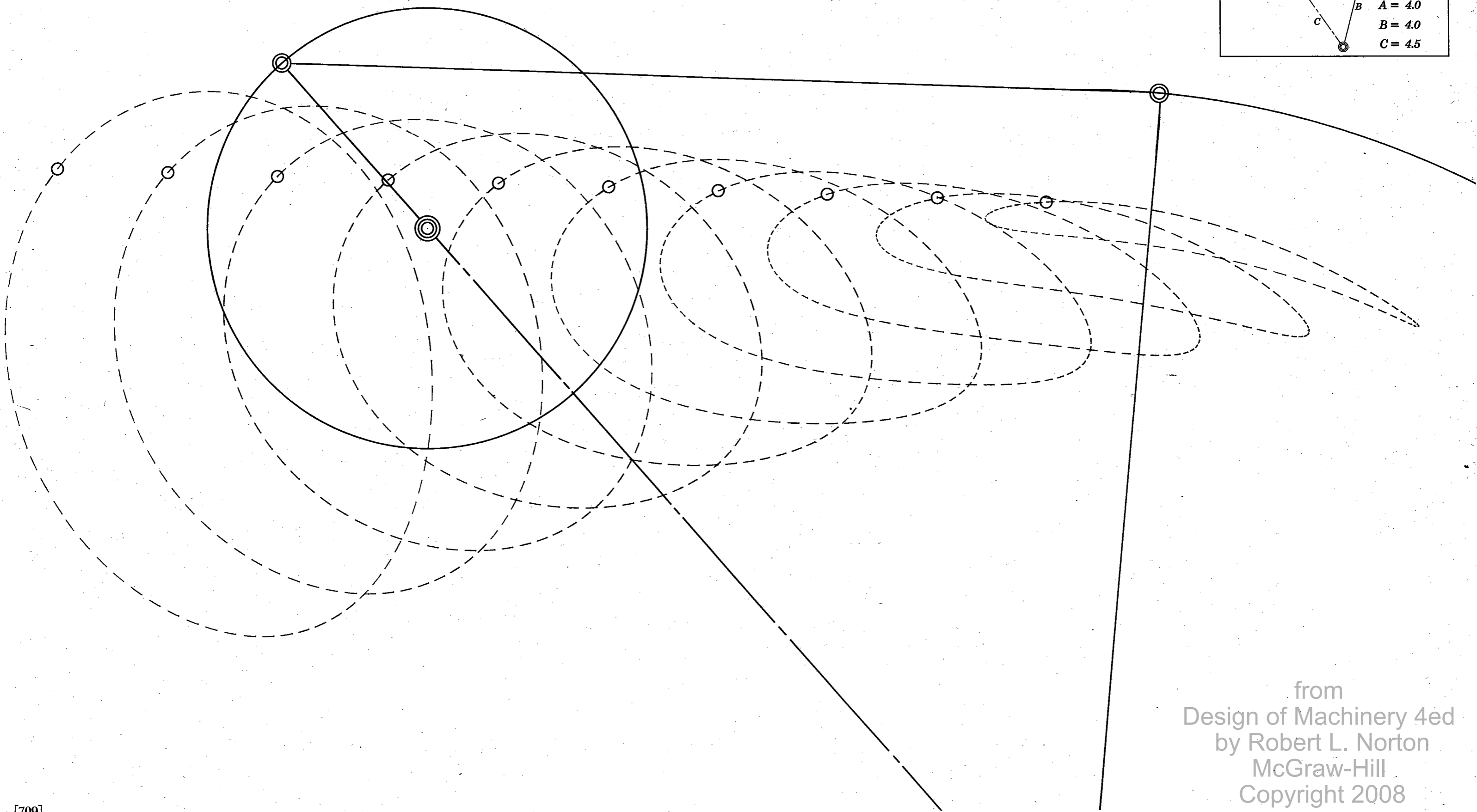
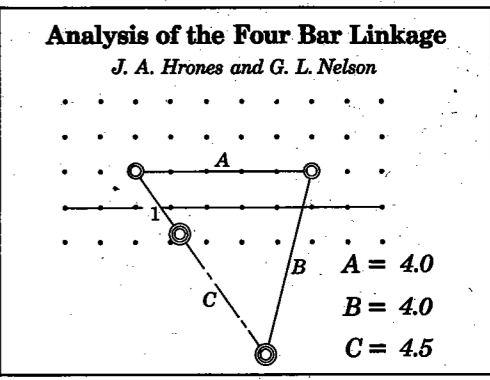

from  
 Design of Machinery 4ed  
 by Robert L. Norton  
 McGraw-Hill  
 Copyright 2008

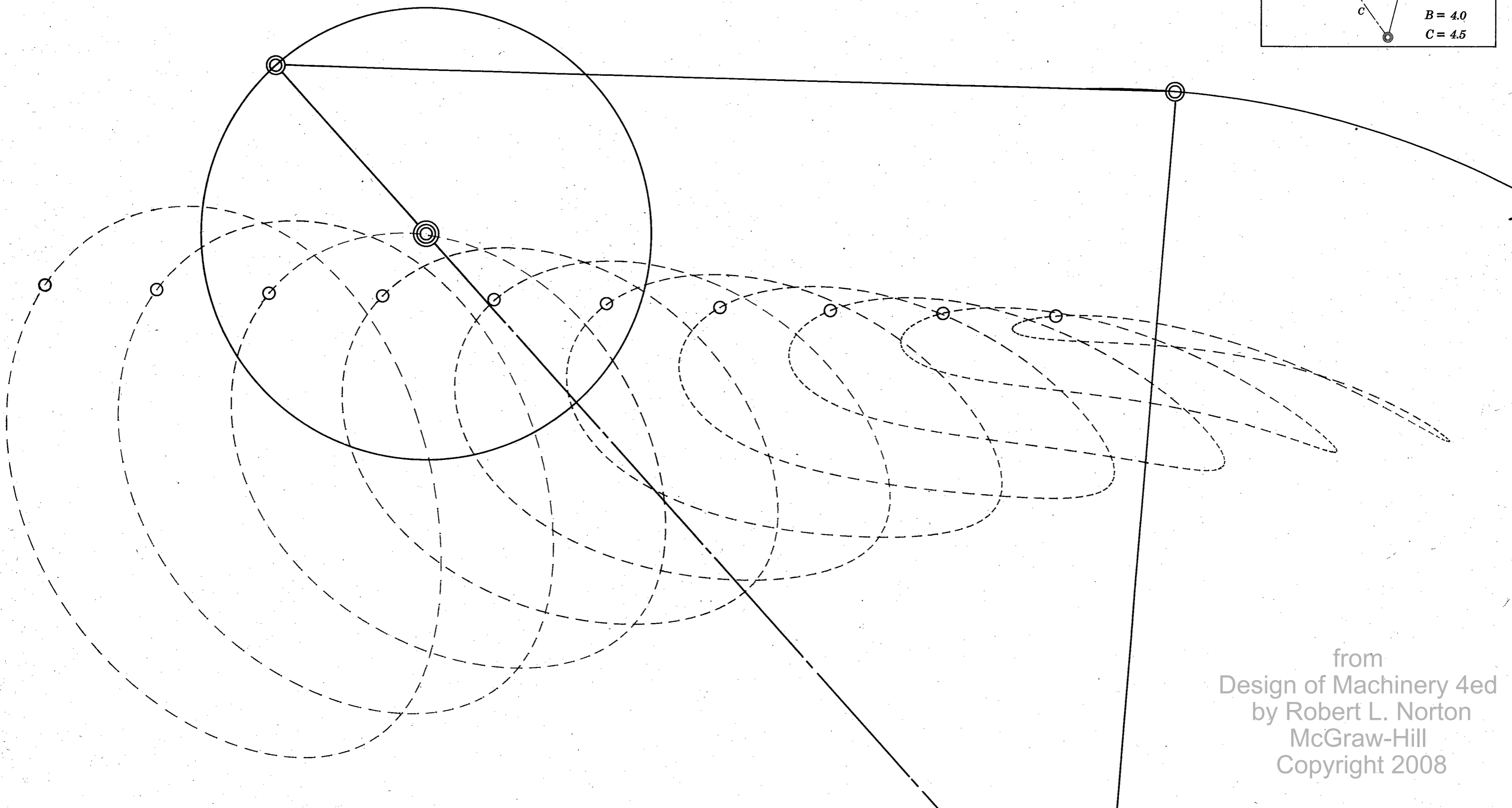
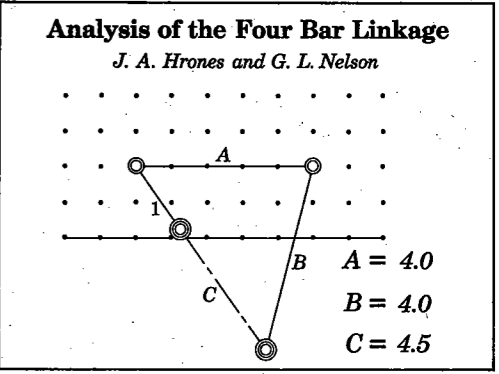

from  
 Design of Machinery 4ed  
 by Robert L. Norton  
 McGraw-Hill  
 Copyright 2008

**Analysis of the Four Bar Linkage**  
*J. A. Hrones and G. L. Nelson*

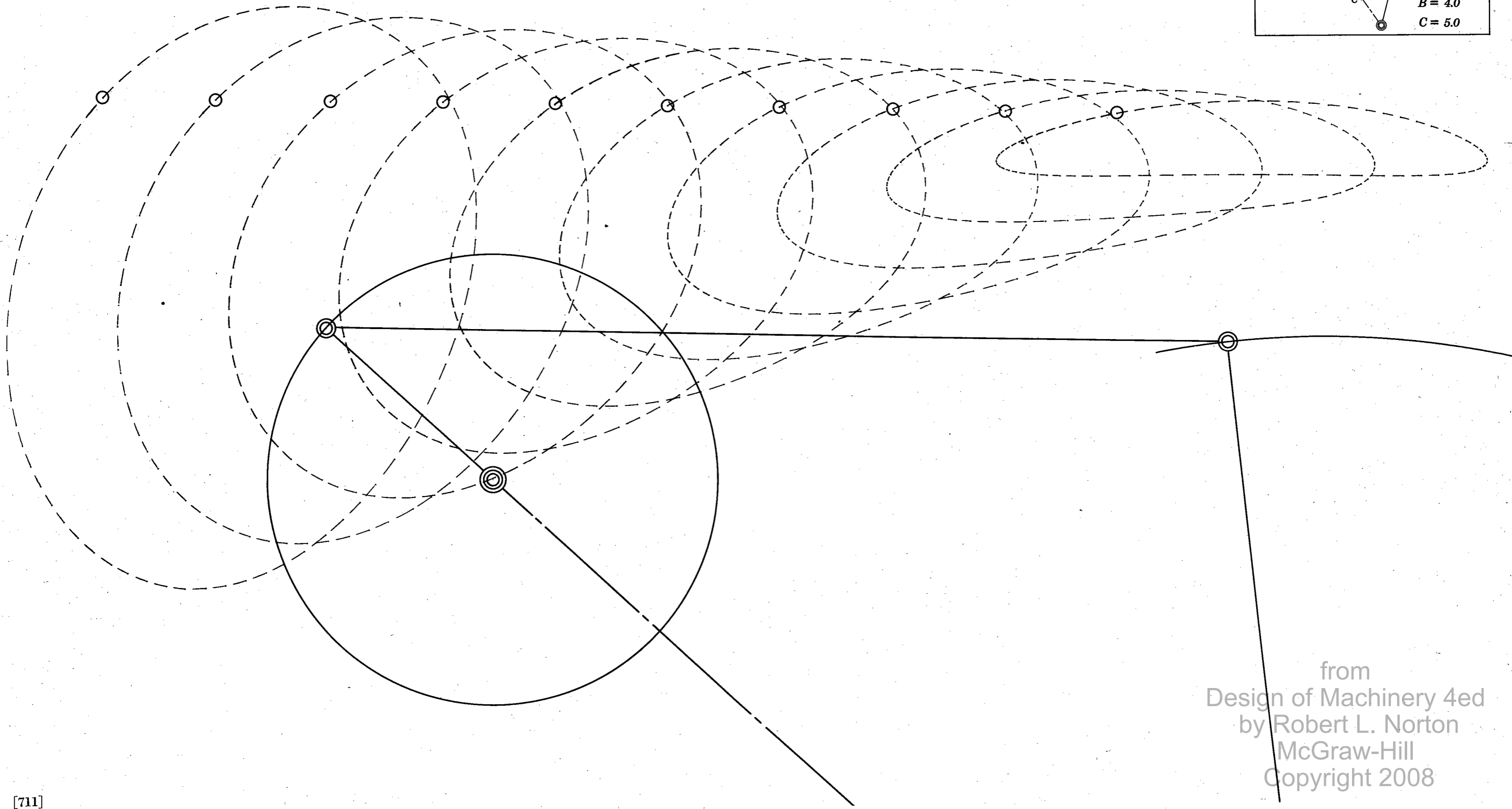
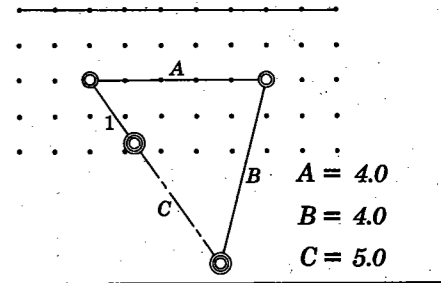

from  
Design of Machinery 4ed  
by Robert L. Norton  
McGraw-Hill  
Copyright 2008

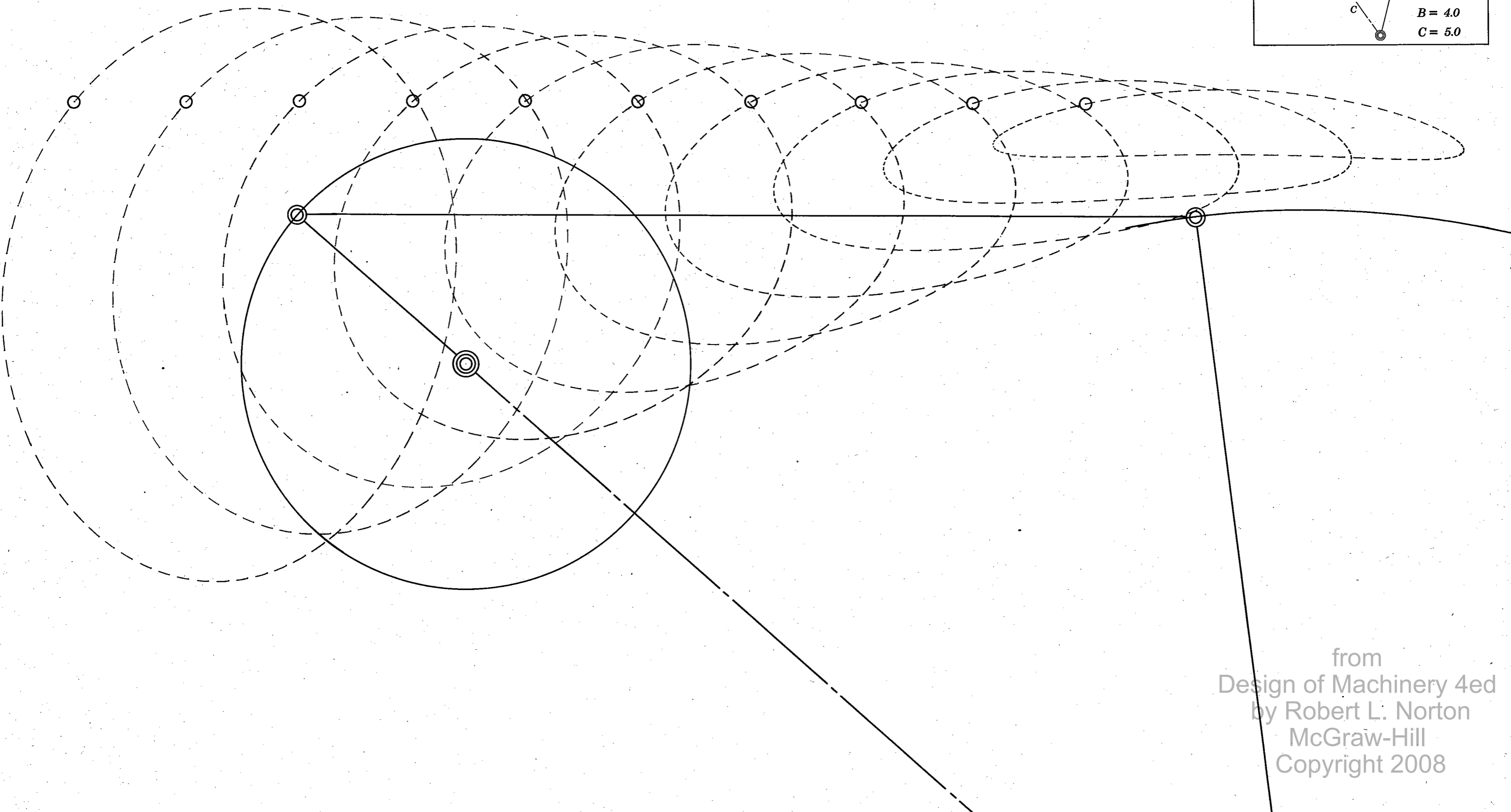
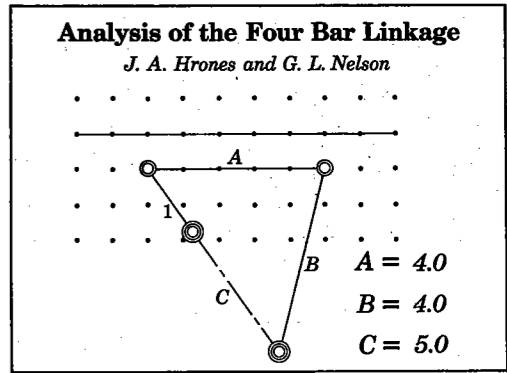

from  
Design of Machinery 4ed  
by Robert L. Norton  
McGraw-Hill  
Copyright 2008

**Analysis of the Four Bar Linkage**

*J. A. Hrones and G. L. Nelson*

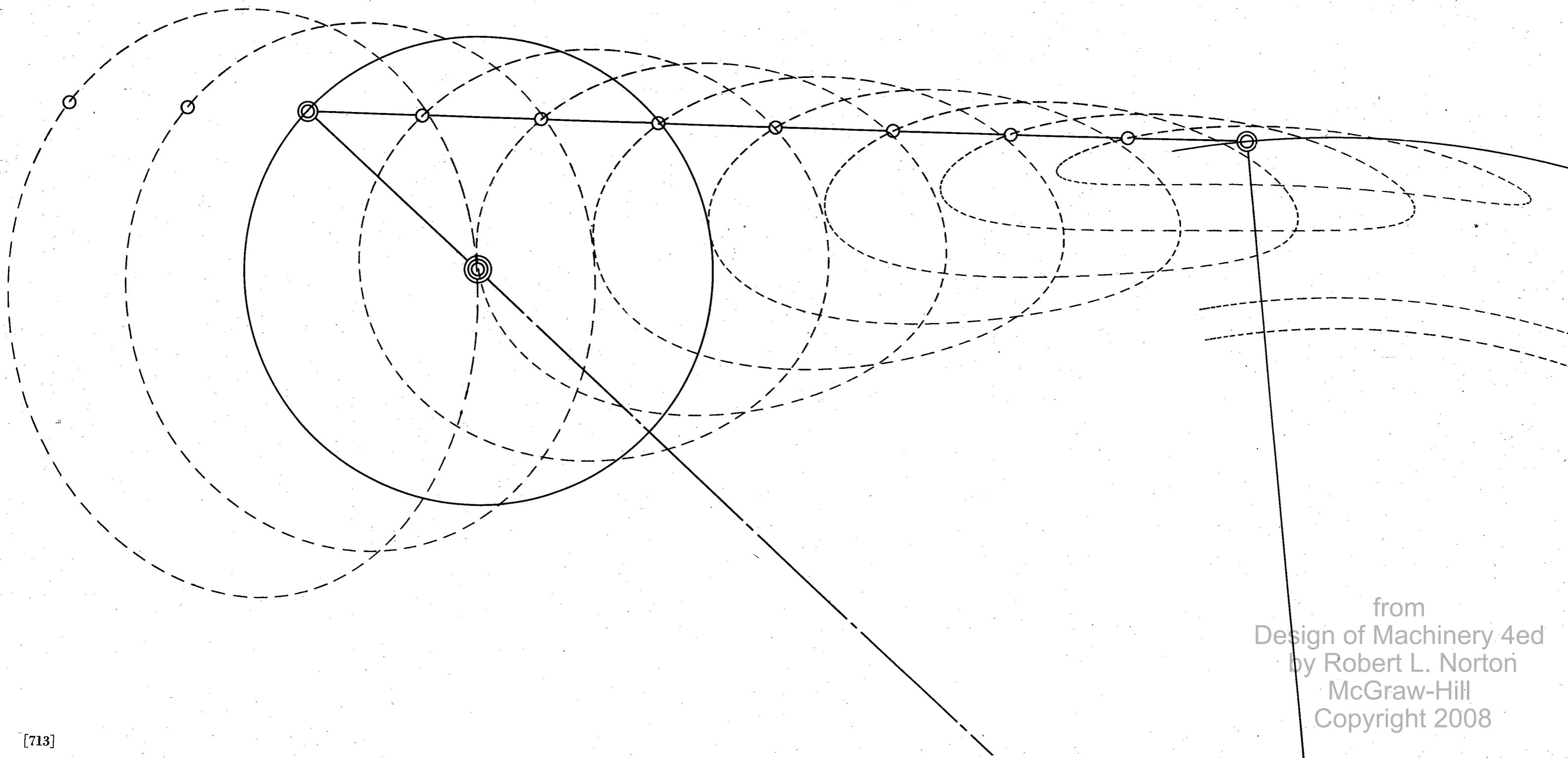
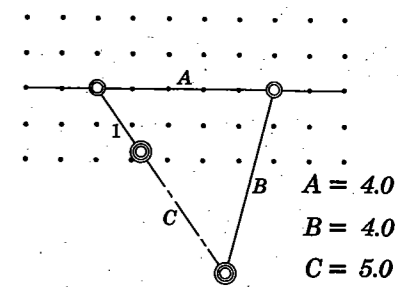

from  
Design of Machinery 4ed  
by Robert L. Norton  
McGraw-Hill  
Copyright 2008

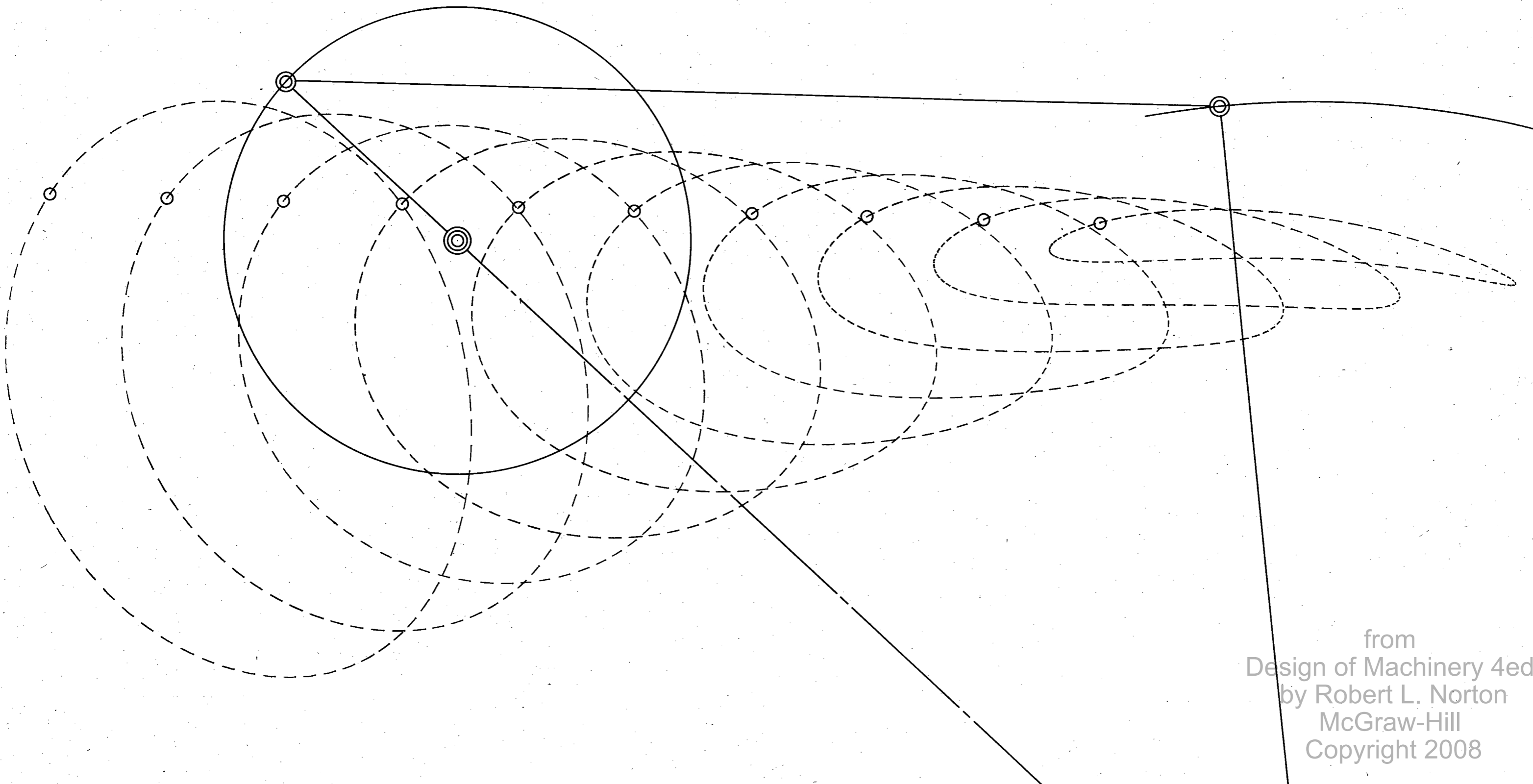
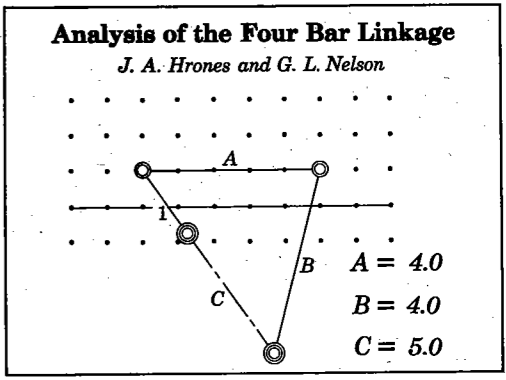

from  
Design of Machinery 4ed  
by Robert L. Norton  
McGraw-Hill  
Copyright 2008

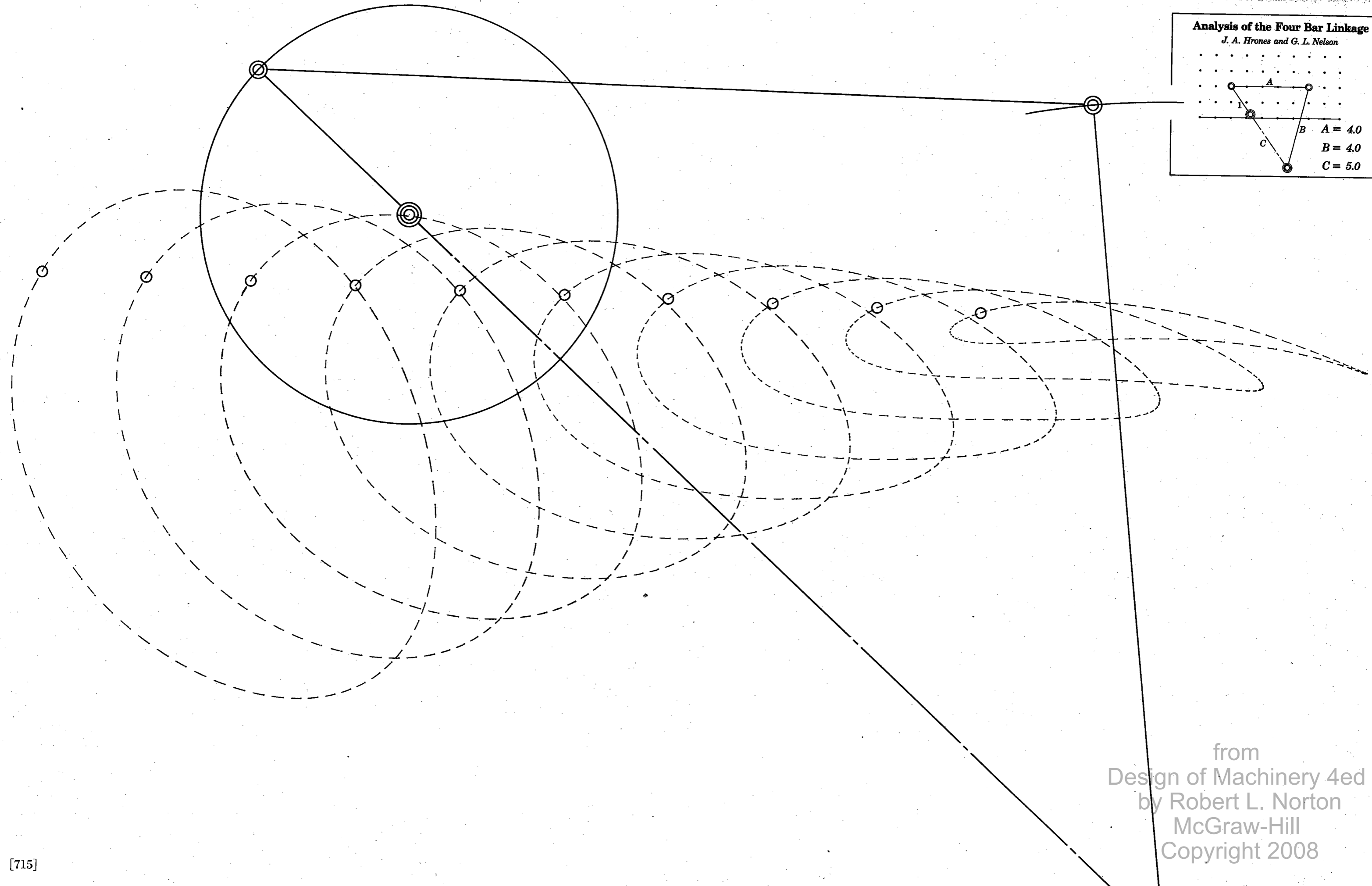
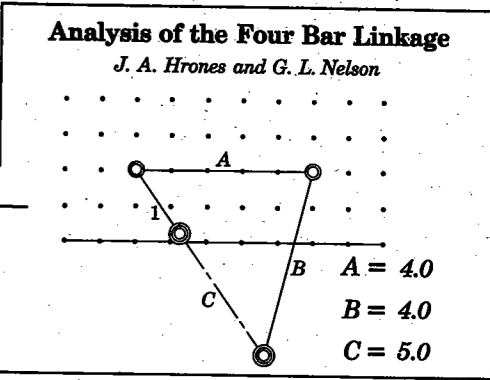

from  
 Design of Machinery 4ed  
 by Robert L. Norton  
 McGraw-Hill  
 Copyright 2008



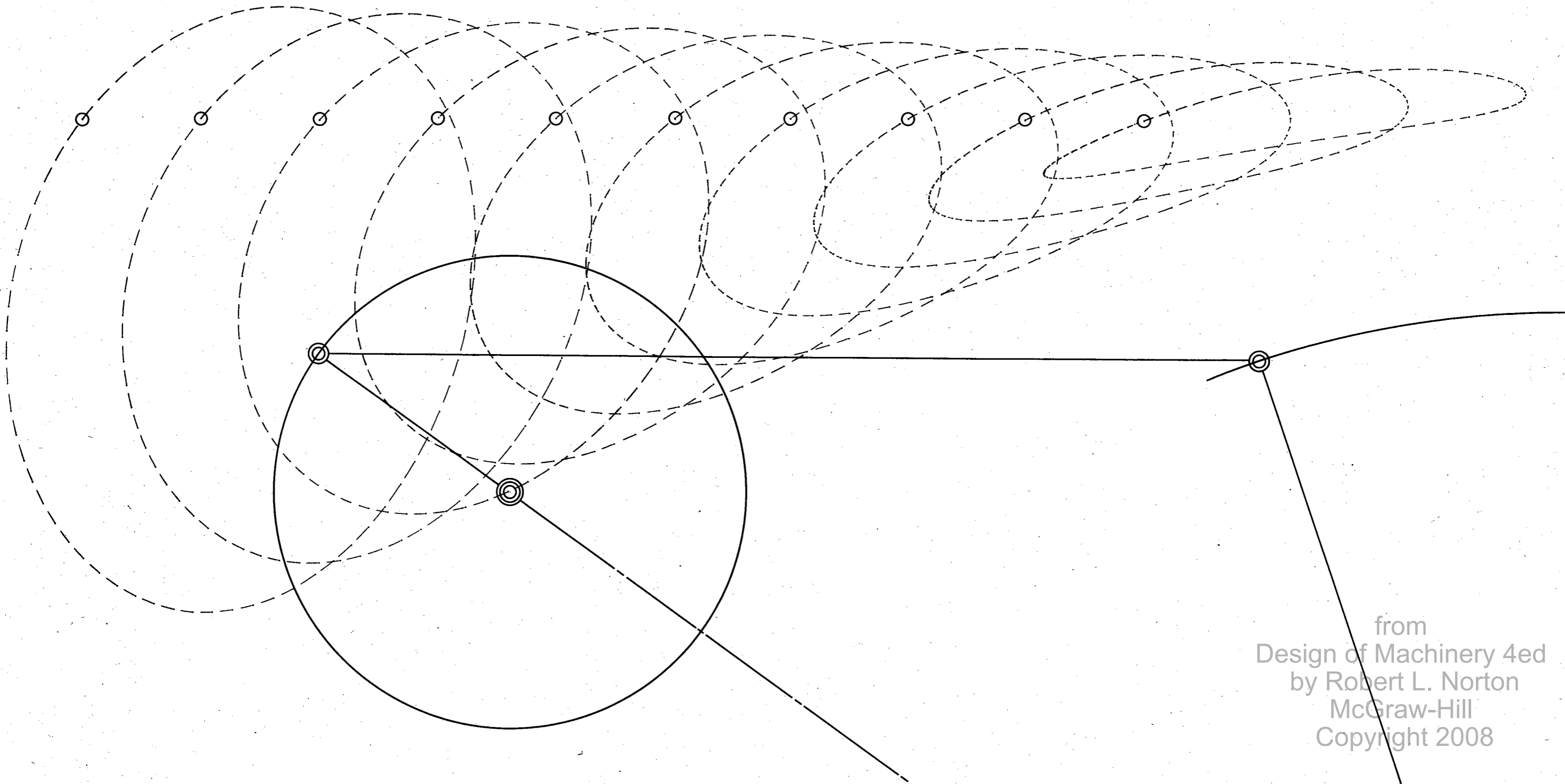
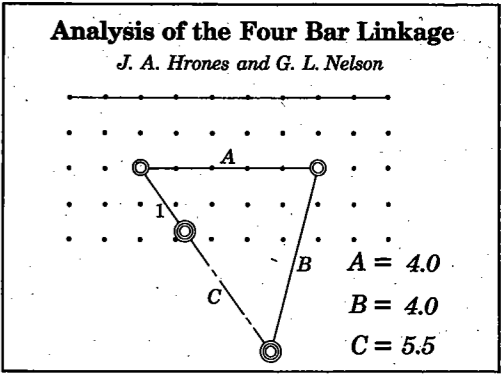

from  
Design of Machinery 4ed  
by Robert L. Norton  
McGraw-Hill  
Copyright 2008

**Analysis of the Four Bar Linkage**

*J. A. Hrones and G. L. Nelson*

.....

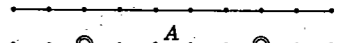

$A = 4.0$

$B = 4.0$

$C = 5.5$

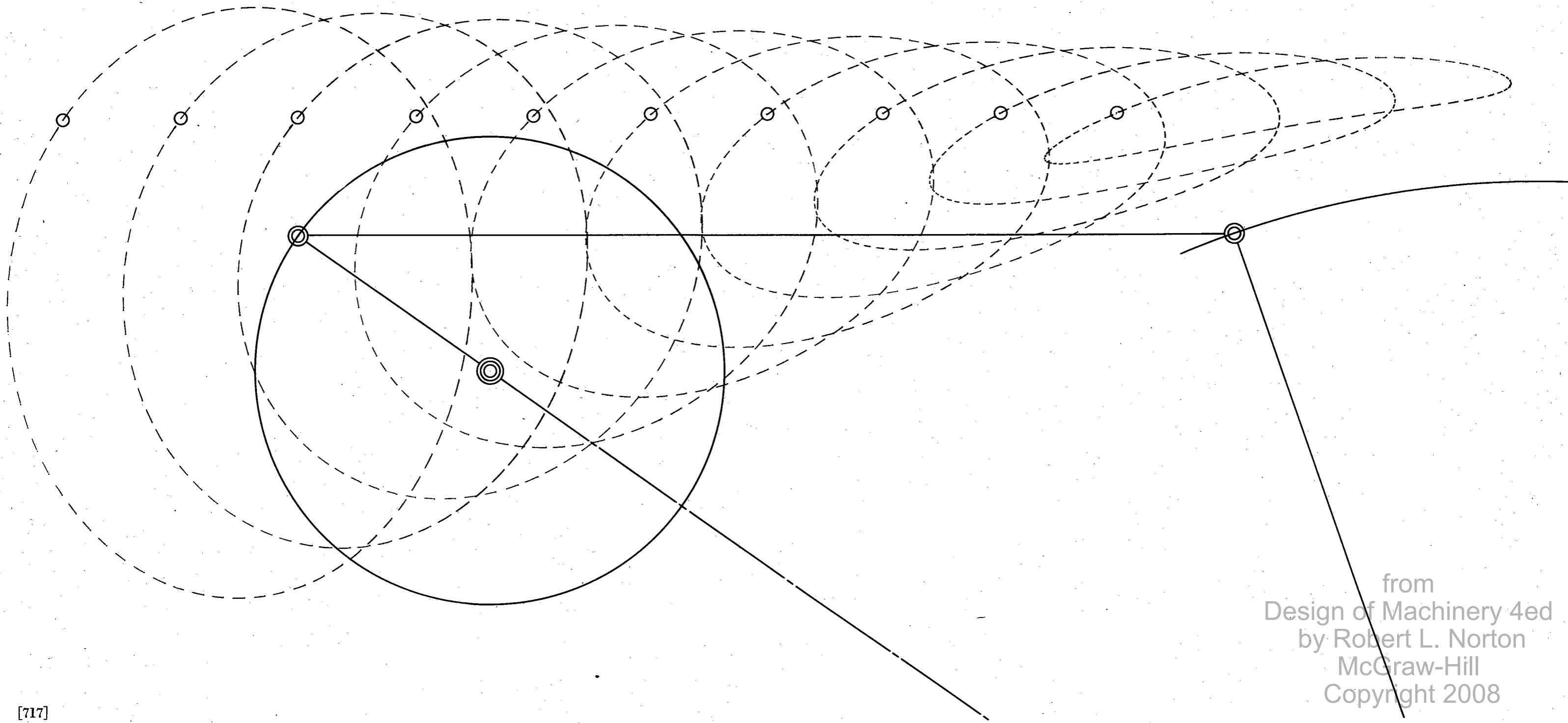

from  
Design of Machinery 4ed  
by Robert L. Norton  
McGraw-Hill  
Copyright 2008

**Analysis of the Four Bar Linkage**  
*J. A. Hrones and G. L. Nelson*

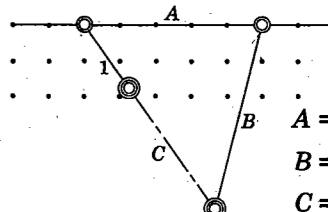

$A = 4.0$   
 $B = 4.0$   
 $C = 5.5$

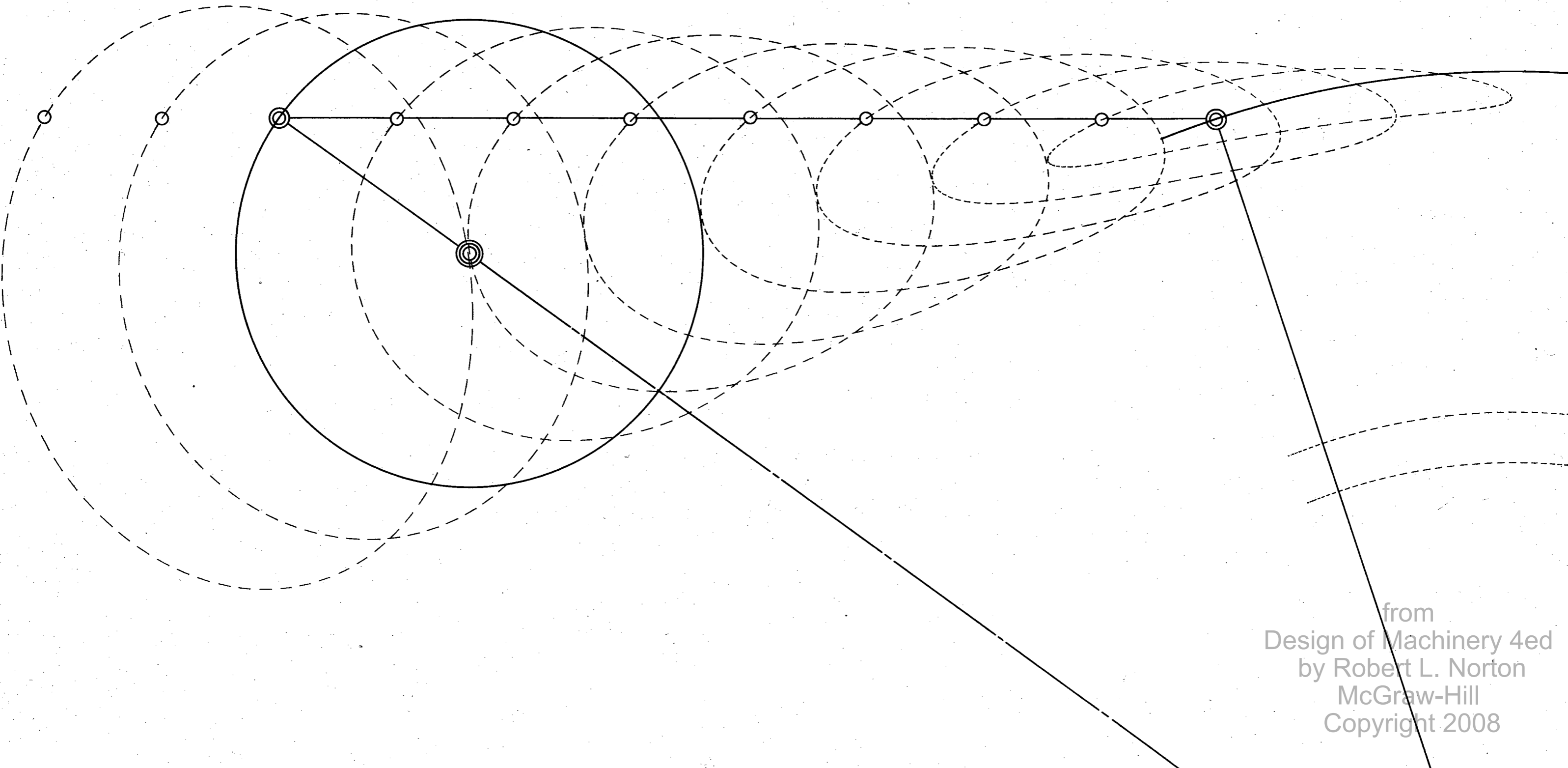

from  
Design of Machinery 4ed  
by Robert L. Norton  
McGraw-Hill  
Copyright 2008

**Analysis of the Four Bar Linkage**  
*J. A. Hrones and G. L. Nelson*

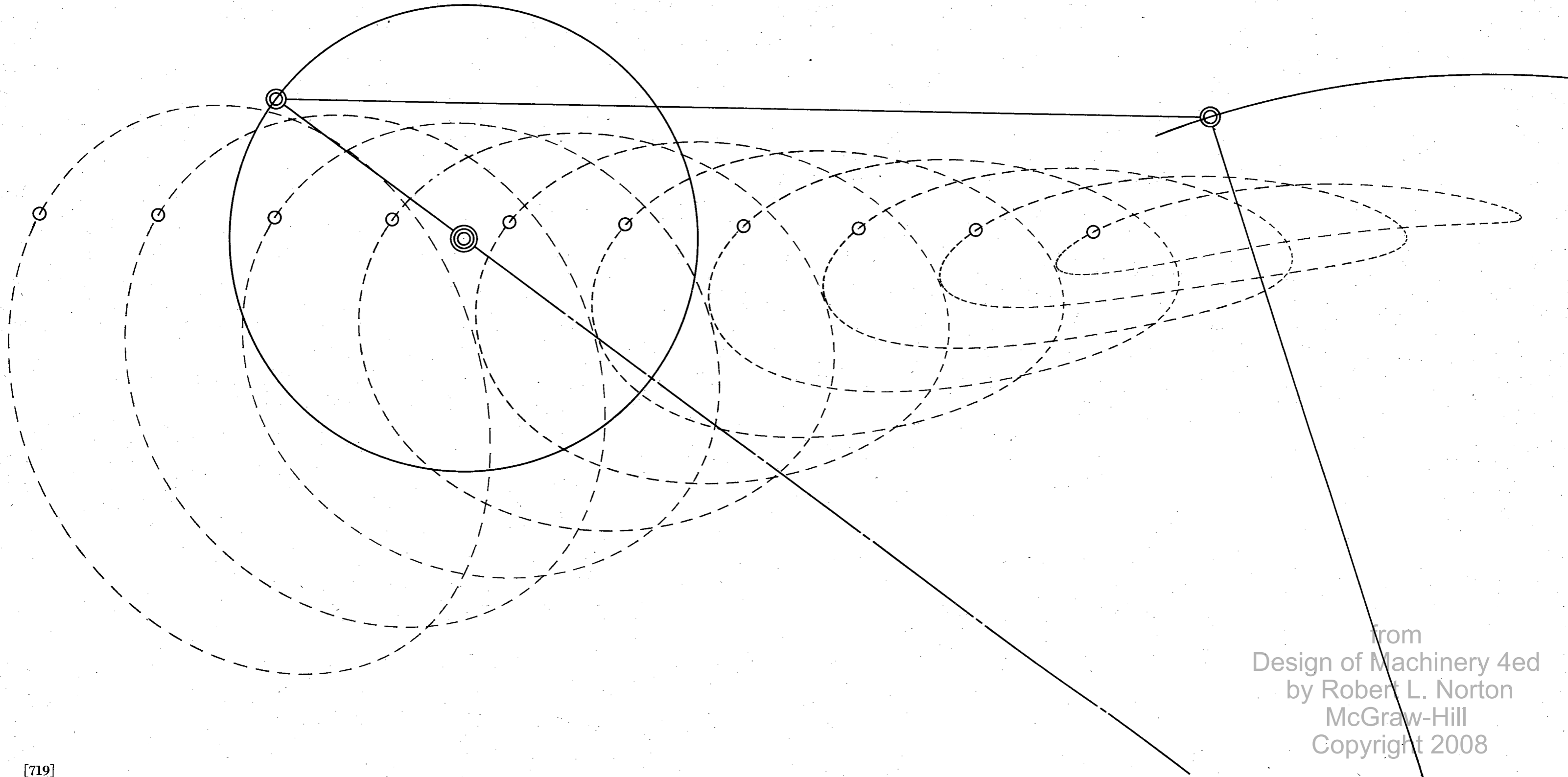
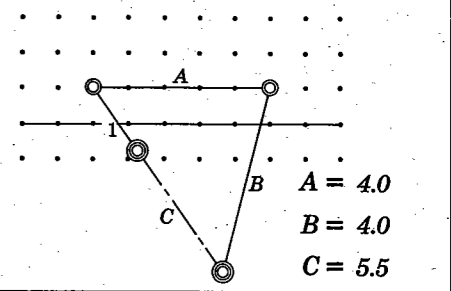

from  
Design of Machinery 4ed  
by Robert L. Norton  
McGraw-Hill  
Copyright 2008

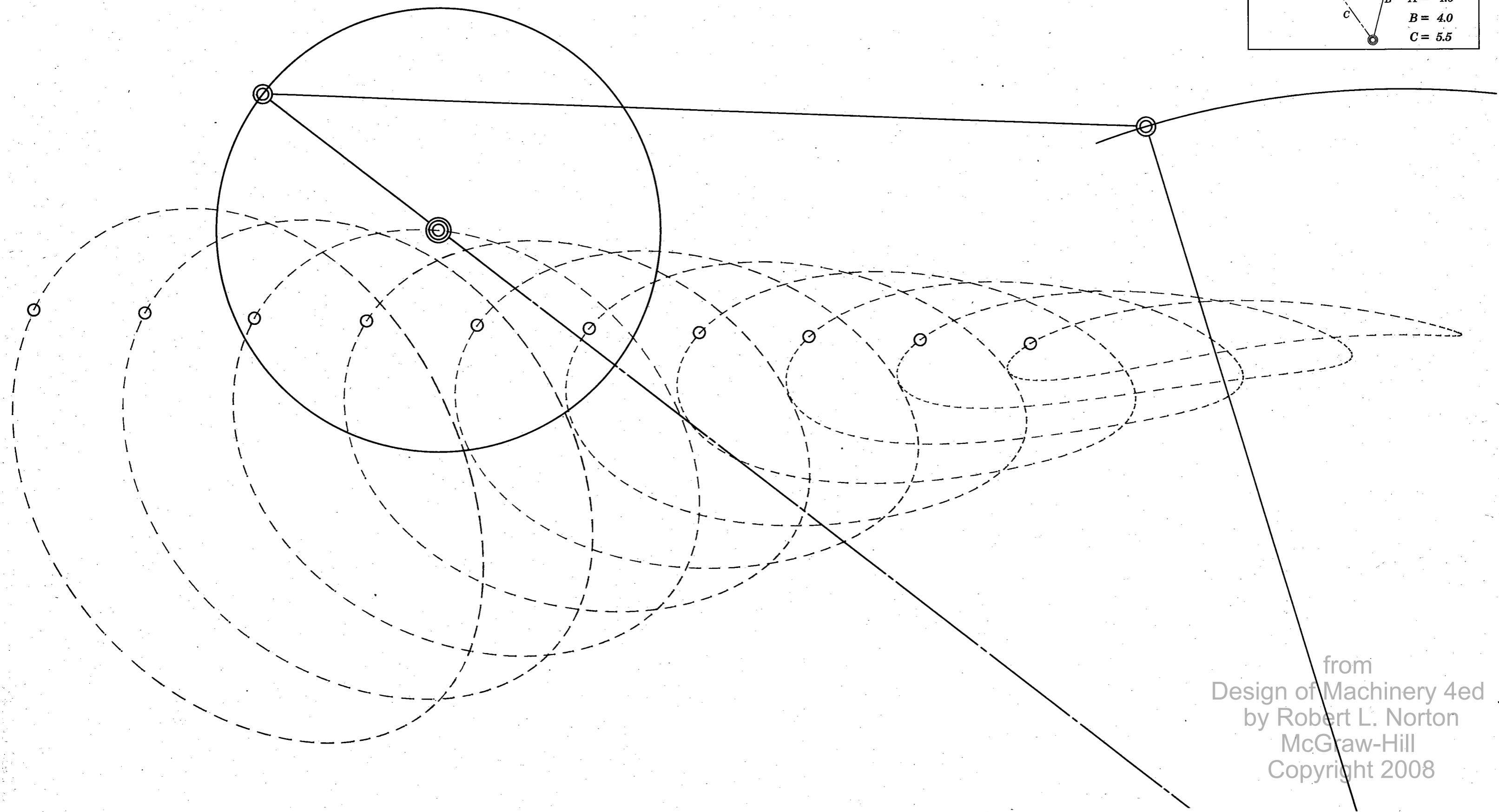
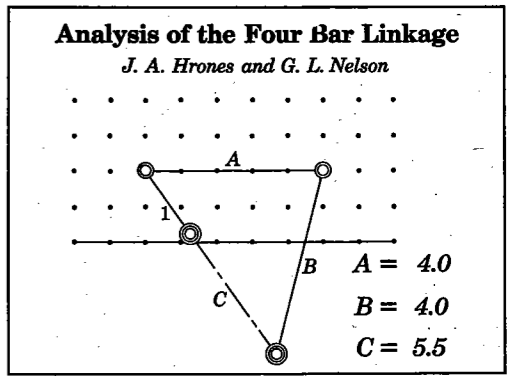

from  
Design of Machinery 4ed  
by Robert L. Norton  
McGraw-Hill  
Copyright 2008

**Analysis of the Four Bar Linkage**

*J. A. Hrones and G. L. Nelson.*

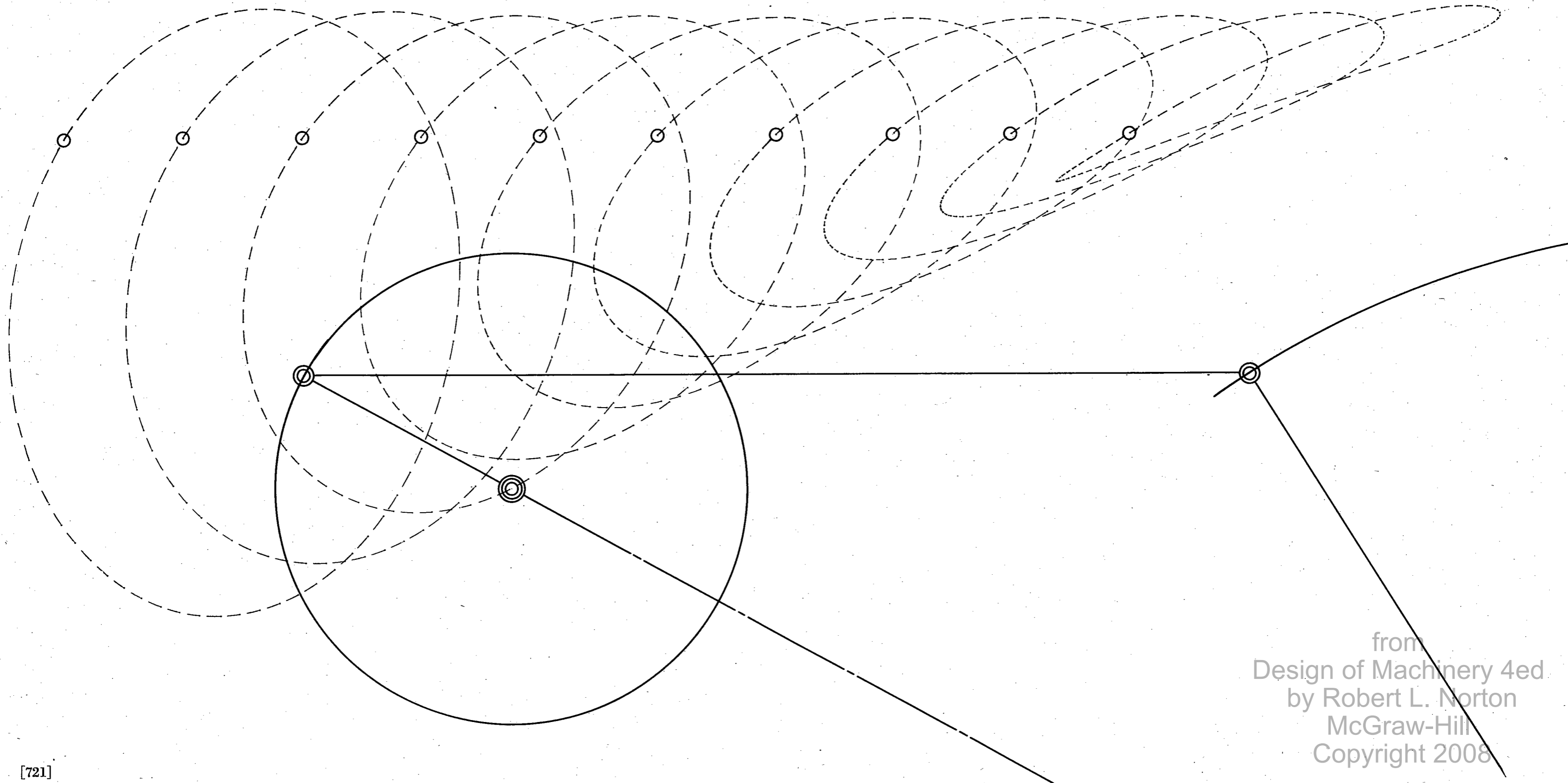
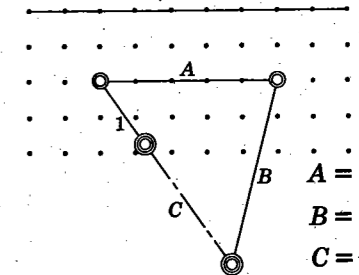

from  
 Design of Machinery 4ed  
 by Robert L. Norton  
 McGraw-Hill  
 Copyright 2008

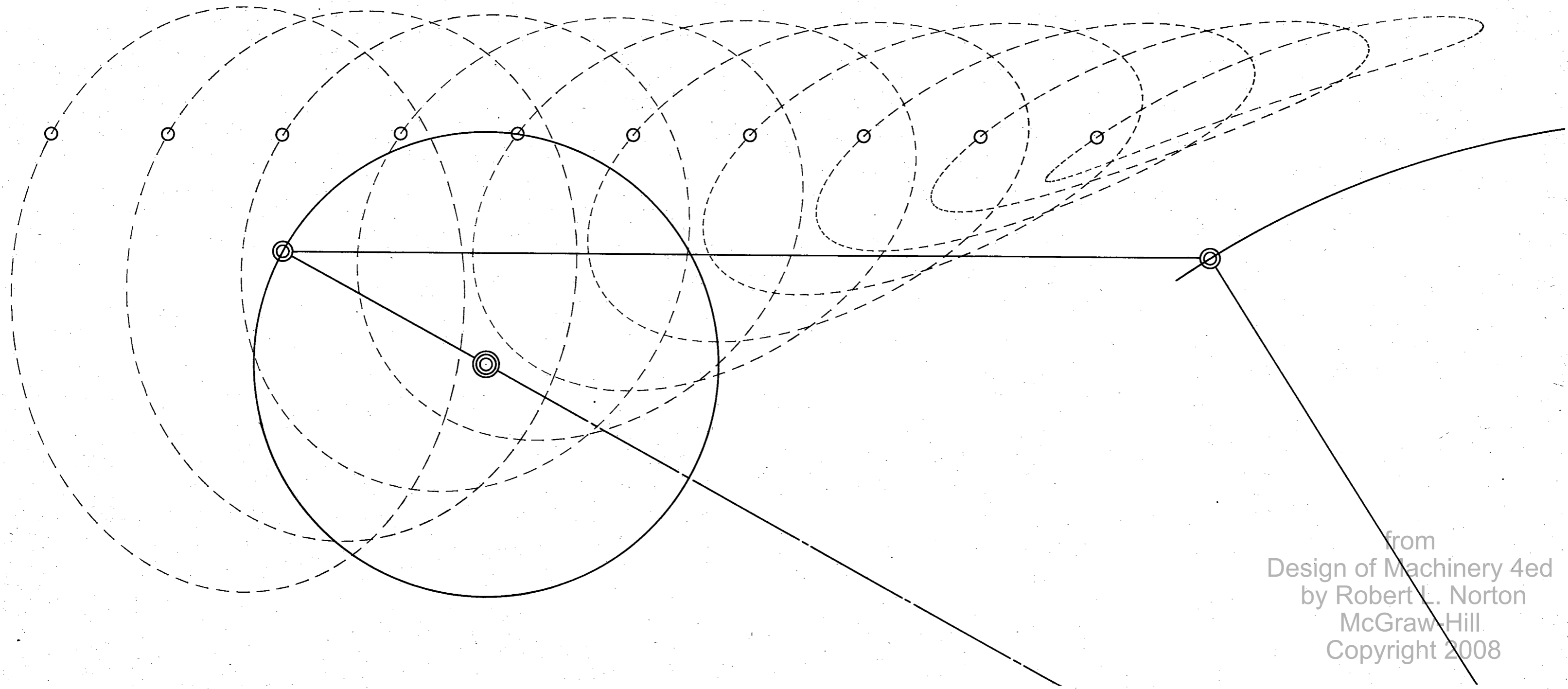
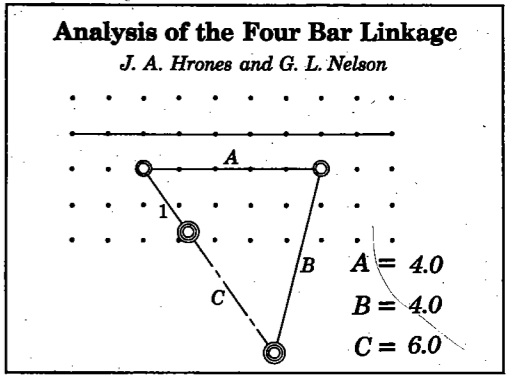

from  
Design of Machinery 4ed  
by Robert L. Norton  
McGraw-Hill  
Copyright 2008

**Analysis of the Four Bar Linkage**  
*J. A. Hrones and G. L. Nelson*

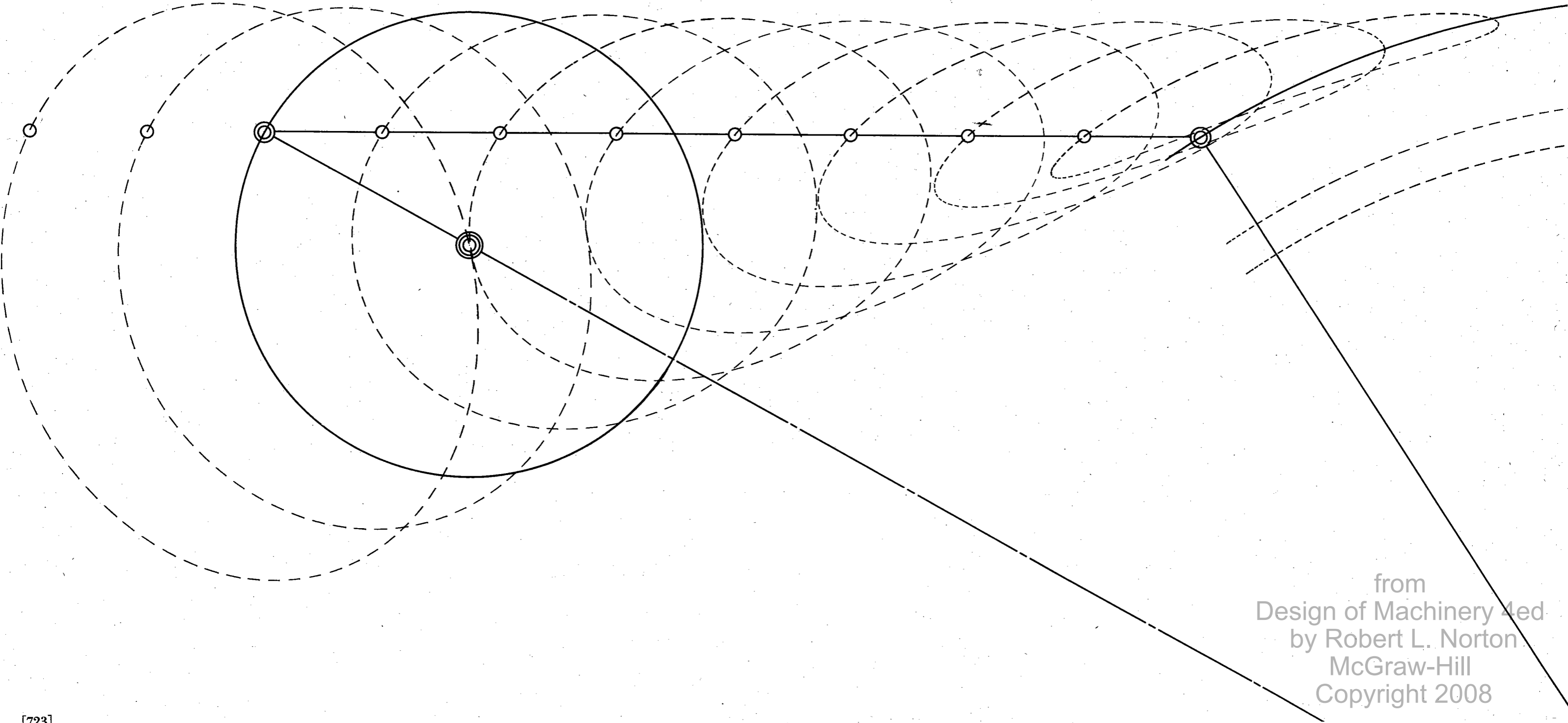
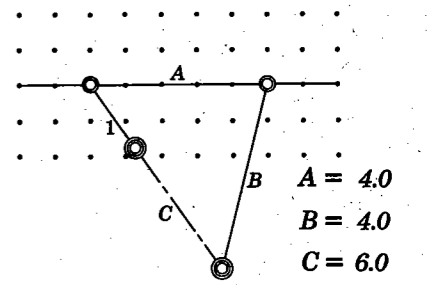

from  
Design of Machinery 4ed  
by Robert L. Norton  
McGraw-Hill  
Copyright 2008



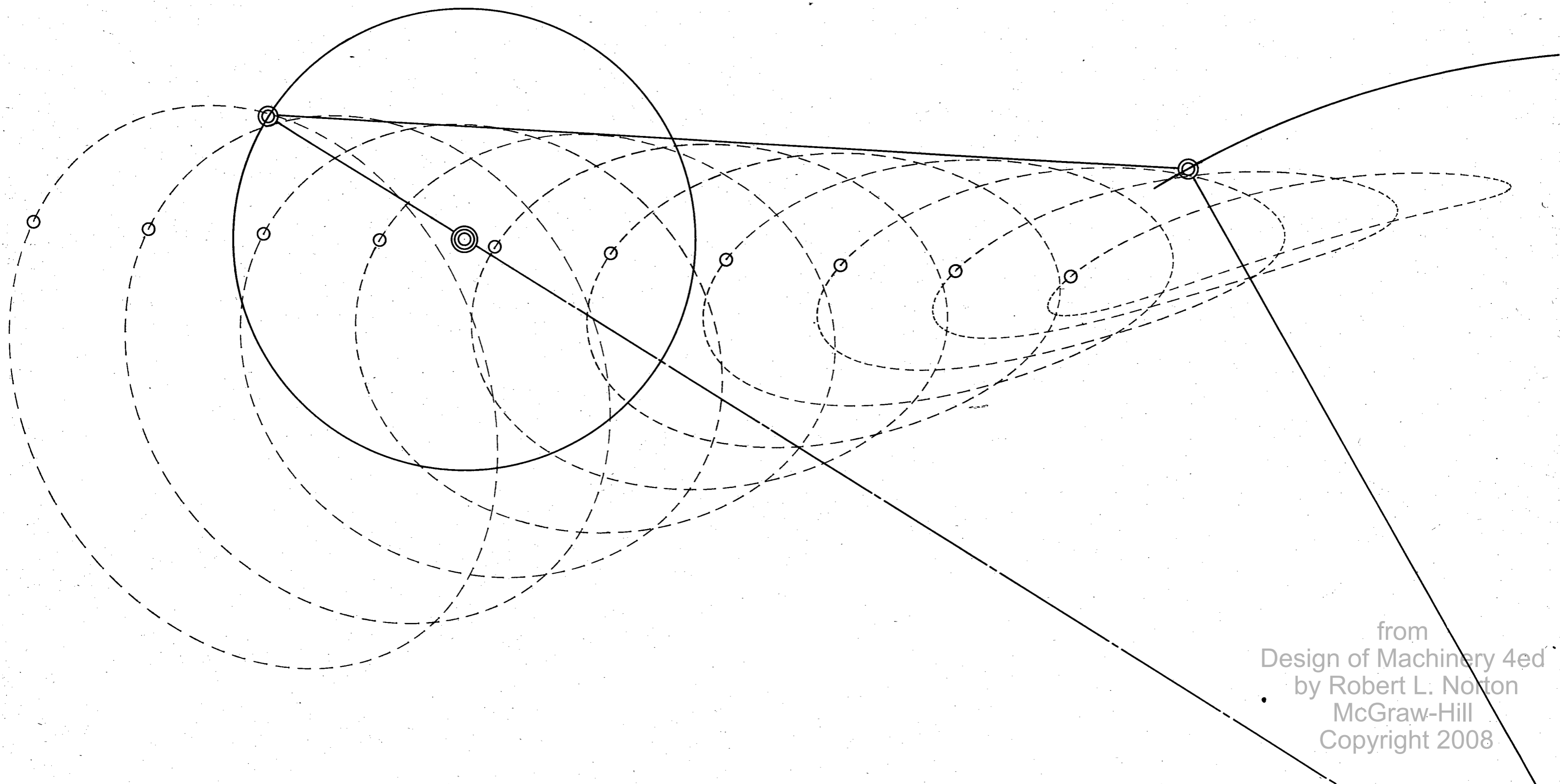
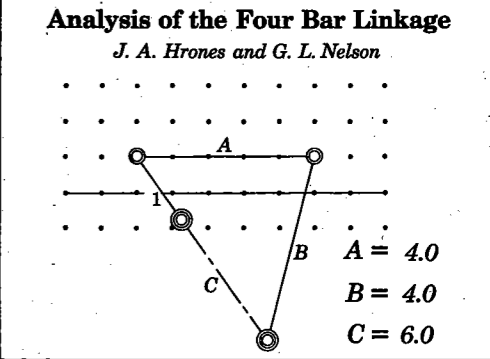

from  
Design of Machinery 4ed  
by Robert L. Norton  
McGraw-Hill  
Copyright 2008

**Analysis of the Four Bar Linkage**

*J. A. Hrones and G. L. Nelson*

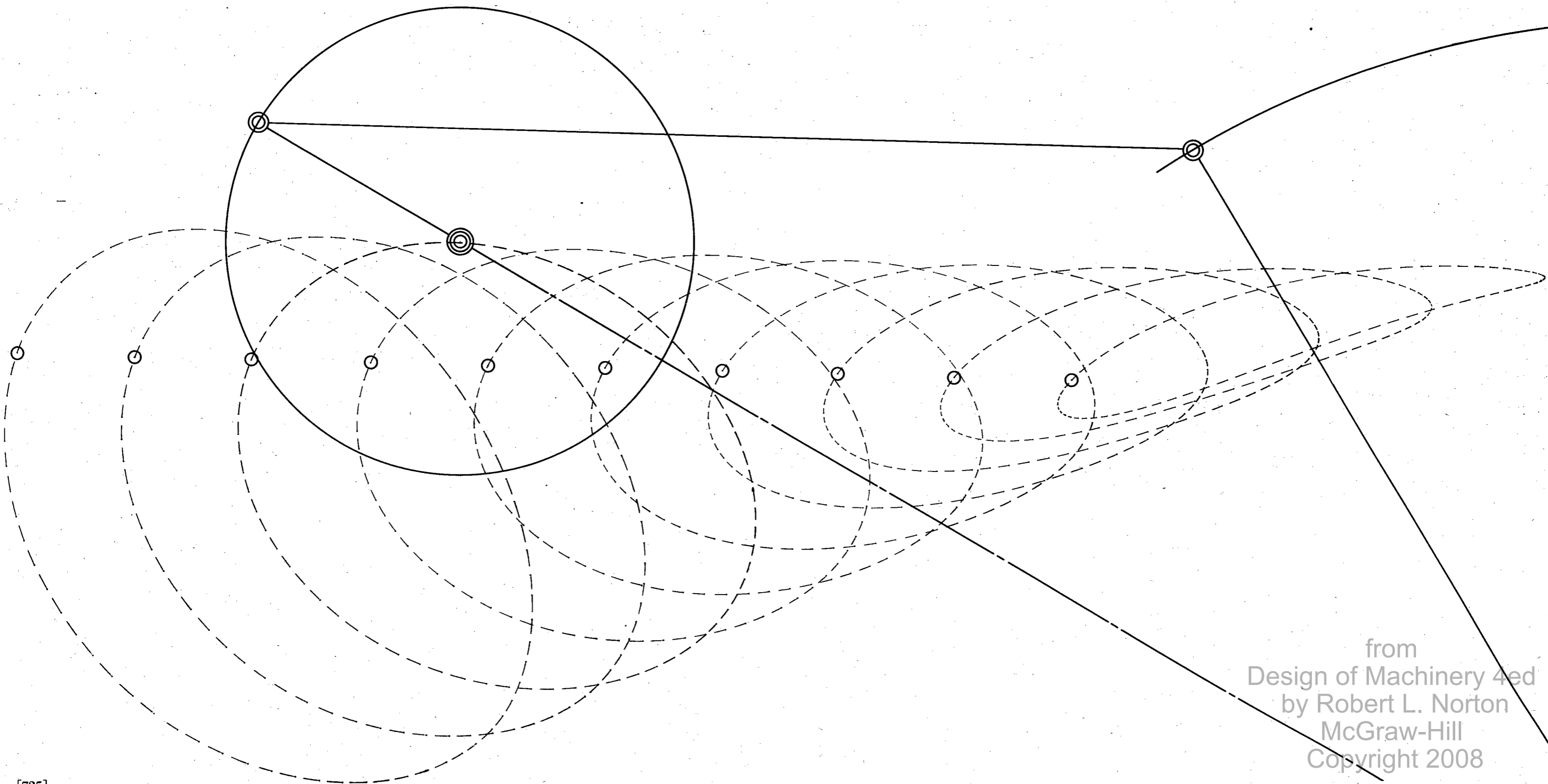
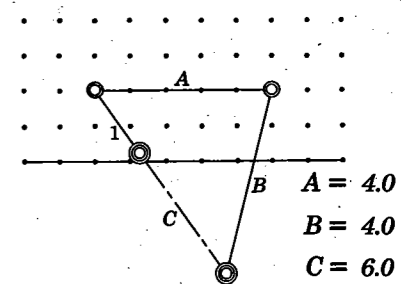

from  
Design of Machinery 4ed  
by Robert L. Norton  
McGraw-Hill  
Copyright 2008

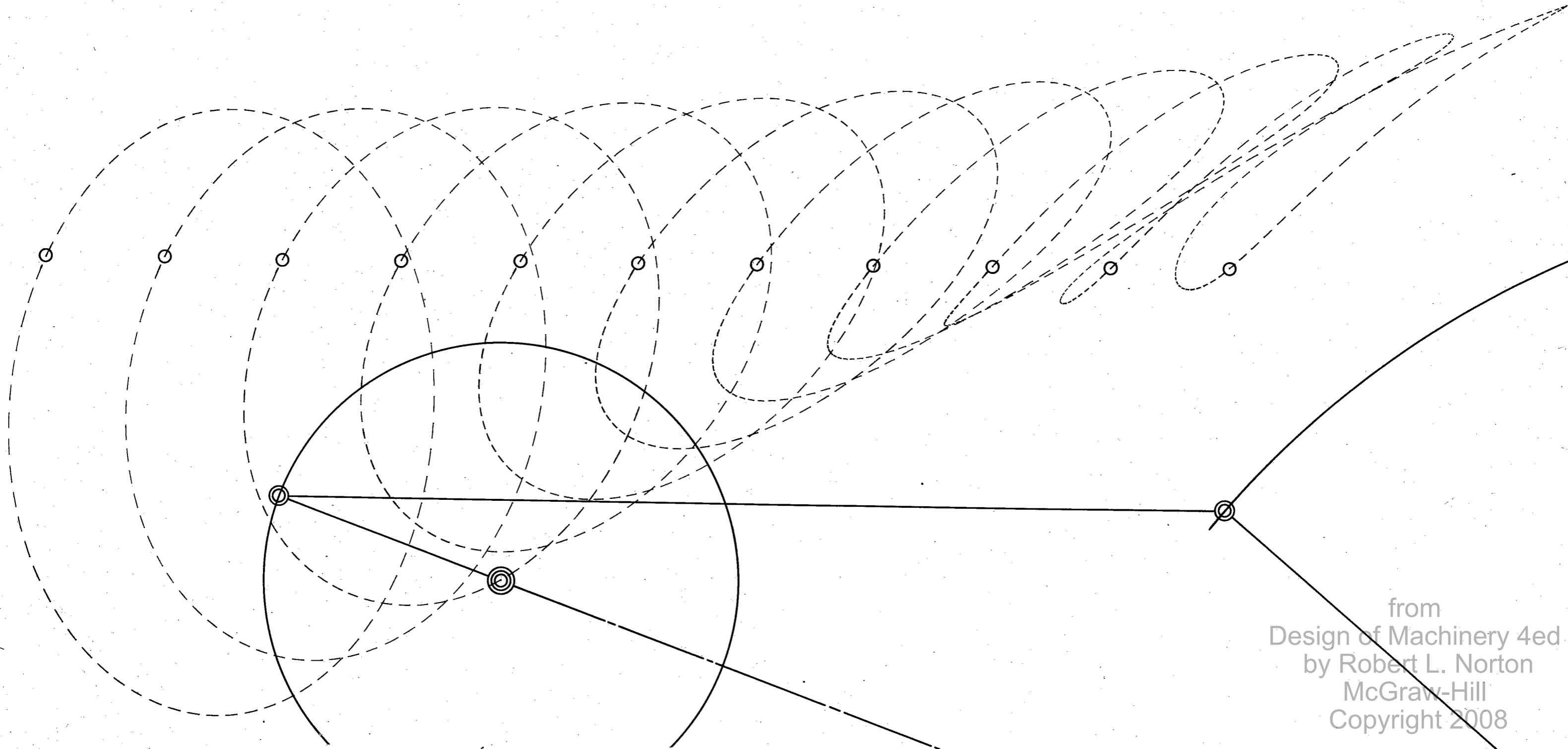
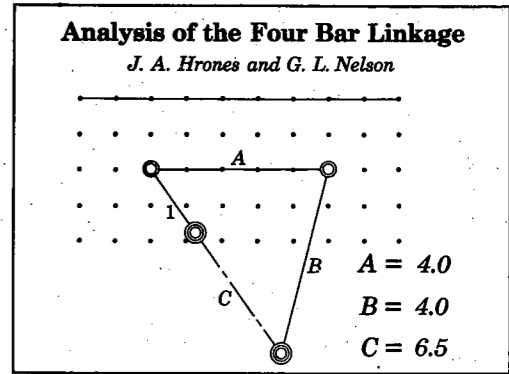

from  
Design of Machinery 4ed  
by Robert L. Norton  
McGraw-Hill  
Copyright 2008

**Analysis of the Four Bar Linkage**

*J. A. Hrones and G. L. Nelson*

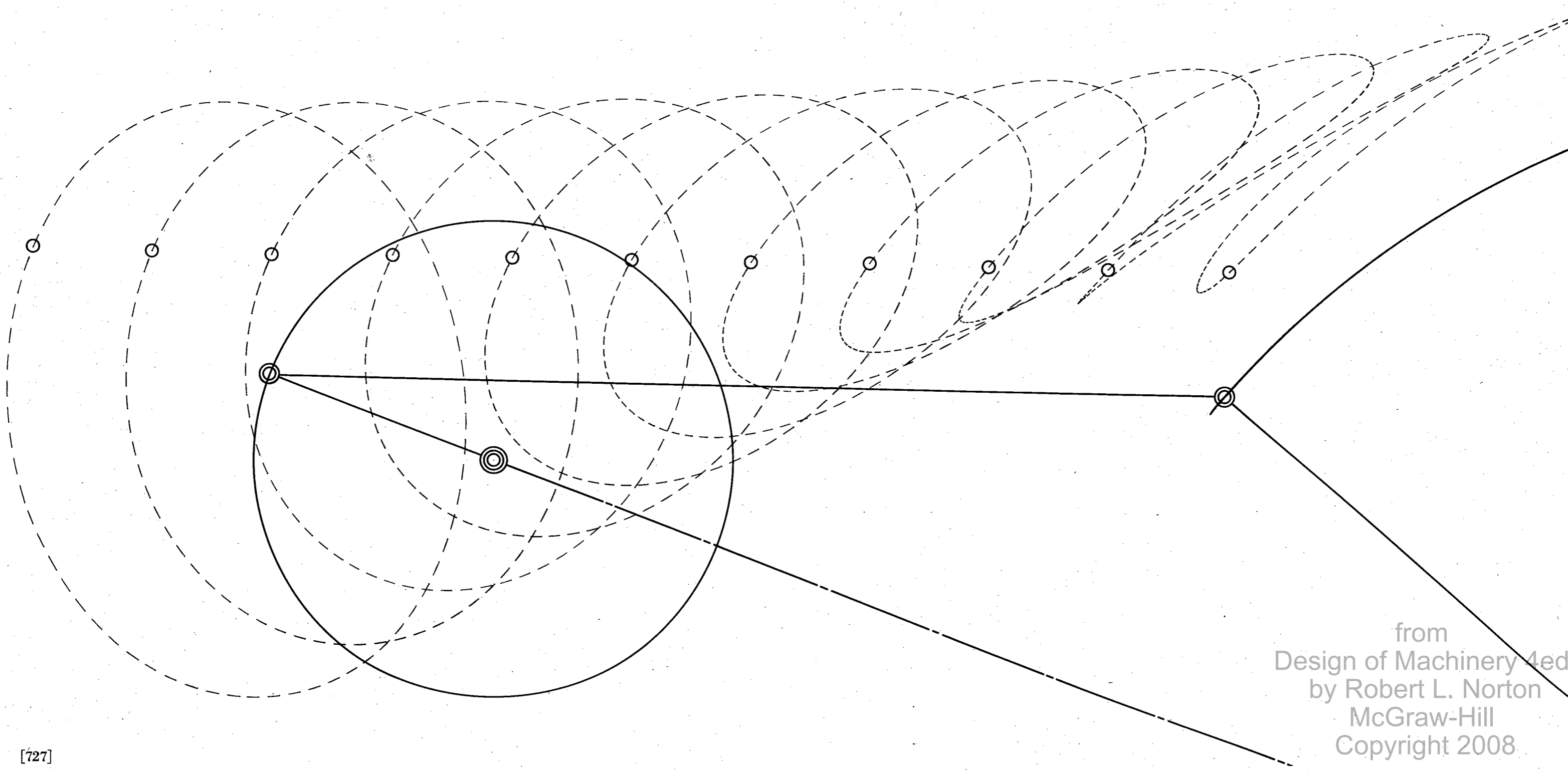
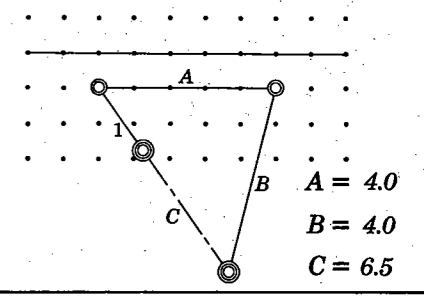

from  
Design of Machinery 4ed  
by Robert L. Norton  
McGraw-Hill  
Copyright 2008

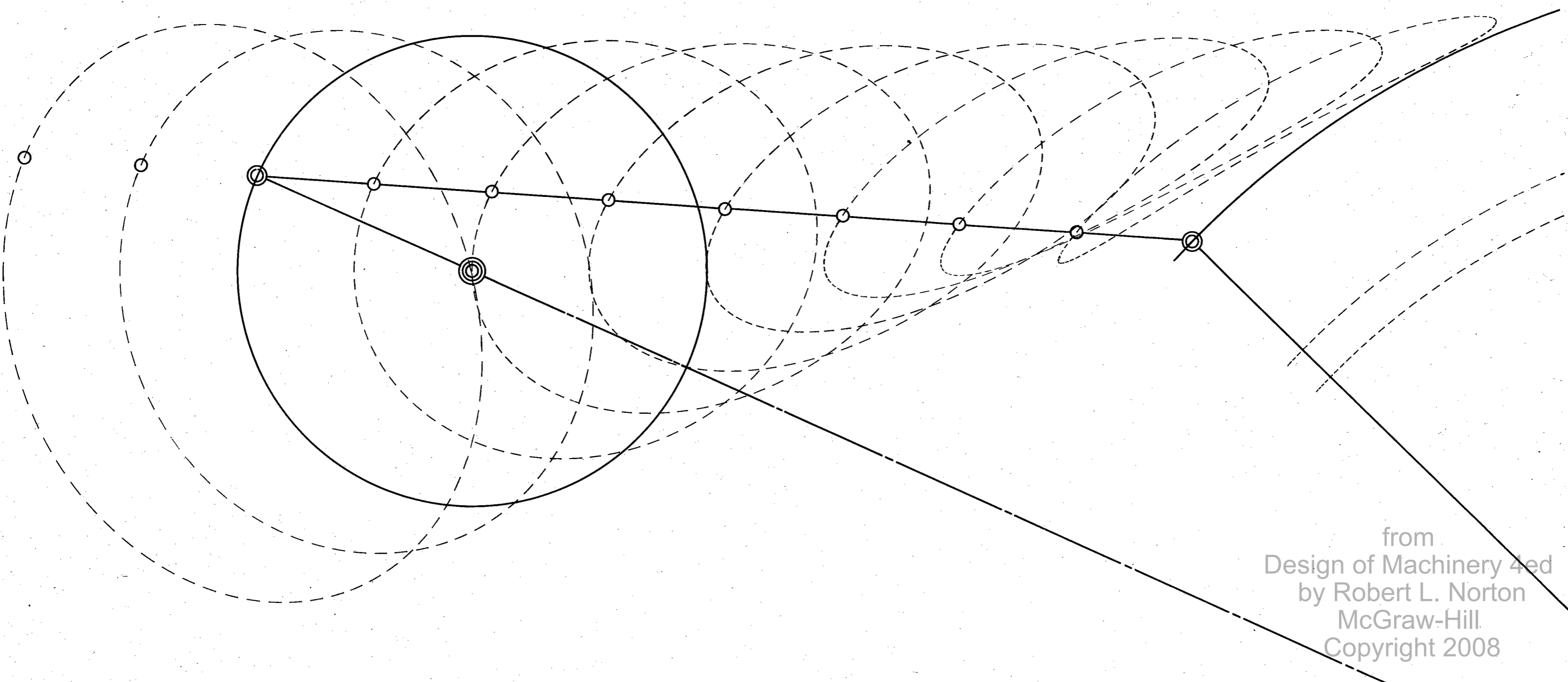
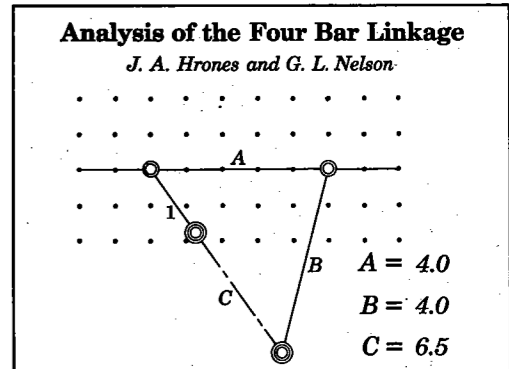

from  
Design of Machinery 4ed  
by Robert L. Norton  
McGraw-Hill  
Copyright 2008

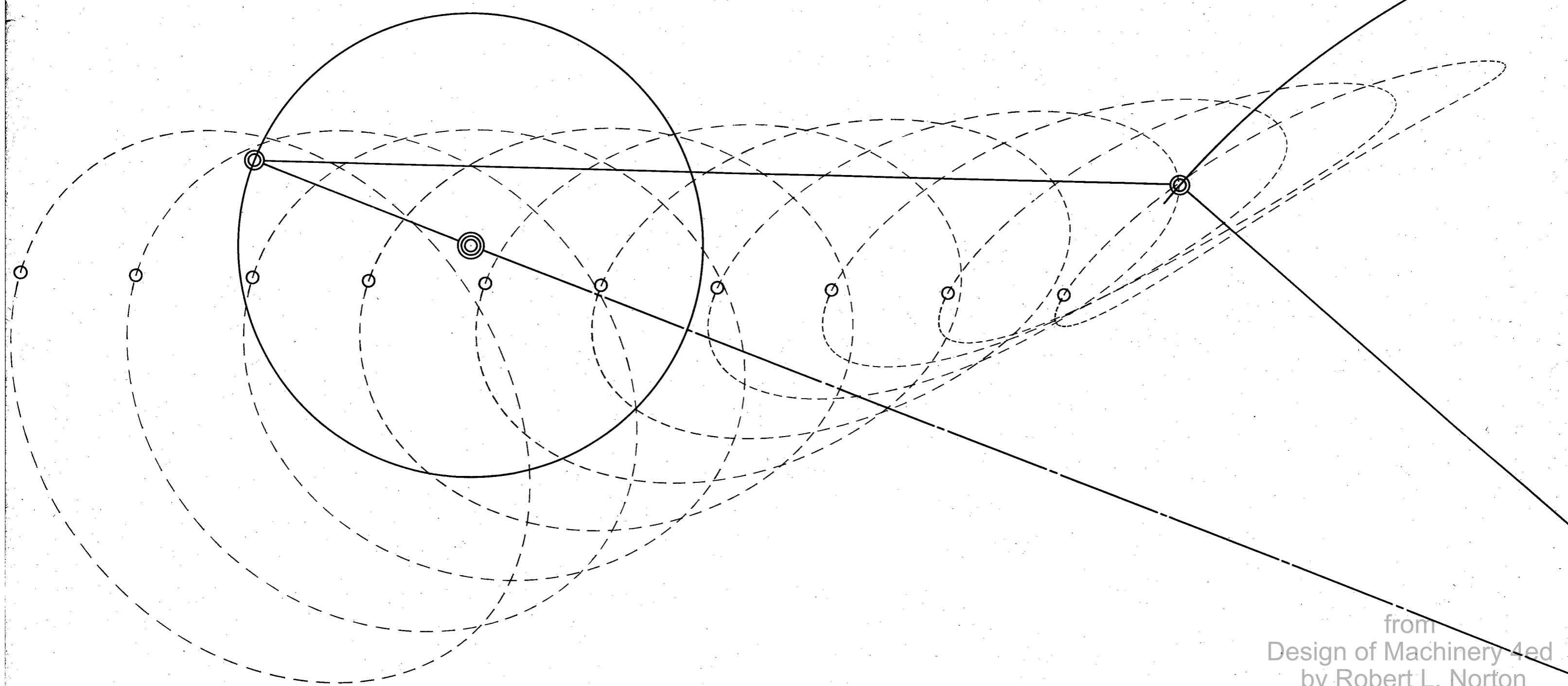
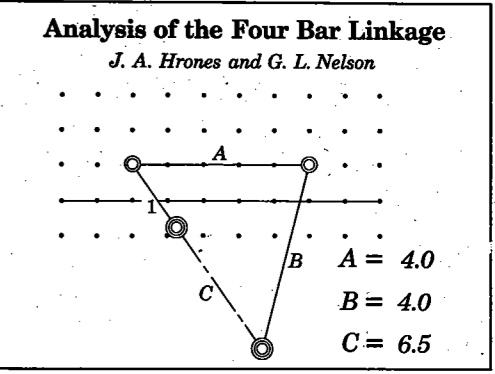

from  
 Design of Machinery 4ed  
 by Robert L. Norton  
 McGraw-Hill  
 Copyright 2008

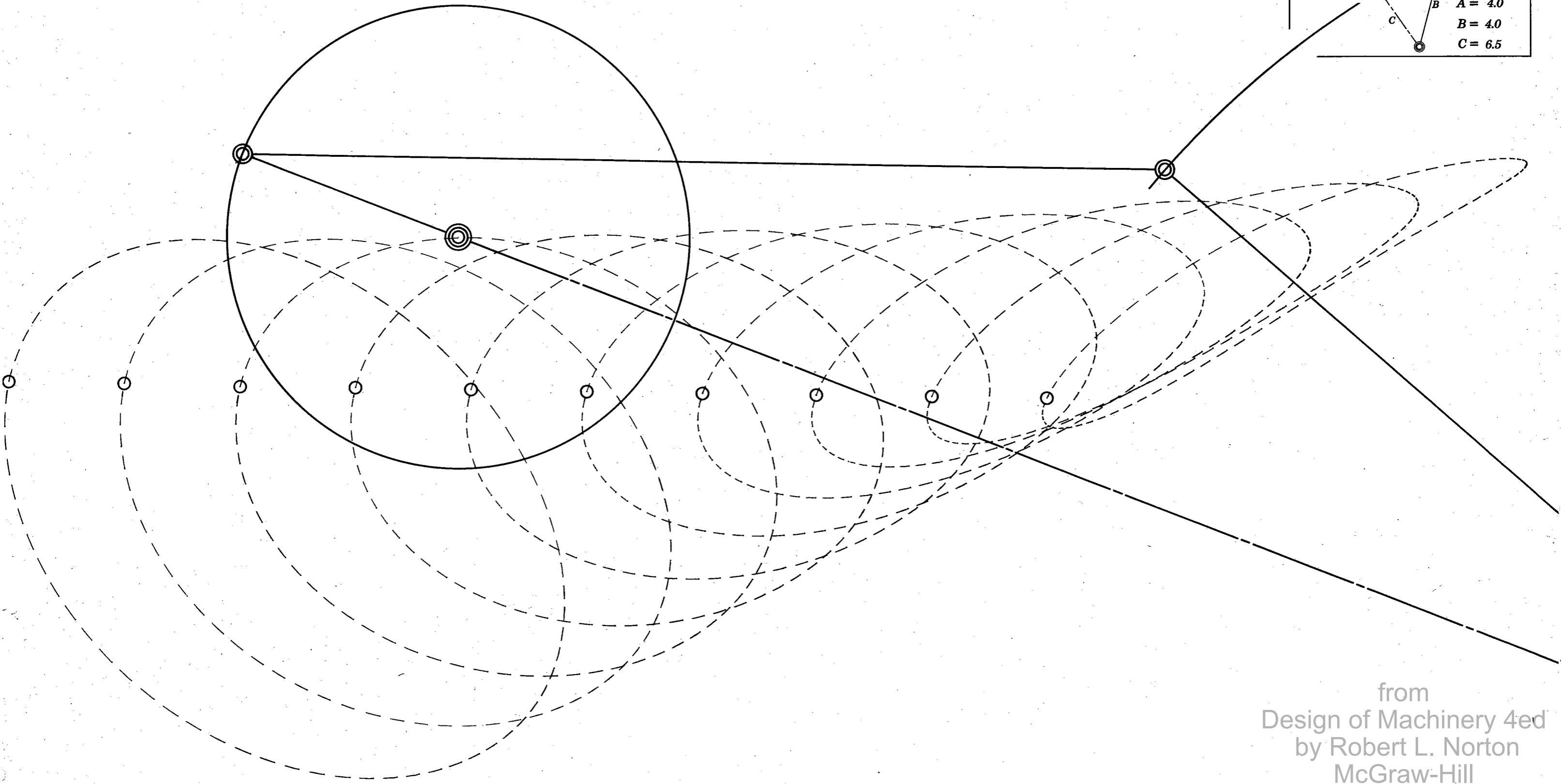
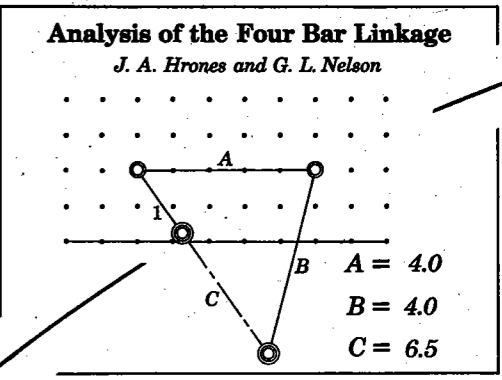

from  
Design of Machinery 4ed  
by Robert L. Norton  
McGraw-Hill  
Copyright 2008